

# Notice for TAIYO YUDEN products

Please read this notice before using the TAIYO YUDEN products.

## REMINDERS

- Product information in this catalog is as of October 2009. All of the contents specified herein are subject to change without notice due to technical improvements, etc. Therefore, please check for the latest information carefully before practical application or usage of the Products.

Please note that Taiyo Yuden Co., Ltd. shall not be responsible for any defects in products or equipment incorporating such products, which are caused under the conditions other than those specified in this catalog or individual specification.

- Please contact Taiyo Yuden Co., Ltd. for further details of product specifications as the individual specification is available.
- Please conduct validation and verification of products in actual condition of mounting and operating environment before commercial shipment of the equipment.
- All electronic components or functional modules listed in this catalog are developed, designed and intended for use in general electronics equipment.(for AV, office automation, household, office supply, information service, telecommunications, (such as mobile phone or PC) etc.). Before incorporating the components or devices into any equipment in the field such as transportation,( automotive control, train control, ship control), transportation signal, disaster prevention, medical, public information network (telephone exchange, base station) etc. which may have direct influence to harm or injure a human body, please contact Taiyo Yuden Co., Ltd. for more detail in advance. Do not incorporate the products into any equipment in fields such as aerospace, aviation, nuclear control, submarine system, military, etc. where higher safety and reliability are especially required.

In addition, even electronic components or functional modules that are used for the general electronic equipment, if the equipment or the electric circuit require high safety or reliability function or performances, a sufficient reliability evaluation check for safety shall be performed before commercial shipment and moreover, due consideration to install a protective circuit is strongly recommended at customer's design stage.

- The contents of this catalog are applicable to the products which are purchased from our sales offices or distributors (so called "TAIYO YUDEN' s official sales channel").  
It is only applicable to the products purchased from any of TAIYO YUDEN' s official sales channel.
- Please note that Taiyo Yuden Co., Ltd. shall have no responsibility for any controversies or disputes that may occur in connection with a third party's intellectual property rights and other related rights arising from your usage of products in this catalog. Taiyo Yuden Co., Ltd. grants no license for such rights.

### ■ Caution for export

Certain items in this catalog may require specific procedures for export according to "Foreign Exchange and Foreign Trade Control Law" of Japan, "U.S. Export Administration Regulations", and other applicable regulations. Should you have any question or inquiry on this matter, please contact our sales staff.  
Should you have any question or inquiry on this matter, please contact our sales staff.

# RADIAL LEADED INDUCTORS



WAVE

## FEATURES

- The LHL08~LHL16 series radial inductors are encapsulated in a resin housing which adds to the stability of the mounted part on a printed circuit board.
- The LHL08/LHL10/LHL13/LHL16 series are for high current applications.
- The LHLP10/LHLP12/LHLP16 series are shielded type for high current applications.
- LHLP10 series is also available in packaging.

## APPLICATIONS

- Ideal for use as a power choke coil in general household appliances (TVS, PDPTV, LCDTV, DVD, etc) and industrial equipment.
- Can also be used as a peaking coil in filtering applications.

## OPERATING TEMP.

- -25°C~105°C (Including self-generated heat)

## ORDERING CODE

L H △ L △ 0 8 T B 1 0 1 K ○ ○ ○

**1 Type**

LH	Radial leaded inductor
----	------------------------

**2 Configuration**

L△	Standard type Taping available
LP	Shielded type Bulk

△=Blank space

**3 External dimensions (mm max)**

08	9.0
10	11.0
12	13.0
13	14.0
16	17.0

**4 Packaging Code**

NB	Bulk (LHL)
TB	Ammo packaging (LHL)

**5 Nominal Inductance (μH)**

example	
1R0	1.0
150	15
102	1000

※R=Decimal point

**6 Inductance Tolerances (%)**

J	±5
K	±10
M	±20
N	±30

**7 Internal code**

△△△	Standard product
-----	------------------

△=Blank space

## EXTERNAL DIMENSIONS/STANDARD QUANTITY

Type	Fig.	D	H <sub>2</sub>	ℓ	F	φd	Standard Quantity (pcs)		
							Box	Bulk	Taped
LHL08		9.0 max. (0.354 max.)	9.5 max. (0.374 max.)	5.0±1.0 (0.197±0.039)	5.0±1.0 (0.197±0.039)	0.6±0.05 (0.024±0.002)	—	100	1000
LHL10		11.0 max. (0.433 max.)	14.0 max. (0.551 max.)	5.0±1.0 (0.197±0.039)	5.0±1.0 (0.197±0.039)	0.6±0.05 (0.024±0.002)	—	50	500
LHL13		14.0 max. (0.551 max.)	17.0 max. (0.669 max.)	5.0±1.0 (0.197±0.039)	7.5±1.0 (0.295±0.039)	0.8±0.05 (0.031±0.002)	—	25	500
LHL16		17.0 max. (0.669 max.)	21.0 max. (0.827 max.)	5.0±1.0 (0.197±0.039)	7.5±1.0 (0.295±0.039)	0.8±0.05 (0.031±0.002)	500	—	250
LHLP10		11.0 max. (0.433 max.)	11.0 max. (0.433 max.)	5.0±1.0 (0.197±0.039)	5.0±1.0 (0.197±0.039)	0.6±0.05 (0.024±0.004)	500	—	200
LHLP12		13.0 max. (0.512 max.)	16.0 max. (0.624 max.)	5.0±1.0 (0.197±0.039)	5.0±1.0 (0.197±0.039)	0.6±0.05 (0.024±0.004)	300	—	—
LHLP16		17.0 max. (0.669 max.)	19.0 max. (0.741 max.)	5.0±1.0 (0.197±0.039)	7.5±1.0 (0.295±0.039)	0.8±0.05 (0.031±0.004)	200	—	—

Unit : mm (inch)

## AVAILABLE INDUCTANCE RANGE

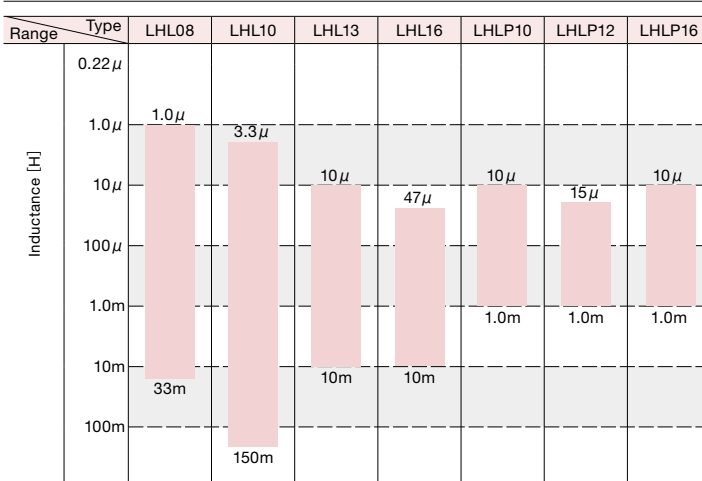

\* This catalog contains the typical specification only due to the limitation of space. When you consider purchase of our products, please check our specification. For details of each product (characteristics graph, reliability information, precautions for use, and so on), see our Web site (<http://www.ty-top.com/>) or CD catalogs.

**PART NUMBERS**

**LHL08**

Ordering code	EHS (Environmental Hazardous Substances)	Inductance [ $\mu$ H]	Inductance Tolerance	Q (min.)	Self-resonant frequency [MHz] (min.)	DC Resistance [ $\Omega$ ] (max.)	Rated current [A] (max.)	Measuring frequency [MHz]	
LHL08□1R0N	RoHS	1.0	±30%	40	76	0.013	4.7	7.96	
LHL08□1R5M	RoHS	1.5	±20%		65	0.014	4.4		
LHL08□2R2M	RoHS	2.2			56	0.017	4.1		
LHL08□2R7M	RoHS	2.7			48	0.019	3.5		
LHL08□3R3M	RoHS	3.3			41	0.021	3.2		
LHL08□3R9M	RoHS	3.9			33	0.024	3.1		
LHL08□4R7M	RoHS	4.7			30	0.025	3.0		
LHL08□5R6M	RoHS	5.6			23	0.028	2.9		
LHL08□6R8M	RoHS	6.8			21	0.030	2.8		
LHL08□8R2M	RoHS	8.2			19	0.034	2.5		
LHL08□100K	RoHS	10		±10%	65	17	0.041	2.4	2.52
LHL08□120K	RoHS	12	16			0.044	2.3		
LHL08□150K	RoHS	15	50		13	0.053	2.0		
LHL08□180K	RoHS	18			12	0.060	1.9		
LHL08□220K	RoHS	22			11	0.068	1.8		
LHL08□270K	RoHS	27			10	0.091	1.5		
LHL08□330K	RoHS	33	40		8.8	0.10	1.4		
LHL08□390K	RoHS	39			8.4	0.12	1.3		
LHL08□470K	RoHS	47			8.2	0.15	1.2		
LHL08□560K	RoHS	56			7.9	0.17	1.1		
LHL08□680K	RoHS	68	35	7.0	0.20	1.0	0.796		
LHL08□820K	RoHS	82		6.5	0.22	0.90			
LHL08□101K	RoHS	100	25	5.7	0.32	0.79			
LHL08□121K	RoHS	120		5.2	0.36	0.70			
LHL08□151K	RoHS	150	20	4.7	0.41	0.64			
LHL08□181K	RoHS	180		4.2	0.66	0.60			
LHL08□221K	RoHS	220	35	3.7	0.73	0.53			
LHL08□271K	RoHS	270		3.5	0.85	0.51			
LHL08□331K	RoHS	330	25	3.2	0.97	0.44			
LHL08□391K	RoHS	390		2.9	1.1	0.41			
LHL08□471K	RoHS	470	25	2.4	1.3	0.38			
LHL08□561K	RoHS	560		2.2	1.5	0.35			
LHL08□681K	RoHS	680		2.0	1.8	0.32			
LHL08□821K	RoHS	820	30	1.6	2.3	0.30			
LHL08□102J	RoHS	1000		1.5	2.7	0.25	0.252		
LHL08□122J	RoHS	1200	±5%	45	1.4	3.2		0.22	
LHL08□152J	RoHS	1500			55	1.3		4.1	0.20
LHL08□182J	RoHS	1800				1.2		4.8	0.19
LHL08□222J	RoHS	2200				1.1		5.6	0.16
LHL08□272J	RoHS	2700				1.0		7.5	0.15
LHL08□332J	RoHS	3300				0.85		8.5	0.14
LHL08□392J	RoHS	3900				0.78		9.7	0.11
LHL08□472J	RoHS	4700			65	0.68		14	0.10
LHL08□562J	RoHS	5600				0.62		16	0.093
LHL08□682J	RoHS	6800				0.61	18	0.092	
LHL08□822J	RoHS	8200	0.60	20		0.084			
LHL08□103J	RoHS	10000	60	0.48	32	0.070	L:1kHz Q:0.0796		
LHL08□123J	RoHS	12000		0.44	36	0.064			
LHL08□153J	RoHS	15000		0.35	62	0.051			
LHL08□183J	RoHS	18000		0.30	72	0.048			
LHL08□223J	RoHS	22000		0.28	82	0.044			
LHL08□273J	RoHS	27000		0.25	90	0.042			
LHL08□333J	RoHS	33000		0.23	100	0.040			

□ Please specify the packaging code. (TB: Taping, NB: Bulk)

**LHL10**

Ordering code	EHS (Environmental Hazardous Substances)	Inductance [ $\mu$ H]	Inductance Tolerance	Q (min.)	Self-resonant frequency [MHz] (min.)	DC Resistance [ $\Omega$ ] (max.)	Rated current [A] (max.)	Measuring frequency [MHz]
LHL10□3R3M	RoHS	3.3	±20%	50	46	0.019	4.2	7.96
LHL10□3R9M	RoHS	3.9			40	0.022	4.1	
LHL10□4R7M	RoHS	4.7			38	0.024	4.0	
LHL10□5R6M	RoHS	5.6			34	0.025	3.8	
LHL10□6R8M	RoHS	6.8			30	0.028	3.4	
LHL10□8R2M	RoHS	8.2			24	0.031	3.3	
LHL10□100K	RoHS	10	±10%	90	19	0.034	3.2	2.52
LHL10□120K	RoHS	12			16	0.038	2.8	
LHL10□150K	RoHS	15			12	0.042	2.6	
LHL10□180K	RoHS	18			9.2	0.046	2.4	
LHL10□220K	RoHS	22		60	8.6	0.061	2.1	
LHL10□270K	RoHS	27			7.1	0.069	2.0	
LHL10□330K	RoHS	33			6.8	0.078	1.9	
LHL10□390K	RoHS	39			6.7	0.085	1.8	
LHL10□470K	RoHS	47		50	6.2	0.093	1.7	
LHL10□560K	RoHS	56			5.2	0.10	1.6	

To next page

\* This catalog contains the typical specification only due to the limitation of space. When you consider purchase of our products, please check our specification. For details of each product (characteristics graph, reliability information, precautions for use, and so on), see our Web site (<http://www.ty-top.com/>) or CD catalogs.

**PART NUMBERS**

Ordering code	EHS (Environmental Hazardous Substances)	Inductance [ $\mu$ H]	Inductance Tolerance	Q (min.)	Self-resonant frequency [MHz] (min.)	DC Resistance [ $\Omega$ ] (max.)	Rated current [A] (max.)	Measuring frequency [MHz]
LHL10□680K	RoHS	68	±10%	40	4.9	0.12	1.5	2.52
LHL10□820K	RoHS	82			4.7	0.13	1.4	
LHL10□101K	RoHS	100			3.8	0.18	1.2	
LHL10□121K	RoHS	120			3.2	0.25	1.0	
LHL10□151K	RoHS	150			2.9	0.29	0.95	
LHL10□181K	RoHS	180			2.6	0.40	0.80	
LHL10□221K	RoHS	220			2.3	0.44	0.75	
LHL10□271K	RoHS	270			2.1	0.50	0.70	
LHL10□331K	RoHS	330			2.0	0.56	0.68	
LHL10□391K	RoHS	390			1.8	0.62	0.63	
LHL10□471K	RoHS	470		1.7	0.84	0.57		
LHL10□561K	RoHS	560		1.5	0.93	0.52		
LHL10□681K	RoHS	680		1.4	1.0	0.48		
LHL10□821K	RoHS	820		1.3	1.4	0.42		
LHL10□102J	RoHS	1000		1.2	1.8	0.41		
LHL10□122J	RoHS	1200		0.87	2.3	0.33		
LHL10□152J	RoHS	1500		0.83	2.7	0.30		
LHL10□182J	RoHS	1800		0.75	3.0	0.29		
LHL10□222J	RoHS	2200		0.70	3.9	0.25		
LHL10□272J	RoHS	2700		0.67	4.3	0.24		
LHL10□332J	RoHS	3300	0.56	5.8	0.21			
LHL10□392J	RoHS	3900	0.54	6.4	0.20			
LHL10□472J	RoHS	4700	0.49	7.1	0.19			
LHL10□562J	RoHS	5600	0.41	9.0	0.17			
LHL10□682J	RoHS	6800	0.38	10	0.16			
LHL10□822J	RoHS	8200	0.36	12	0.15			
LHL10□103J	RoHS	10000	0.29	19	0.12			
LHL10□123J	RoHS	12000	0.27	21	0.11			
LHL10□153J	RoHS	15000	0.24	34	0.090			
LHL10□183J	RoHS	18000	0.21	38	0.081			
LHL10□223J	RoHS	22000	0.20	43	0.075			
LHL10□273J	RoHS	27000	0.15	67	0.060			
LHL10□333J	RoHS	33000	0.14	76	0.056			
LHL10□393J	RoHS	39000	0.13	84	0.053			
LHL10□473J	RoHS	47000	0.12	96	0.050			
LHL10□563J	RoHS	56000	0.10	170	0.036			
LHL10□683J	RoHS	68000	0.095	200	0.035			
LHL10□823J	RoHS	82000	0.088	210	0.033			
LHL10□104J	RoHS	100000	0.085	240	0.031			
LHL10□124J	RoHS	120000	0.070	260	0.030			
LHL10□154J	RoHS	150000	0.069	300	0.028			

□ Please specify the packaging code. (TB: Taping, NB: Bulk)

**LHL13**

Ordering code	EHS (Environmental Hazardous Substances)	Inductance [ $\mu$ H]	Inductance Tolerance	Q (min.)	Self-resonant frequency [MHz] (min.)	DC Resistance [ $\Omega$ ] (max.)	Rated current [A] (max.)	Measuring frequency [MHz]
LHL13□100K	RoHS	10	±10%	140	19	0.023	4.5	2.52
LHL13□150K	RoHS	15			12	0.028	4.0	
LHL13□220K	RoHS	22			7.6	0.035	3.4	
LHL13□330K	RoHS	33			6.9	0.043	3.2	
LHL13□470K	RoHS	47			5.6	0.052	2.8	
LHL13□680K	RoHS	68		4.4	0.070	2.4		
LHL13□101K	RoHS	100		3.3	0.12	2.0		
LHL13□151K	RoHS	150		2.6	0.19	1.5		
LHL13□221K	RoHS	220		2.2	0.23	1.3		
LHL13□331K	RoHS	330		1.8	0.35	1.1		
LHL13□471K	RoHS	470	1.5	0.43	0.90			
LHL13□681K	RoHS	680	1.2	0.61	0.80			
LHL13□102J	RoHS	1000	1.0	1.2	0.60			
LHL13□152J	RoHS	1500	0.83	1.8	0.45			
LHL13□222J	RoHS	2200	0.70	2.2	0.40			
LHL13□332J	RoHS	3300	0.60	3.4	0.33			
LHL13□472J	RoHS	4700	0.43	4.7	0.28			
LHL13□682J	RoHS	6800	0.38	5.6	0.25			
LHL13□103J	RoHS	10000	0.30	10	0.19	L:1kHz Q:0.0796MHz		

□ Please specify the packaging code. (TB: Taping, NB: Bulk)

\* This catalog contains the typical specification only due to the limitation of space. When you consider purchase of our products, please check our specification. For details of each product (characteristics graph, reliability information, precautions for use, and so on), see our Web site (<http://www.ty-top.com/>) or CD catalogs.

**PART NUMBERS**

**LHL16**

Ordering code	EHS (Environmental Hazardous Substances)	Inductance [ $\mu$ H]	Inductance Tolerance	Q (min.)	Self-resonant frequency [MHz] (min.)	DC Resistance [ $\Omega$ ] (max.)	Rated current [A] (max.)	Measuring frequency [MHz]	
LHL16□470K	RoHS	47	±10%	70	4.5	0.046	3.7	2.52	
LHL16□680K	RoHS	68			3.9	0.054	3.3		
LHL16□101K	RoHS	100		60	2.7	0.077	2.9	0.796	
LHL16□151K	RoHS	150			2.3	0.11	2.4		
LHL16□221K	RoHS	220			1.9	0.15	2.0		
LHL16□331K	RoHS	330			1.6	0.21	1.5		
LHL16□471K	RoHS	470		30	1.4	0.28	1.3	0.252	
LHL16□681K	RoHS	680			1.2	0.35	1.1		
LHL16□102J	RoHS	1000		±5%	20	0.84	0.74	0.86	0.252
LHL16□152J	RoHS	1500				0.69	0.93	0.75	
LHL16□222J	RoHS	2200	0.56			1.4	0.60		
LHL16□332J	RoHS	3300	0.49			2.2	0.50		
LHL16□472J	RoHS	4700	0.41			2.6	0.40		
LHL16□682J	RoHS	6800	0.35			3.9	0.33		
LHL16□103J	RoHS	10000	70			0.26	7.3	0.25	

□ Please specify the packaging code. (TB: Taping, NB: Bulk)

**LHLP10NB**

Ordering code	EHS (Environmental Hazardous Substances)	Nominal Inductance [ $\mu$ H]	L Measuring frequency	Inductance Tolerance	DC Resistance [ $\Omega$ ] (max.)	Rated current [A] (max.)
LHLP10□100M	RoHS	10	2.52	±20%	0.038	2.5
LHLP10□150M	RoHS	15			0.049	2.2
LHLP10□220M	RoHS	22			0.075	1.9
LHLP10□330M	RoHS	33			0.094	1.7
LHLP10□470M	RoHS	47			0.15	1.3
LHLP10□680M	RoHS	68			0.23	1.0
LHLP10□101K	RoHS	100	0.796	±10%	0.30	0.90
LHLP10□151K	RoHS	150			0.47	0.78
LHLP10□221K	RoHS	220			0.70	0.63
LHLP10□331K	RoHS	330			0.88	0.58
LHLP10□471K	RoHS	470			1.3	0.46
LHLP10□681K	RoHS	680			1.9	0.38
LHLP10□102K	RoHS	1000	0.252		3.2	0.30

□ Please specify the packaging code. (TB: Taping, NB: Bulk)

**LHLP12NB**

Ordering code	EHS (Environmental Hazardous Substances)	Nominal Inductance [ $\mu$ H]	L Measuring frequency	Inductance Tolerance	DC Resistance [ $\Omega$ ] (max.)	Rated current [A] (max.)
LHLP12NB150M	RoHS	15	2.52	±20%	0.035	3.3
LHLP12NB220M	RoHS	22			0.050	2.7
LHLP12NB330M	RoHS	33			0.070	2.4
LHLP12NB470M	RoHS	47			0.081	2.1
LHLP12NB680M	RoHS	68			0.12	1.7
LHLP12NB101K	RoHS	100			0.16	1.6
LHLP12NB151K	RoHS	150	0.796	±10%	0.24	1.3
LHLP12NB221K	RoHS	220			0.38	0.95
LHLP12NB331K	RoHS	330			0.46	0.89
LHLP12NB471K	RoHS	470			0.69	0.74
LHLP12NB681K	RoHS	680			1.1	0.58
LHLP12NB102K	RoHS	1000			0.252	1.8

**LHLP16NB**

Ordering code	EHS (Environmental Hazardous Substances)	Nominal Inductance [ $\mu$ H]	L Measuring frequency	Inductance Tolerance	DC Resistance [ $\Omega$ ] (max.)	Rated current [A] (max.)
LHLP16NB100M	RoHS	10	1kHz	±20%	0.019	5.2
LHLP16NB150M	RoHS	15			0.025	5.1
LHLP16NB220M	RoHS	22			0.027	4.6
LHLP16NB330M	RoHS	33			0.035	4.0
LHLP16NB470K	RoHS	47			0.045	3.4
LHLP16NB680K	RoHS	68			0.062	3.1
LHLP16NB101K	RoHS	100		±10%	0.091	2.3
LHLP16NB151K	RoHS	150			0.14	1.9
LHLP16NB221K	RoHS	220			0.20	1.5
LHLP16NB331K	RoHS	330			0.31	1.3
LHLP16NB471K	RoHS	470			0.47	1.0
LHLP16NB681K	RoHS	680			0.58	0.98
LHLP16NB102K	RoHS	1000			0.94	0.74

\* This catalog contains the typical specification only due to the limitation of space. When you consider purchase of our products, please check our specification. For details of each product (characteristics graph, reliability information, precautions for use, and so on), see our Web site (<http://www.ty-top.com/>) or CD catalogs.

# ELECTRICAL CHARACTERISTICS

## DC Bias characteristics

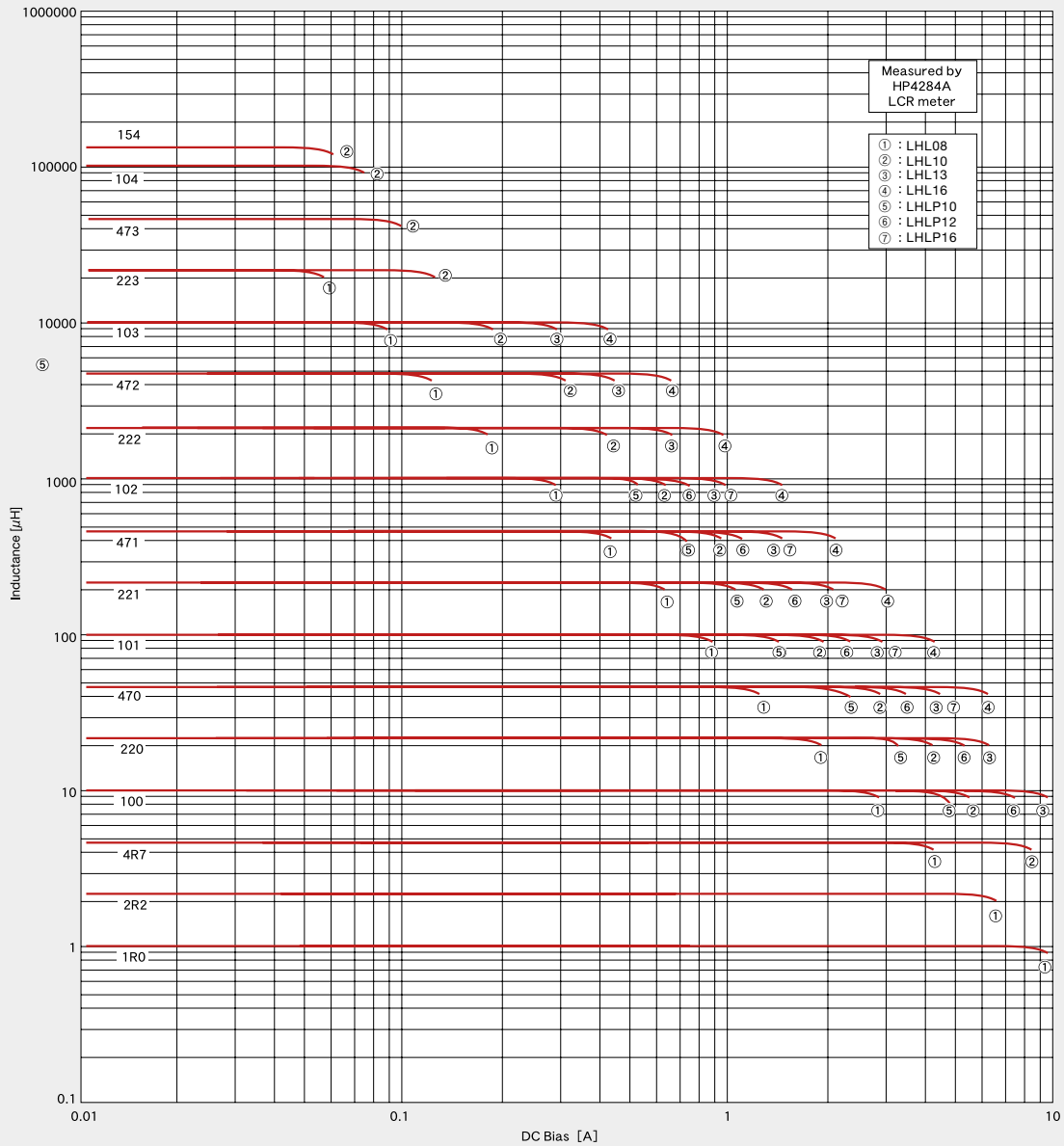

## Temperature characteristics

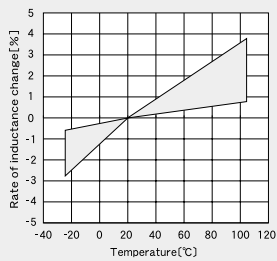

## Q-vs-Frequency characteristics

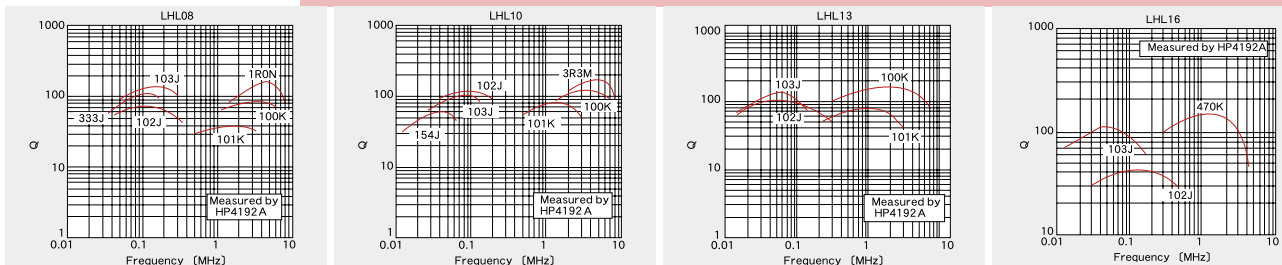

\* This catalog contains the typical specification only due to the limitation of space. When you consider purchase of our products, please check our specification. For details of each product (characteristics graph, reliability information, precautions for use, and so on), see our Web site (<http://www.ty-top.com/>) or CD catalogs.

**PACKAGING**

① Minimum Quantity

Type (EIA)	Standard quantity (pcs)		
	Box	Bulk	Taped
LHL 08	—	100	1000
LHL 10	—	50	500
LHL 13	—	25	500
LHL 16	500	—	250
LHLP10	500	—	200
LHLP12NB	300	—	—
LHLP16NB	200	—	—

② Bulk dimensions

● LHL08~16

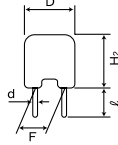

Type	Dimensions				
	φD(max)	H <sub>2</sub> (max)	F*	ℓ	φd
LHL08	9.0 (0.354)	9.5 (0.374)	5.0±1.0 (0.197±0.039)	5.0±1.0 (0.197±0.039)	0.6±0.05 (0.024±0.002)
LHL10	11.0 (0.433)	14.0 (0.551)	5.0±1.0 (0.197±0.039)	5.0±1.0 (0.197±0.039)	0.6±0.05 (0.024±0.002)
LHL13	14.0 (0.551)	17.0 (0.669)	7.5±1.0 (0.295±0.039)	5.0±1.0 (0.197±0.039)	0.8±0.05 (0.031±0.002)
LHL16	17.0 (0.669)	21.0 (0.827)	7.5±1.0 (0.295±0.039)	5.0±1.0 (0.197±0.039)	0.8±0.05 (0.031±0.002)

\*Measured at the base of the leads.

Unit : mm (inch)

● LHL10~16

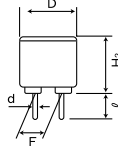

Type	Dimensions				
	φD(max)	H <sub>2</sub> (max)	F*	ℓ	φd
LHLP10	11.0 (0.433)	11.0 (0.433)	5.0±1.0 (0.197±0.039)	5.0±1.0 (0.197±0.039)	0.6±0.05 (0.024±0.004)
LHLP12	13.0 (0.512)	16.0 (0.624)	5.0±1.0 (0.197±0.039)	5.0±1.0 (0.197±0.039)	0.6±0.05 (0.024±0.004)
LHLP16	17.0 (0.669)	19.0 (0.741)	7.5±1.0 (0.295±0.039)	5.0±1.0 (0.197±0.039)	0.8±0.05 (0.031±0.004)

\*Measured at the base of the leads.

Unit : mm (inch)

● LHL08~16

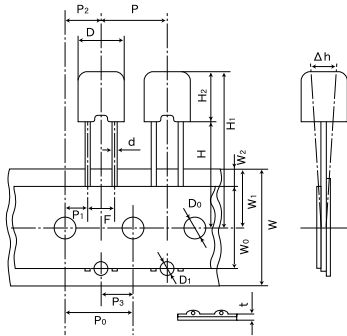

	LHL08	LHL10	LHL13	LHL16
D	φ9.0 max (φ0.354 max)	φ11.0 max (φ0.433 max)	φ14.0 max (φ0.551 max)	φ17.0 max (φ0.669 max)
H <sub>1</sub>	30.5 max (1.20 max)	34.0 max (1.34 max)	37.0 max (1.46 max)	41.0 max (1.61 max)
H	18.0 <sup>+2.0</sup> <sub>-0.0</sub> (0.709 <sup>+0.079</sup> <sub>-0.000</sub> )	18.0 <sup>+2.0</sup> <sub>-0.0</sub> (0.709 <sup>+0.079</sup> <sub>-0.000</sub> )	18.0 <sup>+2.0</sup> <sub>-0.0</sub> (0.709 <sup>+0.079</sup> <sub>-0.000</sub> )	18.0 <sup>+2.0</sup> <sub>-0.0</sub> (0.709 <sup>+0.079</sup> <sub>-0.000</sub> )
H <sub>2</sub>	9.5 max (0.374 max)	14.0 max (0.551 max)	17.0 max (0.669 max)	21.0 max (0.827 max)

	LHL08	LHL10	LHL13	LHL16
P	12.7±1.0 (0.500±0.039)	12.7±1.0 (0.500±0.039)	15.0±1.0 (0.591±0.039)	30.0±1.0 (1.18±0.039)
P <sub>0</sub>	12.7±0.3 <sup>#1</sup> (0.500±0.012)	12.7±0.3 <sup>#1</sup> (0.500±0.012)	15.0±0.3 <sup>#1</sup> (0.591±0.012)	15.0±0.3 <sup>#1</sup> (0.591±0.012)
P <sub>1</sub>	3.85±0.7 (0.152±0.028)	3.85±0.7 (0.152±0.028)	3.75±0.7 (0.148±0.028)	3.75±0.7 (0.148±0.028)
P <sub>2</sub>	6.35±1.3 (0.250±0.051)	6.35±1.3 (0.250±0.051)	7.50±1.3 (0.295±0.051)	7.50±1.3 (0.295±0.051)
F	5.0 <sup>+0.8</sup> <sub>-0.2</sub> (0.197 <sup>+0.031</sup> <sub>-0.008</sub> )	5.0 <sup>+0.8</sup> <sub>-0.2</sub> (0.197 <sup>+0.031</sup> <sub>-0.008</sub> )	7.50 <sup>+0.8</sup> <sub>-0.2</sub> (0.295 <sup>+0.031</sup> <sub>-0.008</sub> )	7.50±0.5 (0.295±0.020)
h	0.0±2.0 (0.0±0.079)	0.0±2.0 (0.0±0.079)	0.0±2.0 (0.0±0.079)	0.0±2.0 (0.0±0.079)
W	18.0 <sup>+1.0</sup> <sub>-0.5</sub> (0.709 <sup>+0.039</sup> <sub>-0.020</sub> )	18.0 <sup>+1.0</sup> <sub>-0.5</sub> (0.709 <sup>+0.039</sup> <sub>-0.020</sub> )	18.0 <sup>+1.0</sup> <sub>-0.5</sub> (0.709 <sup>+0.039</sup> <sub>-0.020</sub> )	18.0 <sup>+1.0</sup> <sub>-0.5</sub> (0.709 <sup>+0.039</sup> <sub>-0.020</sub> )
W <sub>0</sub>	12.5 min (0.492 min)	12.5 min (0.492 min)	12.5 min (0.492 min)	12.5 min (0.492 min)
W <sub>1</sub>	9.0±0.5 (0.354±0.020)	9.0±0.5 (0.354±0.020)	9.0±0.5 (0.354±0.020)	9.0±0.5 (0.354±0.020)
W <sub>2</sub>	3.0 max <sup>#2</sup> (0.118 max)	3.0 max <sup>#2</sup> (0.118 max)	3.0 max <sup>#2</sup> (0.118 max)	3.0 max <sup>#2</sup> (0.118 max)
D <sub>0</sub>	φ4.0±0.2 (φ0.158±0.008)	φ4.0±0.2 (φ0.158±0.008)	φ4.0±0.2 (φ0.158±0.008)	φ4.0±0.2 (φ0.158±0.008)
φd	φ0.6±0.05 (φ0.024±0.002)	φ0.6±0.05 (φ0.024±0.002)	φ0.8±0.05 (φ0.031±0.002)	φ0.8±0.05 (φ0.031±0.002)
t	0.6±0.3 (0.024±0.012)	0.6±0.3 (0.024±0.012)	0.6±0.3 (0.024±0.012)	0.6±0.3 (0.024±0.012)
D <sub>1</sub>	φ1.8 (0.071)	φ1.8 (0.071)	φ1.8 (0.071)	—
P <sub>3</sub>	6.35 (0.25)	6.35 (0.25)	7.50 (0.25)	—

※1 Accumulated error for 20 pitches is 1mm.

Unit : mm (inch)

※2 Bonding tape must not protrude from the base tape.

● LHL10TB

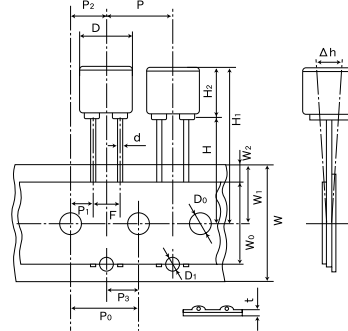

Type	Symbol	Dimensions	Symbol	Dimensions
LHLP10	D	φ11.0 max (φ0.433 max)	W	18.0 <sup>+1.0</sup> <sub>-0.5</sub> (0.709 <sup>+0.039</sup> <sub>-0.020</sub> )
	H <sub>1</sub>	32.0 max (1.26 max)	W <sub>0</sub>	12.5 min (0.492 min)
	H	18.0 <sup>+2.0</sup> <sub>-0.0</sub> (0.709 <sup>+0.079</sup> <sub>-0.000</sub> )	W <sub>1</sub>	9.0±0.5 (0.354±0.020)
	H <sub>2</sub>	11.0 max (0.433 max)	W <sub>2</sub>	3.0 max <sup>#2</sup> (0.118 max)
	P	12.7±1.0 (0.500±0.039)	D <sub>0</sub>	φ4.0±0.2 (φ0.158±0.008)
	P <sub>0</sub>	12.7±0.3 <sup>#1</sup> (0.500±0.012)	φd	φ0.6±0.05 (φ0.024±0.002)
	P <sub>1</sub>	3.85±0.7 (0.152±0.028)	t	0.6±0.3 (0.024±0.012)
	P <sub>2</sub>	6.35±1.3 (0.250±0.051)	D <sub>1</sub>	φ1.8 (0.071)
	F	5.0 <sup>+0.8</sup> <sub>-0.2</sub> (0.197 <sup>+0.031</sup> <sub>-0.008</sub> )	P <sub>3</sub>	6.35 (0.25)
	h	0.0±2.0 (0.0±0.079)	Unit : mm (inch)	

※1 Accumulated error for 20 pitches is 1mm.

※2 Bonding tape must not protrude from the base tape.

\* This catalog contains the typical specification only due to the limitation of space. When you consider purchase of our products, please check our specification. For details of each product (characteristics graph, reliability information, precautions for use, and so on), see our Web site (<http://www.ty-top.com/>) or CD catalogs.

## RELIABILITY DATA

1. Operating temperature Range	
LA Type	-25~+105°C
CAL45 Type	
LHL□□□	
FBA/FBR	-25~+85°C
FL05□ Type	-25~+105°C
FL06BT Type	

**[Test Method and Remarks]**  
 LA·CA·FL : Including self-generated heat  
 LHL□□□ : Including self-generated heat

2. Storage temperature Range	
LA Type	-40~+85°C
CAL45 Type	
LHL□□□	
FBA/FBR	
FL05□ Type	
FL06BT Type	

3. Rated current	
LA Type	Within the specified tolerance
CAL45 Type	
LHL□□□	
FBA/FBR	
FL05□ Type	
FL06BT Type	

**[Test Method and Remarks]**  
 LA, CA : The maximum DC value having inductance within 10% and temperature increase within 40°C (LA:20°C) by the application of DC bias.  
 LHL□□□ : The maximum DC value having inductance decrease within 10% (LHLC08, LHLC10 : within 30%) and temperature increase within the following specified temperature by the application of DC bias.  
     Reference temperature : 25°C (LHL08, LHL10, LHL13)  
                                   : 30°C (LHL16, LHLP□□)  
                                   : 40°C (LHLC08, LHLC10)  
 FB : No disconnection or appearance abnormality by continuous current application for 30 min. Change after the application shall be within ±20% of the initial value.  
     This is not guaranteed for electrical characteristics during current application.  
 FL : The maximum DC value having temperature rise within specified value.

4. Impedance	
LA Type	Within the specified tolerance
CAL45 Type	
LHL□□□	
FBA/FBR	
FL05□ Type	
FL06BT Type	

**[Test Method and Remarks]**  
 FB : Measuring equipment : Impedance analyzer (HP4191A) or its equivalent  
     Measuring frequency : Specified frequency  
 FL06BT : Measuring equipment : 4291A (HP) or its equivalent  
     Measuring frequency : Specified frequency

5. Inductance	
LA Type	Within the specified tolerance
CAL45 Type	
LHL□□□	
FBA/FBR	
FL05□ Type	
FL06BT Type	

**[Test Method and Remarks]**  
 LA, CA : Measuring equipment : LCR meter (HP4285A + HP42851A or its equivalent)  
     Measuring frequency : Specified frequency  
 LHL□□□ : Measuring equipment : LCR meter (HP4285A+HP42851A or its equivalent)  
                                   LCR meter (HP4263A) or its equivalent (at 1kHz)  
     Measuring frequency : Specified frequency  
 FL05R□ : Measuring equipment : HP4262A or its equivalent  
     Measuring frequency : 1kHz

6. Q	
LA Type	Within the specified tolerance
CAL45 Type	
LHL□□□	
FBA/FBR	
FL05□ Type	
FL06BT Type	

**[Test Method and Remarks]**  
 LA : Measuring equipment : LCR meter (HP4285A + HP42851A or its equivalent)  
     Measuring frequency : Specified frequency  
 LHL□□□ (except LHLP) : Measuring equipment : LCR meter (HP4285A+HP42851A or its equivalent)  
                                   LCR meter (HP4263A) or its equivalent (at 1kHz)  
     Measuring frequency : Specified frequency

\* This catalog contains the typical specification only due to the limitation of space. When you consider purchase of our products, please check our specification.  
 For details of each product (characteristics graph, reliability information, precautions for use, and so on), see our Web site (<http://www.ty-top.com/>) or CD catalogs.

## RELIABILITY DATA

### 7. DC Resistance

LA Type	Within the specified tolerance
CAL45 Type	
LHL□□□	
FBA/FBR	
FL05□ Type	
FL06BT Type	

#### [Test Method and Remarks]

LA, CA : Measuring equipment : low ohmmeter (A&D AD5812 or its equivalent)  
 LHL□□□・FB・FL : Measuring equipment : DC ohmmeter

### 8. Self resonance frequency

LA Type	Within the specified tolerance
CAL45 Type	
LHL□□□	
FBA/FBR	
FL05□ Type	
FL06BT Type	

#### [Test Method and Remarks]

LA : Measuring equipment : Network analyzer (Anritsu MS620J or its equivalent)  
 LHL□□□ (except LHLP) : Measuring equipment : (HP4191A, 4192A) its equivalent

### 9. Temperature characteristic

LA Type	$\Delta L/L$ : Within $\pm 5\%$
CAL45 Type	
LHL□□□	$\Delta L/L$ : Within $\pm 7\%$ (except LHLP16 : Within $\pm 20\%$ )
FBA/FBR	
FL05□ Type	
FL06BT Type	

#### [Test Method and Remarks]

LA : Change of maximum inductance deviation in step 1 to 5

Step	Temperature (°C)
1	20
2	-25 (Minimum operating temperature)
3	20 (Standard temperature)
4	+85 (Maximum operating temperature)
5	20

LHL□□□ : Change of maximum inductance deviation in step 1 to 5

Temperature at step 1 : 20°C  
 Temperature at step 2 : Minimum operating temperature  
 Temperature at step 3 : 20°C (Standard temperature)  
 Temperature at step 4 : Maximum operating temperature  
 Temperature at step 5 : 20°C

### 10. Terminal strength : tensile force

LA Type	No abnormality such as cut lead, or looseness.
CAL45 Type	
LHL□□□	
FBA/FBR	
FL05□ Type	
FL06BT Type	

#### [Test Method and Remarks]

LA : Apply the stated tensile force progressively in the direction to draw terminal.

force (N)	duration (s)
25	5

CA : Apply the stated tensile force progressively in the direction to draw terminal.

force (N)	duration (s)
10	10

LHL□□□ : Apply the stated tensile force progressively in the direction to draw terminal.

Nominal wire diameter tensile $\phi d$ (mm)	force (N)	duration (s)
$0.3 < \phi d \leq 0.5$	5	30±5
$0.5 < \phi d \leq 0.8$	10	
$0.8 < \phi d \leq 1.2$	25	

FBA/FBR : A bead shall be fixed and static loaded  $20 \pm 1N$  ( $2.0 \pm 0.1$  kgf) in axial direction of lead wire in  $10 \pm 1$  seconds.

FL05R□ : Fix the component in the direction to draw terminal, and gradually apply the tensile force of 4.9N.

### 11. Over current

LA Type	No emission of smoke no firing.
CAL45 Type	
LHL□□□	There shall be no scorch or short of wire. LHLC08, LHLC10 : There shall be no firing.
FBA/FBR	
FL05□ Type	
FL06BT Type	

#### [Test Method and Remarks]

LHL□□□/LA・CAL45 Type : Measuring current : Rated current×2  
 Duration : 5 min.  
 Number of measuring : one time

## RELIABILITY DATA

### 12. Terminal strength : bending

LA Type	No abnormality such as cut lead, or looseness.
CAL45 Type	
LHL□□□	
FBA/FBR	
FL05□ Type	
FL06BT Type	

#### [Test Method and Remarks]

LA, CA : Suspend a mass at the end the terminal, incline the body though angel of 90 and return it to initial position. This operation is done over a period of 2-3 sec. Then second bend in the opposite direction shall be made.  
Number of bends : Two times.

Nominal wire diameter tensile $\phi d$ (mm)	Bending force (N)	Mass reference weight (kg)
$0.5 < \phi d \leq 0.8$	5	0.50

LH·FB : Suspend a mass at the end the terminal, incline the body though angel of 90 and return it to initial position. This operation is done over a period of 2-3 sec. Then second bend in the opposite direction shall be made.  
Number of bends : Two times.

Nominal wire diameter tensile $\phi d$ (mm)	Bending force (N)	Mass reference weight (kg)
$0.3 < \phi d \leq 0.5$	2.5	0.25
$0.5 < \phi d \leq 0.8$	5	0.5
$0.8 < \phi d \leq 1.2$	10	1.0

### 13. Insulation resisance : between the terminals and body

LA Type	100M $\Omega$ min.
CAL45 Type	
LHL□□□	
FBA/FBR	
FL05□ Type	
FL06BT Type	

#### [Test Method and Remarks]

LHL□□□ : Applied voltage : 500 VDC  
Duration : 60 sec.

### 14. Insulation resistance : between terminals and core

LA Type	1M $\Omega$ min. (Other than materail code MA)
CAL45 Type	
LHL□□□	
FBA/FBR	
FL05□ Type	
FL06BT Type	

#### [Test Method and Remarks]

FBA·FBR : Applied voltage : 100 VDC  
Duration : 60±5 sec.

### 15. Withstanding : between the terminals and body

LA Type	No abnormality such as insulation damage
CAL45 Type	
LHL□□□	
FBA/FBR	
FL05□ Type	
FL06BT Type	

#### [Test Method and Remarks]

LHL□□□ : Accoding to JIS C5102. 7. 1. 3 (C)  
Metal global method  
Applied voltage : 500 VDC  
Duration : 60 sec.

### 16. DC bias characteristic

LA Type	$\Delta L/L$ : Within -10%
CAL45 Type	
LHL□□□	
FBA/FBR	
FL05□ Type	
FL06BT Type	

#### [Test Method and Remarks]

LA, CA : Measure inductance with appliation of rated current using LCR meter to compare it with the initial value.

### 17. Body strength

LA Type	No abnormality as damage.
CAL45 Type	
LHL□□□	
FBA/FBR	
FL05□ Type	
FL06BT Type	

#### [Test Method and Remarks]

LA : Applied force : 30N  
Duration : 10 sec.  
Speed : Shall attain to specified force in 2 sec.

CAL45 : Applied force : 50N  
Duration : 10 sec.  
Speed : Shall attain to specified force in 2 sec.

FBA : Applied force : 50±3N  
Duration : 30±1 sec.

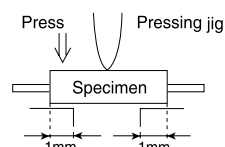

\* This catalog contains the typical specification only due to the limitation of space. When you consider purchase of our products, please check our specification.  
For details of each product (characteristics graph, reliability information, precautions for use, and so on), see our Web site (<http://www.ty-top.com/>) or CD catalogs.

## RELIABILITY DATA

18. Resitance to vibration	
LA Type	$\Delta L/L$ : Within $\pm 5\%$ Q : 30min
CAL45 Type	$\Delta L/L$ : Within $\pm 5\%$
LHL□□□	Appearance : No abnormality $\Delta L/L$ : Within $\pm 5\%$ Q change : Within $\pm 30\%$ (LHLP : only $\Delta L/L$ )
FBA/FBR	Appearance : No abnormality Impedance change : Within $\pm 20\%$
FL05□ Type	
FL06BT Type	

**[Test Method and Remarks]**

LA, CA : Directions : 2 hrs each in X, Y and Z directions total : 6hrs.  
 Frequency range : 10 to 55 to 10Hz (1min.)  
 Amplitude : 1.5mm  
 Mounting method : Soldering onto printed board.  
 Recovery : At least 1hr of recovery under the standard condition after the test, followed by the measurement within 2hrs.

LHL□□□·FB : Directions : 2 hrs each in X, Y and Z directions total : 6hrs.  
 Frequency range : 10 to 55 to 10Hz (1min.)  
 Amplitude : 1.5mm (But don't exceed acceleration  $196\text{m/s}^2$  (two power))  
 Mounting method : Soldering onto printed board.

19. Resistance to shock	
LA Type	No significant abnormality in appearance
CAL45 Type	
LHL□□□	
FBA/FBR	
FL05□ Type	
FL06BT Type	

**[Test Method and Remarks]**

LA, CA : Drop test  
 Impact material : concrete or vinyl tile  
 Height : 1m  
 Total number of drops : 10 times

20. Solderability	
LA Type	At least 75% of terminal electrode is covered by new solder.
CAL45 Type	
LHL□□□	
FBA/FBR	
FL05□ Type	
FL06BT Type	

**[Test Method and Remarks]**

LA, CA : Solder temperature :  $230\pm 5^\circ\text{C}$   
 Duration :  $2\pm 0.5$  sec.

LHL□□□ : Solder temperature :  $235\pm 5^\circ\text{C}$   
 Duration :  $2\pm 0.5$  sec.  
 Immersion depth : Up to 1.5mm from bottom of case.

FB : Solder temperature :  $230\pm 5^\circ\text{C}$   
 Duration :  $3\pm 1$  sec.  
 Immersion depth : Up to 1.5mm from terminal root.

FL05R□ : Solder temperature :  $230\pm 5^\circ\text{C}$   
 Duration :  $2\pm 0.5$  sec.  
 Immersion depth : Up to 2 to 2.5mm from terminal root.

FL06BT : Solder temperature :  $230\pm 5^\circ\text{C}$   
 Duration :  $3\pm 1$  sec.  
 Immersion depth : Up to 0.5 to 1.0mm from terminal root.

21. Resitance to soldering heat	
LA Type	No significant abnormality in appearance
CAL45 Type	$\Delta L/L$ : Within $\pm 5\%$
LHL□□□	No significant abnormality in appearance Inductance change : Within $\pm 5\%$ Q change : Within $\pm 30\%$ (LHLP : only $\Delta L/L$ )
FBA/FBR	No significant abnormality in appearance Impedance change : Within $\pm 20\%$
FL05□ Type	Refer to individual specification
FL06BT Type	No significant abnormality in appearance Impedance change : Within $\pm 20\%$

**[Test Method and Remarks]**

LA, CA : Solder temperature : (CA)  $270\pm 5^\circ\text{C}$ , (LA)  $260\pm 5^\circ\text{C}$   
 Duration :  $5\pm 0.5$  sec. One time  
 Immersed conditions : Inserted into substrate with  $t=1.6\text{mm}$   
 Recovery : At least 1hr of recovery under the standard condition after the test, followed by the measurement within 2hrs.

LHL□□□ : Solder bath method : Solder temperature :  $260\pm 5^\circ\text{C}$   
 Duration :  $10\pm 1$  sec.  
 Up to 1.5mm from bottom of case.

Manual soldering : Solder temperature :  $350\pm 10^\circ\text{C}$  (At the tip of soldering iron)  
 Duration :  $5\pm 1$  sec.  
 Up to 1.5mm from bottom of case.

Caution : No excessive pressing shall be applied to terminald.  
 Recovery : 4 to 24hrs of recovery under the standard condition after the test.

FB : Solder bath method : Condition 1 : Solder temperature :  $260\pm 5^\circ\text{C}$   
 Duration :  $10\pm 1$  sec.  
 Immersion depth : Up to 1.5mm from terminal root.  
 Condition 2 : Solder temperature :  $350\pm 5^\circ\text{C}$   
 Duration :  $3\pm 1$  sec.  
 Immersion depth : Up to 1.5mm from terminal root.  
 Recovery : 3hrs of recovery under the standard condition after the test.

FL : Solder condition :  $260\pm 5^\circ\text{C}$   $10\pm 1$  sec.  
 Immersion depth : Up to 0.5 to 1.0mm from terminal root.  
 Recovery : 3hrs of recovery under the standard condition after the test.

\* This catalog contains the typical specification only due to the limitation of space. When you consider purchase of our products, please check our specification.  
 For details of each product (characteristics graph, reliability information, precautions for use, and so on), see our Web site (<http://www.ty-top.com/>) or CD catalogs.

## RELIABILITY DATA

22. Resisistance to solvent	
LA Type	Please avoid the ultrasonic cleaning of this product.
CAL45 Type	
LHL□□□	
FBA/FBR	No significant abnormality in appearance      Impedance change : Within ±20%
FL05□ Type	
FL06BT Type	

**[Test Method and Remarks]**

FB : Solvent temperature : 20~25°C  
 Duration : 30±5 sec.  
 Solvent type : Acetone, trichloroethylene  
 Recovery : 3hrs of recovery under the standard condition after the test.

23. Thermal shock	
LA Type	△L/L : Within ±10%    Q : 30min
CAL45 Type	△L/L : Within ±10%
LHL□□□	Appearance : No abnormality      Inductance change : Within ±10%      Q change : Within ±30% (LHLP : only △L/L)
FBA/FBR	Appearance : No abnormality      Impedance change : Within ±20%
FL05□ Type	Refer to individual specification
FL06BT Type	Appearance : No abnormality      Impedance change : Within ±20%

**[Test Method and Remarks]**

LA, CA : Conditions for 1cycle

Step	Temperature (°C)	Duration (min.)
1	-25 <sup>+0</sup> <sub>-3</sub>	30±3
2	Room temperature	Within 3
3	+85 <sup>+2</sup> <sub>-0</sub>	30±3
4	Room temperature	Within 3

Number of cycles : 5 cycles  
 Recovery : At least 1hr of recovery under the standard condition after the removal from test chamber, followed by the measurement within 2hrs.

LHL□□□·FB : Accoding to JIS C0025

Conditions for 1 cycle

Step	Temperature (°C)	Duration (min.)
1	Minimum operating temperature <sup>+0</sup> <sub>-3</sub>	30±3
2	Room temperature	Within 3
3	Minimum operating temperature <sup>+2</sup> <sub>-0</sub>	30±3
4	Room temperature	Within 3

Number of cycles : 10 cycles (LHL□□□)  
 : 5 cycles (FBA, FBR)  
 Recovery : 4 to 24hrs of recovery under the standard condition after the removal from the test chamber. (LHL□□□)  
 : 3hrs of recovery under the standard condition after the removal from the test chamber. (FBA, FBR)

FL : Accoding to JIS C0025

Conditions for 1 cycle

Step	Temperature (°C)	Duration (min.)
1	-25 <sup>+0</sup> <sub>-3</sub>	30±3
2	Room temperature	Within 3
3	+85 <sup>+2</sup> <sub>-0</sub>	30±3
4	Room temperature	Within 3

Number of cycles : 10 cycles  
 Recovery : 1 to 2hrs of recovery under the standard condition after the removal from the test chamber.

24. Damp heat	
LA Type	△L/L : Within ±10%    Q : 30min
CAL45 Type	△L/L : Within ±10%
LHL□□□	
FBA/FBR	Appearance : No abnormality      Impedance change : Within ±20%
FL05□ Type	
FL06BT Type	

**[Test Method and Remarks]**

LA, CA : Temperature : 40±2°C  
 Humidity : 90~95%RH  
 Duration : 1000 hrs  
 Recovery : At least 1hr of recovery under the standard removal from test chamber, followed by the measurement within 2hrs.

FB : Temperature : 60±2°C  
 Humidity : 90~95%RH  
 Duration : 1000 hrs  
 Recovery : 1 to 2hrs of recovery under the standard condition after the removal from the test chamber.

\* This catalog contains the typical specification only due to the limitation of space. When you consider purchase of our products, please check our specification. For details of each product (characteristics graph, reliability information, precautions for use, and so on), see our Web site (<http://www.ty-top.com/>) or CD catalogs.

## RELIABILITY DATA

25. Loading under damp heat	
LA Type	$\Delta L/L$ : Within $\pm 10\%$ Q : $\pm 30\text{min}$
CAL45 Type	$\Delta L/L$ : Within $\pm 10\%$
LHL□□□	Appearance : No abnormality Inductance change : Within $\pm 10\%$ Q change : Within $\pm 30\%$ (LHLP : only $\Delta L/L$ )
FBA/FBR	
FL05□ Type	Refer to individual specification
FL06BT Type	Appearance : No abnormality Impedance change : Within $\pm 20\%$
[Test Method and Remarks]	
LA, CA	: Temperature : $40\pm 2^\circ\text{C}$ Humidity : $90\sim 95\%\text{RH}$ Duration : 1000 hrs Applied current : Rated current Recovery : At least 1hr of recovery under the standard removal from test chamber, followed by the measurement within 2hrs.
LHL□□□	: Temperature : $40\pm 2^\circ\text{C}$ Humidity : $90\sim 95\%\text{RH}$ Duration : $1000\pm 24$ hrs Applied current : Rated current Recovery : 1 to 2hrs of recovery under the standard condition after the removal from the test chamber.
FL	: Temperature : $60\pm 3^\circ\text{C}$ Humidity : $90\sim 95\%\text{RH}$ Duration : 500 (+12, -0) hrs Applied current : Rated current Recovery : 1 to 2hrs of recovery under the standard condition after the removal from the test chamber.
26. Loading at high temperature	
LA Type	$\Delta L/L$ : Within $\pm 10\%$ Q : $\pm 30\text{min}$
CAL45 Type	$\Delta L/L$ : Within $\pm 10\%$
LHL□□□	
FBA/FBR	
FL05□ Type	
FL06BT Type	
[Test Method and Remarks]	
LA, CA	: Temperature : $85\pm 2^\circ\text{C}$ Duration : 1000 hrs Applied current : Rated current Recovery : At least 1hr of recovery under the standard removal from test chamber, followed by the measurement within 2hrs.
27. Low temperature life test	
LA Type	$\Delta L/L$ : Within $\pm 10\%$ Q : $\pm 30\text{min}$
CAL45 Type	$\Delta L/L$ : Within $\pm 10\%$
LHL□□□	Appearance : No abnormality Inductance change : Within $\pm 10\%$ Q change : Within $\pm 30\%$ (LHLP : only $\Delta L/L$ )
FBA/FBR	
FL05□ Type	Refer to individual specification
FL06BT Type	Appearance : No abnormality Impedance change : Within $\pm 20\%$
[Test Method and Remarks]	
LA, CA	: Temperature : $-25\pm 2^\circ\text{C}$ Duration : 1000 hrs Recovery : At least 1hr of recovery under the standard removal from test chamber, followed by the measurement within 2hrs.
LHL□□□	: Temperature : $-40\pm 3^\circ\text{C}$ Duration : $1000\pm 24$ hrs Recovery : 1 to 2hrs of recovery under the standard condition after the removal from the test chamber.
FL	: Temperature : $-40\pm 3^\circ\text{C}$ Duration : 500 (+12, -0) hrs Recovery : 1 to 2hrs of recovery under the standard condition after the removal from the test chamber.
28. High temperature life test	
LA Type	
CAL45 Type	
LHL□□□	Appearance : No abnormality Inductance change : Within $\pm 10\%$ Q change : Within $\pm 30\%$ (LHLP : only $\Delta L/L$ )
FBA/FBR	
FL05□ Type	Refer to individual specification
FL06BT Type	Appearance : No abnormality Impedance change : Within $\pm 20\%$
[Test Method and Remarks]	
LHL□□□	: Temperature : $105\pm 3^\circ\text{C}$ Duration : $1000\pm 24$ hrs Recovery : 1 to 2hrs of recovery under the standard condition after the removal from the test chamber.
FL	: Temperature : $85\pm 3^\circ\text{C}$ Duration : 500 (+12, -0) hrs Recovery : 1 to 2hrs of recovery under the standard condition after the removal from the test chamber.

\* This catalog contains the typical specification only due to the limitation of space. When you consider purchase of our products, please check our specification.  
For details of each product (characteristics graph, reliability information, precautions for use, and so on), see our Web site (<http://www.ty-top.com/>) or CD catalogs.

## PRECAUTIONS

CAL Type, LH Type, FB Type, FL Type, LA Type

1. Circuit Design	
Precautions	<ul style="list-style-type: none"> <li>◆Operating environment</li> <li>1. The products described in this specification are intended for use in general electronic equipment, (office supply equipment, telecommunications systems, measuring equipment, and household equipment). They are not intended for use in mission-critical equipment or systems requiring special quality and high reliability (traffic systems, safety equipment, aerospace systems, nuclear control systems and medical equipment including life-support systems,) where product failure might result in loss of life, injury or damage. For such uses, contact TAIYO YUDEN Sales Department in advance.</li> </ul>
2. PCB Design	
Precautions	<ul style="list-style-type: none"> <li>◆Design</li> <li>1. Please design insertion pitches of a base in the pitches that fitted a terminal interval.</li> </ul>
Technical considerations	<ul style="list-style-type: none"> <li>◆Design</li> <li>1. When Inductors are mounted onto a PC board, hole dimensions on the board should match the lead pitch of the component, if not, it will cause breakage of the terminals or cracking of terminal roots covered with resin as excess stress travels through the terminal legs.</li> </ul>
3. Considerations for automatic placement	
Precautions	<ul style="list-style-type: none"> <li>◆Adjustment of mounting machine</li> <li>1. Excessive impact load should not be imposed on the products when mounting onto the PC boards.</li> <li>2. Mounting and soldering conditions should be checked beforehand.</li> </ul>
Technical considerations	<ul style="list-style-type: none"> <li>◆Adjustment of mounting machine</li> <li>1. When installing products, care should be taken not to apply distortion stress as it may deform the products.</li> </ul>
4. Soldering	
Precautions	<ul style="list-style-type: none"> <li>◆Wave soldering</li> <li>1. Please refer to the specifications in the catalog for a wave soldering.</li> <li>2. Do not immerse the entire Inductors in the flux during the soldering operation.</li> <li>◆Lead free soldering</li> <li>1. When using products with lead free soldering, we request to use them after confirming of adhesion, temperature of resistance to soldering heat, soldering etc sufficiently.</li> <li>Recommended conditions for using a soldering iron:                             <ul style="list-style-type: none"> <li>·Put the soldering iron on the land-pattern.</li> <li>·Soldering iron's temperature - Below 350°C</li> <li>·Duration - 3 seconds or less</li> <li>·The soldering iron should not directly touch the inductor.</li> </ul> </li> <li>◆Reflow soldering</li> <li>1. As for reflow soldering, please contact our sales staff.</li> </ul>
Technical considerations	<ul style="list-style-type: none"> <li>◆Lead free soldering</li> <li>1. If products are used beyond the range of the recommended conditions, heat stresses may deform the products, and consequently degrade the reliability of the products.</li> </ul>
5. Cleaning	
Precautions	<ul style="list-style-type: none"> <li>◆Cleaning conditions</li> <li>1. CAL type, LH type, LA Type</li> <li>Please do not do cleaning by a supersonic wave.</li> </ul>
Technical considerations	<ul style="list-style-type: none"> <li>◆Cleaning conditions</li> <li>1. CAL type, LH type, LA Type</li> <li>If washing by supersonic waves, supersonic waves may deform products.</li> </ul>
6. Handling	
Precautions	<ul style="list-style-type: none"> <li>◆Handling</li> <li>1. Keep the inductors away from all magnets and magnetic objects.</li> <li>◆Mechanical considerations</li> <li>1. Please do not give the inductors any excessive mechanical shocks.</li> <li>2. LH type</li> <li>If inductors are dropped onto the floor or a hard surface they should not be used.</li> <li>◆Packing</li> <li>1. Please do not give the inductors any excessive mechanical shocks.</li> <li>In loading, please pay attention to handling indication mentioned in a packing box (a loading direction / number of maximum loading / fragile item).</li> </ul>
Technical considerations	<ul style="list-style-type: none"> <li>◆Handling</li> <li>1. There is a case that a characteristic varies with magnetic influence.</li> <li>◆Mechanical considerations</li> <li>1. There is a case to be damaged by a mechanical shock.</li> <li>2. LH type</li> <li>There is a case to be broken by a fall.</li> <li>◆Packing</li> <li>1. There is a case that a lead route turns by a fall or an excessive shock.</li> </ul>
7. Storage conditions	
Precautions	<ul style="list-style-type: none"> <li>◆Storage</li> <li>1. To maintain the solderability of terminal electrodes and to keep the packing material in good condition, temperature and humidity in the storage area should be controlled.</li> <li>Recommended conditions                             <ul style="list-style-type: none"> <li>·Ambient temperature 0~40°C</li> <li>·Humidity Below 70% RH</li> </ul> </li> <li>The ambient temperature must be kept below 30°C. Even under ideal storage conditions, solderability of products electrodes may decrease as time passes. For this reason, inductors should be used within one year from the time of delivery.</li> <li>In case of storage over 6 months, solderability shall be checked before actual usage.</li> </ul>
Technical considerations	<ul style="list-style-type: none"> <li>◆Storage</li> <li>1. Under a high temperature and humidity environment, problems such as reduced solderability caused by oxidation of terminal electrodes and deterioration of taping/packaging materials may take place.</li> </ul>

\* This catalog contains the typical specification only due to the limitation of space. When you consider purchase of our products, please check our specification. For details of each product (characteristics graph, reliability information, precautions for use, and so on), see our Web site (<http://www.ty-top.com/>) or CD catalogs.