

# 有关敝公司产品的注意事项

请务必在使用敝公司产品之前阅读。



注意

## 产品目录中的记载内容

本产品目录中所记载的内容为2023年3月的内容。因产品改良等原因，可能会不经预告而变更其记载内容，或是停止供应本产品目录中所记载的产品。所以，请务必在使用前先确认最新的产品信息。

未按照本产品目录中所记载的内容或交货规格说明书使用敝公司产品的，即便其致使用设备发生损害、不良情况等时，敝公司也不承担任何责任，敬请知悉。

## 签署交货规格说明书

就本产品目录中所记载产品的产品规格等相关内容，敝公司备有交货规格说明书，详情请向敝公司咨询。在使用敝公司产品前请务必就交货规格说明书之内容确认并批准之。

## 实装前的事前评估

使用敝公司产品时，请务必事先安装到使用设备之后，在实际使用的环境下进行评估和确认。

## 用途的限定

### 1. 可以使用的设备

本产品目录中所记载的产品预设为使用于一般民用电子设备〔音像设备、办公自动化设备、家电产品、办公设备、信息通讯设备（手机、电脑等）〕以及面向本产品目录或是交货规格说明书中另行注明的设备或是敝公司另行承诺的设备的通用性，标准性用途。另外，面向下述设备的应用，敝公司也备有预设的产品系列，请参考本产品目录或是交货规格说明书的内容，使用相对应的产品。

用途	产品系列		品质等级 <sup>(注释3)</sup>
	对象设备 <sup>(注释1)</sup>	规格号 (型号标记 <sup>(注释2)</sup> )	
车载	汽车用电子设备（控制系 / 安全系）	A	1
	汽车用电子设备（车身系 / 情报系）	C	2
工业	通信基础设备·工业设备	B	2
医疗	医疗设备（国际（GHTF）第三类）	M	2
	医疗设备（国际（GHTF）第一类、第二类）	L	3
民用	一般电子设备	S	3
	移动设备专用 <sup>(注释4)</sup>	E	4

注释1：基于敝公司所认知的该类设备对于电子元器件所需的一般要求规格，对于该产品系列进行的应用推荐。在讨论将各个产品系列使用在对象设备以外的设备上时，请务必事先向敝公司咨询。

注释2：在产品型号中左起第2位标注有上表中所记载的“规格号”。对于相关的详细内容，请参照有关各产品型号标示法的说明资料。

注释3：在各产品系列中，都设定了从上至下1至4的“品质等级”。另外，在未得到敝公司的事前书面承诺之前，请勿将敝公司的产品使用于相对于该产品的品质等级被设定为上位品质等级的设备。

注释4：本产品系列仅可应用于一般民用电子设备中的移动设备（智能手机、平板电脑、智能手表、掌上游戏机等）。由于其设计、规格和使用环境与面向“一般电子设备”的产品系列（规格号：S）不同，有关本产品系列的详细信息请参照交货规格说明书。另外，面向“一般电子设备”的产品系列（规格号：S）也可以应用于移动设备。

## 2. 需要另行确认的设备

若考虑将本产品目录中所记载的产品使用于当产品发生故障、品质不良，或是由此引起的运转失常而可能会危及生命、身体或是财产，以及有可能给社会造成深刻影响的以下设备（不包括本产品目录或是交货规格说明书中另行注明可以使用设备）等时，请务必事先向敝公司咨询。

- (1) 运输用设备（汽车驱动控制设备、火车控制设备、船舶控制设备等）
- (2) 交通信号设备
- (3) 防灾 / 保安设备
- (4) 医疗设备（国际（GHTF）第三类）
- (5) 高公共性信息通讯设备 / 信息处理设备（电话交换机、电话 / 无线 / 广播电视基站等）
- (6) 其他与上述设备有同等品质与可靠性要求的设备

## 3. 禁止使用的设备

请勿将敝公司产品使用于对安全性和可靠性有着极高要求的以下设备。

- (1) 航天设备（人工卫星、火箭等）
- (2) 航空设备<sup>(注释1)</sup>
- (3) 医疗设备（国际（GHTF）第四类）、植体（体内植入型）医疗设备<sup>(注释2)</sup>
- (4) 发电控制设备（面向核能 / 水力 / 火力发电厂等的设备）
- (5) 海底设备（海底中继设备、海中的作业设备等）
- (6) 军事设备
- (7) 其他与上述设备有同等品质与可靠性要求的设备

注释1：仅限于对航空设备的安全运行不产生直接干扰的设备 [ 机内娱乐设备、机内照明设备、电动座椅、餐饮设备等 ]，在满足敝公司另行指定的相关条件时，亦可将敝公司产品用于以上用途。在贵公司考虑将敝公司的产品用于以上用途时，请务必事先向敝公司咨询相关的信息。

注释2：包括注入人体内的部分和与此相连接的体外部分。

## 4. 责任的限制

未经敝公司的事先书面同意，把本产品目录中所记载的产品使用于非敝公司预设用途的设备、前述需要向敝公司咨询的设备或敝公司禁止使用的设备，从而给客户或第三方造成损害的，敝公司不承担任何责任，敬请知悉。

### ■ 安全设计

需将敝公司的产品使用于对安全性和可靠性要求较高的设备、电路上时，请进行充分的安全性评估和可靠性评估。另外，请通过设置保护电路、保护装置的系统，设置冗余电路不会被单一故障影响安全性的系统等失效导向安全（fail-safe）设计，确保充分的安全性。

### ■ 有关知识产权

本产品目录中所记载的信息是用于说明相关产品的典型操作以及相关应用。此类信息的使用不代表对于敝公司以及第三方的知识产权以及其他权利的使用许可或是不侵权保证。

### ■ 保证范围

敝公司产品的保证范围仅限于符合交货规格说明书中所记载的产品规格且已经交付的敝公司产品本身，由敝公司产品的故障或不良情况所诱发的损害，敝公司不承担任何责任，敬请知悉。但是，仅限于敝公司的产品作为通用性，标准性用途使用于本产品目录或是交货规格说明书中另行注明的设备，且以书面形式另行签署了交易基本合同书，品质保证协定时，敝公司将根据该合同等的条件提供保证。

### ■ 正规销售渠道

本产品目录中所记载的内容适用于从敝公司营业所、销售子公司、销售代理店（即“正规销售渠道”）购买的敝公司产品，并不适用于从其他渠道购买的敝公司产品，敬请知悉。

### ■ 出口时的注意事项

本产品目录中所记载的部分产品在出口时须事先确认《外汇和对外贸易法》以及美国在出口管理方面的相关法规，并办理相关手续。如有不明之处，请向敝公司咨询。

▶ 由于篇幅有限，本产品目录中只记载了有代表性的产品规格，若考虑使用敝公司产品时，请确认交货规格说明书中的详细规格。另外，有关各产品的详细信息（特性图、可靠性信息、使用时的注意事项等），请参阅敝公司网站（<http://www.ty-top.com/>）。

# 通信基础设施 / 工业设备用途使用指引

敝公司对于在本产品目录中预设用途为“通信基础设施 / 工业设备用途（代表性产品如下表所列）”的设备，准备了与之相对应的产品系列（左起第二位的产品型号的记号为“B”）。因此，有意在此类设备采用敝公司产品时，请务必事先依照型号、交货规格说明书等内容，确认所欲使用之敝公司产品系列是属于此类面向通信基础设施 / 工业设备之产品后，再予采用。如有不明之处，请与敝公司取得联系。

产品系列 (左起第二位的产品型号的记号)	分类	通信基础设施 / 工业设备 (代表实例)
B	通信基础设施	<ul style="list-style-type: none"><li>• 基站电信装置</li><li>• 光收发器</li><li>• 路由器 / 交换器 (运营商级)</li><li>• UPS (不间断电源装置) 等</li></ul>
	自动化技术	<ul style="list-style-type: none"><li>• PLC (可程式化逻辑控制器)</li><li>• 伺服马达 / 伺服驱动器</li><li>• 工业用机器人 等</li></ul>
	测量仪器	<ul style="list-style-type: none"><li>• 燃气表</li><li>• 水表</li><li>• 流量计</li><li>• 压力传感器</li><li>• 磁力传感器</li><li>• 温度传感器 等</li></ul>
	电力设备	<ul style="list-style-type: none"><li>• 电力调整器 (太阳能发电系统)</li><li>• 智能电表 (电量测量仪)</li><li>• 漏电断路器</li><li>• EV充电桩 等</li></ul>

## 通信基础设备 / 工业设备用途 绕线型铁氧体系功率电感器 LBXN/LBXP 系列

系列前的记号来自型号，用来区分产品的种类和特性等。

回流焊

## ■ 型号标示法

\*使用温度范围：-40~125℃（包含产品本身发热）

L	B	X	N	D	4	0	4	0	T	K	L	1	0	0	M	D	G
①	②	③	④	⑤	⑥	⑦	⑧										

## ① 系列

代码 (1) (2) (3) (4)	
LBXN	通信基础设备 / 工业设备用途 绕线型铁氧体系功率电感器
LBXP	通信基础设备 / 工业设备用途 绕线型铁氧体系功率电感器

## (1) 产品群

代码	
L	电感器

## (2) 范畴

代码	推荐设备	品质等级
B	通信基础设备 / 工业设备	2

## ② 特征

代码	特征
D	底面电极（银×焊料）
E	底面电极（铜×焊料）
H	底面电极（框型）

## ③ 尺寸 (L×W)

代码	尺寸 (L×W) [mm]
2020	2.0×2.0
2424	2.4×2.4
3030	3.0×3.0
4040	4.0×4.0
5050	5.0×5.0
6060	6.0×6.0
8080	8.0×8.0

## ④ 尺寸 (H)

代码	尺寸 (H) [mm]
KK	1.0
MK	1.2
PK	1.4
QK	1.5
TK	1.8
WK	2.0
WD	2.4
WE	2.5
WH	2.8
XK	3.0
XA	3.1
YK	4.0
YA	4.1
YB	4.2
YE	4.5

## (3) 类型

代码	
X	绕线型铁氧体系 鼓型

## (4) 特效 / 特性

代码	
N	一般功率扼流
P	大电流功率扼流

## ⑤ 包装

代码	包装
T	卷盘带装
L	卷盘带装

## ⑥ 标称电感值

代码 (例)	标称电感值 [ $\mu$ H]
2R2	2.2
100	10
101	100

※R=小数点

## ⑦ 电感量公差

代码	电感量公差
M	±20%
N	±30%

## ⑧ 管理记号

▶ 由于篇幅有限，本产品目录中只记载了有代表性的产品规格，若考虑使用敝公司产品时，请确认交货规格说明书中的详细规格。  
另外，有关各产品的详细信息（特性图、可靠性信息、使用时的注意事项等），请参阅敝公司网站（<http://www.ty-top.com/>）。

## ■标准外型尺寸 / 标准数量

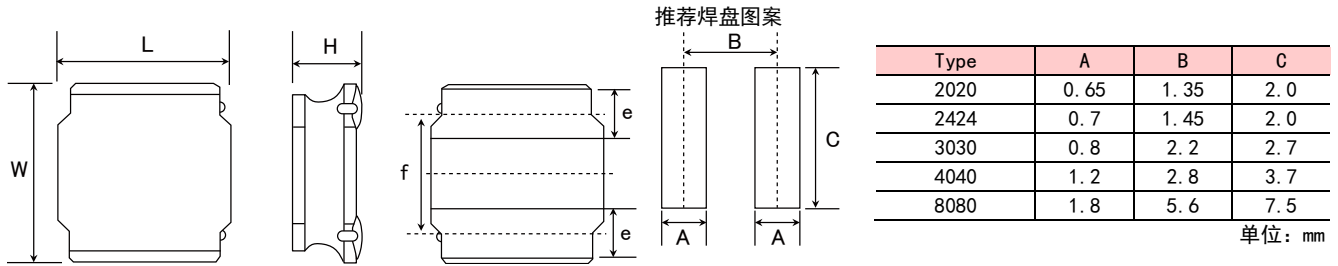

Type	L	W	H	e	f	标准数量 [pcs] 卷盘带装
2020KK	2.0±0.1 (0.079±0.004)	2.0±0.1 (0.079±0.004)	1.0 max (0.039 max)	0.5±0.2 (0.020±0.008)	1.25±0.2 (0.050±0.008)	2500
2020MK	2.0±0.1 (0.079±0.004)	2.0±0.1 (0.079±0.004)	1.2 max (0.047 max)	0.5±0.2 (0.020±0.008)	1.25±0.2 (0.050±0.008)	2500
2424KK	2.4±0.1 (0.095±0.004)	2.4±0.1 (0.095±0.004)	1.0 max (0.039 max)	0.6±0.2 (0.024±0.008)	1.45±0.2 (0.057±0.008)	2500
2424MK	2.4±0.1 (0.095±0.004)	2.4±0.1 (0.095±0.004)	1.2 max (0.047 max)	0.6±0.2 (0.024±0.008)	1.45±0.2 (0.057±0.008)	2500
3030KK	3.0±0.1 (0.118±0.004)	3.0±0.1 (0.118±0.004)	1.0 max (0.039 max)	0.9±0.2 (0.035±0.008)	1.9±0.2 (0.075±0.008)	2000
3030MK	3.0±0.1 (0.118±0.004)	3.0±0.1 (0.118±0.004)	1.2 max (0.047 max)	0.9±0.2 (0.035±0.008)	1.9±0.2 (0.075±0.008)	2000
3030QK	3.0±0.1 (0.118±0.004)	3.0±0.1 (0.118±0.004)	1.5 max (0.059 max)	0.9±0.2 (0.035±0.008)	1.9±0.2 (0.075±0.008)	2000
4040KK	4.0±0.2 (0.158±0.008)	4.0±0.2 (0.158±0.008)	1.0 max (0.039 max)	1.1±0.2 (0.043±0.008)	2.5±0.2 (0.098±0.008)	5000
4040MK	4.0±0.2 (0.158±0.008)	4.0±0.2 (0.158±0.008)	1.2 max (0.047 max)	1.1±0.2 (0.043±0.008)	2.5±0.2 (0.098±0.008)	4500
4040TK	4.0±0.2 (0.158±0.008)	4.0±0.2 (0.158±0.008)	1.8 max (0.071 max)	1.1±0.2 (0.043±0.008)	2.5±0.2 (0.098±0.008)	3500
8080XK	8.0±0.2 (0.315±0.008)	8.0±0.2 (0.315±0.008)	3.0 max (0.118 max)	1.60±0.3 (0.063±0.012)	5.6±0.3 (0.22±0.012)	1000
8080YK	8.0±0.2 (0.315±0.008)	8.0±0.2 (0.315±0.008)	4.0 max (0.158 max)	1.60±0.3 (0.063±0.012)	5.6±0.3 (0.22±0.012)	1000
8040YB	8.0±0.2 (0.315±0.008)	8.0±0.2 (0.315±0.008)	4.2 max (0.165 max)	1.60±0.3 (0.063±0.012)	5.6±0.3 (0.22±0.012)	1000

单位: mm (inch)

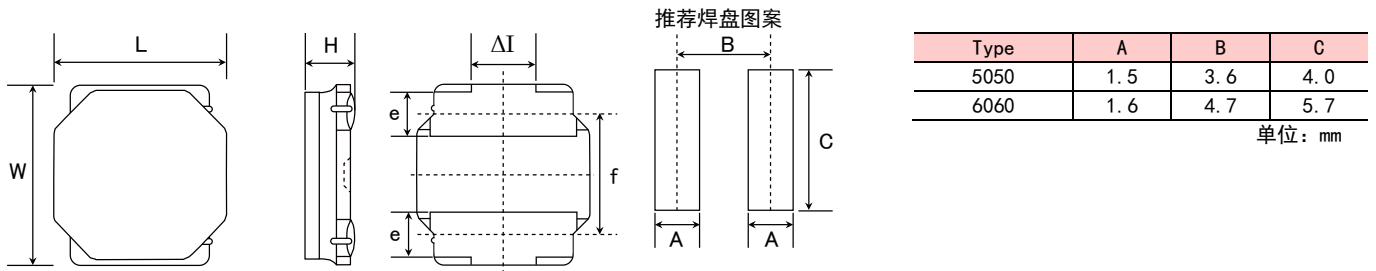

Type	L	W	H	e	f	$\Delta l$	标准数量[pcs] 卷盘带装
5050KK	4.9±0.2 (0.193±0.008)	4.9±0.2 (0.193±0.008)	1.0 max (0.039 max)	1.2±0.2 (0.047±0.008)	3.3±0.2 (0.130±0.008)	1.3typ (0.051typ)	1000
5050MK	4.9±0.2 (0.193±0.008)	4.9±0.2 (0.193±0.008)	1.2 max (0.047 max)	1.2±0.2 (0.047±0.008)	3.3±0.2 (0.130±0.008)	1.3typ (0.051typ)	1000
5050PK	4.9±0.2 (0.193±0.008)	4.9±0.2 (0.193±0.008)	1.4 max (0.055 max)	1.2±0.2 (0.047±0.008)	3.3±0.2 (0.130±0.008)	1.3typ (0.051typ)	1000
5050WK	4.9±0.2 (0.193±0.008)	4.9±0.2 (0.193±0.008)	2.0 max (0.079 max)	1.2±0.2 (0.047±0.008)	3.3±0.2 (0.130±0.008)	1.3typ (0.051typ)	800
5050WD	4.9±0.2 (0.193±0.008)	4.9±0.2 (0.193±0.008)	2.4max (0.095 max)	1.2±0.2 (0.047±0.008)	3.3±0.2 (0.130±0.008)	1.3typ (0.051typ)	2500
5050WE	4.9±0.2 (0.193±0.008)	4.9±0.2 (0.193±0.008)	2.5 max (0.098 max)	1.2±0.2 (0.047±0.008)	3.3±0.2 (0.130±0.008)	1.3typ (0.051typ)	2500
5050XK	4.9±0.2 (0.193±0.008)	4.9±0.2 (0.193±0.008)	3.0 max (0.118 max)	1.2±0.2 (0.047±0.008)	3.3±0.2 (0.130±0.008)	1.3typ (0.051typ)	500
5050XA	4.9±0.2 (0.193±0.008)	4.9±0.2 (0.193±0.008)	3.1 max (0.122 max)	1.2±0.2 (0.047±0.008)	3.3±0.2 (0.130±0.008)	1.3typ (0.051typ)	500
5050YK	4.9±0.2 (0.193±0.008)	4.9±0.2 (0.193±0.008)	4.0 max (0.158 max)	1.2±0.2 (0.047±0.008)	3.3±0.2 (0.130±0.008)	1.3typ (0.051typ)	1500
5050YA	4.9±0.2 (0.193±0.008)	4.9±0.2 (0.193±0.008)	4.1 max (0.161 max)	1.2±0.2 (0.047±0.008)	3.3±0.2 (0.130±0.008)	1.3typ (0.051typ)	1500
6060KK	6.0±0.2 (0.236±0.008)	6.0±0.2 (0.236±0.008)	1.0 max (0.039 max)	1.35±0.2 (0.053±0.008)	4.0±0.2 (0.158±0.008)	2.3typ (0.091typ)	1000
6060MK	6.0±0.2 (0.236±0.008)	6.0±0.2 (0.236±0.008)	1.2 max (0.047 max)	1.35±0.2 (0.053±0.008)	4.0±0.2 (0.158±0.008)	2.3typ (0.091typ)	1000
6060PK	6.0±0.2 (0.236±0.008)	6.0±0.2 (0.236±0.008)	1.4 max (0.055 max)	1.35±0.2 (0.053±0.008)	4.0±0.2 (0.158±0.008)	2.3typ (0.091typ)	1000
6060WK	6.0±0.2 (0.236±0.008)	6.0±0.2 (0.236±0.008)	2.0 max (0.079 max)	1.35±0.2 (0.053±0.008)	4.0±0.2 (0.158±0.008)	2.3typ (0.091typ)	2500
6060WH	6.0±0.2 (0.236±0.008)	6.0±0.2 (0.236±0.008)	2.8 max (0.110 max)	1.35±0.2 (0.053±0.008)	4.0±0.2 (0.158±0.008)	2.3typ (0.091typ)	2000
6060YE	6.0±0.2 (0.236±0.008)	6.0±0.2 (0.236±0.008)	4.5 max (0.177 max)	1.35±0.2 (0.053±0.008)	4.0±0.2 (0.158±0.008)	2.3typ (0.091typ)	1500

单位: mm (inch)

■ PART NUMBER

• All the Wire-wound Ferrite Power Inductors of the catalog lineup are RoHS compliant.

Notes)  
 • The exchange of individual specifications is necessary depending on your application and/or circuit condition. Please contact TAIYO YUDEN's official sales channel.  
 • The products are for Telecommunications infrastructure and Industrial equipment.  
 Please consult with TAIYO YUDEN's official sales channel for the details of the product specifications, etc., and please review and approve the product specifications before ordering.

● 2020KK type

New part number	Old part number (for reference)	Nominal inductance [ $\mu$ H]	Inductance tolerance	Self-resonant frequency [MHz] (min.)	DC Resistance [ $\Omega$ ] ( $\pm 20\%$ )	Rated current ※) [mA]		Measuring frequency [kHz]
						Saturation current Idc1	Temperature rise current Idc2	
LBXPD2020KKT47N0G	NRV2010T R47N GF8	0.47	$\pm 30\%$	-	0.052	2,100	2,000	100
LBXPD2020KKT68N0G	NRV2010T R68N GF8	0.68	$\pm 30\%$	-	0.060	1,850	1,850	100
LBXPD2020KKT1R0N0G	NRV2010T 1R0N GF8	1.0	$\pm 30\%$	-	0.080	1,550	1,600	100
LBXPD2020KKT1R5M0G	NRV2010T 1R5M GF8	1.5	$\pm 20\%$	-	0.100	1,350	1,450	100
LBXPD2020KKT2R2M0G	NRV2010T 2R2M GF8	2.2	$\pm 20\%$	-	0.175	1,100	1,100	100
LBXPD2020KKT3R3M0G	NRV2010T 3R3M GF8	3.3	$\pm 20\%$	-	0.250	880	1,000	100
LBXPD2020KKT4R7M0G	NRV2010T 4R7M GF8	4.7	$\pm 20\%$	-	0.320	760	820	100

● 2020MK type

New part number	Old part number (for reference)	Nominal inductance [ $\mu$ H]	Inductance tolerance	Self-resonant frequency [MHz] (min.)	DC Resistance [ $\Omega$ ] ( $\pm 20\%$ )	Rated current ※) [mA]		Measuring frequency [kHz]
						Saturation current Idc1	Temperature rise current Idc2	
LBXPD2020MKT1R0N0G	NRV2012T 1R0N GF8	1.0	$\pm 30\%$	-	0.073	2,200	1,650	100
LBXPD2020MKT1R5N0G	NRV2012T 1R5N GF8	1.5	$\pm 30\%$	-	0.100	1,800	1,400	100
LBXPD2020MKT2R2M0G	NRV2012T 2R2M GF8	2.2	$\pm 20\%$	-	0.129	1,600	1,200	100
LBXPD2020MKT3R3M0G	NRV2012T 3R3M GF8	3.3	$\pm 20\%$	-	0.227	1,250	900	100
LBXPD2020MKT4R7M0G	NRV2012T 4R7M GF8	4.7	$\pm 20\%$	-	0.325	1,100	750	100

● 2020MK type

New part number	Old part number (for reference)	Nominal inductance [ $\mu$ H]	Inductance tolerance	Self-resonant frequency [MHz] (min.)	DC Resistance [ $\Omega$ ] ( $\pm 20\%$ )	Rated current ※) [mA]		Measuring frequency [kHz]
						Saturation current Idc1	Temperature rise current Idc2	
LBXND2020MKT1R0N0G	NRS2012T 1R0N GJ8	1.0	$\pm 30\%$	-	0.070	1,900	1,700	100
LBXND2020MKT1R5N0G	NRS2012T 1R5N GJ8	1.5	$\pm 30\%$	-	0.090	1,650	1,500	100
LBXND2020MKT2R2M0G	NRS2012T 2R2M GJ8	2.2	$\pm 20\%$	-	0.107	1,350	1,370	100
LBXND2020MKT3R3M0G	NRS2012T 3R3M GJ8	3.3	$\pm 20\%$	-	0.190	1,000	1,020	100
LBXND2020MKT4R7M0G	NRS2012T 4R7M GJ8	4.7	$\pm 20\%$	-	0.241	900	910	100

● 2424KK type

New part number	Old part number (for reference)	Nominal inductance [ $\mu$ H]	Inductance tolerance	Self-resonant frequency [MHz] (min.)	DC Resistance [ $\Omega$ ] ( $\pm 20\%$ )	Rated current ※) [mA]		Measuring frequency [kHz]
						Saturation current Idc1	Temperature rise current Idc2	
LBXNE2424KKT68NN	NRH2410T R68NN 48	0.68	$\pm 30\%$	120	0.060	2,200	1,570	100
LBXNE2424KKT1R0NN	NRH2410T 1R0NN 48	1.0	$\pm 30\%$	106	0.070	1,800	1,410	100
LBXNE2424KKT1R5MN	NRH2410T 1R5MN 8	1.5	$\pm 20\%$	94	0.110	1,550	1,160	100
LBXNE2424KKT2R2MN	NRH2410T 2R2MN 8	2.2	$\pm 20\%$	77	0.150	1,290	970	100
LBXNE2424KKT3R3MN	NRH2410T 3R3MN 8	3.3	$\pm 20\%$	56	0.220	1,000	770	100
LBXNE2424KKT4R7MN	NRH2410T 4R7MN 8	4.7	$\pm 20\%$	50	0.290	880	670	100
LBXNE2424KKT6R8MN	NRH2410T 6R8MN 8	6.8	$\pm 20\%$	43	0.410	750	570	100
LBXNE2424KKT100MN	NRH2410T 100MN 8	10	$\pm 20\%$	32	0.690	550	450	100
LBXNE2424KKT150MN	NRH2410T 150MN 8	15	$\pm 20\%$	27	1.02	470	370	100
LBXNE2424KKT220MN	NRH2410T 220MN 8	22	$\pm 20\%$	22	1.47	390	300	100

● 2424MK type

New part number	Old part number (for reference)	Nominal inductance [ $\mu$ H]	Inductance tolerance	Self-resonant frequency [MHz] (min.)	DC Resistance [ $\Omega$ ] ( $\pm 20\%$ )	Rated current ※) [mA]		Measuring frequency [kHz]
						Saturation current Idc1	Temperature rise current Idc2	
LBXNE2424MKT47NNG	NRH2412T R47NNGJ8	0.47	$\pm 30\%$	180	0.050	2,900	2,100	100
LBXNE2424MKT1R0NNG	NRH2412T 1R0NNGH8	1.0	$\pm 30\%$	101	0.077	2,350	1,300	100
LBXNE2424MKT1R5NNG	NRH2412T 1R5NNGH8	1.5	$\pm 30\%$	89	0.100	2,100	1,150	100
LBXNE2424MKT2R2MNG	NRH2412T 2R2MNGH8	2.2	$\pm 20\%$	72	0.140	1,700	1,000	100
LBXNE2424MKT3R3MNG	NRH2412T 3R3MNGH8	3.3	$\pm 20\%$	56	0.225	1,400	750	100
LBXNE2424MKT4R7MNG	NRH2412T 4R7MNGH8	4.7	$\pm 20\%$	45	0.300	1,150	650	100
LBXNE2424MKT6R8MNG	NRH2412T 6R8MNGH8	6.8	$\pm 20\%$	34	0.420	950	550	100
LBXNE2424MKT100MNG	NRH2412T 100MNGH8	10	$\pm 20\%$	29	0.600	810	450	100

※) The saturation current value (Idc1) is the DC current value having inductance decrease down to 30%. (at 20°C)  
 ※) The temperature rise current value (Idc2) is the DC current value having temperature increase up to 40°C. (at 20°C)  
 ※) The rated current is the DC current value that satisfies both of current value saturation current value and temperature rise current value.

▶ This catalog contains the typical specification only due to the limitation of space. When you consider the purchase of our products, please check our specification. For details of each product (characteristics graph, reliability information, precautions for use, and so on), see our Web site (<http://www.ty-top.com/>).



■ PART NUMBER

● 3030KK type

New part number	Old part number (for reference)	Nominal inductance [μH]	Inductance tolerance	Self-resonant frequency [MHz] (min.)	DC Resistance [Ω] (±20%)	Rated current ※) [mA]		Measuring frequency [kHz]
						Saturation current Idc1	Temperature rise current Idc2	
LBXNE3030KKT1R2NN	NRH3010T 1R2NN 8	1.2	±30%	120	0.065	1,700	1,480	100
LBXNE3030KKT1R5NN	NRH3010T 1R5NN 8	1.5	±30%	99	0.075	1,440	1,370	100
LBXNE3030KKT2R2MN	NRH3010T 2R2MN 8	2.2	±20%	86	0.083	1,300	1,300	100
LBXNE3030KKT3R3MN	NRH3010T 3R3MN 8	3.3	±20%	64	0.130	1,000	1,030	100
LBXNE3030KKT4R7MN	NRH3010T 4R7MN 8	4.7	±20%	50	0.170	850	900	100
LBXNE3030KKT6R8MN	NRH3010T 6R8MN 8	6.8	±20%	44	0.250	700	745	100
LBXNE3030KKT100MN	NRH3010T 100MN 8	10	±20%	34	0.350	600	620	100
LBXNE3030KKT150MN	NRH3010T 150MN 8	15	±20%	25	0.550	450	480	100
LBXNE3030KKT220MN	NRH3010T 220MN 8	22	±20%	22	0.770	380	410	100
LBXNE3030KKT470MN	NRH3010T 470MN 8	47	±20%	17	2.05	250	285	100

● 3030MK type

New part number	Old part number (for reference)	Nominal inductance [μH]	Inductance tolerance	Self-resonant frequency [MHz] (min.)	DC Resistance [Ω] (±20%)	Rated current ※) [mA]		Measuring frequency [kHz]
						Saturation current Idc1	Temperature rise current Idc2	
LBXNE3030MKTR47NN	NRH3012T 4R7NN 8	0.47	±30%	160	0.033	2,600	1,900	100
LBXNE3030MKTR1R0NN	NRH3012T 1R0NN 8	1.0	±30%	111	0.048	2,200	1,710	100
LBXNE3030MKTR1R5NN	NRH3012T 1R5NN 8	1.5	±30%	95	0.055	1,700	1,600	100
LBXNE3030MKTR2R2MN	NRH3012T 2R2MN 8	2.2	±20%	78	0.075	1,500	1,370	100
LBXNE3030MKTR3R3MN	NRH3012T 3R3MN 8	3.3	±20%	61	0.100	1,200	1,210	100
LBXNE3030MKTR4R7MN	NRH3012T 4R7MN 8	4.7	±20%	50	0.130	1,000	1,060	100
LBXNE3030MKTR6R8MN	NRH3012T 6R8MN 8	6.8	±20%	43	0.190	850	890	100
LBXNE3030MKTR100MN	NRH3012T 100MN 8	10	±20%	32	0.270	730	720	100
LBXNE3030MKTR150MN	NRH3012T 150MN 8	15	±20%	26	0.450	530	570	100
LBXNE3030MKTR220MN	NRH3012T 220MN 8	22	±20%	22	0.630	500	500	100

● 3030MK type

New part number	Old part number (for reference)	Nominal inductance [μH]	Inductance tolerance	Self-resonant frequency [MHz] (min.)	DC Resistance [Ω] (±20%)	Rated current ※) [mA]		Measuring frequency [kHz]
						Saturation current Idc1	Temperature rise current Idc2	
LBXPD3030MKT1R0N	NRV3012T 1R0N 8	1.0	±30%	110	0.065	2,500	1,600	100
LBXPD3030MKT1R5N	NRV3012T 1R5N 8	1.5	±30%	92	0.075	2,100	1,400	100
LBXPD3030MKT2R2M	NRV3012T 2R2M 8	2.2	±20%	70	0.120	1,800	1,100	100
LBXPD3030MKT3R3M	NRV3012T 3R3M 8	3.3	±20%	55	0.150	1,600	1,000	100
LBXPD3030MKT4R7M	NRV3012T 4R7M 8	4.7	±20%	48	0.190	1,250	850	100
LBXPD3030MKT6R8M	NRV3012T 6R8M 8	6.8	±20%	40	0.300	950	650	100
LBXPD3030MKT100M	NRV3012T 100M 8	10	±20%	32	0.470	800	550	100

● 3030QK type

New part number	Old part number (for reference)	Nominal inductance [μH]	Inductance tolerance	Self-resonant frequency [MHz] (min.)	DC Resistance [Ω] (±20%)	Rated current ※) [mA]		Measuring frequency [kHz]
						Saturation current Idc1	Temperature rise current Idc2	
LBXND3030QKT1R0NNG	NRS3015T 1R0NNGH8	1.0	±30%	100	0.030	2,100	2,100	100
LBXND3030QKT1R5NNG	NRS3015T 1R5NNGH8	1.5	±30%	87	0.038	1,800	1,820	100
LBXND3030QKT2R2MNG	NRS3015T 2R2MNGH8	2.2	±20%	64	0.058	1,480	1,500	100
LBXND3030QKT3R3MNG	NRS3015T 3R3MNGH8	3.3	±20%	49	0.078	1,210	1,230	100
LBXND3030QKT4R7MNG	NRS3015T 4R7MNGH8	4.7	±20%	40	0.120	1,020	1,040	100
LBXND3030QKT6R8MNG	NRS3015T 6R8MNGH8	6.8	±20%	36	0.160	870	880	100
LBXND3030QKT100MNG	NRS3015T 100MNGH8	10	±20%	28	0.220	700	710	100
LBXND3030QKT220MNG	NRS3015T 220MNGH8	22	±20%	20	0.520	470	470	100
LBXND3030QKT330MNG	NRS3015T 330MNGH8	33	±20%	18	0.780	400	440	100

● 4040KK type

New part number	Old part number (for reference)	Nominal inductance [μH]	Inductance tolerance	Self-resonant frequency [MHz] (min.)	DC Resistance [Ω] (±20%)	Rated current ※) [mA]		Measuring frequency [kHz]
						Saturation current Idc1	Temperature rise current Idc2	
LBXND4040KKL1R0NDG	NRS4010T 1R0NDGG8	1.0	±30%	116	0.056	2,000	1,900	100
LBXND4040KKL2R2MDG	NRS4010T 2R2MDGG8	2.2	±20%	73	0.085	1,200	1,500	100
LBXND4040KKL3R3MDG	NRS4010T 3R3MDGG8	3.3	±20%	58	0.100	1,100	1,400	100
LBXND4040KKL4R7MDG	NRS4010T 4R7MDGG8	4.7	±20%	47	0.140	950	1,200	100
LBXND4040KKL6R8MDG	NRS4010T 6R8MDGG8	6.8	±20%	38	0.200	800	1,000	100
LBXND4040KKL100MDG	NRS4010T 100MDGG8	10	±20%	31	0.300	620	750	100
LBXND4040KKL150MDG	NRS4010T 150MDGG8	15	±20%	24	0.430	540	600	100
LBXND4040KKL220MDG	NRS4010T 220MDGG8	22	±20%	19	0.570	450	500	100

● 4040MK type

New part number	Old part number (for reference)	Nominal inductance [μH]	Inductance tolerance	Self-resonant frequency [MHz] (min.)	DC Resistance [Ω] (±20%)	Rated current ※) [mA]		Measuring frequency [kHz]
						Saturation current Idc1	Temperature rise current Idc2	
LBXND4040MKL1R0NDG	NRS4012T 1R0NDGG8	1.0	±30%	100	0.042	2,800	2,200	100
LBXND4040MKL2R2MDG	NRS4012T 2R2MDGJ8	2.2	±20%	70	0.060	1,650	1,900	100
LBXND4040MKL3R3MDG	NRS4012T 3R3MDGJ8	3.3	±20%	60	0.070	1,400	1,700	100
LBXND4040MKL4R7MDG	NRS4012T 4R7MDGJ8	4.7	±20%	45	0.095	1,200	1,500	100
LBXND4040MKL6R8MDG	NRS4012T 6R8MDGJ8	6.8	±20%	35	0.125	900	1,300	100
LBXND4040MKL100MDG	NRS4012T 100MDGJ8	10	±20%	30	0.170	800	1,100	100
LBXND4040MKL150MDG	NRS4012T 150MDGJ8	15	±20%	24	0.260	650	750	100
LBXND4040MKL220MDG	NRS4012T 220MDGJ8	22	±20%	18	0.400	500	620	100

※) The saturation current 8alue (Idc1) is the DC current 8alue ha8ing inductance decrease down to 30%. (at 20°C)

※) The temperature rise current 8alue (Idc2) is the DC current 8alue ha8ing temperature increase up to 40°C. (at 20°C)

※) The rated current is the DC current 8alue that satisfies both of current 8alue saturation current 8alue and temperature rise current 8alue.

▶ This catalog contains the typical specification only due to the limitation of space. When you consider the purchase of our products, please check our specification.  
For details of each product (characteristics graph, reliability information, precautions for use, and so on), see our Web site (<http://www.ty-top.com/>).



■ PART NUMBER

● 4040TK type

New part number	Old part number (for reference)	Nominal inductance [ $\mu$ H]	Inductance tolerance	Self-resonant frequency [MHz] (min.)	DC Resistance [ $\Omega$ ] ( $\pm 20\%$ )	Rated current ※) [mA]		Measuring frequency [kHz]
						Saturation current Idc1	Temperature rise current Idc2	
LBXND4040TKL1R0NDG	NRS4018T 1R0NDGJ8	1.0	$\pm 30\%$	90	0.027	4,000	3,200	100
LBXND4040TKL1R5NDG	NRS4018T 1R5NDGJ8	1.5	$\pm 30\%$	75	0.037	3,300	2,400	100
LBXND4040TKL2R2MDG	NRS4018T 2R2MDGJ8	2.2	$\pm 20\%$	60	0.042	3,000	2,200	100
LBXND4040TKL3R3MDG	NRS4018T 3R3MDGJ8	3.3	$\pm 20\%$	45	0.055	2,300	2,000	100
LBXND4040TKL4R7MDG	NRS4018T 4R7MDGJ8	4.7	$\pm 20\%$	35	0.070	2,000	1,700	100
LBXND4040TKL6R8MDG	NRS4018T 6R8MDGJ8	6.8	$\pm 20\%$	30	0.098	1,600	1,450	100
LBXND4040TKL100MDG	NRS4018T 100MDGJ8	10	$\pm 20\%$	25	0.150	1,300	1,200	100
LBXND4040TKL150MDG	NRS4018T 150MDGJ8	15	$\pm 20\%$	18	0.210	1,100	850	100
LBXND4040TKL220MDG	NRS4018T 220MDGJ8	22	$\pm 20\%$	15	0.290	900	720	100
LBXND4040TKL330MDG	NRS4018T 330MDGJ8	33	$\pm 20\%$	12	0.460	700	550	100
LBXND4040TKL470MDG	NRS4018T 470MDGJ8	47	$\pm 20\%$	10	0.650	600	440	100
LBXND4040TKL680MDG	NRS4018T 680MDGJ8	68	$\pm 20\%$	8.3	1.00	520	320	100
LBXND4040TKL101MDG	NRS4018T 101MDGJ8	100	$\pm 20\%$	6.5	1.45	420	280	100
LBXND4040TKL151MDG	NRS4018T 151MDGJ8	150	$\pm 20\%$	5.5	2.30	340	220	100
LBXND4040TKL221MDG	NRS4018T 221MDGJ8	220	$\pm 20\%$	4.0	3.80	275	170	100

● 5050KK type

New part number	Old part number (for reference)	Nominal inductance [ $\mu$ H]	Inductance tolerance	Self-resonant frequency [MHz] (min.)	DC Resistance [ $\Omega$ ] ( $\pm 20\%$ )	Rated current ※) [mA]		Measuring frequency [kHz]
						Saturation current Idc1	Temperature rise current Idc2	
LBXND5050KKT1R0NMG	NRS5010T 1R0NMGF8	1.0	$\pm 30\%$	95	0.070	2,350	1,750	100
LBXND5050KKT2R2NMG	NRS5010T 2R2NMGF8	2.2	$\pm 30\%$	65	0.105	1,500	1,400	100
LBXND5050KKT3R3MMG	NRS5010T 3R3MMGF8	3.3	$\pm 20\%$	42	0.125	1,400	1,250	100
LBXND5050KKT4R7MMG	NRS5010T 4R7MMGF8	4.7	$\pm 20\%$	37	0.145	1,200	1,150	100
LBXND5050KKT6R8MMG	NRS5010T 6R8MMGF8	6.8	$\pm 20\%$	33	0.185	1,000	1,000	100
LBXND5050KKT100MMG	NRS5010T 100MMGF8	10	$\pm 20\%$	23	0.250	850	900	100
LBXND5050KKT150MMG	NRS5010T 150MMGF8	15	$\pm 20\%$	19	0.400	680	650	100
LBXND5050KKT220MMG	NRS5010T 220MMGF8	22	$\pm 20\%$	15	0.600	550	450	100

● 5050MK type

New part number	Old part number (for reference)	Nominal inductance [ $\mu$ H]	Inductance tolerance	Self-resonant frequency [MHz] (min.)	DC Resistance [ $\Omega$ ] ( $\pm 20\%$ )	Rated current ※) [mA]		Measuring frequency [kHz]
						Saturation current Idc1	Temperature rise current Idc2	
LBXND5050MKT1R0NMG	NRS5012T 1R0NMGF8	1.0	$\pm 30\%$	100	0.053	4,500	2,300	100
LBXND5050MKT1R5NMG	NRS5012T 1R5NMGF8	1.5	$\pm 30\%$	86	0.070	3,800	2,200	100
LBXND5050MKT2R2MMG	NRS5012T 2R2MMGF8	2.2	$\pm 20\%$	70	0.085	3,100	2,000	100
LBXND5050MKT3R3MMG	NRS5012T 3R3MMGF8	3.3	$\pm 20\%$	48	0.160	2,400	1,450	100
LBXND5050MKT4R7MMG	NRS5012T 4R7MMGF8	4.7	$\pm 20\%$	40	0.180	2,200	1,400	100
LBXND5050MKT6R8MMG	NRS5012T 6R8MMGF8	6.8	$\pm 20\%$	36	0.260	1,700	1,100	100
LBXND5050MKT100MMG	NRS5012T 100MMGF8	10	$\pm 20\%$	26	0.420	1,400	850	100
LBXND5050MKT150MMG	NRS5012T 150MMGF8	15	$\pm 20\%$	22	0.670	1,200	640	100

● 5050PK type

New part number	Old part number (for reference)	Nominal inductance [ $\mu$ H]	Inductance tolerance	Self-resonant frequency [MHz] (min.)	DC Resistance [ $\Omega$ ] ( $\pm 20\%$ )	Rated current ※) [mA]		Measuring frequency [kHz]
						Saturation current Idc1	Temperature rise current Idc2	
LBXND5050PKTR47NMG	NRS5014T R47NMGG8	0.47	$\pm 30\%$	185	0.025	5,800	3,300	100
LBXND5050PKT1R2NMG	NRS5014T 1R2NMGG8	1.2	$\pm 30\%$	86	0.045	3,800	2,400	100
LBXND5050PKT2R2NMG	NRS5014T 2R2NMGG8	2.2	$\pm 30\%$	56	0.065	2,800	2,000	100
LBXND5050PKT3R3NMG	NRS5014T 3R3NMGG8	3.3	$\pm 30\%$	48	0.080	2,350	1,700	100
LBXND5050PKT4R7NMG	NRS5014T 4R7NMGG8	4.7	$\pm 30\%$	41	0.100	2,050	1,400	100
LBXND5050PKT6R8MMG	NRS5014T 6R8MMGG8	6.8	$\pm 20\%$	33	0.150	1,600	1,200	100
LBXND5050PKT100MMG	NRS5014T 100MMGG8	10	$\pm 20\%$	27	0.200	1,400	1,050	100
LBXND5050PKT150MMG	NRS5014T 150MMGG8	15	$\pm 20\%$	20	0.320	1,100	650	100
LBXND5050PKT220MMG	NRS5014T 220MMGG8	22	$\pm 20\%$	16	0.450	900	550	100

● 5050WK type

New part number	Old part number (for reference)	Nominal inductance [ $\mu$ H]	Inductance tolerance	Self-resonant frequency [MHz] (min.)	DC Resistance [ $\Omega$ ] ( $\pm 20\%$ )	Rated current ※) [mA]		Measuring frequency [kHz]
						Saturation current Idc1	Temperature rise current Idc2	
LBXND5050WKT R47NMG	NRS5020T R47NMGJ8	0.47	$\pm 30\%$	230	0.012	6,100	5,000	100
LBXND5050WKT1R0NMG	NRS5020T 1R0NMGJ8	1.0	$\pm 30\%$	81	0.021	4,000	3,600	100
LBXND5050WKT1R5NMG	NRS5020T 1R5NMGJ8	1.5	$\pm 30\%$	68	0.026	3,350	3,200	100
LBXND5050WKT2R2NMG	NRS5020T 2R2NMGJ8	2.2	$\pm 30\%$	57	0.035	2,900	2,900	100
LBXND5050WKT3R3NMG	NRS5020T 3R3NMGJ8	3.3	$\pm 30\%$	46	0.048	2,400	2,400	100
LBXND5050WKT4R7MMG	NRS5020T 4R7MMGJ8	4.7	$\pm 20\%$	37	0.060	2,000	2,000	100
LBXND5050WKT6R8MMG	NRS5020T 6R8MMGJ8	6.8	$\pm 20\%$	30	0.090	1,600	1,650	100
LBXND5050WKT100MMG	NRS5020T 100MMGJ8	10	$\pm 20\%$	24	0.120	1,300	1,450	100
LBXND5050WKT150MMG	NRS5020T 150MMGJ8	15	$\pm 20\%$	20	0.165	1,100	1,200	100
LBXND5050WKT220MMG	NRS5020T 220MMGJ8	22	$\pm 20\%$	17	0.260	900	1,000	100
LBXND5050WKT470MMG	NRS5020T 470MMGJ8	47	$\pm 20\%$	12	0.435	630	560	100
LBXND5050WKT101MMG	NRS5020T 101MMGJ8	100	$\pm 20\%$	7	0.850	420	400	100

※) The saturation current 8alue (Idc1) is the DC current 8alue ha8ing inductance decrease down to 30%. (at 20°C)

※) The temperature rise current 8alue (Idc2) is the DC current 8alue ha8ing temperature increase up to 40°C. (at 20°C)

※) The rated current is the DC current 8alue that satisfies both of current 8alue saturation current 8alue and temperature rise current 8alue.

▶ This catalog contains the typical specification only due to the limitation of space. When you consider the purchase of our products, please check our specification.  
For details of each product (characteristics graph, reliability information, precautions for use, and so on), see our Web site (<http://www.ty-top.com/>).

■ PART NUMBER

● 5050WE/5050WD type

New part number	Old part number (for reference)	Nominal inductance [μH]	Inductance tolerance	Self-resonant frequency [MHz] (min.)	DC Resistance [Ω] (±20%)	Rated current ※) [mA]		Measuring frequency [kHz]
						Saturation current Idc1	Temperature rise current Idc2	
LBXND5050WEL1R0NMG	NRS5024T 1R0NMGJ8	1.0	±30%	85	0.016	5,800	4,400	100
LBXND5050WEL1R5NMG	NRS5024T 1R5NMGJ8	1.5	±30%	67	0.022	5,200	3,600	100
LBXND5050WDL2R2NMG	NRS5024T 2R2NMGJ8	2.2	±30%	51	0.029	4,100	3,100	100
LBXND5050WDL3R3NMG	NRS5024T 3R3NMGJ8	3.3	±30%	41	0.043	3,100	2,400	100
LBXND5050WDL4R7MMG	NRS5024T 4R7MMGJ8	4.7	±20%	37	0.055	2,700	2,000	100
LBXND5050WDL6R8MMG	NRS5024T 6R8MMGJ8	6.8	±20%	28	0.080	2,200	1,600	100
LBXND5050WDL100MMG	NRS5024T 100MMGJ8	10	±20%	21	0.125	1,700	1,200	100
LBXND5050WDL150MMG	NRS5024T 150MMGJ8	15	±20%	18	0.170	1,400	1,000	100
LBXND5050WDL220MMG	NRS5024T 220MMGJ8	22	±20%	15	0.230	1,200	820	100
LBXND5050WDL330MMG	NRS5024T 330MMGJ8	33	±20%	11	0.370	1,000	630	100

● 5050XA/5050XK type

New part number	Old part number (for reference)	Nominal inductance [μH]	Inductance tolerance	Self-resonant frequency [MHz] (min.)	DC Resistance [Ω] (±30%)	Rated current ※) [mA]		Measuring frequency [kHz]
						Saturation current Idc1	Temperature rise current Idc2	
LBXND5050XATR47NMG	NRS5030T R47NMGJ8	0.47	±30%	185	0.010	9,000	5,000	100
LBXND5050XAT1R0NMG	NRS5030T 1R0NMGJ8	1.0	±30%	110	0.015	6,600	4,000	100
LBXND5050XAT2R2NMG	NRS5030T 2R2NMGJ8	2.2	±30%	46	0.023	4,200	3,500	100
LBXND5050XAT3R3MMG	NRS5030T 3R3MMGJ8	3.3	±20%	36	0.030	3,600	3,000	100
LBXND5050XAT4R7MMG	NRS5030T 4R7MMGJ8	4.7	±20%	31	0.035	3,100	2,600	100
LBXND5050XAT6R8MMG	NRS5030T 6R8MMGJ8	6.8	±20%	22	0.052	2,500	2,300	100
LBXND5050XAT100MMG	NRS5030T 100MMGJ8	10	±20%	20	0.070	2,100	1,700	100
LBXND5050XKT150MMG	NRS5030T 150MMGJ8	15	±20%	14	0.125	1,600	1,400	100
LBXND5050XKT220MMG	NRS5030T 220MMGJ8	22	±20%	13	0.180	1,400	1,050	100
LBXND5050XKT330MMG	NRS5030T 330MMGJ8	33	±20%	10	0.225	1,150	800	100
LBXND5050XKT470MMG	NRS5030T 470MMGJ8	47	±20%	9	0.325	950	700	100

● 5050YA/5050YK type

New part number	Old part number (for reference)	Nominal inductance [μH]	Inductance tolerance	Self-resonant frequency [MHz] (min.)	DC Resistance [Ω] (±30%)	Rated current ※) [mA]		Measuring frequency [kHz]
						Saturation current Idc1	Temperature rise current Idc2	
LBXND5050YAL1R5NMG	NRS5040T 1R5NMGJ8	1.5	±30%	60	0.017	6,400	4,500	100
LBXND5050YAL2R2NMG	NRS5040T 2R2NMGJ8	2.2	±30%	42	0.022	5,000	3,700	100
LBXND5050YAL3R3NMG	NRS5040T 3R3NMGJ8	3.3	±30%	32	0.027	4,000	3,300	100
LBXND5050YAL4R7NMG	NRS5040T 4R7NMGJ8	4.7	±30%	28	0.029	3,300	3,100	100
LBXND5050YAL6R8MMG	NRS5040T 6R8MMGJ8	6.8	±20%	21	0.049	2,800	2,400	100
LBXND5050YAL100MMG	NRS5040T 100MMGJ8	10	±20%	18	0.056	2,300	2,100	100
LBXND5050YKL150MMG	NRS5040T 150MMGJ8	15	±20%	13	0.080	2,000	1,800	100
LBXND5050YKL220MMG	NRS5040T 220MMGJ8	22	±20%	9	0.126	1,500	1,400	100
LBXND5050YKL330MMG	NRS5040T 330MMGJ8	33	±20%	7	0.180	1,300	1,200	100
LBXND5050YKL470MMG	NRS5040T 470MMGJ8	47	±20%	6	0.310	1,100	900	100

● 6060KK type

New part number	Old part number (for reference)	Nominal inductance [μH]	Inductance tolerance	Self-resonant frequency [MHz] (min.)	DC Resistance [Ω] (±20%)	Rated current ※) [mA]		Measuring frequency [kHz]
						Saturation current Idc1	Temperature rise current Idc2	
LBXND6060KKT1R5MMG	NRS6010T 1R5MMGF8	1.5	±20%	77	0.090	2,400	1,900	100
LBXND6060KKT2R2MMG	NRS6010T 2R2MMGF8	2.2	±20%	56	0.110	1,900	1,700	100
LBXND6060KKT3R3MMG	NRS6010T 3R3MMGF8	3.3	±20%	42	0.135	1,600	1,500	100
LBXND6060KKT4R7MMG	NRS6010T 4R7MMGF8	4.7	±20%	36	0.165	1,300	1,400	100
LBXND6060KKT6R8MMG	NRS6010T 6R8MMGF8	6.8	±20%	30	0.220	1,200	1,200	100
LBXND6060KKT100MMG	NRS6010T 100MMGF8	10	±20%	25	0.270	1,000	1,100	100
LBXND6060KKT220MMG	NRS6010T 220MMGF8	22	±20%	12	0.580	650	700	100

● 6060MK type

New part number	Old part number (for reference)	Nominal inductance [μH]	Inductance tolerance	Self-resonant frequency [MHz] (min.)	DC Resistance [Ω] (±20%)	Rated current ※) [mA]		Measuring frequency [kHz]
						Saturation current Idc1	Temperature rise current Idc2	
LBXND6060MKT1R0NMG	NRS6012T 1R0NMGJ8	1.0	±30%	95	0.050	3,000	2,400	100
LBXND6060MKT1R5NMG	NRS6012T 1R5NMGJ8	1.5	±30%	69	0.067	2,600	2,100	100
LBXND6060MKT2R5NMG	NRS6012T 2R5NMGJ8	2.5	±30%	45	0.090	2,100	1,800	100
LBXND6060MKT3R3NMG	NRS6012T 3R3NMGJ8	3.3	±30%	42	0.105	1,800	1,700	100
LBXND6060MKT4R7MMG	NRS6012T 4R7MMGJ8	4.7	±20%	36	0.125	1,600	1,550	100
LBXND6060MKT5R3MMG	NRS6012T 5R3MMGJ8	5.3	±20%	34	0.125	1,500	1,550	100
LBXND6060MKT6R8MMG	NRS6012T 6R8MMGJ8	6.8	±20%	30	0.165	1,300	1,350	100
LBXND6060MKT100MMG	NRS6012T 100MMGJ8	10	±20%	22	0.200	1,000	1,200	100
LBXND6060MKT150MMG	NRS6012T 150MMGJ8	15	±20%	18	0.295	800	800	100
LBXND6060MKT220MMG	NRS6012T 220MMGJ8	22	±20%	12	0.465	760	650	100
LBXND6060MKT330MMG	NRS6012T 330MMGJ8	33	±20%	8	0.580	590	550	100
LBXND6060MKT470MMG	NRS6012T 470MMGJ8	47	±20%	6	0.965	520	460	100
LBXND6060MKT680MMG	NRS6012T 680MMGJ8	68	±20%	3	1.16	440	410	100
LBXND6060MKT101MMG	NRS6012T 101MMGJ8	100	±20%	1	1.67	350	320	100

※) The saturation current 8alue (Idc1) is the DC current 8alue ha8ing inductance decrease down to 30%. (at 20°C)

※) The temperature rise current 8alue (Idc2) is the DC current 8alue ha8ing temperature increase up to 40°C. (at 20°C)

※) The rated current is the DC current 8alue that satisfies both of current 8alue saturation current 8alue and temperature rise current 8alue.

■ PART NUMBER

● 6060PK type

New part number	Old part number (for reference)	Nominal inductance [μH]	Inductance tolerance	Self-resonant frequency [MHz] (min.)	DC Resistance [Ω] (±20%)	Rated current ※) [mA]		Measuring frequency [kHz]
						Saturation current Idc1	Temperature rise current Idc2	
LBXND6060PKT1R2NMG	NRS6014T 1R2NMG8	1.2	±30%	77	0.042	4,000	2,750	100
LBXND6060PKT2R2NMG	NRS6014T 2R2NMG8	2.2	±30%	61	0.055	3,000	2,300	100
LBXND6060PKT3R3NMG	NRS6014T 3R3NMG8	3.3	±30%	41	0.075	2,500	2,000	100
LBXND6060PKT4R7MMG	NRS6014T 4R7MMG8	4.7	±20%	36	0.090	2,000	1,900	100
LBXND6060PKT6R8MMG	NRS6014T 6R8MMG8	6.8	±20%	30	0.115	1,700	1,650	100
LBXND6060PKT100MMG	NRS6014T 100MMG8	10	±20%	24	0.140	1,400	1,400	100
LBXND6060PKT150MMG	NRS6014T 150MMG8	15	±20%	20	0.210	1,150	1,200	100
LBXND6060PKT220MMG	NRS6014T 220MMG8	22	±20%	16	0.300	950	1,000	100

● 6060WK type

New part number	Old part number (for reference)	Nominal inductance [μH]	Inductance tolerance	Self-resonant frequency [MHz] (min.)	DC Resistance [Ω] (±20%)	Rated current ※) [mA]		Measuring frequency [kHz]
						Saturation current Idc1	Temperature rise current Idc2	
LBXND6060WKL0R8NMG	NRS6020T 0R8NMG8	0.8	±30%	110	0.020	6,400	4,100	100
LBXND6060WKL1R5NMG	NRS6020T 1R5NMG8	1.5	±30%	93	0.026	4,300	3,600	100
LBXND6060WKL2R2NMG	NRS6020T 2R2NMG8	2.2	±30%	73	0.034	3,200	2,900	100
LBXND6060WKL3R3NMG	NRS6020T 3R3NMG8	3.3	±30%	55	0.040	2,800	2,750	100
LBXND6060WKL4R7NMG	NRS6020T 4R7NMG8	4.7	±30%	43	0.058	2,400	2,150	100
LBXND6060WKL6R8NMG	NRS6020T 6R8NMG8	6.8	±30%	30	0.085	2,000	1,800	100
LBXND6060WKL100MMG	NRS6020T 100MMG8	10	±20%	18	0.125	1,900	1,500	100
LBXND6060WKL220MMG	NRS6020T 220MMG8	22	±20%	11	0.290	1,250	950	100

● 6060WH type

New part number	Old part number (for reference)	Nominal inductance [μH]	Inductance tolerance	Self-resonant frequency [MHz] (min.)	DC Resistance [Ω] (±30%)	Rated current ※) [mA]		Measuring frequency [kHz]
						Saturation current Idc1	Temperature rise current Idc2	
LBXND6060WHL0R9NMG	NRS6028T 0R9NMG8	0.9	±30%	90	0.013	6,700	4,600	100
LBXND6060WHL1R5NMG	NRS6028T 1R5NMG8	1.5	±30%	78	0.016	5,100	4,200	100
LBXND6060WHL2R2NMG	NRS6028T 2R2NMG8	2.2	±30%	68	0.020	4,200	3,700	100
LBXND6060WHL3R0NMG	NRS6028T 3R0NMG8	3.0	±30%	55	0.023	3,600	3,400	100
LBXND6060WHL4R7MMG	NRS6028T 4R7MMG8	4.7	±20%	39	0.031	2,700	3,000	100
LBXND6060WHL6R8MMG	NRS6028T 6R8MMG8	6.8	±20%	25	0.043	2,600	2,500	100
LBXND6060WHL100MMG	NRS6028T 100MMG8	10	±20%	20	0.065	1,900	1,900	100
LBXND6060WHL150MMG	NRS6028T 150MMG8	15	±20%	17	0.095	1,600	1,800	100
LBXND6060WHL220MMG	NRS6028T 220MMG8	22	±20%	12	0.135	1,300	1,400	100
LBXND6060WHL330MMG	NRS6028T 330MMG8	33	±20%	10	0.220	1,100	1,100	100
LBXND6060WHL470MMG	NRS6028T 470MMG8	47	±20%	8	0.300	1,000	920	100
LBXND6060WHL680MMG	NRS6028T 680MMG8	68	±20%	5	0.420	800	770	100
LBXND6060WHL101MMG	NRS6028T 101MMG8	100	±20%	3	0.600	650	660	100

● 6060YE type

New part number	Old part number (for reference)	Nominal inductance [μH]	Inductance tolerance	Self-resonant frequency [MHz] (min.)	DC Resistance [Ω] (±30%)	Rated current ※) [mA]		Measuring frequency [kHz]
						Saturation current Idc1	Temperature rise current Idc2	
LBXND6060YEL1R0NMG	NRS6045T 1R0NMG8	1.0	±30%	110	0.014	9,800	4,500	100
LBXND6060YEL1R3NMG	NRS6045T 1R3NMG8	1.3	±30%	95	0.016	8,200	4,200	100
LBXND6060YEL1R8NMG	NRS6045T 1R8NMG8	1.8	±30%	80	0.019	7,200	3,900	100
LBXND6060YEL2R3NMG	NRS6045T 2R3NMG8	2.3	±30%	60	0.022	6,400	3,600	100
LBXND6060YEL3R0NMG	NRS6045T 3R0NMG8	3.0	±30%	45	0.024	5,600	3,300	100
LBXND6060YEL4R5MMG	NRS6045T 4R5MMG8	4.5	±20%	25	0.030	4,400	3,100	100
LBXND6060YEL6R3MMG	NRS6045T 6R3MMG8	6.3	±20%	15	0.036	3,600	3,000	100
LBXND6060YEL100MMG	NRS6045T 100MMG8	10	±20%	12	0.046	3,100	2,400	100
LBXND6060YEL150MMG	NRS6045T 150MMG8	15	±20%	10	0.070	2,500	1,900	100
LBXND6060YEL220MMG	NRS6045T 220MMG8	22	±20%	7	0.107	2,000	1,600	100
LBXND6060YEL330MMG	NRS6045T 330MMG8	33	±20%	6	0.141	1,650	1,400	100
LBXND6060YEL470MMG	NRS6045T 470MMG8	47	±20%	5	0.211	1,400	1,150	100
LBXND6060YEL680MMG	NRS6045T 680MMG8	68	±20%	4	0.304	1,100	950	100
LBXND6060YEL101MMG	NRS6045T 101MMG8	100	±20%	3	0.466	900	750	100

● 8080XK type

New part number	Old part number (for reference)	Nominal inductance [μH]	Inductance tolerance	Self-resonant frequency [MHz] (min.)	DC Resistance [Ω] (±30%)	Rated current ※) [mA]		Measuring frequency [kHz]
						Saturation current Idc1	Temperature rise current Idc2	
LBXNH8080XKL1R0NMG	NRS8030T 1R0NMG8	1.0	±30%	120	0.009	7,800	6,200	100
LBXNH8080XKL1R5NMG	NRS8030T 1R5NMG8	1.5	±30%	80	0.012	6,200	5,300	100
LBXNH8080XKL2R2NMG	NRS8030T 2R2NMG8	2.2	±30%	60	0.015	4,900	4,800	100
LBXNH8080XKL3R3NMG	NRS8030T 3R3NMG8	3.3	±20%	50	0.019	4,200	4,300	100
LBXNH8080XKL4R7MMG	NRS8030T 4R7MMG8	4.7	±20%	40	0.022	3,600	4,000	100
LBXNH8080XKL6R8MMG	NRS8030T 6R8MMG8	6.8	±20%	32	0.029	3,000	3,400	100
LBXNH8080XKL100MMG	NRS8030T 100MMG8	10	±20%	27	0.033	2,400	3,000	100
LBXNH8080XKL150MMG	NRS8030T 150MMG8	15	±20%	20	0.060	2,000	2,200	100
LBXNH8080XKL220MMG	NRS8030T 220MMG8	22	±20%	16	0.070	1,750	1,900	100
LBXNH8080XKL330MMG	NRS8030T 330MMG8	33	±20%	13	0.120	1,300	1,500	100
LBXNH8080XKL470MMG	NRS8030T 470MMG8	47	±20%	11	0.170	1,100	1,300	100

※) The saturation current 8alue (Idc1) is the DC current 8alue ha8ing inductance decrease down to 30%. (at 20°C)  
 ※) The temperature rise current 8alue (Idc2) is the DC current 8alue ha8ing temperature increase up to 40°C. (at 20°C)  
 ※) The rated current is the DC current 8alue that satisfies both of current 8alue saturation current 8alue and temperature rise current 8alue.

▶ This catalog contains the typical specification only due to the limitation of space. When you consider the purchase of our products, please check our specification.  
 For details of each product (characteristics graph, reliability information, precautions for use, and so on), see our Web site (<http://www.ty-top.com/>).

## PART NUMBER

## 8080YB/8080YK type

New part number	Old part number (for reference)	Nominal inductance [ $\mu$ H]	Inductance tolerance	Self-resonant frequency [MHz] (min.)	DC Resistance [ $\Omega$ ] ( $\pm 30\%$ )	Rated current ※) [mA]		Measuring frequency [kHz]
						Saturation current Idc1	Temperature rise current Idc2	
LBXNH8080YBL0R9NJG	NRS8040T 0R9NJGJ8	0.9	$\pm 30\%$	85	0.006	13,000	7,800	100
LBXNH8080YBL1R4NJG	NRS8040T 1R4NJGJ8	1.4	$\pm 30\%$	63	0.007	10,000	7,000	100
LBXNH8080YBL2R0NJG	NRS8040T 2R0NJGJ8	2.0	$\pm 30\%$	50	0.009	8,100	6,300	100
LBXNH8080YBL3R6NJG	NRS8040T 3R6NJGJ8	3.6	$\pm 30\%$	34	0.015	6,400	4,900	100
LBXNH8080YBL4R7NJG	NRS8040T 4R7NJGJ8	4.7	$\pm 30\%$	30	0.018	5,400	4,100	100
LBXNH8080YBL6R8NJG	NRS8040T 6R8NJGJ8	6.8	$\pm 30\%$	24	0.025	4,400	3,700	100
LBXNH8080YKL100MJG	NRS8040T 100MJGJ8	10	$\pm 20\%$	22	0.034	3,800	3,100	100
LBXNH8080YKL150MJG	NRS8040T 150MJGJ8	15	$\pm 20\%$	16	0.050	2,900	2,400	100
LBXNH8080YKL220MJG	NRS8040T 220MJGJ8	22	$\pm 20\%$	13	0.066	2,400	2,200	100
LBXNH8080YKL330MJG	NRS8040T 330MJGK8	33	$\pm 20\%$	12	0.100	2,000	1,700	100
LBXNH8080YKL470MJG	NRS8040T 470MJGK8	47	$\pm 20\%$	8	0.140	1,500	1,500	100
LBXNH8080YKL680MJG	NRS8040T 680MJGK8	68	$\pm 20\%$	7	0.210	1,300	1,200	100
LBXNH8080YKL101MJG	NRS8040T 101MJGK8	100	$\pm 20\%$	6	0.280	1,100	1,000	100

※) The saturation current value (Idc1) is the DC current value having inductance decrease down to 30%. (at 20°C)

※) The temperature rise current value (Idc2) is the DC current value having temperature increase up to 40°C. (at 20°C)

※) The rated current is the DC current value that satisfies both of current value saturation current value and temperature rise current value.

Derating of Rated Current

LBXN/LBXP series

Derating of current is necessary for LBXN/LBXP series depending on ambient temperature. Please refer to the chart shown below for appropriate derating of current.

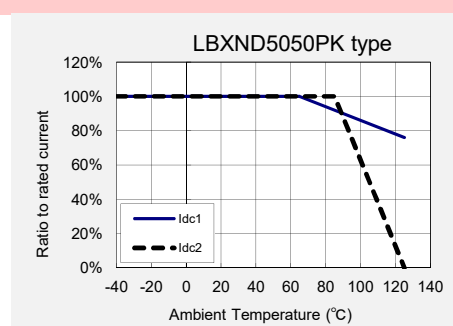
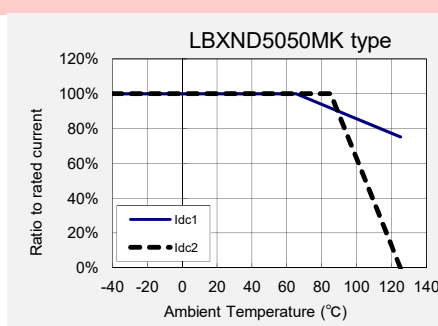
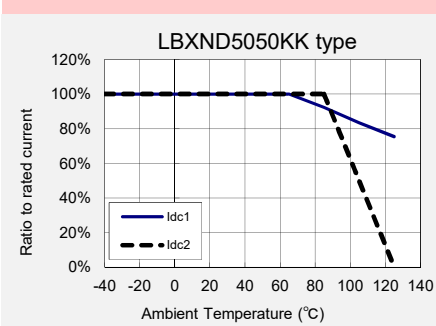
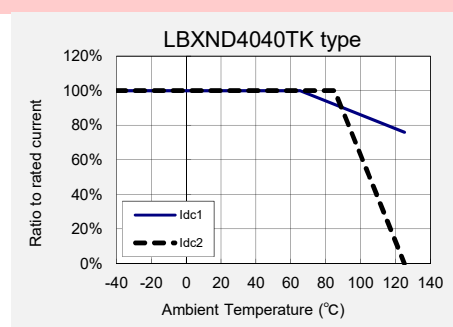
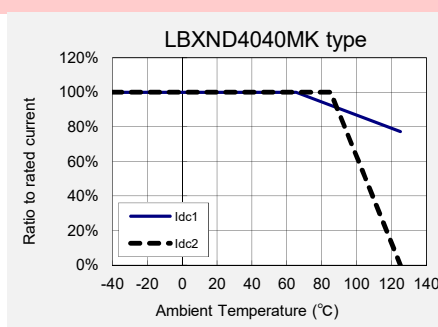
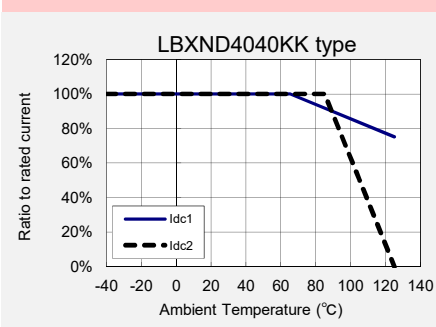
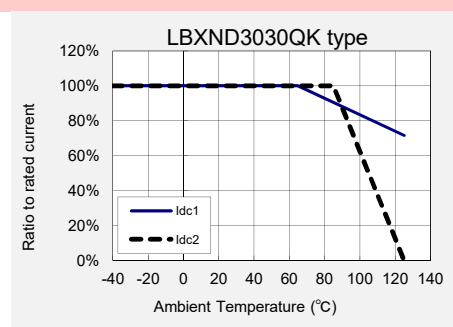
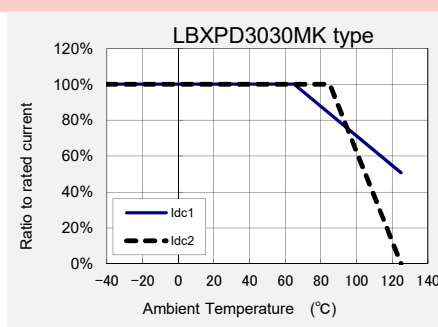
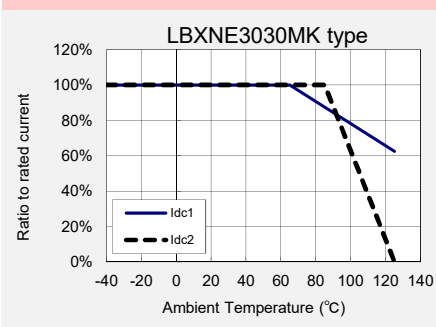
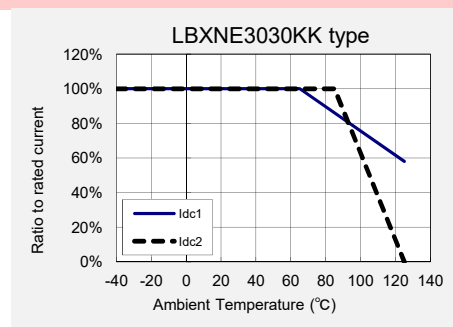
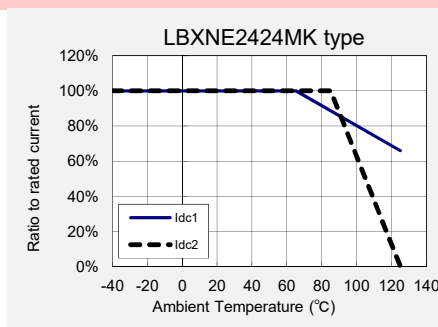
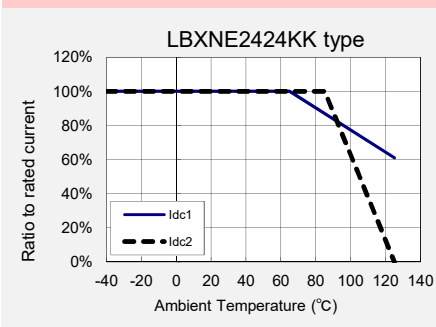
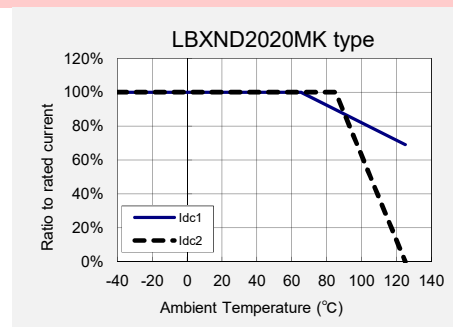
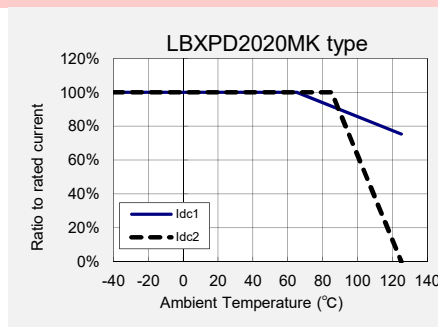
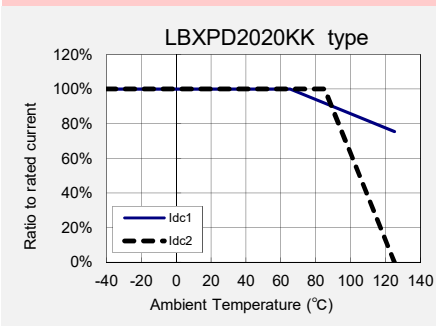

▶ This catalog contains the typical specification only due to the limitation of space. When you consider the purchase of our products, please check our specification. For details of each product (characteristics graph, reliability information, precautions for use, and so on), see our Web site (<http://www.ty-top.com/>).

Derating of Rated Current

LBXN/LBXP series

Derating of current is necessary for LBXN/LBXP series depending on ambient temperature. Please refer to the chart shown below for appropriate derating of current.

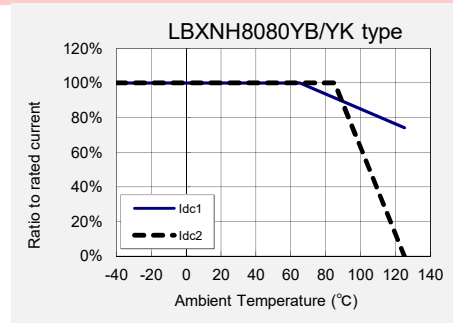
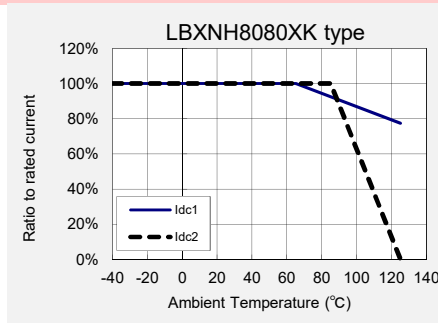
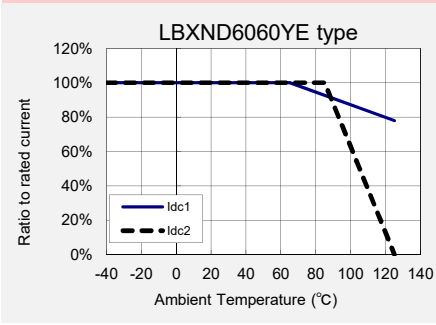
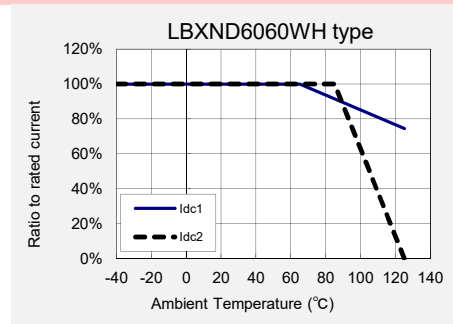
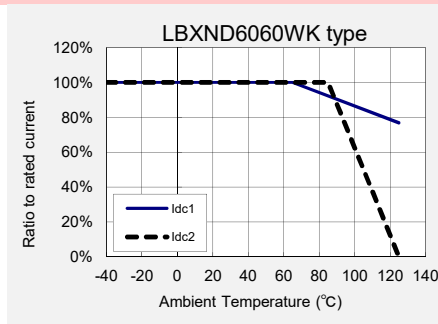
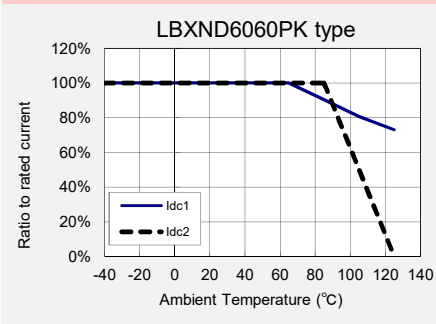
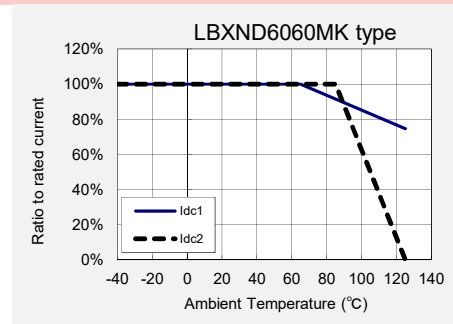
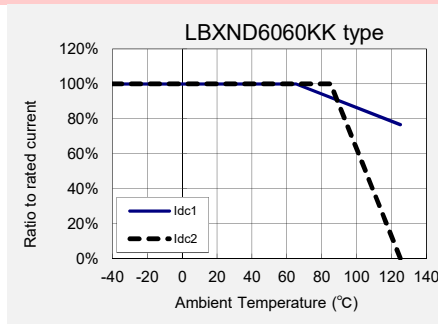
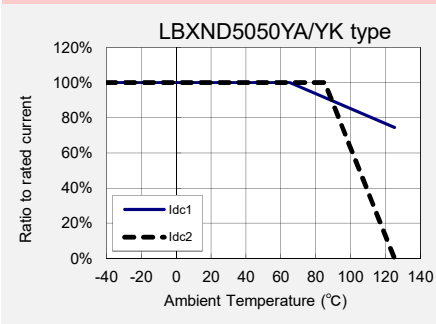
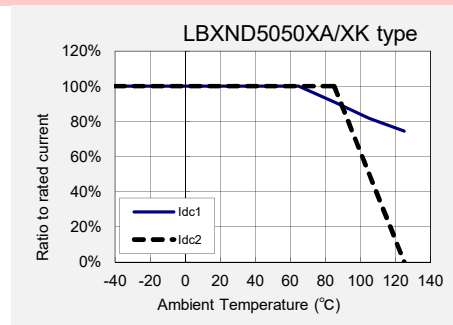
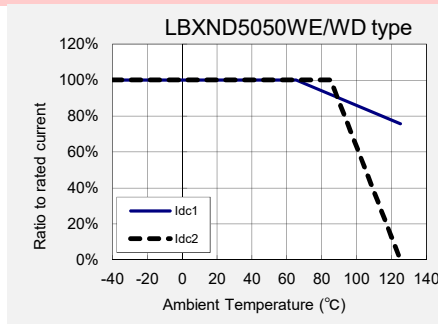
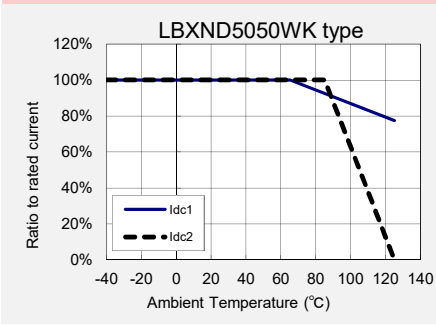

► This catalog contains the typical specification only due to the limitation of space. When you consider the purchase of our products, please check our specification. For details of each product (characteristics graph, reliability information, precautions for use, and so on), see our Web site (<http://www.ty-top.com/>).

Wire-wound Ferrite Power Inductors LSXN/LSXP/LCXN/LCXP/LBXN/LBXP/  
 LLXN/LLXP/LMXN/LMXP series  
 Wire-wound Ferrite Power Inductors LAXH/LCXH/LBXH/LMXH series  
 Wire-wound Ferrite Inductors for Class D Amplifier LCXA

■ PACKAGING

① Minimum Quantity

Type	Standard Quantity [pcs]
	Tape & Reel
2020KK	2500
2020MK	2500
2424KK	2500
2424MK	2500
3030KK	2000
3030MK	2000
3030QK	2000
4040KK	5000
4040MK	4500
4040TK	3500
4040WK	700

Type	Standard Quantity [pcs]
	Tape & Reel
5050KK	1000
5050MK	1000
5050PK	1000
5050WB	800
5050WK	800
5050WD	2500
5050WE	2500
5050XK	500
5050XA	500
5050YA	1500
5050YK	1500
6060KK	1000
6060MK	1000
6060PK	1000
6060WK	2500
6060WH	2000
6060XK	2000
6060YE	1500
8080XK	1000
8080YK	1000
8080YB	1000

② Tape Material

● Embossed Tape

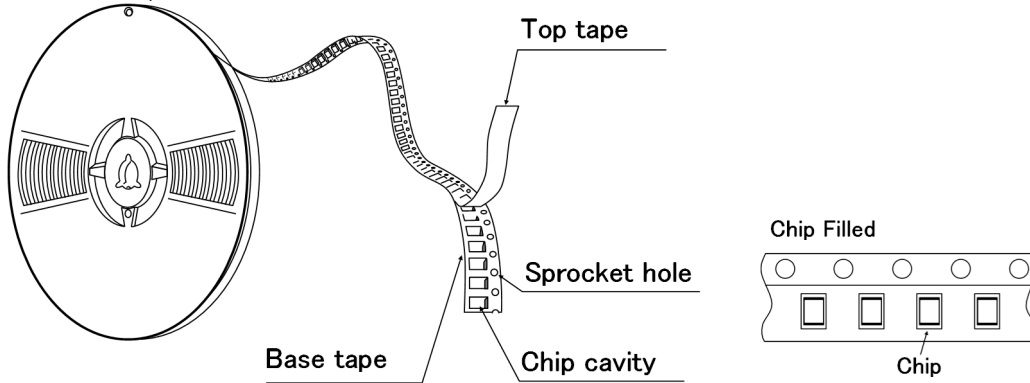

③ Taping dimensions

● Embossed tape 8mm wide (0.315 inches wide)

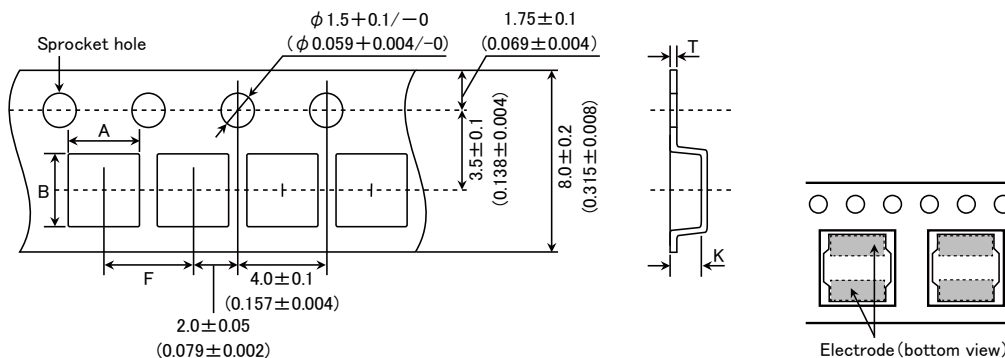

► This catalog contains the typical specification only due to the limitation of space. When you consider the purchase of our products, please check our specification. For details of each product (characteristics graph, reliability information, precautions for use, and so on), see our Web site (<http://www.ty-top.com/>).



Type	Chip cavity		Insertion pitch F	Tape thickness	
	A	B		T	K
2020KK 2020MK	2.2±0.1 (0.102±0.004)	2.2±0.1 (0.102±0.004)	4.0±0.1 (0.157±0.004)	0.25±0.05 (0.009±0.002)	1.3±0.1 (0.051±0.004)
2424KK 2424MK	2.6±0.1 (0.087±0.004)	2.6±0.1 (0.102±0.004)		0.25±0.05 (0.009±0.002)	1.3±0.1 (0.051±0.004)
3030KK	3.2±0.1 (0.126±0.004)	3.2±0.1 (0.126±0.004)		0.3±0.05 (0.012±0.002)	1.4±0.1 (0.055±0.004)
3030MK					1.6±0.1 (0.063±0.004)
3030QK					1.9±0.1 (0.075±0.004)

Unit: mm (inch)

● Embossed tape 12mm wide (0.47 inches wide)

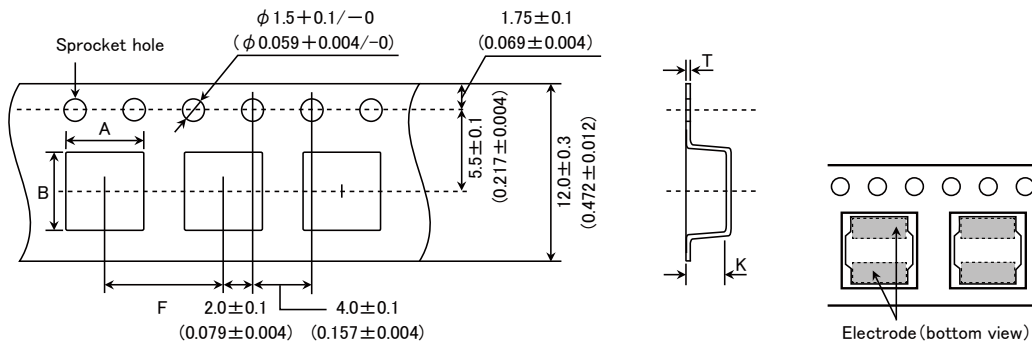

Type	Chip cavity		Insertion pitch F	Tape thickness		
	A	B		T	K	
4040KK	4.3±0.1 (0.169±0.004)	4.3±0.1 (0.169±0.004)	8.0±0.1 (0.315±0.004)	0.3±0.1 (0.012±0.004)	1.4±0.1 (0.055±0.004)	
4040MK					1.6±0.1 (0.063±0.004)	
4040TK 4040WK					2.1±0.1 (0.083±0.004)	
5050KK	5.25±0.1 (0.207±0.004)	5.25±0.1 (0.207±0.004)			1.4±0.1 (0.055±0.004)	
5050MK						1.4±0.1 (0.055±0.004)
5050PK						1.6±0.1 (0.063±0.004)
5050WB 5050WK				2.3±0.1 (0.091±0.004)		
5050WD 5050WE				2.7±0.1 (0.106±0.004)		
5050XK 5050XA				5.15±0.1 (0.203±0.004)		5.15±0.1 (0.203±0.004)
5050YK 5050YA	5.15±0.1 (0.203±0.004)	5.15±0.1 (0.203±0.004)		4.2±0.1 (0.165±0.004)		
6060KK	6.3±0.1 (0.248±0.004)	6.3±0.1 (0.248±0.004)		0.4±0.1 (0.016±0.004)	1.4±0.1 (0.055±0.004)	
6060MK					1.6±0.1 (0.063±0.004)	
6060PK			1.6±0.1 (0.063±0.004)			
6060WK			2.3±0.1 (0.090±0.004)			
6060WH 6060XK			3.1±0.1 (0.122±0.004)			
6060YE			4.7±0.1 (0.185±0.004)			

Unit: mm (inch)

► This catalog contains the typical specification only due to the limitation of space. When you consider the purchase of our products, please check our specification. For details of each product (characteristics graph, reliability information, precautions for use, and so on), see our Web site (<http://www.ty-top.com/>).

● Embossed tape 16mm wide (0.63 inches wide)

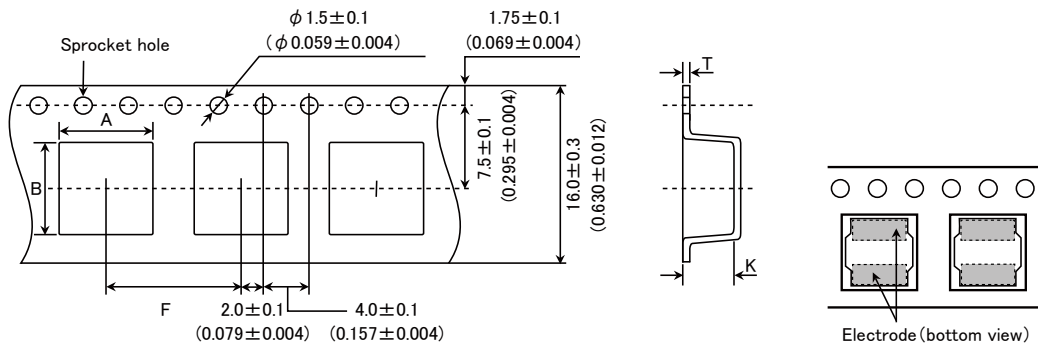

Type	Chip cavity		Insertion pitch F	Tape thickness	
	A	B		T	K
8080XK	$8.3 \pm 0.1$ ( $0.327 \pm 0.004$ )	$8.3 \pm 0.1$ ( $0.327 \pm 0.004$ )	$12.0 \pm 0.1$ ( $0.472 \pm 0.004$ )	$0.5 \pm 0.1$ ( $0.020 \pm 0.004$ )	$3.4 \pm 0.1$ ( $0.134 \pm 0.004$ )
8080YK					$4.5 \pm 0.1$ ( $0.177 \pm 0.004$ )
8080YB					$4.5 \pm 0.1$ ( $0.177 \pm 0.004$ )

Unit: mm (inch)

④ Leader and Blank portion

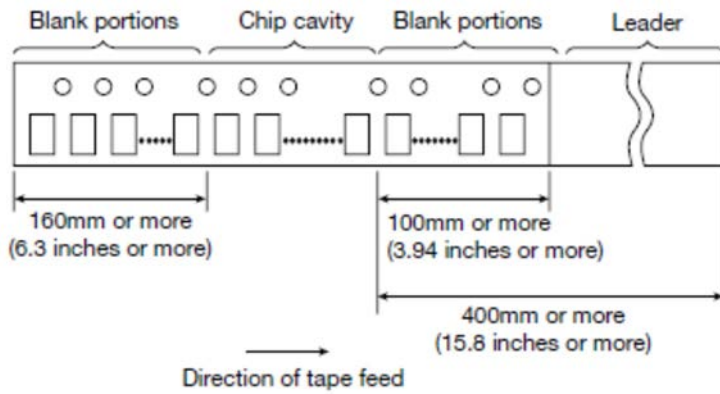

⑤ Reel size

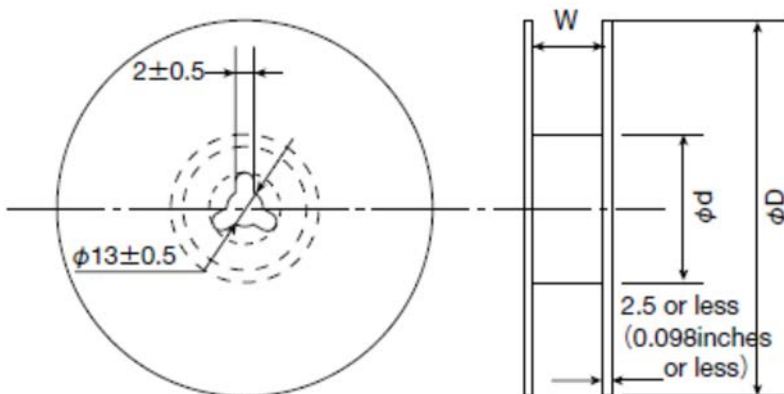

► This catalog contains the typical specification only due to the limitation of space. When you consider the purchase of our products, please check our specification. For details of each product (characteristics graph, reliability information, precautions for use, and so on), see our Web site (<http://www.ty-top.com/>).

Type	Reel size (Reference values)		
	$\phi D$	$\phi d$	W
2020KK	180±0.5 (7.087±0.019)	60±1.0 (2.36±0.04)	10.0±1.5 (0.394±0.059)
2020MK			
2424KK			
2424MK			
3030KK			
3030MK			
3030QK			
4040WK	180±3.0 (7.087±0.118)	60±2.0 (2.36±0.08)	14.0±1.5 (0.551±0.059)
5050KK			
5050MK			
5050PK			
5050WB			
5050WK			
5050XK			
5050XA			
6060KK			
6060MK			
6060PK			

Unit: mm (inch)

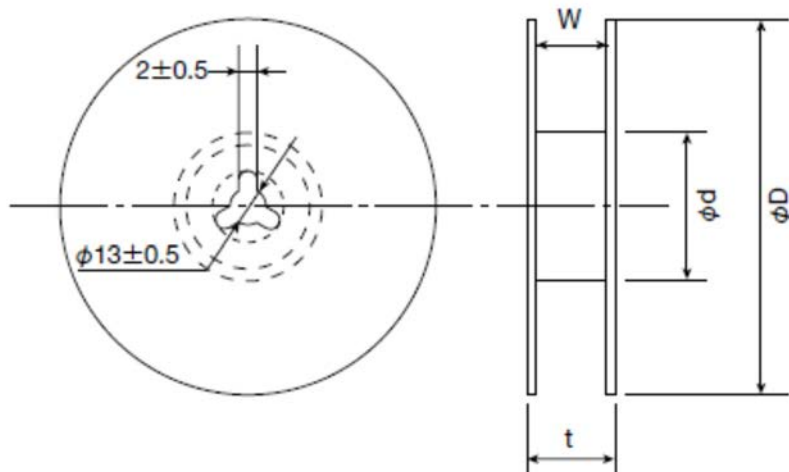

Type	Reel size (Reference values)			
	$\phi D$	$\phi d$	t (max.)	W
4040KK	330±3.0 (12.99±0.118)	80±2.0 (3.15±0.078)	18.5 (0.72)	13.5±1.0 (0.531±0.04)
4040MK				
4040TK				
5050WD				
5050WE				
5050YA				
5050YK				
6060WK				
6060WH				
6060XK				
6060YE				
8080XK			22.5 (0.89)	17.5±1.0 (0.689±0.04)
8080YK				
8080YB				
8080YB				

Unit: mm (inch)

### ⑥ Top Tape Strength

The top tape requires a peel-off force of 0.1 to 1.3N in the direction of the arrow as illustrated below.

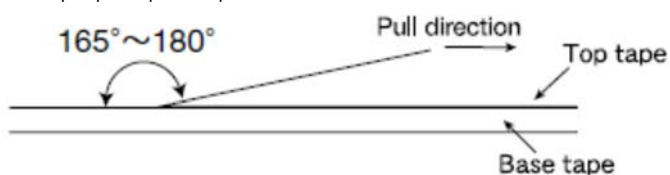

► This catalog contains the typical specification only due to the limitation of space. When you consider the purchase of our products, please check our specification. For details of each product (characteristics graph, reliability information, precautions for use, and so on), see our Web site (<http://www.ty-top.com/>).

**Wire-wound Ferrite Power Inductors LBXN/LBXP series  
for Telecommunications Infrastructure and Industrial Equipment**  
**Wire-wound Ferrite Power Inductors LMXN/LMXP series  
for Medical Devices classified as GHTF Class C (Japan Class III)**

■ RELIABILITY DATA

1. Operating Temperature Range

Specified Value     −40~ +125°C (Including self-generated heat)

Test Methods and Remarks     Including self-generated heat

2. Storage Temperature Range

Specified Value     −40~ +85°C

Test Methods and Remarks     −5 to 40°C for the product with taping.

3. Rated current

Specified Value     Within the specified tolerance

4. Inductance

Specified Value     Within the specified tolerance

Test Methods and Remarks     Measuring equipment     : LCR Meter (HP 4285A or equivalent)  
Measuring frequency     : 100kHz, 1V

5. DC Resistance

Specified Value     Within the specified tolerance

Test Methods and Remarks     Measuring equipment     : DC ohmmeter (HIOKI 3227 or equivalent)

6. Self resonance frequency

Specified Value     Within the specified tolerance (2020 type: —)

Test Methods and Remarks     Measuring equipment     : Impedance analyzer/material analyzer (HP4291A or equivalent HP4191A, 4192A or equivalent)

7. Temperature characteristic

Specified Value     Inductance change : Within  $\pm 20\%$

Test Methods and Remarks     Measurement of inductance shall be taken at temperature range within  $-40^{\circ}\text{C} \sim +85^{\circ}\text{C}$ .  
With reference to inductance value at  $+20^{\circ}\text{C}$ ., change rate shall be calculated.  
Change of maximum inductance deviation in step 1 to 5

Step	Temperature (°C)
1	20
2	Minimum operating temperature
3	20 (Standard temperature)
4	Maximum operating temperature
5	20



#### 14. Solderability

Specified Value	At least 90% of surface of terminal electrode is covered by new solder.	
Test Methods and Remarks	The test samples shall be dipped in flux, and then immersed in molten solder as shown in below table. Flux : Ethanol solution containing rosin 25%.	
	Solder Temperature	245±5°C
	Time	5±1.0 sec.
※Immersion depth : All sides of mounting terminal shall be immersed.		

#### 15. Resistance to soldering heat

Specified Value	Inductance change : Within ±10% No significant abnormality in appearance.	
Test Methods and Remarks	The test sample shall be exposed to reflow oven at 230±5°C for 40 seconds, with peak temperature at 260±5°C for 5 seconds, 2 times.	
	Test board material	: glass epoxy-resin
	Test board thickness	: 1.0mm

#### 16. Thermal shock

Specified Value	Inductance change : Within ±10% No significant abnormality in appearance.		
Test Methods and Remarks	The test samples shall be soldered to the test board by the reflow. The test samples shall be placed at specified temperature for specified time by step 1 to step 4 as shown in below table in sequence. The temperature cycle shall be repeated 1000 cycles.		
	Conditions of 1 cycle		
	Step	Temperature (°C)	Duration (min)
	1	-40±3	30±3
	2	Room temperature	Within 3
3	+85±2	30±3	
4	Room temperature	Within 3	

#### 17. Damp heat

Specified Value	Inductance change : Within ±10% No significant abnormality in appearance.	
Test Methods and Remarks	The test samples shall be soldered to the test board by the reflow.	
	The test samples shall be placed in thermostatic oven set at specified temperature and humidity as shown in below table.	
	Temperature	60±2°C
	Humidity	90~95%RH
	Time	1000+24/-0 hour

#### 18. Loading under damp heat

Specified Value	Inductance change : Within ±10% No significant abnormality in appearance.	
Test Methods and Remarks	The test samples shall be soldered to the test board by the reflow.	
	The test samples shall be placed in thermostatic oven set at specified temperature and humidity and applied the rated current continuously as shown in below table.	
	Temperature	60±2°C
	Humidity	90~95%RH
	Applied current	Rated current
	Time	1000+24/-0 hour

#### 19. Low temperature life test

Specified Value	Inductance change : Within ±10% No significant abnormality in appearance.	
Test Methods and Remarks	The test samples shall be soldered to the test board by the reflow. After that, the test samples shall be placed at test conditions as shown in below table.	
	Temperature	-40±2°C
	Time	1000+24/-0 hour

#### 20. High temperature life test

Specified Value	—
-----------------	---

▶ This catalog contains the typical specification only due to the limitation of space. When you consider the purchase of our products, please check our specification. For details of each product (characteristics graph, reliability information, precautions for use, and so on), see our Web site (<http://www.ty-top.com/>).

## 21. Loading at high temperature life test

Specified Value	Inductance change : Within $\pm 10\%$ No significant abnormality in appearance.	
Test Methods and Remarks	The test samples shall be soldered to the test board by the reflow soldering.	
	Temperature	$85 \pm 2^\circ\text{C}$
	Applied current	Rated current
	Time	$1000 + 24 / - 0$ hour

## 22. Standard condition

Specified Value	Standard test condition : Unless otherwise specified, temperature is $20 \pm 15^\circ\text{C}$ and $65 \pm 20\%$ of relative humidity. When there is any question concerning measurement result: In order to provide correlation data, the test shall be condition of $20 \pm 2^\circ\text{C}$ of temperature, $65 \pm 5\%$ relative humidity. Inductance is in accordance with our measured value.
-----------------	--



**Wire-wound Ferrite Power Inductors LAYP series for Automotive Powertrain and safety**  
**Wire-wound Ferrite Power Inductors LAXH series for Automotive Powertrain and safety**  
**Wire-wound Ferrite Power Inductors LCXN/LCXP series for Automotive Body & Chassis and Infotainment**  
**Wire-wound Ferrite Power Inductors LCXH series for Automotive Body & Chassis and Infotainment**  
**Wire-wound Ferrite Inductors for Class D Amplifier LCXA for Automotive Body & Chassis and Infotainment**  
**Wire-wound Ferrite Power Inductors LCRN series for Automotive Body & Chassis and Infotainment**  
**Wire-wound Ferrite Power Inductors LBXN/LBXP series**  
**for Telecommunications Infrastructure and Industrial Equipment**  
**Wire-wound Ferrite Power Inductors LBXH series**  
**for Telecommunications Infrastructure and Industrial Equipment**  
**Wire-wound Ferrite Power Inductors LBRN series**  
**for Telecommunications Infrastructure and Industrial Equipment**  
**Wire-wound Ferrite Power Inductors LMXN/LMXP series**  
**for Medical Devices classified as GHTF Class C (Japan Class III)**  
**Wire-wound Ferrite Power Inductors LMXH series**  
**for Medical Devices classified as GHTF Class C (Japan Class III)**  
**Wire-wound Ferrite Power Inductors LMRN series**  
**for Medical Devices classified as GHTF Class C (Japan Class III)**

**■ PRECAUTIONS**

1. Circuit Design	
Precautions	<ul style="list-style-type: none"> <li>◆ Verification of operating environment, electrical rating and performance               <ol style="list-style-type: none"> <li>1. A malfunction in medical equipment, spacecraft, nuclear reactors, etc. may cause serious harm to human life or have severe social ramifications. As such, any inductors to be used in such equipment may require higher safety and/or reliability considerations and should be clearly differentiated from components used in general purpose applications.</li> <li>2. When inductors are used in places where dew condensation develops and/or where corrosive gas such as hydrogen sulfide, sulfurous acid, or chlorine exists in the air, characteristic deterioration may occur. Please do not use inductors under such environmental conditions.</li> </ol> </li> <li>◆ Operating Current (Verification of Rated current)               <ol style="list-style-type: none"> <li>1. The operating current including inrush current for inductors must always be lower than their rated values.</li> <li>2. Do not apply current in excess of the rated value because the inductance may be reduced due to the magnetic saturation effect.</li> </ol> </li> <li>◆ Temperature rise               <p style="margin-left: 20px;">Temperature rise of power choke coil depends on the installation condition in end products.</p> <p style="margin-left: 20px;">Make sure that temperature rise of power choke coils in actual end products is within the specified temperature range.</p> </li> </ul>
2. PCB Design	
Precautions	<ul style="list-style-type: none"> <li>◆ Land pattern design               <ol style="list-style-type: none"> <li>1. Please refer to a recommended land pattern.</li> <li>2. There is stress, which has been caused by distortion of a PCB, to the inductor. (LAXH/LCXN/LCXP/LBXN/LBXP/LMXN/LMXP, LCXH/LCXA/LBXH/LMXH)</li> <li>3. Please consider the arrangement of parts on a PCB. (LAXH/LCXN/LCXP/LBXN/LBXP/LMXN/LMXP, LCXH/LCXA/LBXH/LMXH)</li> </ol> </li> </ul>
Technical considerations	<ul style="list-style-type: none"> <li>◆ Land pattern design               <p>Surface Mounting</p> <ol style="list-style-type: none"> <li>1. Mounting and soldering conditions should be checked beforehand.</li> <li>2. Applicable soldering process to this products is reflow soldering only.</li> <li>3. Please use the recommended land pattern shown as below. Electrical characteristics and the mounting ability of the product are being considered in the recommended land pattern. If a PCB is designed with other dimensions, defective soldering and stress to a product may occur due to misalignment. The performance of the product may not be brought out. If an adopted land pattern is different from the recommended land pattern, stress to the product will increase. It may cause cracks or defective electrical characteristics of the product. Please conduct validation completely before studying adoption of this product and please judge the pros and cons of adoption of this product with taking on responsibility. (LAXH/LCXN/LCXP/LBXN/LBXP/LMXN/LMXP, LCXH/LCXA/LBXH/LMXH)</li> <li>4. As coefficients of thermal expansion between an inductor and a PCB differs, cracks may occur on a ferrite core when thermal stress is applied to them after mounting an inductor. (Please refer to the drawings below.) Please conduct validation completely before studying adoption of this product and please judge the pros and cons of adoption of this product with taking on responsibility. (LAXH/LCXN/LCXP/LBXN/LBXP/LMXN/LMXP, LCXH/LCXA/LBXH/LMXH)</li> </ol> </li> </ul>

▶ This catalog contains the typical specification only due to the limitation of space. When you consider the purchase of our products, please check our specification.  
 For details of each product (characteristics graph, reliability information, precautions for use, and so on), see our Web site (<http://www.ty-top.com/>)

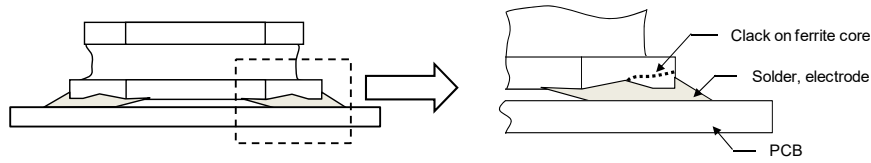

5. SMD inductors should be located to minimize any possible mechanical stresses from board warp or deflection. When splitting the PC board after mounting inductors and other components, care is required so as not to give any stresses of deflection or twisting to the board.

(LAXH/LCXN/LCXP/LBXN/LBXP/LMXN/LMXP, LCXH/LCXA/LBXH/LMXH)

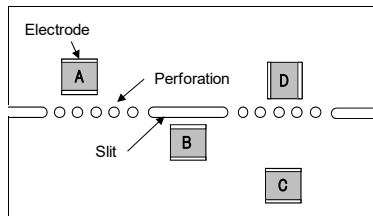

A product tends to undergo stress in order "A>C>B≡D". Please consider the layouts of a product to minimize any stresses.

### 3. Considerations for automatic placement

Precautions	<ul style="list-style-type: none"> <li>◆ Adjustment of mounting machine               <ol style="list-style-type: none"> <li>1. Excessive impact load should not be imposed on the products when mounting onto the PC boards.</li> <li>2. Mounting and soldering conditions should be checked beforehand.</li> </ol> </li> </ul>
Technical considerations	<ul style="list-style-type: none"> <li>◆ Adjustment of mounting machine               <ol style="list-style-type: none"> <li>1. When installing products, care should be taken not to apply distortion stress as it may deform the products.</li> <li>2. Stress may be applied to a product with a warp or a twist in handling of the product. Please conduct validation completely before studying adoption of this product and please judge the pros and cons of adoption of this product with taking on responsibility. (LAXH/LCXN/LCXP/LBXN/LBXP/LMXN/LMXP, LCXH/LCXA/LBXH/LMXH)</li> </ol> </li> </ul> <div style="display: flex; justify-content: space-around;"> <div style="text-align: center;"> <p>&lt;Wrap&gt;</p> </div> <div style="text-align: center;"> <p>&lt;Twist&gt;</p> </div> </div>

### 4. Soldering

Precautions	<ul style="list-style-type: none"> <li>◆ Reflow soldering               <ol style="list-style-type: none"> <li>1. Please contact any of our offices for a reflow soldering, and refer to the recommended condition specified.</li> <li>2. The product shall be used reflow soldering only.</li> <li>3. Please do not add any stress to a product until it returns in normal temperature after reflow soldering.</li> </ol> </li> <li>◆ Lead free soldering               <ol style="list-style-type: none"> <li>1. When using products with lead free soldering, we request to use them after confirming adhesion, temperature of resistance to soldering heat, soldering etc sufficiently.</li> </ol> </li> <li>◆ Recommended conditions for using a soldering iron(Repair)               <ul style="list-style-type: none"> <li>• Put the soldering iron on the land-pattern.</li> <li>• Soldering iron's temperature - Below 350°C</li> <li>• Duration - 3 seconds or less</li> <li>• The soldering iron should not directly touch the inductor.</li> </ul> </li> </ul>
Technical considerations	<ul style="list-style-type: none"> <li>◆ Reflow soldering               <ol style="list-style-type: none"> <li>1. If products are used beyond the range of the recommended conditions, heat stresses may deform the products, and consequently degrade the reliability of the products. Recommended reflow condition (Pb free solder) <u>LAXH/LCXN/LCXP/LBXN/LBXP/LMXN/LMXP,</u> <u>LCXH/LCXA/LBXH/LMXH, LCRN/LBRN/LMRN</u></li> </ol> </li> </ul> <div style="display: flex; justify-content: space-around;"> <div style="text-align: center;"> </div> <div style="text-align: center;"> </div> </div>

▶ This catalog contains the typical specification only due to the limitation of space. When you consider the purchase of our products, please check our specification. For details of each product (characteristics graph, reliability information, precautions for use, and so on), see our Web site (<http://www.ty-top.com/>)

5. Cleaning	
Precautions	<ul style="list-style-type: none"> <li>◆ Cleaning conditions</li> <li>1. Washing by supersonic waves shall be avoided.</li> </ul>
Technical considerations	<ul style="list-style-type: none"> <li>◆ Cleaning conditions</li> <li>1. If washed by supersonic waves, the products might be broken.</li> </ul>
6. Handling	
Precautions	<ul style="list-style-type: none"> <li>◆ Handling</li> <li>1. Keep the product away from all magnets and magnetic objects.</li> <li>◆ Breakaway PC boards (splitting along perforations)</li> <li>1. When splitting the PC board after mounting product, care should be taken not to give any stresses of deflection or twisting to the board.</li> <li>2. Board separation should not be done manually, but by using the appropriate devices.</li> <li>◆ Mechanical considerations</li> <li>1. Please do not give the product any excessive mechanical shocks.</li> <li>2. Please do not add any shock and power to a product in transportation.</li> <li>◆ Pick-up pressure</li> <li>1. Please do not push to add any pressure to a winding part. Please do not give any shock and push into a ferrite core exposure part.</li> <li>◆ Packing</li> <li>1. Please avoid accumulation of a packing box as much as possible.</li> </ul>
Technical considerations	<ul style="list-style-type: none"> <li>◆ Handling</li> <li>1. There is a case that a characteristic varies with magnetic influence.</li> <li>◆ Breakaway PC boards (splitting along perforations)</li> <li>1. The position of the product on PCBs shall be carefully considered to minimize the stress caused from splitting of the PCBs.</li> <li>◆ Mechanical considerations</li> <li>1. There is a case to be damaged by a mechanical shock.</li> <li>2. There is a case to be broken by the handling in transportation.</li> <li>◆ Pick-up pressure</li> <li>1. Damage and a characteristic can vary with an excessive shock or stress.</li> <li>◆ Packing</li> <li>1. If packing boxes are accumulated, that could cause a deformation on packing tapes or a damage on the products.</li> </ul>
7. Storage conditions	
Precautions	<ul style="list-style-type: none"> <li>◆ Storage</li> <li>1. To maintain the solderability of terminal electrodes and to keep the packing material in good condition, temperature and humidity in the storage area should be controlled. <ul style="list-style-type: none"> <li>▪ Storage conditions</li> <li>Ambient temperature : <math>-5\sim 40^{\circ}\text{C}</math></li> <li>Humidity : Below 70% RH</li> <li>▪ The recommended ambient temperature is below <math>30^{\circ}\text{C}</math>. Even under ideal storage conditions, solderability of products electrodes may decrease as time passes.</li> <li>For this reason, product should be used within 6 months from the time of delivery.</li> <li>In case of storage over 6 months, solderability shall be checked before actual usage.</li> </ul> </li> </ul>
Technical considerations	<ul style="list-style-type: none"> <li>◆ Storage</li> <li>1. Under a high temperature and humidity environment, problems such as reduced solderability caused by oxidation of terminal electrodes and deterioration of taping/packaging materials may take place.</li> </ul>

## 通信基础设施 / 工业设备用途 绕线型铁氧体系功率电感器 LBXH 系列

系列前的记号来自型号，用来区分产品的种类和特性等。

回流焊

■ 型号标示法

\*使用温度范围 : -40~125°C (包含产品本身发热)

L	B	X	H	F	6	0	6	0	Y	E	L	1	0	0	M	M	R
①	②	③	④	⑤	⑥	⑦	⑧										

## ①系列

代码 (1) (2) (3) (4)	
LBXH	通信基础设施 / 工业设备用途 绕线型铁氧体系功率电感器

## (1) 产品群

代码	
L	电感器

## (3) 类型

代码	
X	绕线型铁氧体系 鼓型

## (2) 范畴

代码	推荐设备	品质等级
B	通信基础设施 / 工业设备	2

## (4) 特效 / 特性

代码	
H	混合功率扼流

## ②特征

代码	特征
F	底面电极 (银×焊料) 对应充填物

## ⑤包装

代码	包装
T	卷盘带装
L	卷盘带装

## ③尺寸 (L×W)

代码	尺寸 (L×W) [mm]
3030	3.0×3.0
4040	4.0×4.0
5050	5.0×5.0
6060	6.0×6.0

## ⑥标称电感值

代码 (例)	标称电感值 [μH]
2R2	2.2
100	10
101	100

※R=小数点

## ④尺寸 (H)

代码	尺寸 (H) [mm]
QK	1.5
WK	2.0
WB	2.2
XK	3.0
XA	3.1
YE	4.5

## ⑦电感量公差

代码	电感量公差
M	±20%
N	±30%

## ⑧管理记号

■标准外型尺寸 / 标准数量

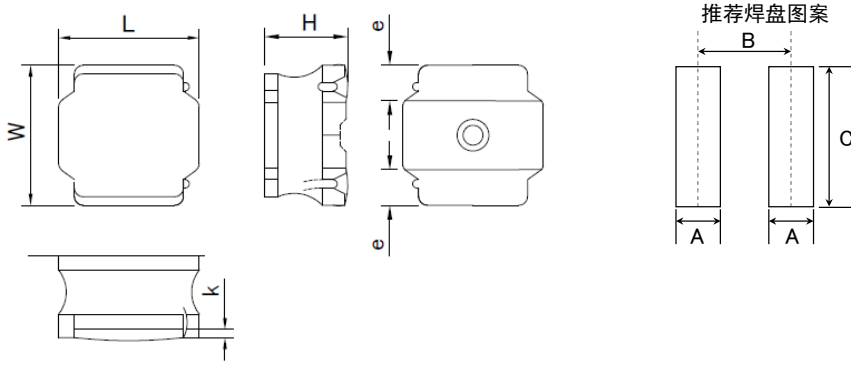

Type	A	B	C
3030	1.3	2.3	2.7
4040	1.5	3.3	3.5
5050	1.9	4.2	3.8
6060	2.4	5.0	4.8

单位: mm

Type	L	W	H	e	k(参考值)	标准数量 [pcs] 卷盘带装
3030QK	3.0±0.2 (0.118±0.008)	3.0±0.2 (0.118±0.008)	1.5 max (0.059 max)	0.8±0.3 (0.031±0.012)	0.1 min (0.004 min)	2000
4040WK	4.0±0.2 (0.158±0.008)	4.0±0.2 (0.158±0.008)	2.0 max (0.079 max)	1.0±0.3 (0.039±0.012)	0.1 min (0.004 min)	700
5050WB	5.0±0.2 (0.197±0.008)	5.0±0.2 (0.197±0.008)	2.2 max (0.088 max)	1.3±0.3 (0.051±0.012)	0.2 min (0.008 min)	800
5050XA	5.0±0.2 (0.197±0.008)	5.0±0.2 (0.197±0.008)	3.1 max (0.122 max)	1.3±0.3 (0.051±0.012)	0.2 min (0.008 min)	500
6060XK	6.0±0.2 (0.236±0.008)	6.0±0.2 (0.236±0.008)	3.0 max (0.118 max)	1.65±0.3 (0.053±0.012)	0.3 min (0.012 min)	2000

单位: mm (inch)

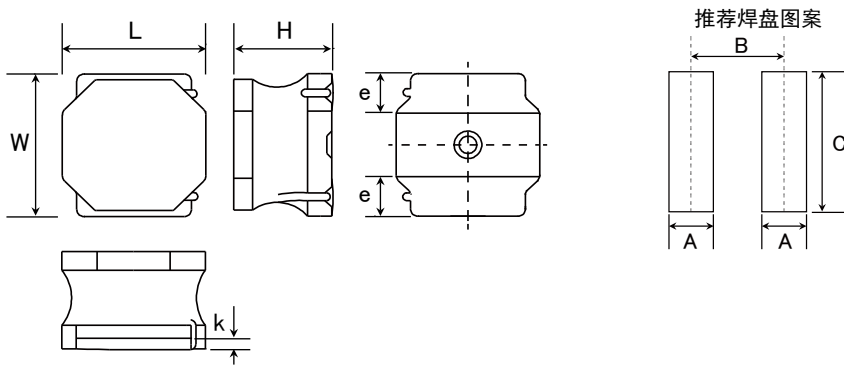

Type	A	B	C
6060	2.4	5.0	4.8

单位: mm

Type	L	W	H	e	k(参考值)	标准数量 [pcs] 卷盘带装
6060YE	6.0±0.2 (0.236±0.008)	6.0±0.2 (0.236±0.008)	4.5 max (0.177 max)	1.65±0.3 (0.053±0.012)	0.3 min (0.012 min)	1500

单位: mm (inch)

▶ 由于篇幅有限, 本产品目录中只记载了有代表性的产品规格, 若考虑使用敝公司产品时, 请确认交货规格说明书中的详细规格。  
另外, 有关各产品的详细信息(特性图、可靠性信息、使用时的注意事项等), 请参阅敝公司网站 (<http://www.ty-top.com/>)。

■ PART NUMBER

• All the Wire-wound Ferrite Power Inductors of the catalog lineup are RoHS compliant.

Notes)  
 • The exchange of individual specifications is necessary depending on your application and/or circuit condition. Please contact TAIYO YUDEN's official sales channel.  
 • The products are for Telecommunications infrastructure and Industrial equipment.  
 Please consult with TAIYO YUDEN's official sales channel for the details of the product specifications, etc., and please review and approve the product specifications before ordering.

● 3030QK type

New part number	Old part number (for reference)	Nominal inductance [μH]	Inductance tolerance	DC Resistance [mΩ] Max (Typ)	Rated current ※) [A]			Measuring frequency [MHz]
					Saturation current Idc1 Max (Typ)	Temperature rise current① Idc2 Max (Typ)	Temperature rise current② Idc2 Max (Typ)	
LBXHF3030QKT4R7MNR	NRM3015T R47MNR8	0.47	±20%	23 (18)	3.10 (4.50)	2.20 (2.60)	4.00 (4.55)	0.1
LBXHF3030QKT1R0MNR	NRM3015T 1R0MNR8	1	±20%	33 (28)	2.30 (3.20)	1.70 (2.10)	3.20 (3.60)	0.1
LBXHF3030QKT1R5MNR	NRM3015T 1R5MNR8	1.5	±20%	46 (38)	1.80 (2.25)	1.60 (2.00)	2.60 (2.95)	0.1
LBXHF3030QKT2R2MNR	NRM3015T 2R2MNR8	2.2	±20%	72 (60)	1.50 (1.90)	1.40 (1.80)	2.30 (2.60)	0.1
LBXHF3030QKT3R3MNR	NRM3015T 3R3MNR8	3.3	±20%	96 (80)	1.20 (1.63)	1.20 (1.60)	1.90 (2.20)	0.1
LBXHF3030QKT4R7MNR	NRM3015T 4R7MNR8	4.7	±20%	120 (100)	1.00 (1.40)	1.00 (1.40)	1.70 (1.90)	0.1
LBXHF3030QKT6R8MNR	NRM3015T 6R8MNR8	6.8	±20%	168 (140)	0.90 (1.15)	0.85 (1.20)	1.40 (1.60)	0.1
LBXHF3030QKT100MNR	NRM3015T 100MNR8	10	±20%	228 (190)	0.76 (0.91)	0.75 (1.00)	1.24 (1.40)	0.1
LBXHF3030QKT220MNR	NRM3015T 220MNR8	22	±20%	504 (420)	0.51 (0.66)	0.53 (0.70)	0.85 (0.95)	0.1
LBXHF3030QKT470MNR	NRM3015T 470MNR8	47	±20%	980 (820)	0.29 (0.39)	0.38 (0.50)	0.60 (0.65)	0.1
LBXHF3030QKT101MNR	NRM3015T 101MNR8	100	±20%	2028 (1690)	0.21 (0.27)	0.24 (0.33)	0.40 (0.45)	0.1

● 4040WK type

New part number	Old part number (for reference)	Nominal inductance [μH]	Inductance tolerance	DC Resistance [mΩ] Max (Typ)	Rated current ※) [A]			Measuring frequency [MHz]
					Saturation current Idc1 Max (Typ)	Temperature rise current① Idc2 Max (Typ)	Temperature rise current② Idc2 Max (Typ)	
LBXHF4040WKT1R0MNR	NRM4020T 1R0MNR8	1	±20%	31 (26)	4.60 (5.30)	2.43 (3.36)	3.66 (4.15)	0.1
LBXHF4040WKT2R2MNR	NRM4020T 2R2MNR8	2.2	±20%	52 (43)	3.00 (3.40)	1.91 (2.65)	3.00 (3.37)	0.1
LBXHF4040WKT4R7MNR	NRM4020T 4R7MNR8	4.7	±20%	84 (70)	2.00 (2.40)	1.50 (2.08)	2.27 (2.60)	0.1
LBXHF4040WKT100MNR	NRM4020T 100MNR8	10	±20%	156 (130)	1.50 (1.70)	1.05 (1.45)	1.63 (1.85)	0.1
LBXHF4040WKT220MNR	NRM4020T 220MNR8	22	±20%	360 (300)	1.00 (1.20)	0.71 (0.99)	1.09 (1.25)	0.1
LBXHF4040WKT470MNR	NRM4020T 470MNR8	47	±20%	660 (550)	0.70 (0.80)	0.53 (0.73)	0.80 (0.85)	0.1
LBXHF4040WKT101MNR	NRM4020T 101MNR8	100	±20%	1512 (1260)	0.46 (0.57)	0.34 (0.48)	0.53 (0.56)	0.1
LBXHF4040WKT221MNR	NRM4020T 221MNR8	220	±20%	3360 (2800)	0.33 (0.37)	0.23 (0.32)	0.36 (0.375)	0.1

● 5050WB type

New part number	Old part number (for reference)	Nominal inductance [μH]	Inductance tolerance	DC Resistance [mΩ] Max (Typ)	Rated current ※) [A]			Measuring frequency [MHz]
					Saturation current Idc1 Max (Typ)	Temperature rise current① Idc2 Max (Typ)	Temperature rise current② Idc2 Max (Typ)	
LBXHF5050WBTR47NMR	NRM5020T R47NMR8	0.47	±30%	14.4 (12)	6.60 (7.40)	3.60 (5.00)	6.00 (6.80)	0.1
LBXHF5050WBTR1R0NMR	NRM5020T 1R0NMR8	1	±30%	24 (20)	5.00 (5.50)	2.60 (3.60)	4.40 (4.90)	0.1
LBXHF5050WBTR1R5NMR	NRM5020T 1R5NMR8	1.5	±30%	32 (27)	4.00 (4.50)	2.40 (3.30)	4.00 (4.50)	0.1
LBXHF5050WBTR2R2NMR	NRM5020T 2R2NMR8	2.2	±30%	36 (30)	3.20 (3.60)	2.10 (2.90)	3.50 (4.00)	0.1
LBXHF5050WBTR3R3NMR	NRM5020T 3R3NMR8	3.3	±30%	49 (42)	2.50 (2.90)	1.90 (2.60)	3.10 (3.60)	0.1
LBXHF5050WBTR4R7MMR	NRM5020T 4R7MMR8	4.7	±20%	69.6 (58)	2.10 (2.40)	1.50 (2.10)	2.60 (2.90)	0.1
LBXHF5050WBTR100MMR	NRM5020T 100MMR8	10	±20%	127.2 (106)	1.50 (1.70)	1.10 (1.50)	1.80 (2.00)	0.1
LBXHF5050WBTR220MMR	NRM5020T 220MMR8	22	±20%	280 (230)	1.10 (1.20)	0.80 (1.10)	1.30 (1.50)	0.1
LBXHF5050WBTR470MMR	NRM5020T 470MMR8	47	±20%	520 (435)	0.73 (0.81)	0.58 (0.80)	0.97 (1.00)	0.1
LBXHF5050WBTR101MMR	NRM5020T 101MMR8	100	±20%	1020 (850)	0.50 (0.56)	0.42 (0.58)	0.69 (0.78)	0.1

● 5050XA type

New part number	Old part number (for reference)	Nominal inductance [μH]	Inductance tolerance	DC Resistance [mΩ] Max (Typ)	Rated current ※) [A]			Measuring frequency [MHz]
					Saturation current Idc1 Max (Typ)	Temperature rise current① Idc2 Max (Typ)	Temperature rise current② Idc2 Max (Typ)	
LBXHF5050XATR47NMR	NRM5030T R47NMR8	0.47	±30%	13 (10)	11.00 (12.00)	4.10 (5.50)	6.80 (7.70)	0.1
LBXHF5050XATR1R0NMR	NRM5030T 1R0NMR8	1	±30%	18.5 (14)	7.50 (8.00)	3.10 (4.30)	5.10 (5.80)	0.1
LBXHF5050XATR1R5NMR	NRM5030T 1R5NMR8	1.5	±30%	21.6 (18)	6.30 (6.80)	2.80 (3.70)	4.50 (5.10)	0.1
LBXHF5050XATR2R2NMR	NRM5030T 2R2NMR8	2.2	±30%	29 (24)	5.10 (5.60)	2.50 (3.40)	4.00 (4.60)	0.1
LBXHF5050XATR3R3NMR	NRM5030T 3R3NMR8	3.3	±30%	37 (32)	4.30 (4.80)	2.10 (2.90)	3.50 (3.90)	0.1
LBXHF5050XATR4R7MMR	NRM5030T 4R7MMR8	4.7	±20%	52 (43)	3.50 (3.90)	1.90 (2.50)	3.00 (3.40)	0.1
LBXHF5050XATR6R8MMR	NRM5030T 6R8MMR8	6.8	±20%	78 (65)	3.00 (3.40)	1.35 (1.95)	2.25 (2.50)	0.1
LBXHF5050XATR100MMR	NRM5030T 100MMR8	10	±20%	115 (96)	2.50 (2.75)	1.10 (1.60)	1.90 (2.10)	0.1
LBXHF5050XATR220MMR	NRM5030T 220MMR8	22	±20%	228 (190)	1.70 (1.90)	0.80 (1.10)	1.30 (1.50)	0.1
LBXHF5050XATR470MMR	NRM5030T 470MMR8	47	±20%	360 (300)	0.85 (1.00)	0.60 (0.85)	1.00 (1.20)	0.1
LBXHF5050XATR101MMR	NRM5030T 101MMR8	100	±20%	733 (611)	0.55 (0.60)	0.45 (0.60)	0.70 (0.80)	0.1
LBXHF5050XATR221MMR	NRM5030T 221MMR8	220	±20%	1692 (1412)	0.38 (0.41)	0.28 (0.38)	0.46 (0.53)	0.1
LBXHF5050XATR471MMR	NRM5030T 471MMR8	470	±20%	3672 (3060)	0.25 (0.28)	0.17 (0.24)	0.30 (0.35)	0.1

※) The saturation current value (Idc1) is the DC current value having inductance decrease down to 30%. (at 20°C)  
 ※) The temperature rise current value (Idc2)① is the DC current value having temperature increase up to 20°C. (at 20°C)  
 ※) The temperature rise current value (Idc2)② is the DC current value having temperature increase up to 40°C. (at 20°C)  
 ※) The rated current is the DC current value that satisfies both of current value saturation current value and temperature rise current value.

▶ 由于篇幅有限，本产品目录中只记载了有代表性的产品规格，若考虑使用敝公司产品时，请确认交货规格说明书中的详细规格。另外，有关各产品的详细信息（特性图、可靠性信息、使用时的注意事项等），请参阅敝公司网站（http://www.ty-top.com/）。

■ PART NUMBER

● 6060XK type

New part number	Old part number (for reference)	Nominal inductance [ $\mu$ H]	Inductance tolerance	DC Resistance [m $\Omega$ ] Max (Typ)	Rated current ※) [A]			Measuring frequency [MHz]
					Saturation current Idc1 Max (Typ)	Temperature rise current① Idc2 Max (Typ)	Temperature rise current② Idc2 Max (Typ)	
LBXHF6060XKL1R0NMR	NRM6030T 1R0NMRR8	1	±30%	17 (14)	7.50 (8.10)	3.40 (4.90)	5.80 (6.60)	0.1
LBXHF6060XKL2R2NMR	NRM6030T 2R2NMRR8	2.2	±30%	24 (20)	4.80 (6.00)	2.90 (4.00)	4.70 (5.40)	0.1
LBXHF6060XKL4R7MMR	NRM6030T 4R7MMRR8	4.7	±20%	36 (30)	3.30 (3.80)	2.30 (3.30)	3.80 (4.40)	0.1
LBXHF6060XKL100MMR	NRM6030T 100MMRR8	10	±20%	72 (60)	2.20 (2.60)	1.60 (2.25)	2.70 (3.10)	0.1
LBXHF6060XKL220MMR	NRM6030T 220MMRR8	22	±20%	150 (125)	1.50 (1.80)	1.10 (1.60)	1.90 (2.20)	0.1
LBXHF6060XKL470MMR	NRM6030T 470MMRR8	47	±20%	320 (270)	1.00 (1.20)	0.76 (1.10)	1.27 (1.48)	0.1
LBXHF6060XKL101MMR	NRM6030T 101MMRR8	100	±20%	660 (550)	0.73 (0.85)	0.53 (0.74)	0.88 (0.99)	0.1

● 6060YE type

New part number	Old part number (for reference)	Nominal inductance [ $\mu$ H]	Inductance tolerance	DC Resistance [m $\Omega$ ] Max (Typ)	Rated current ※) [A]			Measuring frequency [MHz]
					Saturation current Idc1 Max (Typ)	Temperature rise current① Idc2 Max (Typ)	Temperature rise current② Idc2 Max (Typ)	
LBXHF6060YEL1R0NMR	NRM6045T 1R0NMRR8	1	±30%	13 (10)	13.50 (14.50)	4.00 (6.00)	6.20 (7.00)	0.1
LBXHF6060YEL1R5NMR	NRM6045T 1R5NMRR8	1.5	±30%	19 (14)	10.00 (11.00)	3.40 (4.70)	5.50 (6.40)	0.1
LBXHF6060YEL2R2NMR	NRM6045T 2R2NMRR8	2.2	±30%	23 (18)	8.50 (9.50)	3.00 (4.00)	4.40 (5.10)	0.1
LBXHF6060YEL3R3MMR	NRM6045T 3R3MMRR8	3.3	±20%	27.6(23)	7.00 (7.50)	2.50 (3.50)	4.00 (4.50)	0.1
LBXHF6060YEL4R7MMR	NRM6045T 4R7MMRR8	4.7	±20%	36 (30)	6.00 (6.50)	2.20 (3.00)	3.60 (3.90)	0.1
LBXHF6060YEL6R8MMR	NRM6045T 6R8MMRR8	6.8	±20%	52 (43)	5.10 (5.60)	1.90 (2.60)	3.10 (3.50)	0.1
LBXHF6060YEL100MMR	NRM6045T 100MMRR8	10	±20%	60 (50)	4.00 (4.40)	1.80 (2.40)	2.60 (3.20)	0.1
LBXHF6060YEL150MMR	NRM6045T 150MMRR8	15	±20%	105 (87)	3.10 (3.50)	1.40 (1.80)	2.15 (2.45)	0.1
LBXHF6060YEL220MMR	NRM6045T 220MMRR8	22	±20%	132 (110)	2.50 (3.00)	1.20 (1.60)	1.80 (2.00)	0.1
LBXHF6060YEL330MMR	NRM6045T 330MMRR8	33	±20%	216 (180)	1.75 (1.95)	0.75 (0.95)	1.25 (1.35)	0.1
LBXHF6060YEL470MMR	NRM6045T 470MMRR8	47	±20%	272 (227)	1.55 (1.70)	0.70 (0.90)	1.20 (1.30)	0.1
LBXHF6060YEL680MMR	NRM6045T 680MMRR8	68	±20%	385 (320)	1.20 (1.30)	0.65 (0.85)	1.05 (1.20)	0.1
LBXHF6060YEL101MMR	NRM6045T 101MMRR8	100	±20%	600 (475)	1.05 (1.15)	0.55 (0.70)	0.85 (0.95)	0.1
LBXHF6060YEL151MMR	NRM6045T 151MMRR8	150	±20%	816 (680)	0.83 (0.90)	0.48 (0.65)	0.76 (0.85)	0.1
LBXHF6060YEL221MMR	NRM6045T 221MMRR8	220	±20%	1320 (1100)	0.70 (0.75)	0.35 (0.50)	0.57 (0.65)	0.1
LBXHF6060YEL331MMR	NRM6045T 331MMRR8	330	±20%	1872 (1580)	0.55 (0.60)	0.29 (0.39)	0.45 (0.54)	0.1
LBXHF6060YEL471MMR	NRM6045T 471MMRR8	470	±20%	2760 (2300)	0.45 (0.50)	0.22 (0.30)	0.38 (0.45)	0.1

- ※) The saturation current value (Idc1) is the DC current value having inductance decrease down to 30%. (at 20°C)
- ※) The temperature rise current value (Idc2)① is the DC current value having temperature increase up to 20°C. (at 20°C)
- ※) The temperature rise current value (Idc2)② is the DC current value having temperature increase up to 40°C. (at 20°C)
- ※) The rated current is the DC current value that satisfies both of current value saturation current value and temperature rise current value.

■ Derating of Rated Current

● LBXH series

Derating of current is necessary for LBXH series depending on ambient temperature. Please refer to the chart shown below for appropriate derating of current.

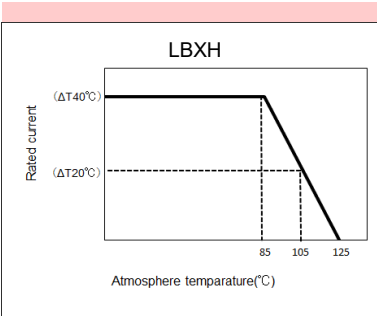

▶ 由于篇幅有限，本产品目录中只记载了有代表性的产品规格，若考虑使用敝公司产品时，请确认交货规格说明书中的详细规格。另外，有关各产品的详细信息（特性图、可靠性信息、使用时的注意事项等），请参阅敝公司网站（<http://www.ty-top.com/>）。



Wire-wound Ferrite Power Inductors LSXN/LSXP/LCXN/LCXP/LBXN/LBXP/  
 LLXN/LLXP/LMXN/LMXP series  
 Wire-wound Ferrite Power Inductors LAXH/LCXH/LBXH/LMXH series  
 Wire-wound Ferrite Inductors for Class D Amplifier LCXA

■ PACKAGING

① Minimum Quantity

Type	Standard Quantity [pcs]
	Tape & Reel
2020KK	2500
2020MK	2500
2424KK	2500
2424MK	2500
3030KK	2000
3030MK	2000
3030QK	2000
4040KK	5000
4040MK	4500
4040TK	3500
4040WK	700

Type	Standard Quantity [pcs]
	Tape & Reel
5050KK	1000
5050MK	1000
5050PK	1000
5050WB	800
5050WK	800
5050WD	2500
5050WE	2500
5050XK	500
5050XA	500
5050YA	1500
5050YK	1500
6060KK	1000
6060MK	1000
6060PK	1000
6060WK	2500
6060WH	2000
6060XK	2000
6060YE	1500
8080XK	1000
8080YK	1000
8080YB	1000

② Tape Material

● Embossed Tape

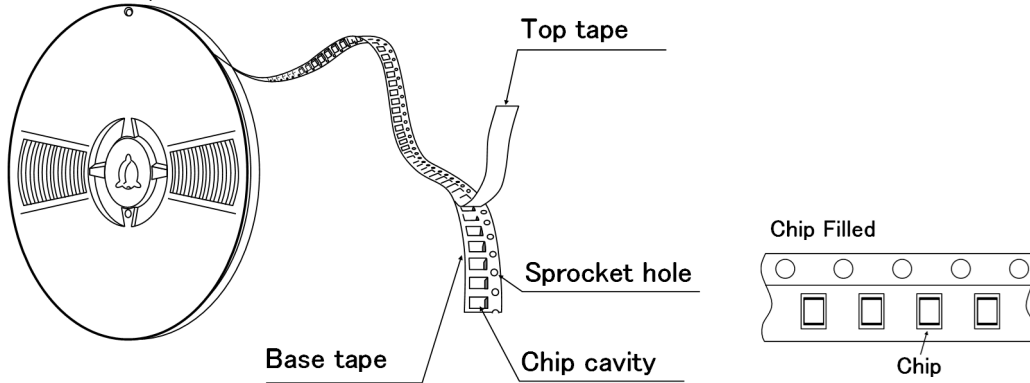

③ Taping dimensions

● Embossed tape 8mm wide (0.315 inches wide)

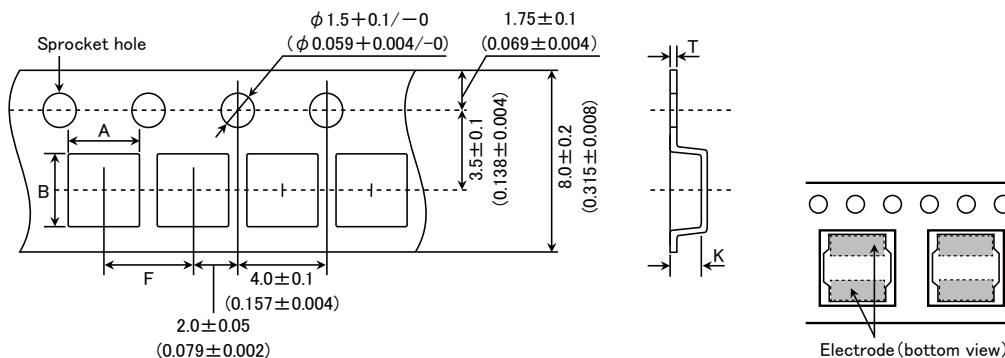

▶ This catalog contains the typical specification only due to the limitation of space. When you consider the purchase of our products, please check our specification. For details of each product (characteristics graph, reliability information, precautions for use, and so on), see our Web site (<http://www.ty-top.com/>).

Type	Chip cavity		Insertion pitch F	Tape thickness	
	A	B		T	K
2020KK 2020MK	2.2±0.1 (0.102±0.004)	2.2±0.1 (0.102±0.004)	4.0±0.1 (0.157±0.004)	0.25±0.05 (0.009±0.002)	1.3±0.1 (0.051±0.004)
2424KK 2424MK	2.6±0.1 (0.087±0.004)	2.6±0.1 (0.102±0.004)		0.25±0.05 (0.009±0.002)	1.3±0.1 (0.051±0.004)
3030KK	3.2±0.1 (0.126±0.004)	3.2±0.1 (0.126±0.004)		0.3±0.05 (0.012±0.002)	1.4±0.1 (0.055±0.004)
3030MK					1.6±0.1 (0.063±0.004)
3030QK					1.9±0.1 (0.075±0.004)

Unit: mm (inch)

● Embossed tape 12mm wide (0.47 inches wide)

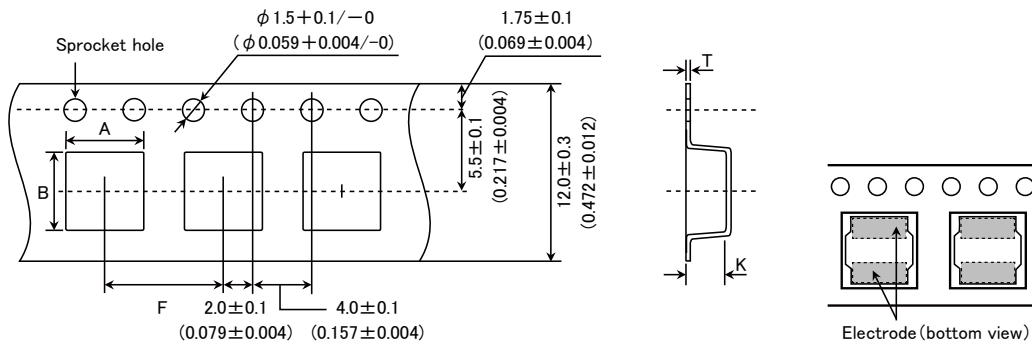

Type	Chip cavity		Insertion pitch F	Tape thickness		
	A	B		T	K	
4040KK	4.3±0.1 (0.169±0.004)	4.3±0.1 (0.169±0.004)	8.0±0.1 (0.315±0.004)	0.3±0.1 (0.012±0.004)	1.4±0.1 (0.055±0.004)	
4040MK					1.6±0.1 (0.063±0.004)	
4040TK 4040WK					2.1±0.1 (0.083±0.004)	
5050KK	5.25±0.1 (0.207±0.004)	5.25±0.1 (0.207±0.004)			1.4±0.1 (0.055±0.004)	
5050MK						1.4±0.1 (0.055±0.004)
5050PK						1.6±0.1 (0.063±0.004)
5050WB 5050WK				2.3±0.1 (0.091±0.004)		
5050WD 5050WE				2.7±0.1 (0.106±0.004)		
5050XK 5050XA				5.15±0.1 (0.203±0.004)		5.15±0.1 (0.203±0.004)
5050YK 5050YA	5.15±0.1 (0.203±0.004)	5.15±0.1 (0.203±0.004)		4.2±0.1 (0.165±0.004)		
6060KK	6.3±0.1 (0.248±0.004)	6.3±0.1 (0.248±0.004)		0.4±0.1 (0.016±0.004)	1.4±0.1 (0.055±0.004)	
6060MK					1.6±0.1 (0.063±0.004)	
6060PK			1.6±0.1 (0.063±0.004)			
6060WK			2.3±0.1 (0.090±0.004)			
6060WH 6060XK			3.1±0.1 (0.122±0.004)			
6060YE			4.7±0.1 (0.185±0.004)			

Unit: mm (inch)

► This catalog contains the typical specification only due to the limitation of space. When you consider the purchase of our products, please check our specification. For details of each product (characteristics graph, reliability information, precautions for use, and so on), see our Web site (<http://www.ty-top.com/>).

● Embossed tape 16mm wide (0.63 inches wide)

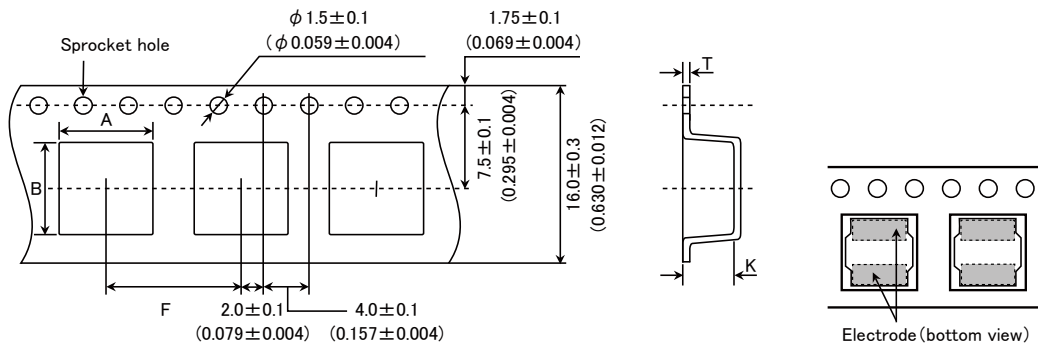

Type	Chip cavity		Insertion pitch F	Tape thickness	
	A	B		T	K
8080XK	$8.3 \pm 0.1$ ( $0.327 \pm 0.004$ )	$8.3 \pm 0.1$ ( $0.327 \pm 0.004$ )	$12.0 \pm 0.1$ ( $0.472 \pm 0.004$ )	$0.5 \pm 0.1$ ( $0.020 \pm 0.004$ )	$3.4 \pm 0.1$ ( $0.134 \pm 0.004$ )
8080YK					$4.5 \pm 0.1$ ( $0.177 \pm 0.004$ )
8080YB					$4.5 \pm 0.1$ ( $0.177 \pm 0.004$ )

Unit: mm (inch)

④ Leader and Blank portion

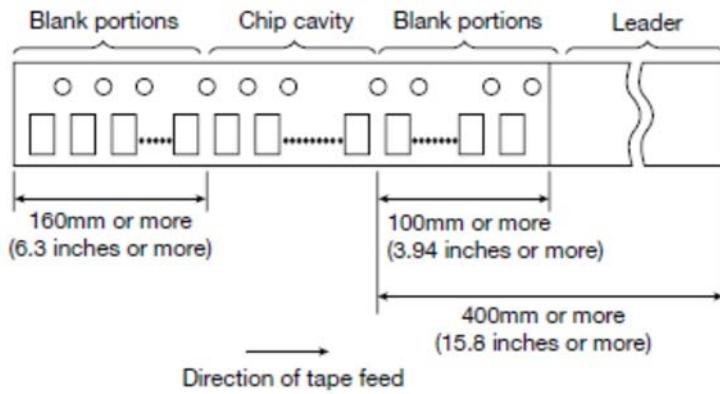

⑤ Reel size

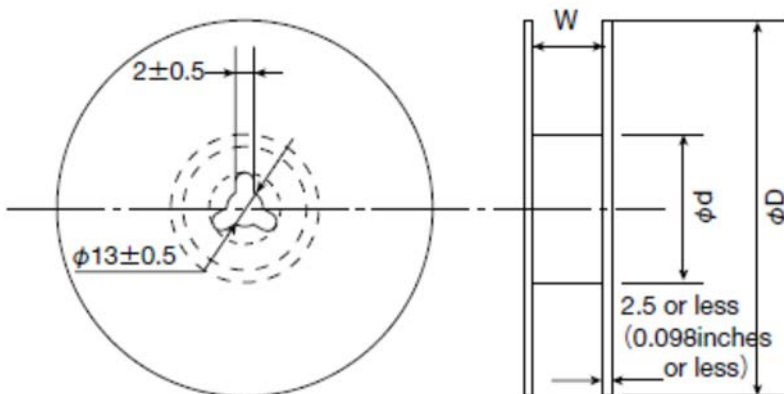

► This catalog contains the typical specification only due to the limitation of space. When you consider the purchase of our products, please check our specification. For details of each product (characteristics graph, reliability information, precautions for use, and so on), see our Web site (<http://www.ty-top.com/>).

Type	Reel size (Reference values)		
	$\phi D$	$\phi d$	W
2020KK	180±0.5 (7.087±0.019)	60±1.0 (2.36±0.04)	10.0±1.5 (0.394±0.059)
2020MK			
2424KK			
2424MK			
3030KK			
3030MK			
3030QK			
4040WK	180±3.0 (7.087±0.118)	60±2.0 (2.36±0.08)	14.0±1.5 (0.551±0.059)
5050KK			
5050MK			
5050PK			
5050WB			
5050WK			
5050XK			
5050XA			
6060KK			
6060MK			
6060PK			

Unit: mm (inch)

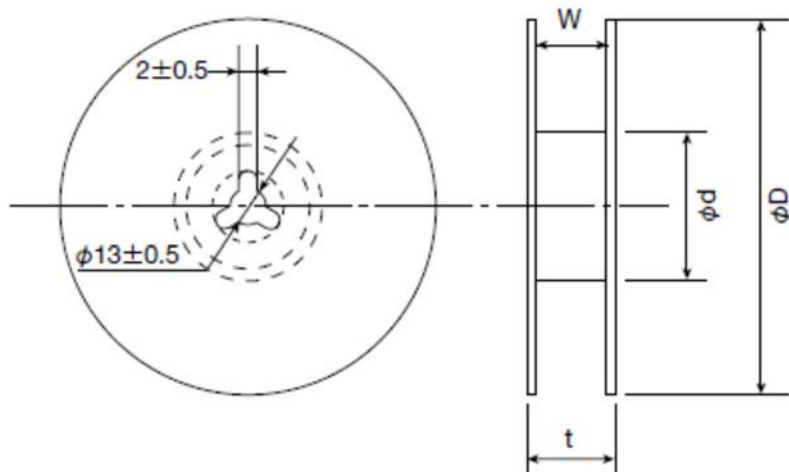

Type	Reel size (Reference values)			
	$\phi D$	$\phi d$	t (max.)	W
4040KK	330±3.0 (12.99±0.118)	80±2.0 (3.15±0.078)	18.5 (0.72)	13.5±1.0 (0.531±0.04)
4040MK				
4040TK				
5050WD				
5050WE				
5050YA				
5050YK				
6060WK				
6060WH				
6060XK				
6060YE				
8080XK			22.5 (0.89)	17.5±1.0 (0.689±0.04)
8080YK				
8080YB				
8080YB				

Unit: mm (inch)

### ⑥ Top Tape Strength

The top tape requires a peel-off force of 0.1 to 1.3N in the direction of the arrow as illustrated below.

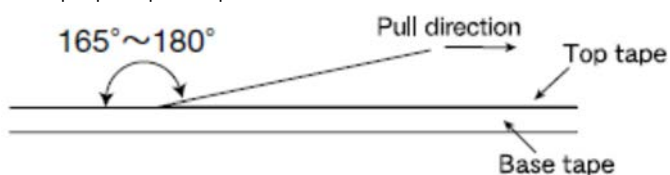

**Wire-wound Ferrite Power Inductors LBXH series  
for Telecommunications Infrastructure and Industrial Equipment**  
**Wire-wound Ferrite Power Inductors LMXH series  
for Medical Devices classified as GHTF Class C (Japan Class III)**

■ RELIABILITY DATA

1. Operating Temperature Range

Specified Value     −40~ +125°C (Including self-generated heat)

Test Methods and Remarks     Including self-generated heat

2. Storage Temperature Range

Specified Value     −40~ +125°C

Test Methods and Remarks     −5 to 40°C for the product with taping.

3. Rated current

Specified Value     Within the specified tolerance

4. Inductance

Specified Value     Within the specified tolerance

Test Methods and Remarks     Measuring equipment     : LCR Meter (HP 4285A or equivalent)  
   Measuring frequency     : 100kHz, 1V

5. DC Resistance

Specified Value     Within the specified tolerance

Test Methods and Remarks     Measuring equipment     : DC ohmmeter (HIOKI 3227 or equivalent)

6. Temperature characteristic

Specified Value     Inductance change : Within ±20%

Test Methods and Remarks     Measurement of inductance shall be taken at temperature range within −40°C~ +125°C.  
   With reference to inductance value at +20°C., change rate shall be calculated.  
   Change of maximum inductance deviation in step 1 to 5

Step	Temperature (°C)
1	20
2	Minimum operating temperature
3	20 (Standard temperature)
4	Maximum operating temperature
5	20

▶ This catalog contains the typical specification only due to the limitation of space. When you consider the purchase of our products, please check our specification.  
 For details of each product (characteristics graph, reliability information, precautions for use, and so on), see our Web site (<http://www.ty-top.com/>).



## 12. Thermal shock

Specified Value	Inductance change : Within $\pm 10\%$ No significant abnormality in appearance.																		
Test Methods and Remarks	The test samples shall be soldered to the test board by the reflow. The test samples shall be placed at specified temperature for specified time by step 1 to step 4 as shown in below table in sequence. The temperature cycle shall be repeated 1000 cycles. <table border="1" style="margin-left: 20px;"> <thead> <tr> <th colspan="3">Conditions of 1 cycle</th> </tr> <tr> <th>段階</th> <th>Temperature (<math>^{\circ}\text{C}</math>)</th> <th>Duration (min)</th> </tr> </thead> <tbody> <tr> <td>1</td> <td><math>-40 \pm 3</math></td> <td><math>30 \pm 3</math></td> </tr> <tr> <td>2</td> <td>Room temperature</td> <td>Within 3</td> </tr> <tr> <td>3</td> <td><math>+105 \pm 3</math></td> <td><math>30 \pm 3</math></td> </tr> <tr> <td>4</td> <td>Room temperature</td> <td>Within 3</td> </tr> </tbody> </table>	Conditions of 1 cycle			段階	Temperature ( $^{\circ}\text{C}$ )	Duration (min)	1	$-40 \pm 3$	$30 \pm 3$	2	Room temperature	Within 3	3	$+105 \pm 3$	$30 \pm 3$	4	Room temperature	Within 3
Conditions of 1 cycle																			
段階	Temperature ( $^{\circ}\text{C}$ )	Duration (min)																	
1	$-40 \pm 3$	$30 \pm 3$																	
2	Room temperature	Within 3																	
3	$+105 \pm 3$	$30 \pm 3$																	
4	Room temperature	Within 3																	

## 13. Damp heat

Specified Value	Inductance change : Within $\pm 10\%$ No significant abnormality in appearance.						
Test Methods and Remarks	The test samples shall be soldered to the test board by the reflow. The test samples shall be placed in thermostatic oven set at specified temperature and humidity as shown in below table. <table border="1" style="margin-left: 20px;"> <tbody> <tr> <td>Temperature</td> <td><math>85 \pm 2^{\circ}\text{C}</math></td> </tr> <tr> <td>Humidity</td> <td>85%RH</td> </tr> <tr> <td>Time</td> <td>1000 + 24 / - 0 hour</td> </tr> </tbody> </table>	Temperature	$85 \pm 2^{\circ}\text{C}$	Humidity	85%RH	Time	1000 + 24 / - 0 hour
Temperature	$85 \pm 2^{\circ}\text{C}$						
Humidity	85%RH						
Time	1000 + 24 / - 0 hour						

## 14. Low temperature life test

Specified Value	Inductance change : Within $\pm 10\%$ No significant abnormality in appearance.				
Test Methods and Remarks	The test samples shall be soldered to the test board by the reflow. After that, the test samples shall be placed at test conditions as shown in below table. <table border="1" style="margin-left: 20px;"> <tbody> <tr> <td>Temperature</td> <td><math>-40 \pm 2^{\circ}\text{C}</math></td> </tr> <tr> <td>Time</td> <td>1000 + 24 / - 0 hour</td> </tr> </tbody> </table>	Temperature	$-40 \pm 2^{\circ}\text{C}$	Time	1000 + 24 / - 0 hour
Temperature	$-40 \pm 2^{\circ}\text{C}$				
Time	1000 + 24 / - 0 hour				

## 15. High temperature life test

Specified Value	Inductance change : Within $\pm 10\%$ No significant abnormality in appearance.				
Test Methods and Remarks	The test samples shall be soldered to the test board by the reflow. After that, the test samples shall be placed at test conditions as shown in below table. <table border="1" style="margin-left: 20px;"> <tbody> <tr> <td>Temperature</td> <td><math>125 \pm 3^{\circ}\text{C}</math></td> </tr> <tr> <td>Time</td> <td>1000 hour</td> </tr> </tbody> </table>	Temperature	$125 \pm 3^{\circ}\text{C}$	Time	1000 hour
Temperature	$125 \pm 3^{\circ}\text{C}$				
Time	1000 hour				

## 16. Loading at high temperature life test

Specified Value	Inductance change : Within $\pm 10\%$ No significant abnormality in appearance.						
Test Methods and Remarks	The test samples shall be soldered to the test board by the reflow soldering. <table border="1" style="margin-left: 20px;"> <tbody> <tr> <td>Temperature</td> <td>1) <math>85 \pm 2^{\circ}\text{C}</math> 2) <math>105 \pm 3^{\circ}\text{C}</math></td> </tr> <tr> <td>Applied current</td> <td>1) Rated current (<math>+40^{\circ}\text{C}</math>) 2) Rated current (<math>+20^{\circ}\text{C}</math>)</td> </tr> <tr> <td>Time</td> <td>1000 + 24 / - 0 hour</td> </tr> </tbody> </table>	Temperature	1) $85 \pm 2^{\circ}\text{C}$ 2) $105 \pm 3^{\circ}\text{C}$	Applied current	1) Rated current ( $+40^{\circ}\text{C}$ ) 2) Rated current ( $+20^{\circ}\text{C}$ )	Time	1000 + 24 / - 0 hour
Temperature	1) $85 \pm 2^{\circ}\text{C}$ 2) $105 \pm 3^{\circ}\text{C}$						
Applied current	1) Rated current ( $+40^{\circ}\text{C}$ ) 2) Rated current ( $+20^{\circ}\text{C}$ )						
Time	1000 + 24 / - 0 hour						

## 17. Standard condition

Specified Value	Standard test condition : Unless otherwise specified, temperature is $20 \pm 15^{\circ}\text{C}$ and $65 \pm 20\%$ of relative humidity. When there is any question concerning measurement result: In order to provide correlation data, the test shall be condition of $20 \pm 2^{\circ}\text{C}$ of temperature, $65 \pm 5\%$ relative humidity. Inductance is in accordance with our measured value.
-----------------	--

**Wire-wound Ferrite Power Inductors LAYP series for Automotive Powertrain and safety**  
**Wire-wound Ferrite Power Inductors LAXH series for Automotive Powertrain and safety**  
**Wire-wound Ferrite Power Inductors LCXN/LCXP series for Automotive Body & Chassis and Infotainment**  
**Wire-wound Ferrite Power Inductors LCXH series for Automotive Body & Chassis and Infotainment**  
**Wire-wound Ferrite Inductors for Class D Amplifier LCXA for Automotive Body & Chassis and Infotainment**  
**Wire-wound Ferrite Power Inductors LCRN series for Automotive Body & Chassis and Infotainment**  
**Wire-wound Ferrite Power Inductors LBXN/LBXP series**  
**for Telecommunications Infrastructure and Industrial Equipment**  
**Wire-wound Ferrite Power Inductors LBXH series**  
**for Telecommunications Infrastructure and Industrial Equipment**  
**Wire-wound Ferrite Power Inductors LBRN series**  
**for Telecommunications Infrastructure and Industrial Equipment**  
**Wire-wound Ferrite Power Inductors LMXN/LMXP series**  
**for Medical Devices classified as GHTF Class C (Japan Class III)**  
**Wire-wound Ferrite Power Inductors LMXH series**  
**for Medical Devices classified as GHTF Class C (Japan Class III)**  
**Wire-wound Ferrite Power Inductors LMRN series**  
**for Medical Devices classified as GHTF Class C (Japan Class III)**

**■ PRECAUTIONS**

1. Circuit Design	
Precautions	<ul style="list-style-type: none"> <li>◆ Verification of operating environment, electrical rating and performance               <ol style="list-style-type: none"> <li>1. A malfunction in medical equipment, spacecraft, nuclear reactors, etc. may cause serious harm to human life or have severe social ramifications. As such, any inductors to be used in such equipment may require higher safety and/or reliability considerations and should be clearly differentiated from components used in general purpose applications.</li> <li>2. When inductors are used in places where dew condensation develops and/or where corrosive gas such as hydrogen sulfide, sulfurous acid, or chlorine exists in the air, characteristic deterioration may occur. Please do not use inductors under such environmental conditions.</li> </ol> </li> <li>◆ Operating Current (Verification of Rated current)               <ol style="list-style-type: none"> <li>1. The operating current including inrush current for inductors must always be lower than their rated values.</li> <li>2. Do not apply current in excess of the rated value because the inductance may be reduced due to the magnetic saturation effect.</li> </ol> </li> <li>◆ Temperature rise               <p style="margin-left: 20px;">Temperature rise of power choke coil depends on the installation condition in end products.</p> <p style="margin-left: 20px;">Make sure that temperature rise of power choke coils in actual end products is within the specified temperature range.</p> </li> </ul>
2. PCB Design	
Precautions	<ul style="list-style-type: none"> <li>◆ Land pattern design               <ol style="list-style-type: none"> <li>1. Please refer to a recommended land pattern.</li> <li>2. There is stress, which has been caused by distortion of a PCB, to the inductor. (LAXH/LCXN/LCXP/LBXN/LBXP/LMXN/LMXP, LCXH/LCXA/LBXH/LMXH)</li> <li>3. Please consider the arrangement of parts on a PCB. (LAXH/LCXN/LCXP/LBXN/LBXP/LMXN/LMXP, LCXH/LCXA/LBXH/LMXH)</li> </ol> </li> </ul>
Technical considerations	<ul style="list-style-type: none"> <li>◆ Land pattern design               <p>Surface Mounting</p> <ol style="list-style-type: none"> <li>1. Mounting and soldering conditions should be checked beforehand.</li> <li>2. Applicable soldering process to this products is reflow soldering only.</li> <li>3. Please use the recommended land pattern shown as below. Electrical characteristics and the mounting ability of the product are being considered in the recommended land pattern. If a PCB is designed with other dimensions, defective soldering and stress to a product may occur due to misalignment. The performance of the product may not be brought out. If an adopted land pattern is different from the recommended land pattern, stress to the product will increase. It may cause cracks or defective electrical characteristics of the product. Please conduct validation completely before studying adoption of this product and please judge the pros and cons of adoption of this product with taking on responsibility. (LAXH/LCXN/LCXP/LBXN/LBXP/LMXN/LMXP, LCXH/LCXA/LBXH/LMXH)</li> <li>4. As coefficients of thermal expansion between an inductor and a PCB differs, cracks may occur on a ferrite core when thermal stress is applied to them after mounting an inductor. (Please refer to the drawings below.) Please conduct validation completely before studying adoption of this product and please judge the pros and cons of adoption of this product with taking on responsibility. (LAXH/LCXN/LCXP/LBXN/LBXP/LMXN/LMXP, LCXH/LCXA/LBXH/LMXH)</li> </ol> </li> </ul>

▶ This catalog contains the typical specification only due to the limitation of space. When you consider the purchase of our products, please check our specification.  
 For details of each product (characteristics graph, reliability information, precautions for use, and so on), see our Web site (<http://www.ty-top.com/>)



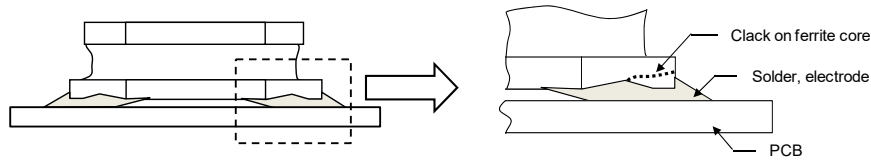

5. SMD inductors should be located to minimize any possible mechanical stresses from board warp or deflection. When splitting the PC board after mounting inductors and other components, care is required so as not to give any stresses of deflection or twisting to the board.

(LAXH/LCXN/LCXP/LBXN/LBXP/LMXN/LMXP, LCXH/LCXA/LBXH/LMXH)

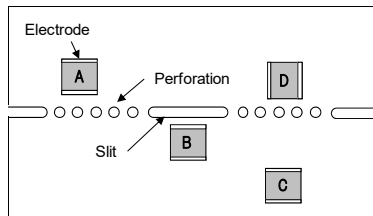

A product tends to undergo stress in order "A>C>B≡D". Please consider the layouts of a product to minimize any stresses.

### 3. Considerations for automatic placement

Precautions	<ul style="list-style-type: none"> <li>◆ Adjustment of mounting machine             <ol style="list-style-type: none"> <li>1. Excessive impact load should not be imposed on the products when mounting onto the PC boards.</li> <li>2. Mounting and soldering conditions should be checked beforehand.</li> </ol> </li> </ul>
Technical considerations	<ul style="list-style-type: none"> <li>◆ Adjustment of mounting machine             <ol style="list-style-type: none"> <li>1. When installing products, care should be taken not to apply distortion stress as it may deform the products.</li> <li>2. Stress may be applied to a product with a warp or a twist in handling of the product. Please conduct validation completely before studying adoption of this product and please judge the pros and cons of adoption of this product with taking on responsibility. (LAXH/LCXN/LCXP/LBXN/LBXP/LMXN/LMXP, LCXH/LCXA/LBXH/LMXH)</li> </ol> </li> </ul> <div style="display: flex; justify-content: space-around;"> <div style="text-align: center;"> <p>&lt;Wrap&gt;</p> </div> <div style="text-align: center;"> <p>&lt;Twist&gt;</p> </div> </div>

### 4. Soldering

Precautions	<ul style="list-style-type: none"> <li>◆ Reflow soldering             <ol style="list-style-type: none"> <li>1. Please contact any of our offices for a reflow soldering, and refer to the recommended condition specified.</li> <li>2. The product shall be used reflow soldering only.</li> <li>3. Please do not add any stress to a product until it returns in normal temperature after reflow soldering.</li> </ol> </li> <li>◆ Lead free soldering             <ol style="list-style-type: none"> <li>1. When using products with lead free soldering, we request to use them after confirming adhesion, temperature of resistance to soldering heat, soldering etc sufficiently.</li> </ol> </li> <li>◆ Recommended conditions for using a soldering iron(Repair)             <ul style="list-style-type: none"> <li>• Put the soldering iron on the land-pattern.</li> <li>• Soldering iron's temperature - Below 350°C</li> <li>• Duration - 3 seconds or less</li> <li>• The soldering iron should not directly touch the inductor.</li> </ul> </li> </ul>
Technical considerations	<ul style="list-style-type: none"> <li>◆ Reflow soldering             <ol style="list-style-type: none"> <li>1. If products are used beyond the range of the recommended conditions, heat stresses may deform the products, and consequently degrade the reliability of the products. Recommended reflow condition (Pb free solder) <u>LAXH/LCXN/LCXP/LBXN/LBXP/LMXN/LMXP,</u> <u>LCXH/LCXA/LBXH/LMXH, LCRN/LBRN/LMRN</u></li> </ol> </li> </ul> <div style="display: flex; justify-content: space-around;"> <div style="text-align: center;"> </div> <div style="text-align: center;"> </div> </div>

▶ This catalog contains the typical specification only due to the limitation of space. When you consider the purchase of our products, please check our specification. For details of each product (characteristics graph, reliability information, precautions for use, and so on), see our Web site (<http://www.ty-top.com/>)

5. Cleaning	
Precautions	<ul style="list-style-type: none"> <li>◆ Cleaning conditions</li> <li>1. Washing by supersonic waves shall be avoided.</li> </ul>
Technical considerations	<ul style="list-style-type: none"> <li>◆ Cleaning conditions</li> <li>1. If washed by supersonic waves, the products might be broken.</li> </ul>
6. Handling	
Precautions	<ul style="list-style-type: none"> <li>◆ Handling</li> <li>1. Keep the product away from all magnets and magnetic objects.</li> <li>◆ Breakaway PC boards (splitting along perforations)</li> <li>1. When splitting the PC board after mounting product, care should be taken not to give any stresses of deflection or twisting to the board.</li> <li>2. Board separation should not be done manually, but by using the appropriate devices.</li> <li>◆ Mechanical considerations</li> <li>1. Please do not give the product any excessive mechanical shocks.</li> <li>2. Please do not add any shock and power to a product in transportation.</li> <li>◆ Pick-up pressure</li> <li>1. Please do not push to add any pressure to a winding part. Please do not give any shock and push into a ferrite core exposure part.</li> <li>◆ Packing</li> <li>1. Please avoid accumulation of a packing box as much as possible.</li> </ul>
Technical considerations	<ul style="list-style-type: none"> <li>◆ Handling</li> <li>1. There is a case that a characteristic varies with magnetic influence.</li> <li>◆ Breakaway PC boards (splitting along perforations)</li> <li>1. The position of the product on PCBs shall be carefully considered to minimize the stress caused from splitting of the PCBs.</li> <li>◆ Mechanical considerations</li> <li>1. There is a case to be damaged by a mechanical shock.</li> <li>2. There is a case to be broken by the handling in transportation.</li> <li>◆ Pick-up pressure</li> <li>1. Damage and a characteristic can vary with an excessive shock or stress.</li> <li>◆ Packing</li> <li>1. If packing boxes are accumulated, that could cause a deformation on packing tapes or a damage on the products.</li> </ul>
7. Storage conditions	
Precautions	<ul style="list-style-type: none"> <li>◆ Storage</li> <li>1. To maintain the solderability of terminal electrodes and to keep the packing material in good condition, temperature and humidity in the storage area should be controlled. <ul style="list-style-type: none"> <li>▪ Storage conditions</li> <li>Ambient temperature : <math>-5\sim 40^{\circ}\text{C}</math></li> <li>Humidity : Below 70% RH</li> <li>▪ The recommended ambient temperature is below <math>30^{\circ}\text{C}</math>. Even under ideal storage conditions, solderability of products electrodes may decrease as time passes.</li> <li>For this reason, product should be used within 6 months from the time of delivery.</li> <li>In case of storage over 6 months, solderability shall be checked before actual usage.</li> </ul> </li> </ul>
Technical considerations	<ul style="list-style-type: none"> <li>◆ Storage</li> <li>1. Under a high temperature and humidity environment, problems such as reduced solderability caused by oxidation of terminal electrodes and deterioration of taping/packaging materials may take place.</li> </ul>

## 通信基础设备 / 工业设备用途 绕线型铁氧体系功率电感器 LBRN 系列

系列前的记号来自型号，用来区分产品的种类和特性等。

回流焊

■ 型号标示法

\*使用温度范围：-40~125℃（包含产品本身发热）

L	B	R	N	J	1	0	1	4	5	G	L	1	0	0	M	N
①	②	③	④	⑤	⑥	⑦	⑧	⑨								

## ① 系列

代码 (1) (2) (3) (4)	
LBRN	通信基础设备 / 工业设备用途绕线型铁氧体系功率电感器

## (1) 产品群

代码	
L	电感器

## (2) 范畴

代码	推荐设备	品质等级
B	通信基础设备 / 工业设备	2

## ② 特征

代码	特征
J	底面电极（固定夹座型）

## ③ 尺寸 (L×W)

代码	尺寸 (L×W) [mm]
101	10.1×10.1
125	12.5×12.5

## ④ 尺寸 (H)

代码	尺寸 (H) [mm]
45	4.5
55	5.5
65	6.5
75	7.5

## ⑤ 使用温度范围

代码	使用温度范围 [°C]
G	-40~+125

## (3) 类型

代码	
R	绕线型铁氧体系 鼓形筒状固定夹座型

## (4) 特效 / 特性

代码	
N	一般功率扼流

## ⑥ 包装

代码	包装
L	卷盘带装

## ⑦ 标称电感值

代码 (例)	标称电感值 [μH]
1R0	1.0
100	10
101	100

※R=小数点

## ⑧ 电感量公差

代码	电感量公差
M	±20%
N	±30%

## ⑨ 管理记号

## ■标准外型尺寸 / 最小订货单位数量

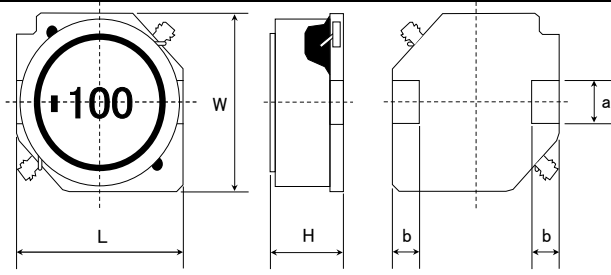

Type	L	W	H	a	b	最小订货单位数量 [pcs]
10145	10.1±0.3 (0.398±0.012)	10.1±0.3 (0.398±0.012)	4.5±0.35 (0.177±0.014)	2.8±0.1 (0.110±0.004)	2.0±0.15 (0.079±0.006)	2000
10155	10.1±0.3 (0.398±0.012)	10.1±0.3 (0.398±0.012)	5.5±0.35 (0.217±0.014)	2.8±0.1 (0.110±0.004)	2.0±0.15 (0.079±0.006)	2000
10165	10.1±0.3 (0.398±0.012)	10.1±0.3 (0.398±0.012)	6.5±0.35 (0.256±0.014)	2.8±0.1 (0.110±0.004)	2.0±0.15 (0.079±0.006)	2000
12555	12.5±0.3 (0.492±0.012)	12.5±0.3 (0.492±0.012)	5.5±0.35 (0.217±0.014)	3.0±0.1 (0.118±0.004)	2.0±0.15 (0.079±0.006)	2000
12565	12.5±0.3 (0.492±0.012)	12.5±0.3 (0.492±0.012)	6.5±0.35 (0.256±0.014)	3.0±0.1 (0.118±0.004)	2.0±0.15 (0.079±0.006)	2000
12575	12.5±0.3 (0.492±0.012)	12.5±0.3 (0.492±0.012)	7.5±0.35 (0.295±0.014)	3.0±0.1 (0.118±0.004)	2.0±0.15 (0.079±0.006)	2000

单位: mm (inch)

## 推荐焊盘图案

## 安装上的注意

- 请确认安装状态后使用。
- 本产品焊法限定为回流焊法。

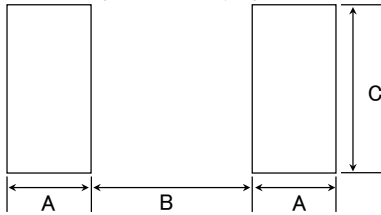

Type	A	B	C
10145	2.5	5.6	3.2
10155	2.5	5.6	3.2
10165	2.5	5.6	3.2
12555	2.5	8.6	3.2
12565	2.5	8.6	3.2
12575	2.5	8.6	3.2

单位: mm

## PART NUMBER

• All the Wire-wound Ferrite Power Inductors of the catalog lineup are RoHS compliant.

## Notes)

- The exchange of individual specifications is necessary depending on your application and/or circuit condition. Please contact TAIYO YUDEN's official sales channel.
- The products are for Telecommunications infrastructure and Industrial equipment. Please consult with TAIYO YUDEN's official sales channel for the details of the product specifications, etc., and please review and approve the product specifications before ordering.

## 10145 type

New part number	Old part number (for reference)	Nominal inductance [ $\mu$ H]	Inductance tolerance	DC Resistance [ $\Omega$ ]( $\pm 20\%$ )	Rated current ※) [A]		Measuring frequency[kHz]
					Saturation current Idc1	Temperature rise current Idc2	
LBRNJ10145GL1R0NN	NS 10145T 1R0NNV8	1.0	$\pm 30\%$	0.0049	12.54	8.90	100
LBRNJ10145GL1R5NN	NS 10145T 1R5NNV8	1.5	$\pm 30\%$	0.0060	10.34	7.99	100
LBRNJ10145GL2R2NN	NS 10145T 2R2NNV8	2.2	$\pm 30\%$	0.0085	8.91	6.64	100
LBRNJ10145GL3R3NN	NS 10145T 3R3NNV8	3.3	$\pm 30\%$	0.0100	7.33	6.10	100
LBRNJ10145GL4R7NN	NS 10145T 4R7NNV8	4.7	$\pm 30\%$	0.0144	6.69	5.03	100
LBRNJ10145GL5R6NN	NS 10145T 5R6NNV8	5.6	$\pm 30\%$	0.0181	5.85	4.45	100
LBRNJ10145GL6R8NN	NS 10145T 6R8NNV8	6.8	$\pm 30\%$	0.0230	5.05	4.22	100
LBRNJ10145GL100MN	NS 10145T 100MNV8	10	$\pm 20\%$	0.0270	4.22	3.10	100
LBRNJ10145GL150MN	NS 10145T 150MNV8	15	$\pm 20\%$	0.0381	3.44	3.00	100
LBRNJ10145GL220MN	NS 10145T 220MNV8	22	$\pm 20\%$	0.0570	2.87	2.30	100
LBRNJ10145GL330MN	NS 10145T 330MNV8	33	$\pm 20\%$	0.0880	2.36	1.90	100
LBRNJ10145GL470MN	NS 10145T 470MNV8	47	$\pm 20\%$	0.130	2.00	1.50	100
LBRNJ10145GL680MN	NS 10145T 680MNV8	68	$\pm 20\%$	0.150	1.66	1.45	100
LBRNJ10145GL101MN	NS 10145T 101MNV8	100	$\pm 20\%$	0.230	1.40	1.10	100
LBRNJ10145GL151MN	NS 10145T 151MNV8	150	$\pm 20\%$	0.350	1.11	0.86	100
LBRNJ10145GL221MN	NS 10145T 221MNV8	220	$\pm 20\%$	0.510	0.91	0.78	100
LBRNJ10145GL331MN	NS 10145T 331MNV8	330	$\pm 20\%$	0.700	0.71	0.64	100
LBRNJ10145GL471MN	NS 10145T 471MNV8	470	$\pm 20\%$	1.03	0.61	0.52	100
LBRNJ10145GL681MN	NS 10145T 681MNV8	680	$\pm 20\%$	1.57	0.50	0.42	100
LBRNJ10145GL102MN	NS 10145T 102MNV8	1000	$\pm 20\%$	2.58	0.41	0.32	100
LBRNJ10145GL152MN	NS 10145T 152MNV8	1500	$\pm 20\%$	3.70	0.36	0.27	100

## 10155 type

New part number	Old part number (for reference)	Nominal inductance [ $\mu$ H]	Inductance tolerance	DC Resistance [ $\Omega$ ]( $\pm 20\%$ )	Rated current ※) [A]		Measuring frequency[kHz]
					Saturation current Idc1	Temperature rise current Idc2	
LBRNJ10155GL1R5NN	NS 10155T 1R5NNV8	1.5	$\pm 30\%$	0.0060	11.90	8.39	100
LBRNJ10155GL2R2NN	NS 10155T 2R2NNV8	2.2	$\pm 30\%$	0.0072	10.00	7.61	100
LBRNJ10155GL3R3NN	NS 10155T 3R3NNV8	3.3	$\pm 30\%$	0.0097	8.50	6.49	100
LBRNJ10155GL4R7NN	NS 10155T 4R7NNV8	4.7	$\pm 30\%$	0.0112	7.40	6.01	100
LBRNJ10155GL6R8NN	NS 10155T 6R8NNV8	6.8	$\pm 30\%$	0.0159	6.00	4.98	100
LBRNJ10155GL100MN	NS 10155T 100MNV8	10	$\pm 20\%$	0.0200	4.49	4.40	100
LBRNJ10155GL150MN	NS 10155T 150MNV8	15	$\pm 20\%$	0.0310	4.03	3.40	100
LBRNJ10155GL220MN	NS 10155T 220MNV8	22	$\pm 20\%$	0.0430	3.37	2.80	100

## 10165 type

New part number	Old part number (for reference)	Nominal inductance [ $\mu$ H]	Inductance tolerance	DC Resistance [ $\Omega$ ]( $\pm 20\%$ )	Rated current ※) [A]		Measuring frequency[kHz]
					Saturation current Idc1	Temperature rise current Idc2	
LBRNJ10165GL1R5NN	NS 10165T 1R5NNV8	1.5	$\pm 30\%$	0.0062	13.60	8.04	100
LBRNJ10165GL2R2NN	NS 10165T 2R2NNV8	2.2	$\pm 30\%$	0.0074	10.80	7.32	100
LBRNJ10165GL3R3NN	NS 10165T 3R3NNV8	3.3	$\pm 30\%$	0.0086	9.30	6.76	100
LBRNJ10165GL4R7NN	NS 10165T 4R7NNV8	4.7	$\pm 30\%$	0.0112	7.70	5.88	100
LBRNJ10165GL6R8NN	NS 10165T 6R8NNV8	6.8	$\pm 30\%$	0.0140	6.00	5.22	100
LBRNJ10165GL100MN	NS 10165T 100MNV8	10	$\pm 20\%$	0.0174	5.20	4.66	100
LBRNJ10165GL150MN	NS 10165T 150MNV8	15	$\pm 20\%$	0.0280	3.60	3.84	100
LBRNJ10165GL220MN	NS 10165T 220MNV8	22	$\pm 20\%$	0.0350	3.10	3.41	100

※) The saturation current value (Idc1) is the DC current value having inductance decrease down to 30%. (at 20°C)

※) The temperature rise current value (Idc2) is the DC current value having temperature increase up to 40°C. (at 20°C)

※) The rated current is the DC current value that satisfies both of current value saturation current value and temperature rise current value.

■ PART NUMBER

● 12555 type

New part number	Old part number (for reference)	Nominal inductance [ $\mu$ H]	Inductance tolerance	DC Resistance [ $\Omega$ ] ( $\pm 20\%$ )	Rated current ※) [A]		Measuring frequency [kHz]
					Saturation current Idc1	Temperature rise current Idc2	
LBRNJ12555GL6R0NN	NS 12555T 6R0NN 8	6.0	$\pm 30\%$	0.0140	5.01	5.60	100
LBRNJ12555GL100MN	NS 12555T 100MN 8	10	$\pm 20\%$	0.0175	4.73	5.04	100
LBRNJ12555GL150MN	NS 12555T 150MN 8	15	$\pm 20\%$	0.0233	3.89	4.18	100
LBRNJ12555GL220MN	NS 12555T 220MN 8	22	$\pm 20\%$	0.0297	3.20	3.81	100
LBRNJ12555GL330MN	NS 12555T 330MN 8	33	$\pm 20\%$	0.0415	2.64	3.16	100
LBRNJ12555GL470MN	NS 12555T 470MN 8	47	$\pm 20\%$	0.0618	2.23	2.70	100
LBRNJ12555GL680MN	NS 12555T 680MN 8	68	$\pm 20\%$	0.0832	1.81	2.14	100
LBRNJ12555GL101MN	NS 12555T 101MN 8	100	$\pm 20\%$	0.117	1.53	1.86	100
LBRNJ12555GL151MN	NS 12555T 151MN 8	150	$\pm 20\%$	0.215	1.10	1.30	100
LBRNJ12555GL221MN	NS 12555T 221MN 8	220	$\pm 20\%$	0.270	1.00	1.18	100
LBRNJ12555GL331MN	NS 12555T 331MN 8	330	$\pm 20\%$	0.410	0.82	0.96	100
LBRNJ12555GL471MN	NS 12555T 471MN 8	470	$\pm 20\%$	0.520	0.68	0.80	100
LBRNJ12555GL681MN	NS 12555T 681MN 8	680	$\pm 20\%$	0.870	0.48	0.61	100
LBRNJ12555GL102MN	NS 12555T 102MN 8	1000	$\pm 20\%$	1.44	0.41	0.46	100
LBRNJ12555GL152MN	NS 12555T 152MN 8	1500	$\pm 20\%$	1.73	0.40	0.44	100

● 12565 type

New part number	Old part number (for reference)	Nominal inductance [ $\mu$ H]	Inductance tolerance	DC Resistance [ $\Omega$ ] ( $\pm 20\%$ )	Rated current ※) [A]		Measuring frequency [kHz]
					Saturation current Idc1	Temperature rise current Idc2	
LBRNJ12565GL2R0NN	NS 12565T 2R0NN 8	2.0	$\pm 30\%$	0.0080	13.91	7.60	100
LBRNJ12565GL4R2NN	NS 12565T 4R2NN 8	4.2	$\pm 30\%$	0.0126	9.40	5.91	100
LBRNJ12565GL7R0NN	NS 12565T 7R0NN 8	7.0	$\pm 30\%$	0.0162	7.80	5.21	100
LBRNJ12565GL100MN	NS 12565T 100MN 8	10	$\pm 20\%$	0.0199	6.00	4.75	100
LBRNJ12565GL150MN	NS 12565T 150MN 8	15	$\pm 20\%$	0.0237	5.60	4.33	100
LBRNJ12565GL220MN	NS 12565T 220MN 8	22	$\pm 20\%$	0.0310	4.20	3.91	100
LBRNJ12565GL330MN	NS 12565T 330MN 8	33	$\pm 20\%$	0.0390	3.80	3.22	100
LBRNJ12565GL470MN	NS 12565T 470MN 8	47	$\pm 20\%$	0.0575	3.34	2.78	100
LBRNJ12565GL680MN	NS 12565T 680MN 8	68	$\pm 20\%$	0.0775	2.70	2.30	100
LBRNJ12565GL101MN	NS 12565T 101MN 8	100	$\pm 20\%$	0.123	2.23	1.81	100
LBRNJ12565GL151MN	NS 12565T 151MN 8	150	$\pm 20\%$	0.173	1.80	1.54	100
LBRNJ12565GL221MN	NS 12565T 221MN 8	220	$\pm 20\%$	0.273	1.39	1.18	100

● 12575 type

New part number	Old part number (for reference)	Nominal inductance [ $\mu$ H]	Inductance tolerance	DC Resistance [ $\Omega$ ] ( $\pm 20\%$ )	Rated current ※) [A]		Measuring frequency [kHz]
					Saturation current Idc1	Temperature rise current Idc2	
LBRNJ12575GL1R2NN	NS 12575T 1R2NN 8	1.2	$\pm 30\%$	0.0058	18.08	9.15	100
LBRNJ12575GL2R7NN	NS 12575T 2R7NN 8	2.7	$\pm 30\%$	0.0085	13.91	7.69	100
LBRNJ12575GL3R9NN	NS 12575T 3R9NN 8	3.9	$\pm 30\%$	0.0099	12.10	7.38	100
LBRNJ12575GL5R6NN	NS 12575T 5R6NN 8	5.6	$\pm 30\%$	0.0116	10.20	6.36	100
LBRNJ12575GL6R8NN	NS 12575T 6R8NN 8	6.8	$\pm 30\%$	0.0131	9.50	5.84	100
LBRNJ12575GL100MN	NS 12575T 100MN 8	10	$\pm 20\%$	0.0156	7.65	5.55	100
LBRNJ12575GL150MN	NS 12575T 150MN 8	15	$\pm 20\%$	0.0184	6.30	5.22	100
LBRNJ12575GL220MN	NS 12575T 220MN 8	22	$\pm 20\%$	0.0260	5.50	4.05	100
LBRNJ12575GL330MN	NS 12575T 330MN 8	33	$\pm 20\%$	0.0390	4.30	3.48	100
LBRNJ12575GL470MN	NS 12575T 470MN 8	47	$\pm 20\%$	0.0515	3.60	2.95	100
LBRNJ12575GL680MN	NS 12575T 680MN 8	68	$\pm 20\%$	0.0900	2.78	2.10	100
LBRNJ12575GL101MN	NS 12575T 101MN 8	100	$\pm 20\%$	0.110	2.50	2.01	100
LBRNJ12575GL151MN	NS 12575T 151MN 8	150	$\pm 20\%$	0.161	1.90	1.51	100
LBRNJ12575GL221MN	NS 12575T 221MN 8	220	$\pm 20\%$	0.300	1.60	1.10	100
LBRNJ12575GL102MN	NS 12575T 102MN 8	1000	$\pm 20\%$	1.170	0.72	0.53	100

- ※) The saturation current value (Idc1) is the DC current value having inductance decrease down to 30%. (at 20°C)
- ※) The temperature rise current value (Idc2) is the DC current value having temperature increase up to 40°C. (at 20°C)
- ※) The rated current is the DC current value that satisfies both of current value saturation current value and temperature rise current value.

■ Derating of Rated Current

● LBRN series

Derating of current is necessary for LBRN series depending on ambient temperature.  
Please refer to the chart shown below for appropriate derating of current.

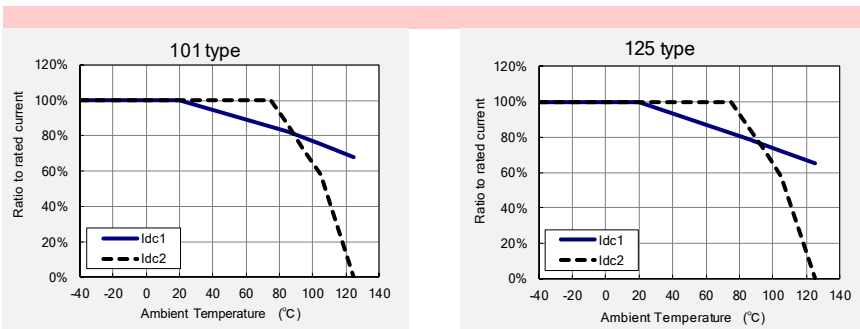

▶ This catalog contains the typical specification only due to the limitation of space. When you consider the purchase of our products, please check our specification.  
For details of each product (characteristics graph, reliability information, precautions for use, and so on), see our Web site (<http://www.ty-top.com/>).

# Wire-wound Ferrite Power Inductors LSRN/LCRN/LBRN/LLRN/LMRN series

## PACKAGING

### ① Packing Quantity

Type	Standard Quantity (1reel) [pcs]	Minimum Quantity [pcs]
	Embossed Tape	Embossed Tape
10145	500	2000
10155	500	2000
10165	500	2000
12555	500	2000
12565	500	2000
12575	500	2000

### ② Tape Material

#### ● Embossed Tape

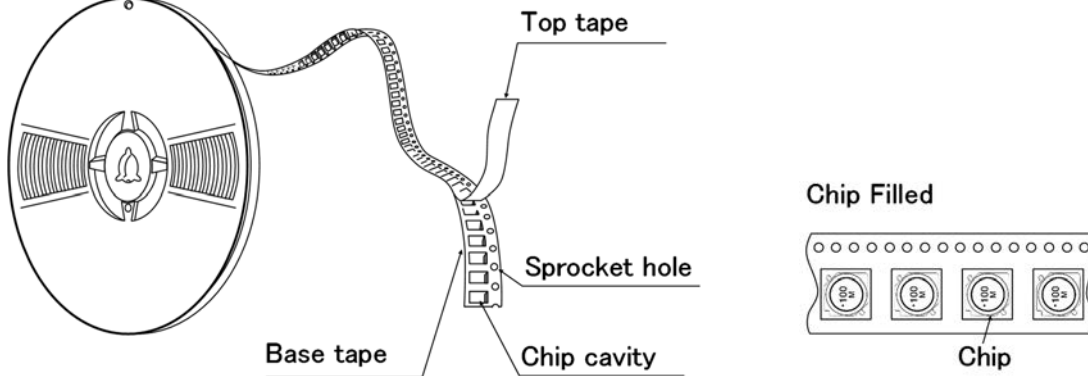

### ③ Taping dimensions

#### ● Embossed tape 24mm wide (0.945 inches wide)

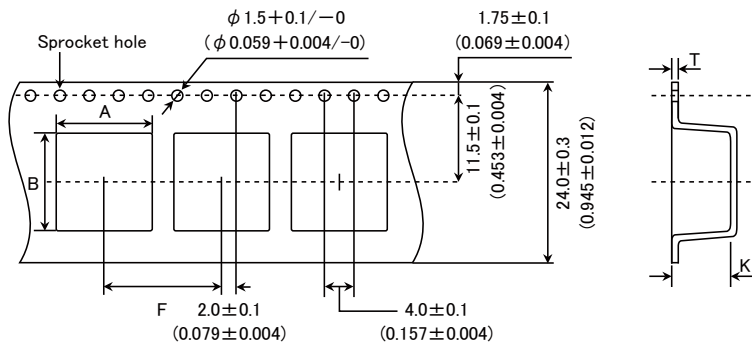

Type	Chip cavity		Insertion pitch	Tape thickness	
	A	B	F	T	K
10145	$10.5 \pm 0.1$ ( $0.413 \pm 0.004$ )	$10.5 \pm 0.1$ ( $0.413 \pm 0.004$ )	$16.0 \pm 0.1$ ( $0.630 \pm 0.004$ )	$0.4 \pm 0.1$ ( $0.016 \pm 0.004$ )	$5.0 \pm 0.1$ ( $0.197 \pm 0.004$ )
10155	$10.5 \pm 0.1$ ( $0.413 \pm 0.004$ )	$10.5 \pm 0.1$ ( $0.413 \pm 0.004$ )	$16.0 \pm 0.1$ ( $0.630 \pm 0.004$ )	$0.4 \pm 0.1$ ( $0.016 \pm 0.004$ )	$6.0 \pm 0.1$ ( $0.236 \pm 0.004$ )
10165	$10.5 \pm 0.1$ ( $0.413 \pm 0.004$ )	$10.5 \pm 0.1$ ( $0.413 \pm 0.004$ )	$16.0 \pm 0.1$ ( $0.630 \pm 0.004$ )	$0.4 \pm 0.1$ ( $0.016 \pm 0.004$ )	$7.0 \pm 0.1$ ( $0.276 \pm 0.004$ )
12555	$13.0 \pm 0.1$ ( $0.512 \pm 0.004$ )	$13.0 \pm 0.1$ ( $0.512 \pm 0.004$ )	$16.0 \pm 0.1$ ( $0.630 \pm 0.004$ )	$0.4 \pm 0.1$ ( $0.016 \pm 0.004$ )	$6.1 \pm 0.1$ ( $0.240 \pm 0.004$ )
12565	$13.0 \pm 0.1$ ( $0.512 \pm 0.004$ )	$13.0 \pm 0.1$ ( $0.512 \pm 0.004$ )	$16.0 \pm 0.1$ ( $0.630 \pm 0.004$ )	$0.4 \pm 0.1$ ( $0.016 \pm 0.004$ )	$7.1 \pm 0.1$ ( $0.280 \pm 0.004$ )
12575	$13.0 \pm 0.1$ ( $0.512 \pm 0.004$ )	$13.0 \pm 0.1$ ( $0.512 \pm 0.004$ )	$16.0 \pm 0.1$ ( $0.630 \pm 0.004$ )	$0.4 \pm 0.1$ ( $0.016 \pm 0.004$ )	$8.0 \pm 0.1$ ( $0.315 \pm 0.004$ )

Unit : mm (inch)

▶ This catalog contains the typical specification only due to the limitation of space. When you consider the purchase of our products, please check our specification. For details of each product (characteristics graph, reliability information, precautions for use, and so on), see our Web site (<http://www.ty-top.com/>).

④ Leader and Blank portion

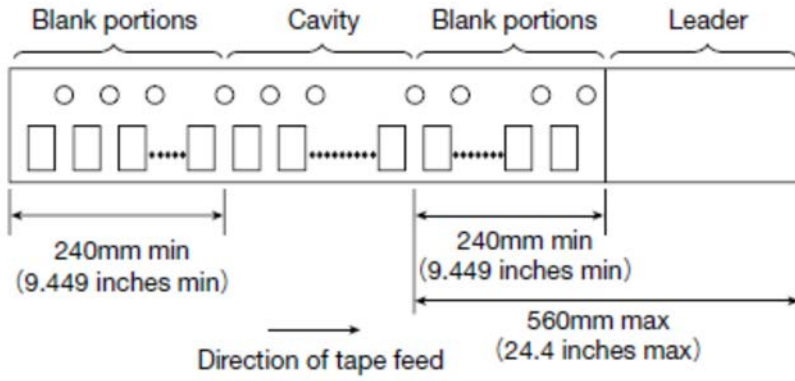

⑤ Reel size

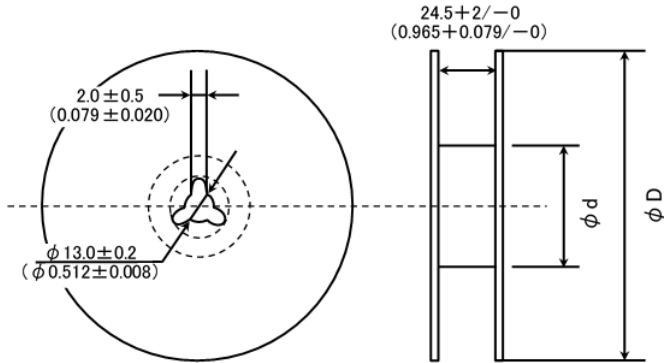

Type	Reel size (Reference values)	
	$\phi D$	$\phi d$
10145	330 ± 2 (12.99 ± 0.079)	100 ± 1 (3.937 ± 0.039)
10155		
10165		
12555		
12565		
12575		

Unit : mm (inch)

⑥ Top Tape Strength

The top tape requires a peel-off force of 0.1 to 1.3N in the direction of the arrow as illustrated below.

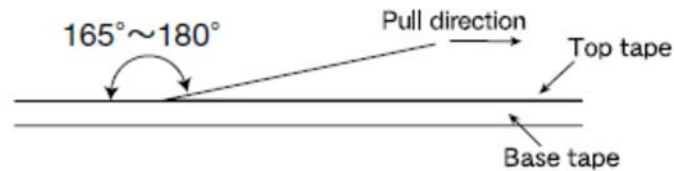



**Wire-wound Ferrite Power Inductors LBRN series  
for Telecommunications Infrastructure and Industrial Equipment**  
**Wire-wound Ferrite Power Inductors LMRN series  
for Medical Devices classified as GHTF Class C (Japan Class III)**

■ RELIABILITY DATA

1. Operating Temperature Range

Specified Value	-40~+125°C (Including self-generated heat)
Test Methods and Remarks	Including self-generated heat

2. Storage Temperature Range

Specified Value	-40~+85°C
Test Methods and Remarks	-5 to 40°C for the product with taping.

3. Rated current

Specified Value	Within the specified tolerance
-----------------	--------------------------------

4. Inductance

Specified Value	Within the specified tolerance
Test Methods and Remarks	Measuring equipment : LCR Meter (HP 4285A or equivalent) Measuring frequency : 100kHz, 1V

5. DC Resistance

Specified Value	Within the specified tolerance
Test Methods and Remarks	Measuring equipment : DC ohmmeter (HIOKI 3227 or equivalent)

6. Self resonance frequency

Specified Value	—
-----------------	---

7. Temperature characteristic

Specified Value	Inductance change : Within $\pm 15\%$												
Test Methods and Remarks	Measurement of inductance shall be taken at temperature range within $-40^{\circ}\text{C}\sim +125^{\circ}\text{C}$ . With reference to inductance value at $+20^{\circ}\text{C}$ ., change rate shall be calculated. Change of maximum inductance deviation in step 1 to 5												
	<table border="1"> <thead> <tr> <th>Step</th> <th>Temperature (°C)</th> </tr> </thead> <tbody> <tr> <td>1</td> <td>20</td> </tr> <tr> <td>2</td> <td>Minimum operating temperature</td> </tr> <tr> <td>3</td> <td>20 (Standard temperature)</td> </tr> <tr> <td>4</td> <td>Maximum operating temperature</td> </tr> <tr> <td>5</td> <td>20</td> </tr> </tbody> </table>	Step	Temperature (°C)	1	20	2	Minimum operating temperature	3	20 (Standard temperature)	4	Maximum operating temperature	5	20
	Step	Temperature (°C)											
	1	20											
	2	Minimum operating temperature											
	3	20 (Standard temperature)											
	4	Maximum operating temperature											
5	20												

**8. Resistance to flexure of substrate**

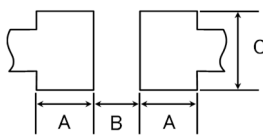
Specified Value	No damage															
Test Methods and Remarks	The test samples shall be soldered to the test board by the reflow. As illustrated below, apply force in the direction of the arrow indicating until deflection of the test board reaches to 2 mm.															
	Test board size : 100 × 40 × 1.0															
	Test board material : glass epoxy-resin															
	Solder cream thickness : 0.15 mm															
	Land dimension															
																
		<table border="1"> <thead> <tr> <th>Type</th> <th>A</th> <th>B</th> <th>C</th> </tr> </thead> <tbody> <tr> <td>101</td> <td>2.5</td> <td>5.6</td> <td>3.2</td> </tr> <tr> <td>125</td> <td>2.5</td> <td>8.6</td> <td>3.2</td> </tr> </tbody> </table>	Type	A	B	C	101	2.5	5.6	3.2	125	2.5	8.6	3.2		
Type	A	B	C													
101	2.5	5.6	3.2													
125	2.5	8.6	3.2													

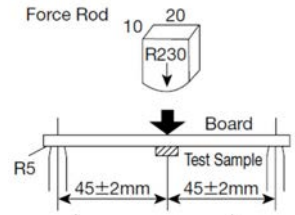

**9. Insulation resistance : between wires**

Specified Value	—
-----------------	---

**10. Insulation resistance : between wire and core**

Specified Value	—
-----------------	---

**11. Withstanding voltage : between wire and core**

Specified Value	—
-----------------	---

**12. Adhesion of terminal electrode**

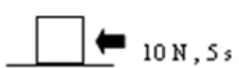
Specified Value	Shall not come off PC board
Test Methods and Remarks	The test samples shall be soldered to the test board by the reflow.
	Applied force : 10N to X and Y directions. Duration : 5s. Solder cream thickness : 0.15mm
	

**13. Resistance to vibration**

Specified Value	Inductance change : Within ±10%	
	No significant abnormality in appearance.	
Test Methods and Remarks	The test samples shall be soldered to the test board by the reflow.	
	Then it shall be submitted to below test conditions.	
	Frequency Range	10~55Hz
	Total Amplitude	1.5mm (May not exceed acceleration 196m/s <sup>2</sup> )
	Sweeping Method	10Hz to 55Hz to 10Hz for 1min.
Time	X Y Z	For 2 hours on each X, Y, and Z axis.
	Recovery : At least 2hrs of recovery under the standard condition after the test, followed by the measurement within 48hrs.	

► This catalog contains the typical specification only due to the limitation of space. When you consider the purchase of our products, please check our specification. For details of each product (characteristics graph, reliability information, precautions for use, and so on), see our Web site (<http://www.ty-top.com/>).

#### 14. Solderability

Specified Value	At least 90% of surface of terminal electrode is covered by new solder.				
Test Methods and Remarks	<p>The test samples shall be dipped in flux, and then immersed in molten solder as shown in below table. Flux : Ethanol solution containing rosin 25%.</p> <table border="1"> <tr> <td>Solder Temperature</td> <td>245±5°C</td> </tr> <tr> <td>Time</td> <td>5±1.0 sec.</td> </tr> </table> <p>※Immersion depth : All sides of mounting terminal shall be immersed.</p>	Solder Temperature	245±5°C	Time	5±1.0 sec.
Solder Temperature	245±5°C				
Time	5±1.0 sec.				

#### 15. Resistance to soldering heat

Specified Value	Inductance change : Within ±10% No significant abnormality in appearance.
Test Methods and Remarks	<p>The test sample shall be exposed to reflow oven at 230±5°C for 40 seconds, with peak temperature at 260±5°C for 5 seconds, 2 times.</p> <p>Test board material : glass epoxy-resin Test board thickness : 1.0mm Recovery : At least 2hrs of recovery under the standard condition after the test, followed by the measurement within 48hrs.</p>

#### 16. Thermal shock

Specified Value	Inductance change : Within ±10% No significant abnormality in appearance.																		
Test Methods and Remarks	<p>The test samples shall be soldered to the test board by the reflow. The test samples shall be placed at specified temperature for specified time by step 1 to step 4 as shown in below table in sequence. The temperature cycle shall be repeated 100 cycles.</p> <table border="1"> <thead> <tr> <th colspan="3">Conditions of 1 cycle</th> </tr> <tr> <th>Step</th> <th>Temperature (°C)</th> <th>Duration (min)</th> </tr> </thead> <tbody> <tr> <td>1</td> <td>-40±3</td> <td>30±3</td> </tr> <tr> <td>2</td> <td>Room temperature</td> <td>Within 3</td> </tr> <tr> <td>3</td> <td>+85±2</td> <td>30±3</td> </tr> <tr> <td>4</td> <td>Room temperature</td> <td>Within 3</td> </tr> </tbody> </table> <p>Recovery : At least 2hrs of recovery under the standard condition after the test, followed by the measurement within 48hrs.</p>	Conditions of 1 cycle			Step	Temperature (°C)	Duration (min)	1	-40±3	30±3	2	Room temperature	Within 3	3	+85±2	30±3	4	Room temperature	Within 3
Conditions of 1 cycle																			
Step	Temperature (°C)	Duration (min)																	
1	-40±3	30±3																	
2	Room temperature	Within 3																	
3	+85±2	30±3																	
4	Room temperature	Within 3																	

#### 17. Damp heat

Specified Value	Inductance change : Within ±10% No significant abnormality in appearance.						
Test Methods and Remarks	<p>The test samples shall be soldered to the test board by the reflow. The test samples shall be placed in thermostatic oven set at specified temperature and humidity as shown in below table.</p> <table border="1"> <tr> <td>Temperature</td> <td>60±2°C</td> </tr> <tr> <td>Humidity</td> <td>90~95%RH</td> </tr> <tr> <td>Time</td> <td>500+24/-0 hour</td> </tr> </table> <p>Recovery : At least 2hrs of recovery under the standard condition after the test, followed by the measurement within 48hrs.</p>	Temperature	60±2°C	Humidity	90~95%RH	Time	500+24/-0 hour
Temperature	60±2°C						
Humidity	90~95%RH						
Time	500+24/-0 hour						

#### 18. Loading under damp heat

Specified Value	Inductance change : Within ±10% No significant abnormality in appearance.								
Test Methods and Remarks	<p>The test samples shall be soldered to the test board by the reflow. The test samples shall be placed in thermostatic oven set at specified temperature and humidity and applied the rated current continuously as shown in below table.</p> <table border="1"> <tr> <td>Temperature</td> <td>60±2°C</td> </tr> <tr> <td>Humidity</td> <td>90~95%RH</td> </tr> <tr> <td>Applied current</td> <td>Rated current</td> </tr> <tr> <td>Time</td> <td>500+24/-0 hour</td> </tr> </table> <p>Recovery : At least 2hrs of recovery under the standard condition after the test, followed by the measurement within 48hrs.</p>	Temperature	60±2°C	Humidity	90~95%RH	Applied current	Rated current	Time	500+24/-0 hour
Temperature	60±2°C								
Humidity	90~95%RH								
Applied current	Rated current								
Time	500+24/-0 hour								

19. Low temperature life test

Specified Value	Inductance change : Within $\pm 10\%$ No significant abnormality in appearance.				
Test Methods and Remarks	The test samples shall be soldered to the test board by the reflow. After that, the test samples shall be placed at test conditions as shown in below table. <table border="1" data-bbox="295 271 715 331"> <tr> <td>Temperature</td> <td><math>-40 \pm 2^\circ\text{C}</math></td> </tr> <tr> <td>Time</td> <td>500+24/-0 hour</td> </tr> </table> Recovery : At least 2hrs of recovery under the standard condition after the test, followed by the measurement within 48hrs.	Temperature	$-40 \pm 2^\circ\text{C}$	Time	500+24/-0 hour
Temperature	$-40 \pm 2^\circ\text{C}$				
Time	500+24/-0 hour				

20. High temperature life test

Specified Value	—
-----------------	---

21. Loading at high temperature life test

Specified Value	Inductance change : Within $\pm 10\%$ No significant abnormality in appearance.						
Test Methods and Remarks	The test samples shall be soldered to the test board by the reflow soldering. <table border="1" data-bbox="295 640 715 730"> <tr> <td>Temperature</td> <td><math>85 \pm 2^\circ\text{C}</math></td> </tr> <tr> <td>Applied current</td> <td>Rated current</td> </tr> <tr> <td>Time</td> <td>500+24/-0 hour</td> </tr> </table> Recovery : At least 2hrs of recovery under the standard condition after the test, followed by the measurement within 48hrs.	Temperature	$85 \pm 2^\circ\text{C}$	Applied current	Rated current	Time	500+24/-0 hour
Temperature	$85 \pm 2^\circ\text{C}$						
Applied current	Rated current						
Time	500+24/-0 hour						

22. Standard condition

Specified Value	Standard test condition : Unless otherwise specified, temperature is $20 \pm 15^\circ\text{C}$ and $65 \pm 20\%$ of relative humidity. When there is any question concerning measurement result: In order to provide correlation data, the test shall be condition of $20 \pm 2^\circ\text{C}$ of temperature, $65 \pm 5\%$ relative humidity. Inductance is in accordance with our measured value.
-----------------	--

**Wire-wound Ferrite Power Inductors LAYP series for Automotive Powertrain and safety**  
**Wire-wound Ferrite Power Inductors LAXH series for Automotive Powertrain and safety**  
**Wire-wound Ferrite Power Inductors LCXN/LCXP series for Automotive Body & Chassis and Infotainment**  
**Wire-wound Ferrite Power Inductors LCXH series for Automotive Body & Chassis and Infotainment**  
**Wire-wound Ferrite Inductors for Class D Amplifier LCXA for Automotive Body & Chassis and Infotainment**  
**Wire-wound Ferrite Power Inductors LCRN series for Automotive Body & Chassis and Infotainment**  
**Wire-wound Ferrite Power Inductors LBXN/LBXP series**  
**for Telecommunications Infrastructure and Industrial Equipment**  
**Wire-wound Ferrite Power Inductors LBXH series**  
**for Telecommunications Infrastructure and Industrial Equipment**  
**Wire-wound Ferrite Power Inductors LBRN series**  
**for Telecommunications Infrastructure and Industrial Equipment**  
**Wire-wound Ferrite Power Inductors LMXN/LMXP series**  
**for Medical Devices classified as GHTF Class C (Japan Class III)**  
**Wire-wound Ferrite Power Inductors LMXH series**  
**for Medical Devices classified as GHTF Class C (Japan Class III)**  
**Wire-wound Ferrite Power Inductors LMRN series**  
**for Medical Devices classified as GHTF Class C (Japan Class III)**

**■ PRECAUTIONS**

1. Circuit Design	
Precautions	<ul style="list-style-type: none"> <li>◆ Verification of operating environment, electrical rating and performance               <ol style="list-style-type: none"> <li>1. A malfunction in medical equipment, spacecraft, nuclear reactors, etc. may cause serious harm to human life or have severe social ramifications. As such, any inductors to be used in such equipment may require higher safety and/or reliability considerations and should be clearly differentiated from components used in general purpose applications.</li> <li>2. When inductors are used in places where dew condensation develops and/or where corrosive gas such as hydrogen sulfide, sulfurous acid, or chlorine exists in the air, characteristic deterioration may occur. Please do not use inductors under such environmental conditions.</li> </ol> </li> <li>◆ Operating Current (Verification of Rated current)               <ol style="list-style-type: none"> <li>1. The operating current including inrush current for inductors must always be lower than their rated values.</li> <li>2. Do not apply current in excess of the rated value because the inductance may be reduced due to the magnetic saturation effect.</li> </ol> </li> <li>◆ Temperature rise               <p style="margin-left: 20px;">Temperature rise of power choke coil depends on the installation condition in end products.</p> <p style="margin-left: 20px;">Make sure that temperature rise of power choke coils in actual end products is within the specified temperature range.</p> </li> </ul>
2. PCB Design	
Precautions	<ul style="list-style-type: none"> <li>◆ Land pattern design               <ol style="list-style-type: none"> <li>1. Please refer to a recommended land pattern.</li> <li>2. There is stress, which has been caused by distortion of a PCB, to the inductor. (LAXH/LCXN/LCXP/LBXN/LBXP/LMXN/LMXP, LCXH/LCXA/LBXH/LMXH)</li> <li>3. Please consider the arrangement of parts on a PCB. (LAXH/LCXN/LCXP/LBXN/LBXP/LMXN/LMXP, LCXH/LCXA/LBXH/LMXH)</li> </ol> </li> </ul>
Technical considerations	<ul style="list-style-type: none"> <li>◆ Land pattern design               <p>Surface Mounting</p> <ol style="list-style-type: none"> <li>1. Mounting and soldering conditions should be checked beforehand.</li> <li>2. Applicable soldering process to this products is reflow soldering only.</li> <li>3. Please use the recommended land pattern shown as below. Electrical characteristics and the mounting ability of the product are being considered in the recommended land pattern. If a PCB is designed with other dimensions, defective soldering and stress to a product may occur due to misalignment. The performance of the product may not be brought out. If an adopted land pattern is different from the recommended land pattern, stress to the product will increase. It may cause cracks or defective electrical characteristics of the product. Please conduct validation completely before studying adoption of this product and please judge the pros and cons of adoption of this product with taking on responsibility. (LAXH/LCXN/LCXP/LBXN/LBXP/LMXN/LMXP, LCXH/LCXA/LBXH/LMXH)</li> <li>4. As coefficients of thermal expansion between an inductor and a PCB differs, cracks may occur on a ferrite core when thermal stress is applied to them after mounting an inductor. (Please refer to the drawings below.) Please conduct validation completely before studying adoption of this product and please judge the pros and cons of adoption of this product with taking on responsibility. (LAXH/LCXN/LCXP/LBXN/LBXP/LMXN/LMXP, LCXH/LCXA/LBXH/LMXH)</li> </ol> </li> </ul>

▶ This catalog contains the typical specification only due to the limitation of space. When you consider the purchase of our products, please check our specification.  
 For details of each product (characteristics graph, reliability information, precautions for use, and so on), see our Web site (<http://www.ty-top.com/>)

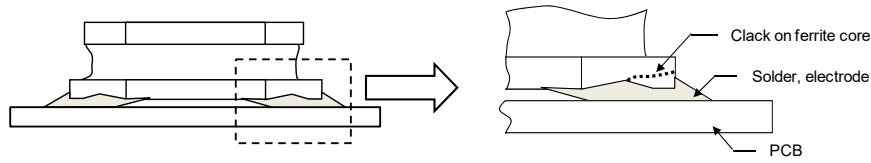

5. SMD inductors should be located to minimize any possible mechanical stresses from board warp or deflection. When splitting the PC board after mounting inductors and other components, care is required so as not to give any stresses of deflection or twisting to the board.

(LAXH/LCXN/LCXP/LBXN/LBXP/LMXN/LMXP, LCXH/LCXA/LBXH/LMXH)

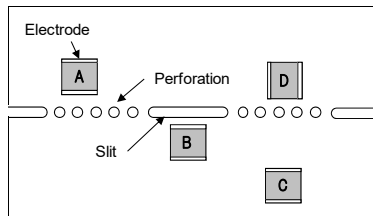

A product tends to undergo stress in order "A>C>B≡D". Please consider the layouts of a product to minimize any stresses.

### 3. Considerations for automatic placement

Precautions	<ul style="list-style-type: none"> <li>◆ Adjustment of mounting machine</li> <li>1. Excessive impact load should not be imposed on the products when mounting onto the PC boards.</li> <li>2. Mounting and soldering conditions should be checked beforehand.</li> </ul>
Technical considerations	<ul style="list-style-type: none"> <li>◆ Adjustment of mounting machine</li> <li>1. When installing products, care should be taken not to apply distortion stress as it may deform the products.</li> <li>2. Stress may be applied to a product with a warp or a twist in handling of the product. Please conduct validation completely before studying adoption of this product and please judge the pros and cons of adoption of this product with taking on responsibility. (LAXH/LCXN/LCXP/LBXN/LBXP/LMXN/LMXP, LCXH/LCXA/LBXH/LMXH)</li> </ul> <div style="display: flex; justify-content: space-around; align-items: center;"> <div style="text-align: center;"> <p>&lt;Wrap&gt;</p> </div> <div style="text-align: center;"> <p>&lt;Twist&gt;</p> </div> </div>

### 4. Soldering

Precautions	<ul style="list-style-type: none"> <li>◆ Reflow soldering</li> <li>1. Please contact any of our offices for a reflow soldering, and refer to the recommended condition specified.</li> <li>2. The product shall be used reflow soldering only.</li> <li>3. Please do not add any stress to a product until it returns in normal temperature after reflow soldering.</li> <li>◆ Lead free soldering</li> <li>1. When using products with lead free soldering, we request to use them after confirming adhesion, temperature of resistance to soldering heat, soldering etc sufficiently.</li> <li>◆ Recommended conditions for using a soldering iron(Repair) <ul style="list-style-type: none"> <li>• Put the soldering iron on the land-pattern.</li> <li>• Soldering iron's temperature - Below 350°C</li> <li>• Duration - 3 seconds or less</li> <li>• The soldering iron should not directly touch the inductor.</li> </ul> </li> </ul>
Technical considerations	<ul style="list-style-type: none"> <li>◆ Reflow soldering</li> <li>1. If products are used beyond the range of the recommended conditions, heat stresses may deform the products, and consequently degrade the reliability of the products.</li> </ul> <p style="text-align: center;">Recommended reflow condition (Pb free solder)  <u>LAXH/LCXN/LCXP/LBXN/LBXP/LMXN/LMXP,</u>  <u>LCXH/LCXA/LBXH/LMXH, LCRN/LBRN/LMRN</u></p> <div style="display: flex; justify-content: space-around;"> <div style="text-align: center;"> </div> <div style="text-align: center;"> </div> </div>

▶ This catalog contains the typical specification only due to the limitation of space. When you consider the purchase of our products, please check our specification. For details of each product (characteristics graph, reliability information, precautions for use, and so on), see our Web site (<http://www.ty-top.com/>)

5. Cleaning	
Precautions	<ul style="list-style-type: none"> <li>◆ Cleaning conditions</li> <li>1. Washing by supersonic waves shall be avoided.</li> </ul>
Technical considerations	<ul style="list-style-type: none"> <li>◆ Cleaning conditions</li> <li>1. If washed by supersonic waves, the products might be broken.</li> </ul>
6. Handling	
Precautions	<ul style="list-style-type: none"> <li>◆ Handling</li> <li>1. Keep the product away from all magnets and magnetic objects.</li> <li>◆ Breakaway PC boards (splitting along perforations)</li> <li>1. When splitting the PC board after mounting product, care should be taken not to give any stresses of deflection or twisting to the board.</li> <li>2. Board separation should not be done manually, but by using the appropriate devices.</li> <li>◆ Mechanical considerations</li> <li>1. Please do not give the product any excessive mechanical shocks.</li> <li>2. Please do not add any shock and power to a product in transportation.</li> <li>◆ Pick-up pressure</li> <li>1. Please do not push to add any pressure to a winding part. Please do not give any shock and push into a ferrite core exposure part.</li> <li>◆ Packing</li> <li>1. Please avoid accumulation of a packing box as much as possible.</li> </ul>
Technical considerations	<ul style="list-style-type: none"> <li>◆ Handling</li> <li>1. There is a case that a characteristic varies with magnetic influence.</li> <li>◆ Breakaway PC boards (splitting along perforations)</li> <li>1. The position of the product on PCBs shall be carefully considered to minimize the stress caused from splitting of the PCBs.</li> <li>◆ Mechanical considerations</li> <li>1. There is a case to be damaged by a mechanical shock.</li> <li>2. There is a case to be broken by the handling in transportation.</li> <li>◆ Pick-up pressure</li> <li>1. Damage and a characteristic can vary with an excessive shock or stress.</li> <li>◆ Packing</li> <li>1. If packing boxes are accumulated, that could cause a deformation on packing tapes or a damage on the products.</li> </ul>
7. Storage conditions	
Precautions	<ul style="list-style-type: none"> <li>◆ Storage</li> <li>1. To maintain the solderability of terminal electrodes and to keep the packing material in good condition, temperature and humidity in the storage area should be controlled. <ul style="list-style-type: none"> <li>▪ Storage conditions</li> <li>Ambient temperature : <math>-5\sim 40^{\circ}\text{C}</math></li> <li>Humidity : Below 70% RH</li> <li>▪ The recommended ambient temperature is below <math>30^{\circ}\text{C}</math>. Even under ideal storage conditions, solderability of products electrodes may decrease as time passes.</li> <li>For this reason, product should be used within 6 months from the time of delivery.</li> <li>In case of storage over 6 months, solderability shall be checked before actual usage.</li> </ul> </li> </ul>
Technical considerations	<ul style="list-style-type: none"> <li>◆ Storage</li> <li>1. Under a high temperature and humidity environment, problems such as reduced solderability caused by oxidation of terminal electrodes and deterioration of taping/packaging materials may take place.</li> </ul>

## 通信基础设备 / 工业设备用途 绕线型铁氧体系功率电感器 LBQN/LBQPA 系列

系列前的记号来自型号，用来区分产品的种类和特性等。

回流焊

## ■ 型号标示法

\*使用温度范围：-40~105℃（包含产品本身发热）

L	B	Q	N	A	2	0	1	2	1	2	T	1	0	0	M		
①	②	③	④	⑤	⑥	⑦	⑧	⑨									

## ① 系列

代码 (1)(2)(3)(4)	
LBQN	通信基础设备 / 工业设备用途绕线型铁氧体系功率电感器
LBQP	通信基础设备 / 工业设备用途绕线型铁氧体系功率电感器

## (1) 产品群

代码	
L	电感器

## (2) 范畴

代码	推荐设备	品质等级
B	通信基础设备 / 工业设备	2

## (3) 类型

代码	
Q	绕线型铁氧体系 横型

## (4) 特效 / 特性

代码	
N	一般功率扼流
P	大电流功率扼流

## ② 特征

代码	特征
A	5面电极（树脂银×镀锡）

## ⑤ 包装

代码	包装
T	卷盘带装

## ③ 尺寸 (L×W)

代码	外型 (inch)	尺寸 (L×W) [mm]
2012	2012 (0805)	2.0×1.25
2016	2016 (0806)	2.0×1.6
2518	2518 (1007)	2.5×1.8
3225	3225 (1210)	3.2×2.5

## ⑥ 标称电感值

代码 (例)	标称电感值 [μH]
1R0	1.0
100	10
101	100

※R=小数点

## ④ 尺寸 (T)

代码	尺寸 (T) [mm]
12	1.25
16	1.6
18	1.8
25	2.5

## ⑦ 电感量公差

代码	电感量公差
K	±10%
M	±20%

## ⑧ 个别规格

代码	个别规格
R	低 Rdc 品

## ⑨ 管理记号



## ■ 标准外型尺寸 / 标准数量

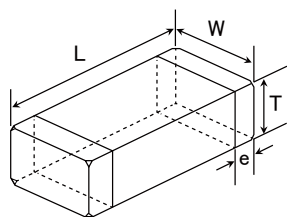

## 推荐焊盘图案

## 实装上的注意

- 请确认实装状态后使用。
- 本产品焊法限定为回流焊法。

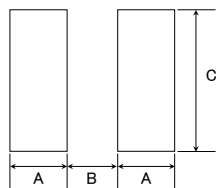

Type	A	B	C
A2012	0.60	1.0	1.45
A2016	0.60	1.0	1.8
A2518	0.60	1.5	2.0
A3225	0.85	1.7	2.7

单位: mm

Type	L	W	T	e	标准数量[pcs]	
					纸带	压模带
A201212	2.0±0.2 (0.079±0.008)	1.25±0.2 (0.049±0.008)	1.25±0.2 (0.049±0.008)	0.5±0.2 (0.020±0.008)	—	3000
A201616	2.0±0.2 (0.079±0.008)	1.6±0.2 (0.063±0.008)	1.6±0.2 (0.063±0.008)	0.5±0.2 (0.020±0.008)	—	2000
A251818	2.5±0.2 (0.098±0.008)	1.8±0.2 (0.071±0.008)	1.8±0.2 (0.071±0.008)	0.5±0.2 (0.020±0.008)	—	2000
A322525	3.2±0.2 (0.126±0.008)	2.5±0.2 (0.098±0.008)	2.5±0.2 (0.098±0.008)	0.6±0.3 (0.024±0.012)	—	1000

单位: mm (inch)

■ PART NUMBER

• All the Wire-wound Ferrite Power Inductors of the catalog lineup are RoHS compliant.

Notes)  
 • The exchange of individual specifications is necessary depending on your application and/or circuit condition. Please contact TAIYO YUDEN's official sales channel.  
 • The products are for Telecommunications infrastructure and Industrial equipment.  
 Please consult with TAIYO YUDEN's official sales channel for the details of the product specifications, etc., and please review and approve the product specifications before ordering.

● 2012 (0805) type

New part number	Old part number (for reference)	Nominal inductance [μH]	Inductance tolerance	Self-resonant frequency [MHz] (min.)	DC Resistance [Ω] (±30%)	Rated current ※) [mA]		Measuring frequency [MHz]
						Saturation current Idc1	Temperature rise current Idc2	
LBQNA201212T1R0M	CB 2012T1R0M 8	1.0	±20%	100	0.15	500	700	7.96
LBQNA201212T2R2M	CB 2012T2R2M 8	2.2	±20%	80	0.23	410	620	7.96
LBQNA201212T3R3M	CB 2012T3R3M 8	3.3	±20%	55	0.30	330	550	7.96
LBQNA201212T4R7M	CB 2012T4R7M 8	4.7	±20%	45	0.40	300	430	7.96
LBQNA201212T6R8M	CB 2012T6R8M 8	6.8	±20%	38	0.47	250	350	7.96
LBQNA201212T100K	CB 2012T100K 8	10	±10%	32	0.70	190	300	2.52
LBQNA201212T100M	CB 2012T100M 8	10	±20%	32	0.70	190	300	2.52
LBQNA201212T100KR	CB 2012T100KR8	10	±10%	32	0.50	200	300	2.52
LBQNA201212T100MR	CB 2012T100MR8	10	±20%	32	0.50	200	300	2.52
LBQNA201212T150K	CB 2012T150K 8	15	±10%	28	1.3	170	240	2.52
LBQNA201212T150M	CB 2012T150M 8	15	±20%	28	1.3	170	240	2.52
LBQNA201212T220K	CB 2012T220K 8	22	±10%	16	1.7	135	220	2.52
LBQNA201212T220M	CB 2012T220M 8	22	±20%	16	1.7	135	220	2.52
LBQNA201212T470K	CB 2012T470K 8	47	±10%	11	3.7	90	140	2.52
LBQNA201212T470M	CB 2012T470M 8	47	±20%	11	3.7	90	140	2.52
LBQNA201212T680K	CB 2012T680K 8	68	±10%	10	6.0	70	100	2.52
LBQNA201212T680M	CB 2012T680M 8	68	±20%	10	6.0	70	100	2.52
LBQNA201212T101K	CB 2012T101K 8	100	±10%	8	7.0	60	100	0.796
LBQNA201212T101M	CB 2012T101M 8	100	±20%	8	7.0	60	100	0.796

New part number	Old part number (for reference)	Nominal inductance [μH]	Inductance tolerance	Self-resonant frequency [MHz] (min.)	DC Resistance [Ω] (±30%)	Rated current ※) [mA]		Measuring frequency [MHz]
						Saturation current Idc1	Temperature rise current Idc2	
LBQPA201212T1R0M	CB C2012T1R0M 8	1.0	±20%	100	0.19	700	640	7.96
LBQPA201212T2R2M	CB C2012T2R2M 8	2.2	±20%	70	0.33	530	485	7.96
LBQPA201212T4R7M	CB C2012T4R7M 8	4.7	±20%	45	0.50	360	395	7.96
LBQPA201212T100K	CB C2012T100K 8	10	±10%	40	1.2	240	255	2.52
LBQPA201212T100M	CB C2012T100M 8	10	±20%	40	1.2	240	255	2.52
LBQPA201212T220K	CB C2012T220K 8	22	±10%	16	3.7	170	145	2.52
LBQPA201212T220M	CB C2012T220M 8	22	±20%	16	3.7	170	145	2.52
LBQPA201212T470K	CB C2012T470K 8	47	±10%	11	5.8	120	115	2.52
LBQPA201212T470M	CB C2012T470M 8	47	±20%	11	5.8	120	115	2.52

● 2016 (0806) type

New part number	Old part number (for reference)	Nominal inductance [μH]	Inductance tolerance	Self-resonant frequency [MHz] (min.)	DC Resistance [Ω] (±30%)	Rated current ※) [mA]		Measuring frequency [MHz]
						Saturation current Idc1	Temperature rise current Idc2	
LBQNA201616T1R0M	CB 2016T1R0M 8	1.0	±20%	100	0.09	600	720	7.96
LBQNA201616T1R5M	CB 2016T1R5M 8	1.5	±20%	80	0.11	550	650	7.96
LBQNA201616T2R2M	CB 2016T2R2M 8	2.2	±20%	70	0.13	510	600	7.96
LBQNA201616T3R3M	CB 2016T3R3M 8	3.3	±20%	55	0.20	400	440	7.96
LBQNA201616T4R7M	CB 2016T4R7M 8	4.7	±20%	45	0.25	340	410	7.96
LBQNA201616T6R8M	CB 2016T6R8M 8	6.8	±20%	38	0.35	300	330	7.96
LBQNA201616T100K	CB 2016T100K 8	10	±10%	32	0.50	250	270	2.52
LBQNA201616T100M	CB 2016T100M 8	10	±20%	32	0.50	250	270	2.52
LBQNA201616T150K	CB 2016T150K 8	15	±10%	28	0.70	210	220	2.52
LBQNA201616T150M	CB 2016T150M 8	15	±20%	28	0.70	210	220	2.52
LBQNA201616T220K	CB 2016T220K 8	22	±10%	16	1.0	165	190	2.52
LBQNA201616T220M	CB 2016T220M 8	22	±20%	16	1.0	165	190	2.52
LBQNA201616T330K	CB 2016T330K 8	33	±10%	14	1.7	130	140	2.52
LBQNA201616T330M	CB 2016T330M 8	33	±20%	14	1.7	130	140	2.52
LBQNA201616T470K	CB 2016T470K 8	47	±10%	11	2.4	110	120	2.52
LBQNA201616T470M	CB 2016T470M 8	47	±20%	11	2.4	110	120	2.52
LBQNA201616T680K	CB 2016T680K 8	68	±10%	10	3.0	90	110	2.52
LBQNA201616T680M	CB 2016T680M 8	68	±20%	10	3.0	90	110	2.52
LBQNA201616T101K	CB 2016T101K 8	100	±10%	8	4.5	70	90	0.796
LBQNA201616T101M	CB 2016T101M 8	100	±20%	8	4.5	70	90	0.796

※) The saturation current value (Idc1) is the DC current value having inductance decrease down to 30%. ( at 20°C)  
 ※) The temperature rise current value (Idc2) is the DC current value having temperature increase by 20°C. ( at 20°C)  
 ※) The rated current value is following either Idc1 or Idc2, which is the lower one.

▶ This catalog contains the typical specification only due to the limitation of space. When you consider the purchase of our products, please check our specification.  
 For details of each product (characteristics graph, reliability information, precautions for use, and so on), see our Web site (<http://www.ty-top.com/>).

■ PART NUMBER

New part number	Old part number (for reference)	Nominal inductance [μH]	Inductance tolerance	Self-resonant frequency [MHz] (min.)	DC Resistance [Ω] (±30%)	Rated current ※) [mA]		Measuring frequency [MHz]
						Saturation current Idc1	Temperature rise current Idc2	
LBQPA201616T1R0M	CB C2016T1R0M 8	1.0	±20%	100	0.10	1,100	885	7.96
LBQPA201616T1R5M	CB C2016T1R5M 8	1.5	±20%	80	0.15	1,000	775	7.96
LBQPA201616T2R2M	CB C2016T2R2M 8	2.2	±20%	70	0.20	750	625	7.96
LBQPA201616T3R3M	CB C2016T3R3M 8	3.3	±20%	55	0.27	600	535	7.96
LBQPA201616T4R7M	CB C2016T4R7M 8	4.7	±20%	45	0.37	550	460	7.96
LBQPA201616T6R8M	CB C2016T6R8M 8	6.8	±20%	38	0.59	450	360	7.96
LBQPA201616T100K	CB C2016T100K 8	10	±10%	32	0.82	380	305	2.52
LBQPA201616T100M	CB C2016T100M 8	10	±20%	32	0.82	380	305	2.52
LBQPA201616T150K	CB C2016T150K 8	15	±10%	28	1.2	300	255	2.52
LBQPA201616T150M	CB C2016T150M 8	15	±20%	28	1.2	300	255	2.52
LBQPA201616T220K	CB C2016T220K 8	22	±10%	16	1.8	250	205	2.52
LBQPA201616T220M	CB C2016T220M 8	22	±20%	16	1.8	250	205	2.52
LBQPA201616T330K	CB C2016T330K 8	33	±10%	14	2.8	220	165	2.52
LBQPA201616T330M	CB C2016T330M 8	33	±20%	14	2.8	220	165	2.52
LBQPA201616T470K	CB C2016T470K 8	47	±10%	11	4.3	150	130	2.52
LBQPA201616T470M	CB C2016T470M 8	47	±20%	11	4.3	150	130	2.52
LBQPA201616T680K	CB C2016T680K 8	68	±10%	10	7.0	130	105	2.52
LBQPA201616T680M	CB C2016T680M 8	68	±20%	10	7.0	130	105	2.52
LBQPA201616T101K	CB C2016T101K 8	100	±10%	8	8.0	110	95	0.796
LBQPA201616T101M	CB C2016T101M 8	100	±20%	8	8.0	110	95	0.796

● 2518(1007) type

New part number	Old part number (for reference)	Nominal inductance [μH]	Inductance tolerance	Self-resonant frequency [MHz] (min.)	DC Resistance [Ω] (±30%)	Rated current ※) [mA]		Measuring frequency [MHz]
						Saturation current Idc1	Temperature rise current Idc2	
LBQNA251818T1R0M	CB 2518T1R0M 8	1.0	±20%	100	0.06	1,200	1,250	7.96
LBQNA251818T1R5M	CB 2518T1R5M 8	1.5	±20%	80	0.07	650	1,100	7.96
LBQNA251818T2R2M	CB 2518T2R2M 8	2.2	±20%	68	0.09	510	1,000	7.96
LBQNA251818T3R3M	CB 2518T3R3M 8	3.3	±20%	54	0.11	440	900	7.96
LBQNA251818T4R7MR	CB 2518T4R7MR8	4.7	±20%	46	0.10	310	820	7.96
LBQNA251818T4R7M	CB 2518T4R7M 8	4.7	±20%	46	0.13	340	820	7.96
LBQNA251818T6R8M	CB 2518T6R8M 8	6.8	±20%	38	0.15	270	750	7.96
LBQNA251818T100K	CB 2518T100K 8	10	±10%	30	0.25	250	600	2.52
LBQNA251818T100M	CB 2518T100M 8	10	±20%	30	0.25	250	600	2.52
LBQNA251818T150K	CB 2518T150K 8	15	±10%	23	0.32	180	500	2.52
LBQNA251818T150M	CB 2518T150M 8	15	±20%	23	0.32	180	500	2.52
LBQNA251818T220K	CB 2518T220K 8	22	±10%	19	0.50	165	390	2.52
LBQNA251818T220M	CB 2518T220M 8	22	±20%	19	0.50	165	390	2.52
LBQNA251818T330K	CB 2518T330K 8	33	±10%	15	0.70	130	320	2.52
LBQNA251818T330M	CB 2518T330M 8	33	±20%	15	0.70	130	320	2.52
LBQNA251818T470K	CB 2518T470K 8	47	±10%	12	0.95	110	270	2.52
LBQNA251818T470M	CB 2518T470M 8	47	±20%	12	0.95	110	270	2.52
LBQNA251818T680K	CB 2518T680K 8	68	±10%	9.5	1.5	70	210	2.52
LBQNA251818T680M	CB 2518T680M 8	68	±20%	9.5	1.5	70	210	2.52
LBQNA251818T101K	CB 2518T101K 8	100	±10%	9.0	2.1	60	190	0.796
LBQNA251818T101M	CB 2518T101M 8	100	±20%	9.0	2.1	60	190	0.796
LBQNA251818T151K	CB 2518T151K 8	150	±10%	7.0	3.2	55	140	0.796
LBQNA251818T151M	CB 2518T151M 8	150	±20%	7.0	3.2	55	140	0.796
LBQNA251818T221K	CB 2518T221K 8	220	±10%	5.5	4.5	50	110	0.796
LBQNA251818T221M	CB 2518T221M 8	220	±20%	5.5	4.5	50	110	0.796
LBQNA251818T331K	CB 2518T331K 8	330	±10%	4.5	7.0	40	90	0.796
LBQNA251818T331M	CB 2518T331M 8	330	±20%	4.5	7.0	40	90	0.796
LBQNA251818T471K	CB 2518T471K 8	470	±10%	3.5	10	35	70	0.796
LBQNA251818T471M	CB 2518T471M 8	470	±20%	3.5	10	35	70	0.796
LBQNA251818T681K	CB 2518T681K 8	680	±10%	3.0	17	30	50	0.796
LBQNA251818T681M	CB 2518T681M 8	680	±20%	3.0	17	30	50	0.796
LBQNA251818T102K	CB 2518T102K 8	1000	±10%	2.4	24	25	45	0.252
LBQNA251818T102M	CB 2518T102M 8	1000	±20%	2.4	24	25	45	0.252

※) The saturation current value (Idc1) is the DC current value having inductance decrease down to 30%. ( at 20°C)  
 ※) The temperature rise current value (Idc2) is the DC current value having temperature increase by 20°C. ( at 20°C)  
 ※) The rated current value is following either Idc1 or Idc2, which is the lower one.

▶ This catalog contains the typical specification only due to the limitation of space. When you consider the purchase of our products, please check our specification.  
 For details of each product (characteristics graph, reliability information, precautions for use, and so on), see our Web site (<http://www.ty-top.com/>).

## PART NUMBER

New part number	Old part number (for reference)	Nominal inductance [ $\mu$ H]	Inductance tolerance	Self-resonant frequency [MHz] (min.)	DC Resistance [ $\Omega$ ] ( $\pm 30\%$ )	Rated current ※) [mA]		Measuring frequency [MHz]
						Saturation current Idc1	Temperature rise current Idc2	
LBQPA251818T1R0M	CB C2518T1R0M 8	1.0	$\pm 20\%$	100	0.08	1,000	775	7.96
LBQPA251818T1R5M	CB C2518T1R5M 8	1.5	$\pm 20\%$	80	0.11	950	730	7.96
LBQPA251818T2R2M	CB C2518T2R2M 8	2.2	$\pm 20\%$	68	0.13	890	630	7.96
LBQPA251818T3R3M	CB C2518T3R3M 8	3.3	$\pm 20\%$	54	0.16	730	560	7.96
LBQPA251818T4R7M	CB C2518T4R7M 8	4.7	$\pm 20\%$	41	0.20	680	510	7.96
LBQPA251818T6R8M	CB C2518T6R8M 8	6.8	$\pm 20\%$	38	0.30	550	420	7.96
LBQPA251818T100K	CB C2518T100K 8	10	$\pm 10\%$	30	0.36	480	375	2.52
LBQPA251818T100M	CB C2518T100M 8	10	$\pm 20\%$	30	0.36	480	375	2.52
LBQPA251818T150K	CB C2518T150K 8	15	$\pm 10\%$	23	0.65	350	285	2.52
LBQPA251818T150M	CB C2518T150M 8	15	$\pm 20\%$	23	0.65	350	285	2.52
LBQPA251818T220K	CB C2518T220K 8	22	$\pm 10\%$	19	0.77	320	250	2.52
LBQPA251818T220M	CB C2518T220M 8	22	$\pm 20\%$	19	0.77	320	250	2.52
LBQPA251818T330K	CB C2518T330K 8	33	$\pm 10\%$	15	1.5	270	185	2.52
LBQPA251818T330M	CB C2518T330M 8	33	$\pm 20\%$	15	1.5	270	185	2.52
LBQPA251818T470K	CB C2518T470K 8	47	$\pm 10\%$	12	1.9	240	165	2.52
LBQPA251818T470M	CB C2518T470M 8	47	$\pm 20\%$	12	1.9	240	165	2.52
LBQPA251818T680K	CB C2518T680K 8	68	$\pm 10\%$	9.5	2.8	200	140	2.52
LBQPA251818T680M	CB C2518T680M 8	68	$\pm 20\%$	9.5	2.8	200	140	2.52
LBQPA251818T101K	CB C2518T101K 8	100	$\pm 10\%$	9.0	3.7	160	125	0.796
LBQPA251818T101M	CB C2518T101M 8	100	$\pm 20\%$	9.0	3.7	160	125	0.796
LBQPA251818T151K	CB C2518T151K 8	150	$\pm 10\%$	7.0	6.1	140	95	0.796
LBQPA251818T151M	CB C2518T151M 8	150	$\pm 20\%$	7.0	6.1	140	95	0.796
LBQPA251818T221K	CB C2518T221K 8	220	$\pm 10\%$	5.5	8.4	115	80	0.796
LBQPA251818T221M	CB C2518T221M 8	220	$\pm 20\%$	5.5	8.4	115	80	0.796
LBQPA251818T331K	CB C2518T331K 8	330	$\pm 10\%$	4.5	12.3	100	65	0.796
LBQPA251818T331M	CB C2518T331M 8	330	$\pm 20\%$	4.5	12.3	100	65	0.796
LBQPA251818T471K	CB C2518T471K 8	470	$\pm 10\%$	3.5	22	80	50	0.796
LBQPA251818T471M	CB C2518T471M 8	470	$\pm 20\%$	3.5	22	80	50	0.796
LBQPA251818T681K	CB C2518T681K 8	680	$\pm 10\%$	3.0	28	65	45	0.796
LBQPA251818T681M	CB C2518T681M 8	680	$\pm 20\%$	3.0	28	65	45	0.796

## 3225(1210) type

New part number	Old part number (for reference)	Nominal inductance [ $\mu$ H]	Inductance tolerance	Self-resonant frequency [MHz] (min.)	DC Resistance [ $\Omega$ ] ( $\pm 30\%$ )	Rated current ※) [mA]		Measuring frequency [MHz]
						Saturation current Idc1	Temperature rise current Idc2	
LBQPA322525T1R0MR	CB C3225T1R0MR8	1.0	$\pm 20\%$	250	0.055	2,000	1,100	0.1
LBQPA322525T1R5MR	CB C3225T1R5MR8	1.5	$\pm 20\%$	220	0.060	2,000	1,000	0.1
LBQPA322525T2R2MR	CB C3225T2R2MR8	2.2	$\pm 20\%$	190	0.080	2,000	930	0.1
LBQPA322525T3R3MR	CB C3225T3R3MR8	3.3	$\pm 20\%$	160	0.095	2,000	850	0.1
LBQPA322525T4R7MR	CB C3225T4R7MR8	4.7	$\pm 20\%$	70	0.100	1,250	830	0.1
LBQPA322525T6R8MR	CB C3225T6R8MR8	6.8	$\pm 20\%$	50	0.120	950	760	0.1
LBQPA322525T100KR	CB C3225T100KR8	10	$\pm 10\%$	23	0.133	900	720	0.1
LBQPA322525T100MR	CB C3225T100MR8	10	$\pm 20\%$	23	0.133	900	720	0.1
LBQPA322525T150KR	CB C3225T150KR8	15	$\pm 10\%$	20	0.195	730	590	0.1
LBQPA322525T150MR	CB C3225T150MR8	15	$\pm 20\%$	20	0.195	730	590	0.1
LBQPA322525T220KR	CB C3225T220KR8	22	$\pm 10\%$	17	0.27	620	500	0.1
LBQPA322525T220MR	CB C3225T220MR8	22	$\pm 20\%$	17	0.27	620	500	0.1
LBQPA322525T330KR	CB C3225T330KR8	33	$\pm 10\%$	13	0.41	500	400	0.1
LBQPA322525T330MR	CB C3225T330MR8	33	$\pm 20\%$	13	0.41	500	400	0.1
LBQPA322525T470KR	CB C3225T470KR8	47	$\pm 10\%$	10	0.67	390	320	0.1
LBQPA322525T470MR	CB C3225T470MR8	47	$\pm 20\%$	10	0.67	390	320	0.1
LBQPA322525T680KR	CB C3225T680KR8	68	$\pm 10\%$	8.0	1.0	320	260	0.1
LBQPA322525T680MR	CB C3225T680MR8	68	$\pm 20\%$	8.0	1.0	320	260	0.1
LBQPA322525T101KR	CB C3225T101KR8	100	$\pm 10\%$	6.0	1.4	270	220	0.1
LBQPA322525T101MR	CB C3225T101MR8	100	$\pm 20\%$	6.0	1.4	270	220	0.1
LBQPA322525T221KR	CB C3225T221KR8	220	$\pm 10\%$	3.0	2.5	190	170	0.1
LBQPA322525T221MR	CB C3225T221MR8	220	$\pm 20\%$	3.0	2.5	190	170	0.1
LBQPA322525T821KR	CB C3225T821KR8	820	$\pm 10\%$	1.8	12	110	80	0.1
LBQPA322525T821MR	CB C3225T821MR8	820	$\pm 20\%$	1.8	12	110	80	0.1
LBQPA322525T102KR	CB C3225T102KR8	1000	$\pm 10\%$	1.6	13	100	75	0.1
LBQPA322525T102MR	CB C3225T102MR8	1000	$\pm 20\%$	1.6	13	100	75	0.1

※) The saturation current value (Idc1) is the DC current value having inductance decrease down to 30%. ( at 20°C)

※) The temperature rise current value (Idc2) is the DC current value having temperature increase by 20°C. ( at 20°C)

※) The rated current value is following either Idc1 or Idc2, which is the lower one.

Derating of Rated Current

LBQN/LBQPA series

Derating of current is necessary for LBQN/LBQPA series depending on ambient temperature. Please refer to the chart shown below for appropriate derating of current.

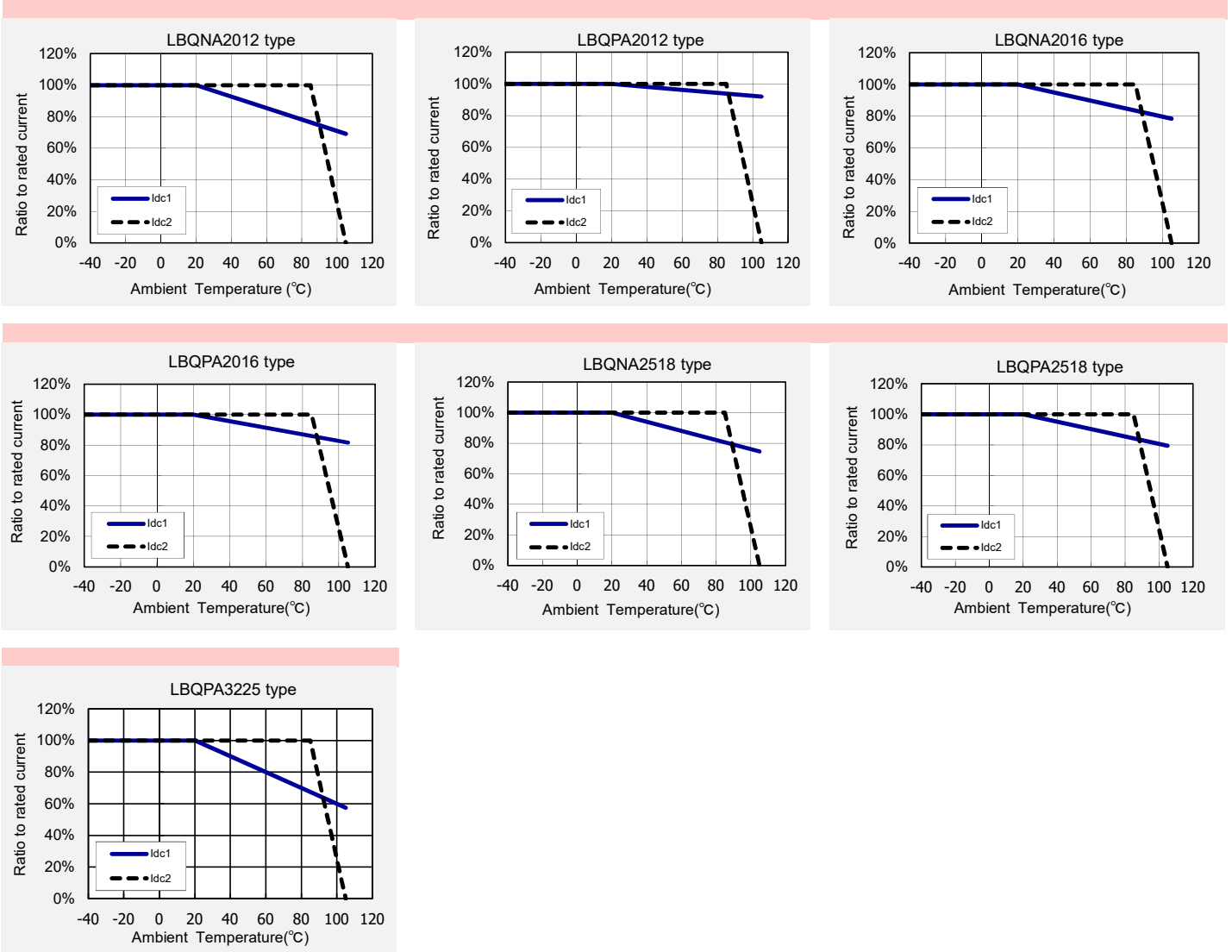

► This catalog contains the typical specification only due to the limitation of space. When you consider the purchase of our products, please check our specification. For details of each product (characteristics graph, reliability information, precautions for use, and so on), see our Web site (<http://www.ty-top.com/>).

Wire-wound Ferrite Inductors LSQB/LSQC/LSQE/LLQB/LLQC/LLQE/LMQB/LMQC/LMQE/  
LBQB/LBQC/LBQE series

Wire-wound Ferrite Power Inductors LSQN/LSQPA/LLQN/LLQPA/LMQN/LMQPA/  
LBQN/LBQPA series

Wire-wound Ferrite Inductors for Signal Lines LSQM/LLQM/LMQM/LBQM series

■ PACKAGING

① Minimum Quantity

Type	Standard Quantity [pcs]	
	Paper Tape	Embossed Tape
A322525	—	1000
A321818	—	2000
A251818	—	2000
B201616	—	2000
A201616	—	2000
A201212	—	3000
A201209	4000	—
A160808	4000	—
B160808	—	3000

② Tape material

● Embossed tape

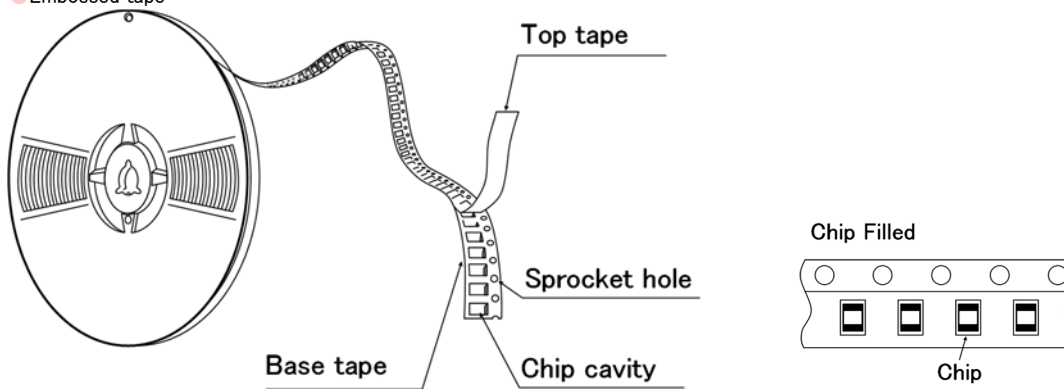

● Card board carrier tape

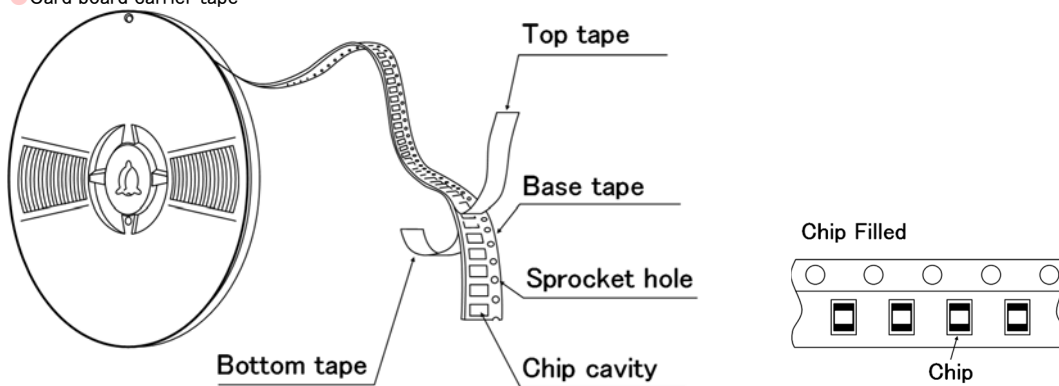

▶ This catalog contains the typical specification only due to the limitation of space. When you consider the purchase of our products, please check our specification. For details of each product (characteristics graph, reliability information, precautions for use, and so on), see our Web site (<http://www.ty-top.com/>).

### ③ Taping Dimensions

#### ● Embossed Tape (0.315 inches wide)

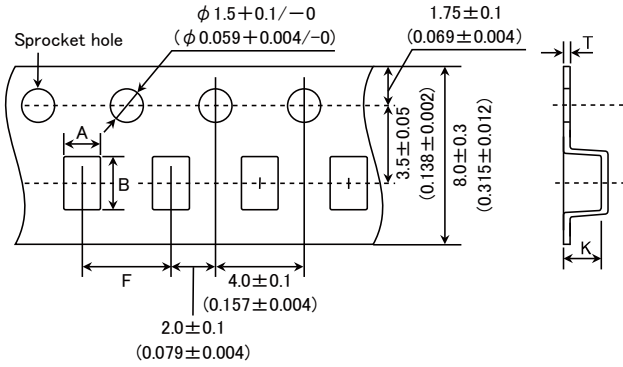

Type	Chip cavity		Insertion pitch F	Tape thickness	
	A	B		T	K
B201616	1.75±0.1 (0.069±0.004)	2.1±0.1 (0.083±0.004)	4.0±0.1 (0.157±0.004)	0.3±0.05 (0.012±0.002)	1.9max. (0.075max.)
A322525	2.8±0.1 (0.110±0.004)	3.5±0.1 (0.138±0.004)	4.0±0.1 (0.157±0.004)	0.3±0.05 (0.012±0.002)	4.0max. (0.157max.)
A321818	2.1±0.1 (0.083±0.004)	3.5±0.1 (0.138±0.004)	4.0±0.1 (0.157±0.004)	0.3±0.05 (0.012±0.002)	2.2max. (0.087max.)
A251818	2.15±0.1 (0.085±0.004)	2.7±0.1 (0.106±0.004)	4.0±0.1 (0.157±0.004)	0.3±0.05 (0.012±0.002)	2.2max. (0.087max.)
A201616	1.75±0.1 (0.069±0.004)	2.1±0.1 (0.083±0.004)	4.0±0.1 (0.157±0.004)	0.3±0.05 (0.012±0.002)	1.9max. (0.075max.)
A201212	1.45±0.1 (0.057±0.004)	2.25±0.1 (0.089±0.004)	4.0±0.1 (0.157±0.004)	0.25±0.05 (0.010±0.002)	1.45max. (0.057max.)
B160808	1.1±0.1 (0.043±0.004)	1.9±0.1 (0.075±0.004)	4.0±0.1 (0.157±0.004)	0.25±0.05 (0.010±0.002)	1.2max. (0.047max.)

Unit : mm (inch)

#### ● Card board carrier tape (0.315 inches wide)

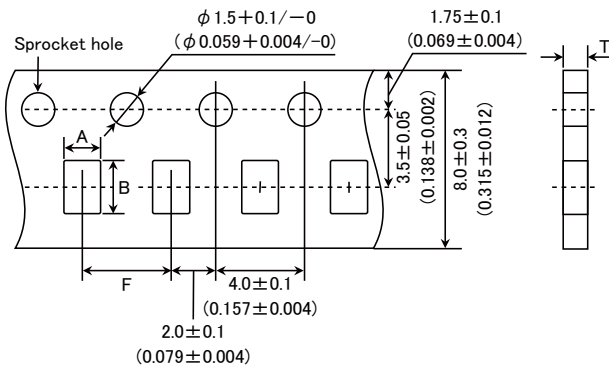

Type	Chip cavity		Insertion pitch F	Tape thickness
	A	B		T
A201209	1.55±0.1 (0.061±0.004)	2.3±0.1 (0.091±0.004)	4.0±0.1 (0.157±0.004)	1.1max. (0.043max.)
A160808	1.0±0.1 (0.039±0.004)	1.8±0.1 (0.071±0.004)	4.0±0.1 (0.157±0.004)	1.1max. (0.043max.)

Unit : mm (inch)

④ Leader and Blank Portion

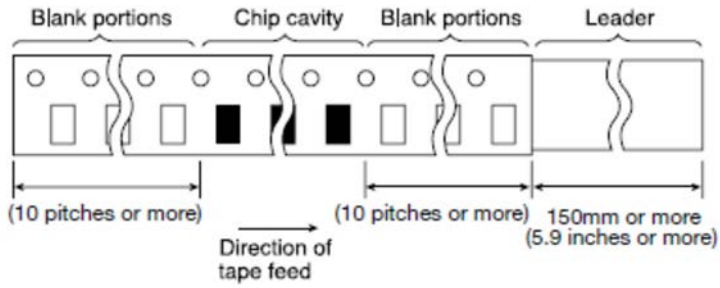

⑤ Reel Size

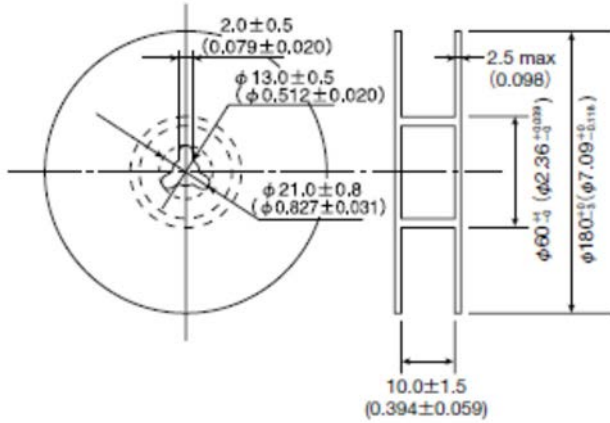

⑥ Top Tape Strength

The top tape requires a peel-off force 0.1 to 1.0N in the direction of the arrow as illustrated below.

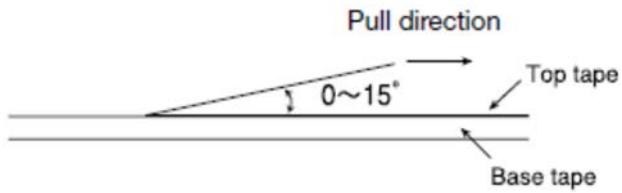

► This catalog contains the typical specification only due to the limitation of space. When you consider the purchase of our products, please check our specification. For details of each product (characteristics graph, reliability information, precautions for use, and so on), see our Web site (<http://www.ty-top.com/>).



Wire-wound Ferrite Power Inductors LBQB/LBQC/LBQE series  
for Telecommunications Infrastructure and Industrial Equipment

Wire-wound Ferrite Power Inductors LBQN/LBQPA series  
for Telecommunications Infrastructure and Industrial Equipment

Wire-wound Ferrite Inductors for Signal Lines LBQM series  
for Telecommunications Infrastructure and Industrial Equipment

Wire-wound Ferrite Power Inductors LMQB/LMQC/LMQE series  
for Medical Devices classified as GHTF Class C (Japan Class III)

Wire-wound Ferrite Power Inductors LMQN/LMQPA series  
for Medical Devices classified as GHTF Class C (Japan Class III)

Wire-wound Ferrite Inductors for Signal Lines LMQM series  
for Medical Devices classified as GHTF Class C (Japan Class III)

#### ■ RELIABILITY DATA

##### 1. Operating temperature Range

Specified Value -40~+105°C (Including self-generated heat)

Test Methods and Remarks Including self-generated heat

##### 2. Storage Temperature Range (after soldering)

Specified Value -40~+85°C

Test Methods and Remarks Wire-wound Ferrite Inductors, Wire-wound Ferrite Power Inductors:  
Please refer the term of "7. storage conditions" in precautions.

##### 3. Rated Current

Specified Value Within the specified tolerance

##### 4. Inductance

Specified Value Within the specified tolerance

Test Methods and Remarks Measuring equipment : LCR Meter (HP4285A or its equivalent)

##### 5. Q

Specified Value Wire-wound Ferrite Inductors for Signal Lines:  
Within the specified tolerance

Test Methods and Remarks Wire-wound Ferrite Inductors for Signal Lines :  
Measuring equipment : LCR Meter (HP4285A or its equivalent)

##### 6. DC Resistance

Specified Value Within the specified tolerance

Test Methods and Remarks Measuring equipment : DC Ohmmeter (HIOKI 3227 or its equivalent)

##### 7. Self-Resonant Frequency

Specified Value Within the specified tolerance

Test Methods and Remarks Measuring equipment : Impedance analyzer (HP4291A or its equivalent)

### 8. Temperature Characteristic

Specified Value	LBQMB2016				Inductance change : Within $\pm 10\%$
	LMQMB2016				
	LBQBA2012	LBQEA2012	LBQNA2012	LBQBA2016	Inductance change : Within $\pm 20\%$
	LBQNA2016	LBQBA2518	LBQEA2518	LBQNA2518	
	LBQCA3225	LBQPA3225			
	LMQBA2012	LMQEA2012	LMQNA2012	LMQBA2016	
	LMQNA2016	LMQBA2518	LMQEA2518	LMQNA2518	
	LMQCA3225	LMQPA3225			
	LBQCA2016	LBQPA2016	LBQCA2518	LBQPA2518	Inductance change : Within $\pm 25\%$
	LBQBA3218				
LMQCA2016	LMQPA2016	LMQCA2518	LMQPA2518		
LMQBA3218					
LBQCA2012	LBQPA2012			Inductance change : Within $\pm 35\%$	
LMQCA2012	LMQPA2012				
Test Methods and Remarks	Change of maximum inductance deviation in step 1-5				
	Step	Temperature ( $^{\circ}\text{C}$ )			
	1	20			
	2	-40			
	3	20 (Reference temperature)			
	4	+85 (Maximum operating temperature)			
5	20				

### 9. Resistance to Flexure of Substrate

Specified Value	No damage.
Test Methods and Remarks	Warp : 2mm Test substrate : Board according to JIS C0051 Thickness : 1.0mm
	<p>Pressing jig 10 20 R340 Board R5 45±2mm 45±2mm</p>

### 10. Body Strength

Specified Value	No damage.
Test Methods and Remarks	Applied force : 10N Duration : 10sec.

### 11. Adhesion of terminal electrode

Specified Value	No abnormality.
Test Methods and Remarks	Applied force : 10N to X and Y directions Duration : 5 sec. Test substrate : Printed board

12. Resistance to vibration	
Specified Value	Inductance change : Within $\pm 20\%$ No significant abnormality in appearance.
Test Methods and Remarks	According to JIS C5102 clause 8.2. Vibration type : A Directions : 2 hrs each in X, Y and Z directions. Total: 6 hrs Frequency range : 10 to 55 to 10 Hz (1min.) Amplitude : 1.5mm Mounting method : Soldering onto printed board Recovery : At least 2 hrs of recovery under the standard condition after the test, followed by the measurement within 48 hrs.
13. Drop test	
Specified Value	—
14. Solderability	
Specified Value	At least 90% of surface of terminal electrode is covered by new
Test Methods and Remarks	Solder temperature : $245 \pm 5^\circ\text{C}$ Duration : $5 \pm 0.5\text{sec}$ Flux : Ethanol solution with 25% of colophony
15. Resistance to soldering	
Specified Value	Inductance change : Within $\pm 20\%$
Test Methods and Remarks	3 times of reflow oven at $230^\circ\text{C}$ MIN for 40sec. with peak temperature at $260^\circ\text{C}$ for 5sec.
16. Resistance to solvent	
Specified Value	—
Test Methods and Remarks	Solvent temperature : Room temperature Type of solvent : Isopropyl alcohol Cleaning conditions : 90s. Immersion and cleaning.
17. Thermal shock	
Specified Value	Inductance change : Within $\pm 20\%$ No significant abnormality in appearance.
Test Methods and Remarks	$-40 \sim +85^\circ\text{C}$ , maintain times 30min. ,100 cycle Recovery : At least 2 hrs of recovery under the standard condition after the test, followed by the measurement within 48 hrs.
18. Damp heat life test	
Specified Value	Inductance change : Within $\pm 20\%$ No significant abnormality in appearance.
Test Methods and Remarks	Temperature : $60 \pm 2^\circ\text{C}$ Humidity : $90 \sim 95\% \text{RH}$ Duration : 1000 hrs Recovery : At least 2 hrs of recovery under the standard condition after the test, followed by the measurement within 48 hrs.
19. Loading under damp heat life test	
Specified Value	Inductance change : Within $\pm 20\%$ No significant abnormality in appearance.
Test Methods and Remarks	Temperature : $60 \pm 2^\circ\text{C}$ Humidity : $90 \sim 95\% \text{RH}$ Duration : 1000 hrs Applied current : Rated current Recovery : At least 2 hrs of recovery under the standard condition after the test, followed by the measurement within 48 hrs.

### 20.High temperature life test

Specified Value	Wire-wound Ferrite Power Inductors, Wire-wound Ferrite Inductors for Signal Lines : Inductance change : Within $\pm 20\%$ No significant abnormality in appearance
Test Methods and Remarks	Temperature : $85 \pm 2^\circ\text{C}$ Duration : 1000 hrs Recovery : At least 2 hrs of recovery under the standard condition after the test, followed by the measurement within 48 hrs.

### 21.Loading at high temperature life test

Specified Value	Wire-wound Ferrite Inductors : Inductance change : Within $\pm 20\%$ No significant abnormality in appearance
Test Methods and Remarks	Temperature : $85 \pm 2^\circ\text{C}$ Duration : 1000 hrs Applied current : Rated current Recovery : At least 2 hrs of recovery under the standard condition after the test, followed by the measurement within 48 hrs.

### 22.Low temperature life test

Specified Value	Inductance change : Within $\pm 20\%$ No significant abnormality in appearance.
Test Methods and Remarks	Temperature : $-40 \pm 2^\circ\text{C}$ Duration : 1000 hrs Recovery : At least 2 hrs of recovery under the standard condition after the test, followed by the measurement within 48 hrs.

### 23.Standard condition

Specified Value	Standard test conditions Unless specified, Ambient temperature is $20 \pm 15^\circ\text{C}$ and the Relative humidity is $65 \pm 20\%$ . If there is any doubt about the test results, further measurement shall be had within the following limits: Ambient Temperature: $20 \pm 2^\circ\text{C}$ Relative humidity: $65 \pm 5\%$ Inductance value is based on our standard measurement systems.
-----------------	---

**Wire-wound Ferrite Inductors LSQB/LSQC/LSQE/LLQB/LLQC/LLQE/LMQB/LMQC/LMQE/  
LBQB/LBQC/LBQE series**

**Wire-wound Ferrite Power Inductors LSQN/LSQPA/LLQN/LLQPA/LMQN/LMQPA/  
LBQN/LBQPA series**

**Wire-wound Ferrite Inductors for Signal Lines LSQM/LLQM/LMQM/LBQM series**

**■ PRECAUTIONS**

1. Circuit Design	
Precautions	<ul style="list-style-type: none"> <li>◆ Verification of operating environment, electrical rating and performance                             <ol style="list-style-type: none"> <li>1. A malfunction in medical equipment, spacecraft, nuclear reactors, etc. may cause serious harm to human life or have severe social ramifications. As such, any inductors to be used in such equipment may require higher safety and/or reliability considerations and should be clearly differentiated from components used in general purpose applications.</li> <li>2. When inductors are used in places where dew condensation develops and/or where corrosive gas such as hydrogen sulfide, sulfurous acid, or chlorine exists in the air, characteristic deterioration may occur. Please do not use inductors under such environmental conditions.</li> </ol> </li> <li>◆ Operating Current (Verification of Rated current)                             <ol style="list-style-type: none"> <li>1. The operating current including inrush current for inductors must always be lower than their rated values.</li> <li>2. Do not apply current in excess of the rated value because the inductance may be reduced due to the magnetic saturation effect.</li> </ol> </li> <li>◆ Temperature rise                             <p>Temperature rise of power choke coil depends on the installation condition in end products.</p> <p>Make sure that temperature rise of power choke coils in actual end products is within the specified temperature range.</p> </li> </ul>
2. PCB Design	
Precautions	<ul style="list-style-type: none"> <li>◆ Land pattern design                             <ol style="list-style-type: none"> <li>1. Please contact any of our offices for a land pattern, and refer to a recommended land pattern of a right figure or specifications.</li> </ol> </li> </ul>
Technical considerations	<p>PRECAUTIONS</p> <p>【Recommended Land Patterns】</p> <p>Surface Mounting</p> <ul style="list-style-type: none"> <li>• Mounting and soldering conditions should be checked beforehand.</li> <li>• Applicable soldering process to those products is reflow soldering only.</li> </ul>
3. Considerations for automatic placement	
Precautions	<ul style="list-style-type: none"> <li>◆ Adjustment of mounting machine                             <ol style="list-style-type: none"> <li>1. Excessive impact load should not be imposed on the products when mounting onto the PC boards.</li> <li>2. Mounting and soldering conditions should be checked beforehand.</li> </ol> </li> </ul>
Technical considerations	<ol style="list-style-type: none"> <li>1. When installing products, care should be taken not to apply distortion stress as it may deform the products.</li> </ol>
4. Soldering	
Precautions	<ul style="list-style-type: none"> <li>◆ Reflow soldering (Wire-wound Ferrite Inductors, Wire-wound Ferrite Power Inductors)                             <ol style="list-style-type: none"> <li>1. For reflow soldering with either leaded or lead-free solder, the profile specified in "point for controlling" is recommended.</li> </ol> </li> <li>◆ Recommended conditions for using a soldering iron                             <ol style="list-style-type: none"> <li>1. Put the soldering iron on the land-pattern. Soldering iron's temperature - Below 350°C Duration-3 seconds or less. The soldering iron should not come in contact with inductor directly.</li> </ol> </li> </ul>
Technical considerations	<ul style="list-style-type: none"> <li>◆ Reflow soldering (Wire-wound Ferrite Inductors, Wire-wound Ferrite Power Inductors)                             <ol style="list-style-type: none"> <li>1. Reflow profile                                     <div style="text-align: center;"> <p>The graph shows a reflow profile with the following parameters:</p> <ul style="list-style-type: none"> <li>Temperature range: 150~180°C</li> <li>Time at 150~180°C: 90±30sec</li> <li>Peak temperature: 260+0/-5°C</li> <li>Time at peak: 30±10sec</li> <li>Minimum peak temperature: 230°C min</li> <li>Cooling time: 5sec max</li> </ul> </div> </li> </ol> </li> <li>◆ Recommended conditions for using a soldering iron                             <ol style="list-style-type: none"> <li>1. Components can be damaged by excessive heat where soldering conditions exceed the specified range.</li> </ol> </li> </ul>

▶ This catalog contains the typical specification only due to the limitation of space. When you consider the purchase of our products, please check our specification. For details of each product (characteristics graph, reliability information, precautions for use, and so on), see our Web site (<http://www.ty-top.com/>).

5. Cleaning	
Precautions	<ul style="list-style-type: none"> <li>◆Cleaning conditions</li> <li>Washing by supersonic waves shall be avoided.</li> </ul>
Technical considerations	<ul style="list-style-type: none"> <li>◆Cleaning conditions</li> <li>If washed by supersonic waves, the products might be broken.</li> </ul>
6. Handling	
Precautions	<ul style="list-style-type: none"> <li>◆Handling</li> <li>1. Keep the inductors away from all magnets and magnetic objects.</li> <li>◆Breakaway PC boards (splitting along perforations)</li> <li>1. When splitting the PC board after mounting inductors, care should be taken not to give any stresses of deflection or twisting to the board.</li> <li>2. Board separation should not be done manually, but by using the appropriate devices.</li> <li>◆Mechanical considerations</li> <li>1. Please do not give the inductors any excessive mechanical shocks.</li> </ul>
Technical considerations	<ul style="list-style-type: none"> <li>◆Handling</li> <li>1. There is a case that a characteristic varies with magnetic influence.</li> <li>◆Breakaway PC boards (splitting along perforations)</li> <li>1. Planning pattern configurations and the position of products should be carefully performed to minimize stress.</li> <li>◆Mechanical considerations</li> <li>1. There is a case to be damaged by a mechanical shock.</li> </ul>
7. Storage conditions	
Precautions	<ul style="list-style-type: none"> <li>◆Storage</li> <li>1. To maintain the solderability of terminal electrodes and to keep the packing material in good condition, temperature and humidity in the storage area should be controlled. <ul style="list-style-type: none"> <li>▪ Storage conditions</li> <li>Ambient temperature : 0~40°C</li> <li>Humidity : Below 70% RH</li> <li>▪ The recommended ambient temperature is below 30°C. Even under ideal storage conditions, solderability of products electrodes may decrease as time passes.</li> <li>For this reason, product should be used within 6 months from the time of delivery.</li> <li>In case of storage over 6 months, solderability shall be checked before actual usage.</li> </ul> </li> </ul>
Technical considerations	<ul style="list-style-type: none"> <li>◆Storage</li> <li>1. Under a high temperature and humidity environment, problems such as reduced solderability caused by oxidation of terminal electrodes and deterioration of taping/packaging materials may take place.</li> </ul>