

有关敝公司产品的注意事项

请务必在使用敝公司产品之前阅读。



注意

产品目录中的记载内容

本产品目录中所记载的内容为2023年3月的内容。因产品改良等原因，可能会不经预告而变更其记载内容，或是停止供应本产品目录中所记载的产品。所以，请务必在使用前先确认最新的产品信息。

未按照本产品目录中所记载的内容或交货规格说明书使用敝公司产品的，即便其致使用设备发生损害、不良情况等时，敝公司也不承担任何责任，敬请知悉。

签署交货规格说明书

就本产品目录中所记载产品的产品规格等相关内容，敝公司备有交货规格说明书，详情请向敝公司咨询。在使用敝公司产品前请务必就交货规格说明书之内容确认并批准之。

实装前的事前评估

使用敝公司产品时，请务必事先安装到使用设备之后，在实际使用的环境下进行评估和确认。

用途的限定

1. 可以使用的设备

本产品目录中所记载的产品预设为使用于一般民用电子设备〔音像设备、办公自动化设备、家电产品、办公设备、信息通讯设备（手机、电脑等）〕以及面向本产品目录或是交货规格说明书中另行注明的设备或是敝公司另行承诺的设备的通用性，标准性用途。另外，面向下述设备的应用，敝公司也备有预设的产品系列，请参考本产品目录或是交货规格说明书的内容，使用相对应的产品。

用途	产品系列		品质等级 ^(注释3)
	对象设备 ^(注释1)	规格号 (型号标记 ^(注释2))	
车载	汽车用电子设备（控制系 / 安全系）	A	1
	汽车用电子设备（车身系 / 情报系）	C	2
工业	通信基础设备·工业设备	B	2
医疗	医疗设备（国际（GHTF）第三类）	M	2
	医疗设备（国际（GHTF）第一类、第二类）	L	3
民用	一般电子设备	S	3
	移动设备专用 ^(注释4)	E	4

注释1：基于敝公司所认知的该类设备对于电子元器件所需的一般要求规格，对于该产品系列进行的应用推荐。在讨论将各个产品系列使用在对象设备以外的设备上时，请务必事先向敝公司咨询。

注释2：在产品型号中左起第2位标注有上表中所记载的“规格号”。对于相关的详细内容，请参照有关各产品型号标示法的说明资料。

注释3：在各产品系列中，都设定了从上至下1至4的“品质等级”。另外，在未得到敝公司的事前书面承诺之前，请勿将敝公司的产品使用于相对于该产品的品质等级被设定为上位品质等级的设备。

注释4：本产品系列仅可应用于一般民用电子设备中的移动设备（智能手机、平板电脑、智能手表、掌上游戏机等）。由于其设计、规格和使用环境与面向“一般电子设备”的产品系列（规格号：S）不同，有关本产品系列的详细信息请参照交货规格说明书。另外，面向“一般电子设备”的产品系列（规格号：S）也可以应用于移动设备。

2. 需要另行确认的设备

若考虑将本产品目录中所记载的产品使用于当产品发生故障、品质不良，或是由此引起的运转失常而可能会危及生命、身体或是财产，以及有可能给社会造成深刻影响的以下设备（不包括本产品目录或是交货规格说明书中另行注明可以使用设备）等时，请务必事先向敝公司咨询。

- (1) 运输用设备（汽车驱动控制设备、火车控制设备、船舶控制设备等）
- (2) 交通信号设备
- (3) 防灾 / 保安设备
- (4) 医疗设备（国际（GHTF）第三类）
- (5) 高公共性信息通讯设备 / 信息处理设备（电话交换机、电话 / 无线 / 广播电视基站等）
- (6) 其他与上述设备有同等品质与可靠性要求的设备

3. 禁止使用的设备

请勿将敝公司产品使用于对安全性和可靠性有着极高要求的以下设备。

- (1) 航天设备（人工卫星、火箭等）
- (2) 航空设备^(注释1)
- (3) 医疗设备（国际（GHTF）第四类）、植体（体内植入型）医疗设备^(注释2)
- (4) 发电控制设备（面向核能 / 水力 / 火力发电厂等的设备）
- (5) 海底设备（海底中继设备、海中的作业设备等）
- (6) 军事设备
- (7) 其他与上述设备有同等品质与可靠性要求的设备

注释1：仅限于对航空设备的安全运行不产生直接干扰的设备 [机内娱乐设备、机内照明设备、电动座椅、餐饮设备等]，在满足敝公司另行指定的相关条件时，亦可将敝公司产品用于以上用途。在贵公司考虑将敝公司的产品用于以上用途时，请务必事先向敝公司咨询相关的信息。

注释2：包括注入人体内的部分和与此相连接的体外部分。

4. 责任的限制

未经敝公司的事先书面同意，把本产品目录中所记载的产品使用于非敝公司预设用途的设备、前述需要向敝公司咨询的设备或敝公司禁止使用的设备，从而给客户或第三方造成损害的，敝公司不承担任何责任，敬请知悉。

■ 安全设计

需将敝公司的产品使用于对安全性和可靠性要求较高的设备、电路上时，请进行充分的安全性评估和可靠性评估。另外，请通过设置保护电路、保护装置的系统，设置冗余电路不会被单一故障影响安全性的系统等失效导向安全（fail-safe）设计，确保充分的安全性。

■ 有关知识产权

本产品目录中所记载的信息是用于说明相关产品的典型操作以及相关应用。此类信息的使用不代表对于敝公司以及第三方的知识产权以及其他权利的使用许可或是不侵权保证。

■ 保证范围

敝公司产品的保证范围仅限于符合交货规格说明书中所记载的产品规格且已经交付的敝公司产品本身，由敝公司产品的故障或不良情况所诱发的损害，敝公司不承担任何责任，敬请知悉。但是，仅限于敝公司的产品作为通用性，标准性用途使用于本产品目录或是交货规格说明书中另行注明的设备，且以书面形式另行签署了交易基本合同书，品质保证协订书等时，敝公司将根据该合同等的条件提供保证。

■ 正规销售渠道

本产品目录中所记载的内容适用于从敝公司营业所、销售子公司、销售代理店（即“正规销售渠道”）购买的敝公司产品，并不适用于从其他渠道购买的敝公司产品，敬请知悉。

■ 出口时的注意事项

本产品目录中所记载的部分产品在出口时须事先确认《外汇和对外贸易法》以及美国在出口管理方面的相关法规，并办理相关手续。如有不明之处，请向敝公司咨询。

▶ 由于篇幅有限，本产品目录中只记载了有代表性的产品规格，若考虑使用敝公司产品时，请确认交货规格说明书中的详细规格。另外，有关各产品的详细信息（特性图、可靠性信息、使用时的注意事项等），请参阅敝公司网站 (<http://www.ty-top.com/>)。

医疗设备用途使用指引

敝公司对于医疗设备国际（GHTF）第一类、第二类、第三类，都准备了相应的产品系列（左起第二位的
产品型号的记号为“M”或是“L”）。因此，有意在医疗设备中采用敝公司产品时，请务必事先确认医
疗设备的国际分类，并使用相应的产品系列。

另外，敝公司并没有准备意图使用于被分类为医疗设备国际（GHTF）第四类的所有设备，以及被分类为
医疗设备国际（GHTF）第三类的植体（体内植入型）医疗设备（骨导式助听器、人工网膜系统、或是连
接人体之体外装置等），因此请不要将敝公司的产品使用于上述任何设备中。如有不明之处，请与敝公
司取得联系。

对于人体的风险		低  高			
日本	依照医药品医疗器械等法之分类 (GHTF)	第一类 一般医疗设备 (GHTF Class A) 认于发生不良情况时，对于人体产生风险的程度极低者。 【代表实例】 · 体外诊断用仪器 · 喷雾器 · 血液气体分析器 · 脉搏计 · 呼吸传感器 · 电动手术台 · 手术用照明装置 · 胆固醇分析仪 · 血型分析仪 等	第二类 管制医疗设备 (GHTF Class B) 认于发生不良情况时，对于人体产生风险的程度较低者。 【代表实例】 · 电子体温计 · 电子血压计 · 电子内视镜 · 补听器 · 心电图仪 · 核磁共振成像 (MRI) · 超声波诊断装置 · 成像诊断装置 · X射线诊断装置 · 中央监护仪 · 血氧仪 等	第三类 高度管制医疗设备 (GHTF Class C) 认于发生不良情况时，对于人体产生风险的程度较高者。 【代表实例】 · 透析机器 · 放射线治疗机器 · 输液泵 · 人工呼吸器 · 血糖监测系统 · 自动体外心脏除颤器 (AED) · 皮肤激光扫描仪 · 手术电刀 · 胰岛素泵 等	第四类 高度管制医疗设备 (GHTF Class D) 对患者的侵入性高，于发生不良情况时，可能直接危及生命危险者。 【代表实例】 · 植入式心脏起搏器 · 摄像软式血管镜 · 植入式输液泵 · 心脏用手术电刀 · 附心导管之检查装置 · 除颤器 等
		美国	FDA 分类	Class I General Controls 以医疗设备发生缺陷或故障之情况下，对病患或使用者也不会产生重大伤害或危害为前提之医疗机器。	Class II General Controls and Special Controls 可预设当医疗设备发生缺陷或故障时，对病患或使用者可能会造成伤害或产生危害之医疗机器。
中国	医疗器械监督管理条例中的分类	第一类 风险程度低，实行常规管理可以保证其安全、有效的医疗器械。	第二类 具有中度风险，需要严格控制管理以保证其安全、有效的医疗器械。	第三类 具有较高风险，需要采取特别措施严格控制管理以保证其安全、有效的医疗器械。	
产品系列的对应状况	面向医疗设备 (国际 (GHTF) 第一类、第二类) 的产品系列 (左起第二位的产品型号的记号：“L”)		面向医疗设备 (国际 (GHTF) 第三类) 的产品系列 (左起第二位的产品型号的记号：“M”)	未对应 ※注释	

※注释：即使被分类为国际分类（GHTF）第三类，植体等部分的医疗设备也仍未对应。

▶ 由于篇幅有限，本产品目录中只记载了有代表性的产品规格，若考虑使用敝公司产品时，请确认交货规格说明书中的详细规格。另外，有关各产品的详细信息(特性图、可靠性信息、使用时的注意事项等)，请参阅敝公司网站(<http://www.ty-top.com/>)。

医疗设备（国际（GHTF）第一类、第二类）用途 绕线型铁氧体系功率电感器 LLXN/LLXP 系列

系列前的记号来自型号，用来区分产品的种类和特性等。

回流焊

■ 型号标示法

*使用温度范围：-25~+120℃（LLXN 4040/5050/6060/8080：-25~+125℃）（包含产品本身发热）

L	L	X	N	D	4	0	4	0	K	K	L	1	0	0	M	D	G
①	②	③	④	⑤	⑥	⑦	⑧										

①系列

代码 (1)(2)(3)(4)	
LLXN	医疗设备（国际（GHTF）第一类、第二类）用途 绕线型铁氧体系功率电感器
LLXP	医疗设备（国际（GHTF）第一类、第二类）用途 绕线型铁氧体系功率电感器

(1) 产品群

代码	
L	电感器

(2) 范畴

代码	推荐设备	品质等级
L	医疗设备（国际（GHTF）第一类、第二类）	3

②特征

代码	特征
D	底面电极（银×焊料）
E	底面电极（铜×焊料）
H	底面电极（框型）

③尺寸（L×W）

代码	尺寸（L×W）[mm]
2020	2.0×2.0
2424	2.4×2.4
3030	3.0×3.0
4040	4.0×4.0
5050	5.0×5.0
6060	6.0×6.0
8080	8.0×8.0

④尺寸（H）

代码	尺寸（H）[mm]
KK	1.0
MK	1.2
PK	1.4
QK	1.5
TK	1.8
WK	2.0
WD	2.4
WE	2.5
WH	2.8
XK	3.0
XA	3.1
YK	4.0
YA	4.1
YB	4.2
YE	4.5

(3) 类型

代码	
X	绕线型铁氧体系 鼓型

(4) 特效 / 特性

代码	
N	一般功率扼流
P	大电流功率扼流

⑤包装

代码	包装
T	卷盘带装
L	卷盘带装

⑥标称电感值

代码（例）	标称电感值 [μH]
2R2	2.2
100	10
101	100

※R=小数点

⑦电感量公差

代码	电感量公差
M	±20%
N	±30%

⑧管理记号

▶ 由于篇幅有限，本产品目录中只记载了有代表性的产品规格，若考虑使用敝公司产品时，请确认交货规格说明书中的详细规格。
另外，有关各产品的详细信息（特性图、可靠性信息、使用时的注意事项等），请参阅敝公司网站（<http://www.ty-top.com/>）。

■标准外型尺寸 / 标准数量

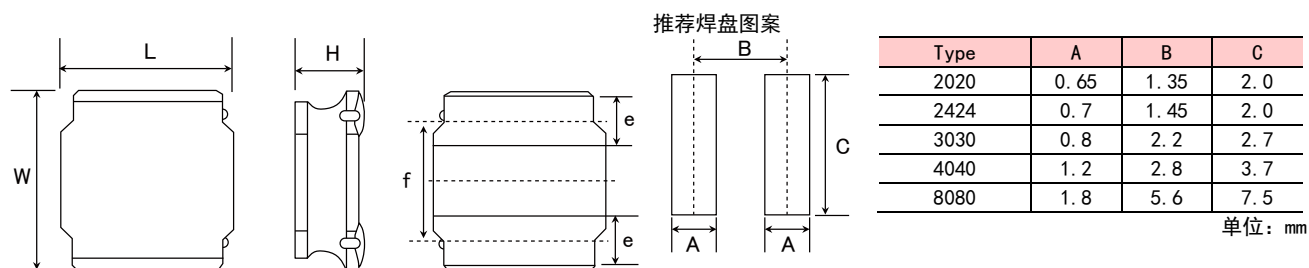

Type	L	W	H	e	f	标准数量 [pcs] 卷盘带装
2020KK	2.0±0.1 (0.079±0.004)	2.0±0.1 (0.079±0.004)	1.0 max (0.039 max)	0.5±0.2 (0.020±0.008)	1.25±0.2 (0.050±0.008)	2500
2020MK	2.0±0.1 (0.079±0.004)	2.0±0.1 (0.079±0.004)	1.2 max (0.047 max)	0.5±0.2 (0.020±0.008)	1.25±0.2 (0.050±0.008)	2500
2424KK	2.4±0.1 (0.095±0.004)	2.4±0.1 (0.095±0.004)	1.0 max (0.039 max)	0.6±0.2 (0.024±0.008)	1.45±0.2 (0.057±0.008)	2500
2424MK	2.4±0.1 (0.095±0.004)	2.4±0.1 (0.095±0.004)	1.2 max (0.047 max)	0.6±0.2 (0.024±0.008)	1.45±0.2 (0.057±0.008)	2500
3030KK	3.0±0.1 (0.118±0.004)	3.0±0.1 (0.118±0.004)	1.0 max (0.039 max)	0.9±0.2 (0.035±0.008)	1.9±0.2 (0.075±0.008)	2000
3030MK	3.0±0.1 (0.118±0.004)	3.0±0.1 (0.118±0.004)	1.2 max (0.047 max)	0.9±0.2 (0.035±0.008)	1.9±0.2 (0.075±0.008)	2000
3030QK	3.0±0.1 (0.118±0.004)	3.0±0.1 (0.118±0.004)	1.5 max (0.059 max)	0.9±0.2 (0.035±0.008)	1.9±0.2 (0.075±0.008)	2000
4040KK	4.0±0.2 (0.158±0.008)	4.0±0.2 (0.158±0.008)	1.0 max (0.039 max)	1.1±0.2 (0.043±0.008)	2.5±0.2 (0.098±0.008)	5000
4040MK	4.0±0.2 (0.158±0.008)	4.0±0.2 (0.158±0.008)	1.2 max (0.047 max)	1.1±0.2 (0.043±0.008)	2.5±0.2 (0.098±0.008)	4500
4040TK	4.0±0.2 (0.158±0.008)	4.0±0.2 (0.158±0.008)	1.8 max (0.071 max)	1.1±0.2 (0.043±0.008)	2.5±0.2 (0.098±0.008)	3500
8080XK	8.0±0.2 (0.315±0.008)	8.0±0.2 (0.315±0.008)	3.0 max (0.118 max)	1.60±0.3 (0.063±0.012)	5.6±0.3 (0.22±0.012)	1000
8080YK	8.0±0.2 (0.315±0.008)	8.0±0.2 (0.315±0.008)	4.0 max (0.158 max)	1.60±0.3 (0.063±0.012)	5.6±0.3 (0.22±0.012)	1000
8080YB	8.0±0.2 (0.315±0.008)	8.0±0.2 (0.315±0.008)	4.2 max (0.165 max)	1.60±0.3 (0.063±0.012)	5.6±0.3 (0.22±0.012)	1000

单位: mm (inch)

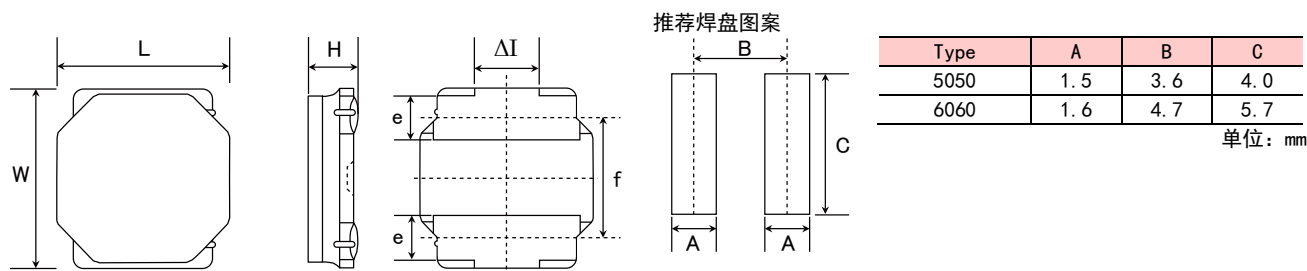

Type	L	W	H	e	f	ΔI	标准数量 [pcs] 卷盘带装
5050KK	4.9±0.2 (0.193±0.008)	4.9±0.2 (0.193±0.008)	1.0 max (0.039 max)	1.2±0.2 (0.047±0.008)	3.3±0.2 (0.130±0.008)	1.3typ (0.051typ)	1000
5050MK	4.9±0.2 (0.193±0.008)	4.9±0.2 (0.193±0.008)	1.2 max (0.047 max)	1.2±0.2 (0.047±0.008)	3.3±0.2 (0.130±0.008)	1.3typ (0.051typ)	1000
5050PK	4.9±0.2 (0.193±0.008)	4.9±0.2 (0.193±0.008)	1.4 max (0.055 max)	1.2±0.2 (0.047±0.008)	3.3±0.2 (0.130±0.008)	1.3typ (0.051typ)	1000
5050WK	4.9±0.2 (0.193±0.008)	4.9±0.2 (0.193±0.008)	2.0 max (0.079 max)	1.2±0.2 (0.047±0.008)	3.3±0.2 (0.130±0.008)	1.3typ (0.051typ)	800
5050WD	4.9±0.2 (0.193±0.008)	4.9±0.2 (0.193±0.008)	2.4 max (0.095 max)	1.2±0.2 (0.047±0.008)	3.3±0.2 (0.130±0.008)	1.3typ (0.051typ)	2500
5050WE	4.9±0.2 (0.193±0.008)	4.9±0.2 (0.193±0.008)	2.5 max (0.098 max)	1.2±0.2 (0.047±0.008)	3.3±0.2 (0.130±0.008)	1.3typ (0.051typ)	2500
5050XK	4.9±0.2 (0.193±0.008)	4.9±0.2 (0.193±0.008)	3.0 max (0.118 max)	1.2±0.2 (0.047±0.008)	3.3±0.2 (0.130±0.008)	1.3typ (0.051typ)	500
5050XA	4.9±0.2 (0.193±0.008)	4.9±0.2 (0.193±0.008)	3.1 max (0.122 max)	1.2±0.2 (0.047±0.008)	3.3±0.2 (0.130±0.008)	1.3typ (0.051typ)	500
5050YK	4.9±0.2 (0.193±0.008)	4.9±0.2 (0.193±0.008)	4.0 max (0.158 max)	1.2±0.2 (0.047±0.008)	3.3±0.2 (0.130±0.008)	1.3typ (0.051typ)	1500
5050YA	4.9±0.2 (0.193±0.008)	4.9±0.2 (0.193±0.008)	4.1 max (0.161 max)	1.2±0.2 (0.047±0.008)	3.3±0.2 (0.130±0.008)	1.3typ (0.051typ)	1500
6060KK	6.0±0.2 (0.236±0.008)	6.0±0.2 (0.236±0.008)	1.0 max (0.039 max)	1.35±0.2 (0.053±0.008)	4.0±0.2 (0.158±0.008)	2.3typ (0.091typ)	1000
6060MK	6.0±0.2 (0.236±0.008)	6.0±0.2 (0.236±0.008)	1.2 max (0.047 max)	1.35±0.2 (0.053±0.008)	4.0±0.2 (0.158±0.008)	2.3typ (0.091typ)	1000
6060PK	6.0±0.2 (0.236±0.008)	6.0±0.2 (0.236±0.008)	1.4 max (0.055 max)	1.35±0.2 (0.053±0.008)	4.0±0.2 (0.158±0.008)	2.3typ (0.091typ)	1000
6060WK	6.0±0.2 (0.236±0.008)	6.0±0.2 (0.236±0.008)	2.0 max (0.079 max)	1.35±0.2 (0.053±0.008)	4.0±0.2 (0.158±0.008)	2.3typ (0.091typ)	2500
6060WH	6.0±0.2 (0.236±0.008)	6.0±0.2 (0.236±0.008)	2.8 max (0.110 max)	1.35±0.2 (0.053±0.008)	4.0±0.2 (0.158±0.008)	2.3typ (0.091typ)	2000
6060YE	6.0±0.2 (0.236±0.008)	6.0±0.2 (0.236±0.008)	4.5 max (0.177 max)	1.35±0.2 (0.053±0.008)	4.0±0.2 (0.158±0.008)	2.3typ (0.091typ)	1500

单位: mm (inch)

■ PART NUMBER

● 2020MK type

New part number	Old part number (for reference)	EHS	Nominal inductance [μ H]	Inductance tolerance	Self-resonant frequency [MHz] (min.)	DC Resistance [Ω] ($\pm 20\%$)	Rated current ※) [mA]				Measuring frequency [kHz]
							Saturation current: Idc1		Temperature rise current: Idc2		
							Max.	Typ.	Max.	Typ.	
LLXND2020MKT1R0N0G	NRS2012T 1R0N GJ	RoHS	1.0	$\pm 30\%$	—	0.070	1,900	2,050	1,700	1,850	100
LLXND2020MKT1R5N0G	NRS2012T 1R5N GJ	RoHS	1.5	$\pm 30\%$	—	0.090	1,650	1,800	1,500	1,650	100
LLXND2020MKT2R2M0G	NRS2012T 2R2M GJ	RoHS	2.2	$\pm 20\%$	—	0.107	1,350	1,500	1,370	1,500	100
LLXND2020MKT3R3M0G	NRS2012T 3R3M GJ	RoHS	3.3	$\pm 20\%$	—	0.190	1,000	1,150	1,020	1,100	100
LLXND2020MKT4R7M0G	NRS2012T 4R7M GJ	RoHS	4.7	$\pm 20\%$	—	0.241	900	1,050	910	1,000	100

● 2020KK type

New part number	Old part number (for reference)	EHS	Nominal inductance [μ H]	Inductance tolerance	Self-resonant frequency [MHz] (min.)	DC Resistance [Ω] ($\pm 20\%$)	Rated current ※) [mA]				Measuring frequency [kHz]
							Saturation current: Idc1		Temperature rise current: Idc2		
							Max.	Typ.	Max.	Typ.	
LLXPD2020KKT4R7N0G	NRV2010T R47N GF	RoHS	0.47	$\pm 30\%$	—	0.052	2,100	2,250	2,000	2,300	100
LLXPD2020KKT6R8N0G	NRV2010T R68N GF	RoHS	0.68	$\pm 30\%$	—	0.060	1,850	2,000	1,850	2,100	100
LLXPD2020KKT1R0N0G	NRV2010T 1R0N GF	RoHS	1.0	$\pm 30\%$	—	0.080	1,550	1,700	1,600	1,850	100
LLXPD2020KKT1R5M0G	NRV2010T 1R5M GF	RoHS	1.5	$\pm 20\%$	—	0.100	1,350	1,450	1,450	1,650	100
LLXPD2020KKT2R2M0G	NRV2010T 2R2M GF	RoHS	2.2	$\pm 20\%$	—	0.175	1,100	1,200	1,100	1,200	100
LLXPD2020KKT3R3M0G	NRV2010T 3R3M GF	RoHS	3.3	$\pm 20\%$	—	0.250	880	950	1,000	1,100	100
LLXPD2020KKT4R7M0G	NRV2010T 4R7M GF	RoHS	4.7	$\pm 20\%$	—	0.320	760	810	820	930	100

● 2020MK type

New part number	Old part number (for reference)	EHS	Nominal inductance [μ H]	Inductance tolerance	Self-resonant frequency [MHz] (min.)	DC Resistance [Ω] ($\pm 20\%$)	Rated current ※) [mA]				Measuring frequency [kHz]
							Saturation current: Idc1		Temperature rise current: Idc2		
							Max.	Typ.	Max.	Typ.	
LLXPD2020MKT1R0N0G	NRV2012T 1R0N GF	RoHS	1.0	$\pm 30\%$	—	0.073	2,200	2,350	1,650	1,830	100
LLXPD2020MKT1R5N0G	NRV2012T 1R5N GF	RoHS	1.5	$\pm 30\%$	—	0.100	1,800	1,950	1,400	1,550	100
LLXPD2020MKT2R2M0G	NRV2012T 2R2M GF	RoHS	2.2	$\pm 20\%$	—	0.129	1,600	1,700	1,200	1,350	100
LLXPD2020MKT3R3M0G	NRV2012T 3R3M GF	RoHS	3.3	$\pm 20\%$	—	0.227	1,250	1,350	900	1,040	100
LLXPD2020MKT4R7M0G	NRV2012T 4R7M GF	RoHS	4.7	$\pm 20\%$	—	0.325	1,100	1,150	750	850	100

● 2424KK type

New part number	Old part number (for reference)	EHS	Nominal inductance [μ H]	Inductance tolerance	Self-resonant frequency [MHz] (min.)	DC Resistance [Ω] ($\pm 20\%$)	Rated current ※) [mA]				Measuring frequency [kHz]
							Saturation current: Idc1		Temperature rise current: Idc2		
							Max.	Typ.	Max.	Typ.	
LLXNE2424KKT6R8NN	NRH2410T R68NN 4	RoHS	0.68	$\pm 30\%$	120	0.060	2,200	2,300	1,570	1,810	100
LLXNE2424KKT1R0NN	NRH2410T 1R0NN 4	RoHS	1.0	$\pm 30\%$	106	0.070	1,800	1,950	1,410	1,640	100
LLXNE2424KKT1R5MN	NRH2410T 1R5MN	RoHS	1.5	$\pm 20\%$	94	0.110	1,550	1,640	1,160	1,320	100
LLXNE2424KKT2R2MN	NRH2410T 2R2MN	RoHS	2.2	$\pm 20\%$	77	0.150	1,290	1,340	970	1,110	100
LLXNE2424KKT3R3MN	NRH2410T 3R3MN	RoHS	3.3	$\pm 20\%$	56	0.220	1,000	1,140	770	890	100
LLXNE2424KKT4R7MN	NRH2410T 4R7MN	RoHS	4.7	$\pm 20\%$	50	0.290	880	930	670	780	100
LLXNE2424KKT6R8MN	NRH2410T 6R8MN	RoHS	6.8	$\pm 20\%$	43	0.410	750	765	570	650	100
LLXNE2424KKT100MN	NRH2410T 100MN	RoHS	10	$\pm 20\%$	32	0.690	550	605	450	520	100
LLXNE2424KKT150MN	NRH2410T 150MN	RoHS	15	$\pm 20\%$	27	1.02	470	520	370	430	100
LLXNE2424KKT220MN	NRH2410T 220MN	RoHS	22	$\pm 20\%$	22	1.47	390	405	300	340	100

● 2424MK type

New part number	Old part number (for reference)	EHS	Nominal inductance [μ H]	Inductance tolerance	Self-resonant frequency [MHz] (min.)	DC Resistance [Ω] ($\pm 20\%$)	Rated current ※) [mA]				Measuring frequency [kHz]
							Saturation current: Idc1		Temperature rise current: Idc2		
							Max.	Typ.	Max.	Typ.	
LLXNE2424MKT4R7NNG	NRH2412T R47NNGJ	RoHS	0.47	$\pm 30\%$	180	0.050	2,900	3,690	2,100	2,300	100
LLXNE2424MKT1R0NNG	NRH2412T 1R0NNGH	RoHS	1.0	$\pm 30\%$	101	0.077	2,350	2,610	1,300	1,540	100
LLXNE2424MKT1R5NNG	NRH2412T 1R5NNGH	RoHS	1.5	$\pm 30\%$	89	0.100	2,100	2,290	1,150	1,390	100
LLXNE2424MKT2R2MNG	NRH2412T 2R2MNGH	RoHS	2.2	$\pm 20\%$	72	0.140	1,700	1,940	1,000	1,190	100
LLXNE2424MKT3R3MNG	NRH2412T 3R3MNGH	RoHS	3.3	$\pm 20\%$	56	0.225	1,400	1,600	750	890	100
LLXNE2424MKT4R7MNG	NRH2412T 4R7MNGH	RoHS	4.7	$\pm 20\%$	45	0.300	1,150	1,280	650	770	100
LLXNE2424MKT6R8MNG	NRH2412T 6R8MNGH	RoHS	6.8	$\pm 20\%$	34	0.420	950	1,100	550	635	100
LLXNE2424MKT100MNG	NRH2412T 100MNGH	RoHS	10	$\pm 20\%$	29	0.600	810	900	450	510	100

● 3030KK type

New part number	Old part number (for reference)	EHS	Nominal inductance [μ H]	Inductance tolerance	Self-resonant frequency [MHz] (min.)	DC Resistance [Ω] ($\pm 20\%$)	Rated current ※) [mA]				Measuring frequency [kHz]
							Saturation current: Idc1		Temperature rise current: Idc2		
							Max.	Typ.	Max.	Typ.	
LLXNE3030KKT1R2NN	NRH3010T 1R2NN	RoHS	1.2	$\pm 30\%$	120	0.065	1,700	1,740	1,480	1,850	100
LLXNE3030KKT1R5NN	NRH3010T 1R5NN	RoHS	1.5	$\pm 30\%$	99	0.075	1,440	1,500	1,370	1,680	100
LLXNE3030KKT2R2MN	NRH3010T 2R2MN	RoHS	2.2	$\pm 20\%$	86	0.083	1,300	1,400	1,300	1,550	100
LLXNE3030KKT3R3MN	NRH3010T 3R3MN	RoHS	3.3	$\pm 20\%$	64	0.130	1,000	1,020	1,030	1,220	100
LLXNE3030KKT4R7MN	NRH3010T 4R7MN	RoHS	4.7	$\pm 20\%$	50	0.170	850	930	900	1,090	100
LLXNE3030KKT6R8MN	NRH3010T 6R8MN	RoHS	6.8	$\pm 20\%$	44	0.250	700	750	745	920	100
LLXNE3030KKT100MN	NRH3010T 100MN	RoHS	10	$\pm 20\%$	34	0.350	600	650	620	780	100
LLXNE3030KKT150MN	NRH3010T 150MN	RoHS	15	$\pm 20\%$	25	0.550	450	520	480	600	100
LLXNE3030KKT220MN	NRH3010T 220MN	RoHS	22	$\pm 20\%$	22	0.770	380	440	410	510	100
LLXNE3030KKT330MN	NRH3010T 330MN	RoHS	33	$\pm 20\%$	20	1.250	290	360	350	440	100
LLXNE3030KKT470MN	NRH3010T 470MN	RoHS	47	$\pm 20\%$	17	2.050	250	300	285	320	100

※) The saturation current value (Idc1) is the DC current value having inductance decrease down to 30%. (at 20°C)

※) The temperature rise current value (Idc2) is the DC current value having temperature increase up to 40°C. (at 20°C)

※) The rated current is the DC current value that satisfies both of current value saturation current value and temperature rise current value.

■ PART NUMBER

● 3030MK type

New part number	Old part number (for reference)	EHS	Nominal inductance [μ H]	Inductance tolerance	Self-resonant frequency [MHz] (min.)	DC Resistance [Ω] ($\pm 20\%$)	Rated current ※) [mA]				Measuring frequency [kHz]
							Saturation current: Idc1		Temperature rise current: Idc2		
							Max.	Typ.	Max.	Typ.	
LLXNE3030MKT47NN	NRH3012T R47NN	RoHS	0.47	$\pm 30\%$	160	0.033	2,600	3,200	1,900	2,280	100
LLXNE3030MKT1R0NN	NRH3012T 1R0NN	RoHS	1.0	$\pm 30\%$	111	0.048	2,200	2,500	1,710	1,970	100
LLXNE3030MKT1R5NN	NRH3012T 1R5NN	RoHS	1.5	$\pm 30\%$	95	0.055	1,700	1,900	1,600	1,750	100
LLXNE3030MKT2R2MN	NRH3012T 2R2MN	RoHS	2.2	$\pm 20\%$	78	0.075	1,500	1,750	1,370	1,600	100
LLXNE3030MKT3R3MN	NRH3012T 3R3MN	RoHS	3.3	$\pm 20\%$	61	0.100	1,200	1,500	1,210	1,480	100
LLXNE3030MKT4R7MN	NRH3012T 4R7MN	RoHS	4.7	$\pm 20\%$	50	0.130	1,000	1,200	1,060	1,280	100
LLXNE3030MKT6R8MN	NRH3012T 6R8MN	RoHS	6.8	$\pm 20\%$	43	0.190	850	910	890	1,000	100
LLXNE3030MKT100MN	NRH3012T 100MN	RoHS	10	$\pm 20\%$	32	0.270	730	780	720	850	100
LLXNE3030MKT150MN	NRH3012T 150MN	RoHS	15	$\pm 20\%$	26	0.450	530	650	570	680	100
LLXNE3030MKT220MN	NRH3012T 220MN	RoHS	22	$\pm 20\%$	22	0.630	500	550	500	590	100
LLXNE3030MKT330MN	NRH3012T 330MN	RoHS	33	$\pm 20\%$	18	0.960	360	430	450	510	100
LLXNE3030MKT470MN	NRH3012T 470MN	RoHS	47	$\pm 20\%$	16	1.340	280	380	380	430	100

● 3030MK type

New part number	Old part number (for reference)	EHS	Nominal inductance [μ H]	Inductance tolerance	Self-resonant frequency [MHz] (min.)	DC Resistance [Ω] ($\pm 20\%$)	Rated current ※) [mA]				Measuring frequency [kHz]
							Saturation current: Idc1		Temperature rise current: Idc2		
							Max.	Typ.	Max.	Typ.	
LLXPD3030MKT1R0N	NRV3012T 1R0N	RoHS	1.0	$\pm 30\%$	110	0.065	2,500	3,000	1,600	1,970	100
LLXPD3030MKT1R5N	NRV3012T 1R5N	RoHS	1.5	$\pm 30\%$	92	0.075	2,100	2,500	1,400	1,610	100
LLXPD3030MKT2R2M	NRV3012T 2R2M	RoHS	2.2	$\pm 20\%$	70	0.120	1,800	2,100	1,100	1,330	100
LLXPD3030MKT3R3M	NRV3012T 3R3M	RoHS	3.3	$\pm 20\%$	55	0.150	1,600	1,900	1,000	1,260	100
LLXPD3030MKT4R7M	NRV3012T 4R7M	RoHS	4.7	$\pm 20\%$	48	0.190	1,250	1,500	850	1,040	100
LLXPD3030MKT6R8M	NRV3012T 6R8M	RoHS	6.8	$\pm 20\%$	40	0.300	950	1,200	650	800	100
LLXPD3030MKT100M	NRV3012T 100M	RoHS	10	$\pm 20\%$	32	0.470	800	990	550	640	100

● 3030QK type

New part number	Old part number (for reference)	EHS	Nominal inductance [μ H]	Inductance tolerance	Self-resonant frequency [MHz] (min.)	DC Resistance [Ω] ($\pm 20\%$)	Rated current ※) [mA]				Measuring frequency [kHz]
							Saturation current: Idc1		Temperature rise current: Idc2		
							Max.	Typ.	Max.	Typ.	
LLXND3030QKT1R0NNG	NRS3015T 1R0NNGH	RoHS	1.0	$\pm 30\%$	100	0.030	2,100	2,400	2,100	2,350	100
LLXND3030QKT1R5NNG	NRS3015T 1R5NNGH	RoHS	1.5	$\pm 30\%$	87	0.038	1,800	2,100	1,820	2,100	100
LLXND3030QKT2R2MNG	NRS3015T 2R2MNGH	RoHS	2.2	$\pm 20\%$	64	0.058	1,480	1,700	1,500	1,800	100
LLXND3030QKT3R3MNG	NRS3015T 3R3MNGH	RoHS	3.3	$\pm 20\%$	49	0.078	1,210	1,400	1,230	1,500	100
LLXND3030QKT4R7MNG	NRS3015T 4R7MNGH	RoHS	4.7	$\pm 20\%$	40	0.120	1,020	1,100	1,040	1,300	100
LLXND3030QKT6R8MNG	NRS3015T 6R8MNGH	RoHS	6.8	$\pm 20\%$	36	0.160	870	920	880	1,100	100
LLXND3030QKT100MNG	NRS3015T 100MNGH	RoHS	10	$\pm 20\%$	28	0.220	700	750	710	840	100
LLXND3030QKT150MNG	NRS3015T 150MNGH	RoHS	15	$\pm 20\%$	23	0.325	580	680	680	760	100
LLXND3030QKT220MNG	NRS3015T 220MNGH	RoHS	22	$\pm 20\%$	20	0.520	470	540	470	530	100
LLXND3030QKT330MNG	NRS3015T 330MNGH	RoHS	33	$\pm 20\%$	18	0.780	400	440	440	490	100
LLXND3030QKT470MNG	NRS3015T 470MNGH	RoHS	47	$\pm 20\%$	17	1.100	325	380	350	380	100

● 4040KK type

New part number	Old part number (for reference)	EHS	Nominal inductance [μ H]	Inductance tolerance	Self-resonant frequency [MHz] (min.)	DC Resistance [Ω] ($\pm 20\%$)	Rated current ※) [mA]				Measuring frequency [kHz]
							Saturation current: Idc1		Temperature rise current: Idc2		
							Max.	Typ.	Max.	Typ.	
LLXND4040KKL1R0NDG	NRS4010T 1R0NDGG	RoHS	1.0	$\pm 30\%$	116	0.056	2,000	2,280	1,900	2,390	100
LLXND4040KKL2R2MDG	NRS4010T 2R2MDGG	RoHS	2.2	$\pm 20\%$	73	0.085	1,200	1,610	1,500	1,800	100
LLXND4040KKL3R3MDG	NRS4010T 3R3MDGG	RoHS	3.3	$\pm 20\%$	58	0.100	1,100	1,300	1,400	1,700	100
LLXND4040KKL4R7MDG	NRS4010T 4R7MDGG	RoHS	4.7	$\pm 20\%$	47	0.140	950	1,100	1,200	1,450	100
LLXND4040KKL6R8MDG	NRS4010T 6R8MDGG	RoHS	6.8	$\pm 20\%$	38	0.200	800	890	1,000	1,200	100
LLXND4040KKL100MDG	NRS4010T 100MDGG	RoHS	10	$\pm 20\%$	31	0.300	620	760	750	860	100
LLXND4040KKL150MDG	NRS4010T 150MDGG	RoHS	15	$\pm 20\%$	24	0.430	540	635	600	700	100
LLXND4040KKL220MDG	NRS4010T 220MDGG	RoHS	22	$\pm 20\%$	19	0.570	450	540	500	600	100
LLXND4040KKL330MDG	NRS4010T 330MDGG	RoHS	33	$\pm 20\%$	15	0.900	350	440	400	460	100
LLXND4040KKL470MDG	NRS4010T 470MDGG	RoHS	47	$\pm 20\%$	13	1.250	300	350	350	370	100

● 4040MK type

New part number	Old part number (for reference)	EHS	Nominal inductance [μ H]	Inductance tolerance	Self-resonant frequency [MHz] (min.)	DC Resistance [Ω] ($\pm 20\%$)	Rated current ※) [mA]				Measuring frequency [kHz]
							Saturation current: Idc1		Temperature rise current: Idc2		
							Max.	Typ.	Max.	Typ.	
LLXND4040MKL1R0NDG	NRS4012T 1R0NDGG	RoHS	1.0	$\pm 30\%$	100	0.042	2,800	2,900	2,200	2,670	100
LLXND4040MKL1R5NDG	NRS4012T 1R5NDGG	RoHS	1.5	$\pm 30\%$	90	0.051	2,300	2,500	2,000	2,430	100
LLXND4040MKL2R2MDG	NRS4012T 2R2MDGJ	RoHS	2.2	$\pm 20\%$	70	0.060	1,650	1,950	1,900	2,100	100
LLXND4040MKL3R3MDG	NRS4012T 3R3MDGJ	RoHS	3.3	$\pm 20\%$	60	0.070	1,400	1,700	1,700	1,880	100
LLXND4040MKL4R7MDG	NRS4012T 4R7MDGJ	RoHS	4.7	$\pm 20\%$	45	0.095	1,200	1,320	1,500	1,570	100
LLXND4040MKL6R8MDG	NRS4012T 6R8MDGJ	RoHS	6.8	$\pm 20\%$	35	0.125	900	1,170	1,300	1,400	100
LLXND4040MKL100MDG	NRS4012T 100MDGJ	RoHS	10	$\pm 20\%$	30	0.170	800	990	1,100	1,200	100
LLXND4040MKL150MDG	NRS4012T 150MDGJ	RoHS	15	$\pm 20\%$	24	0.260	650	820	750	840	100
LLXND4040MKL220MDG	NRS4012T 220MDGJ	RoHS	22	$\pm 20\%$	18	0.400	500	620	620	650	100
LLXND4040MKL330MDG	NRS4012T 330MDGJ	RoHS	33	$\pm 20\%$	15	0.600	400	500	480	530	100
LLXND4040MKL470MDG	NRS4012T 470MDGJ	RoHS	47	$\pm 20\%$	12	0.770	350	430	420	470	100

※) The saturation current value (Idc1) is the DC current value having inductance decrease down to 30%. (at 20°C)

※) The temperature rise current value (Idc2) is the DC current value having temperature increase up to 40°C. (at 20°C)

※) The rated current is the DC current value that satisfies both of current value saturation current value and temperature rise current value.

■ PART NUMBER

● 4040TK type

New part number	Old part number (for reference)	EHS	Nominal inductance [μ H]	Inductance tolerance	Self-resonant frequency [MHz] (min.)	DC Resistance [Ω] ($\pm 20\%$)	Rated current ※) [mA]				Measuring frequency [kHz]
							Saturation current: Idc1		Temperature rise current: Idc2		
							Max.	Typ.	Max.	Typ.	
LLXND4040TKL1R0NDG	NRS4018T 1R0NDGJ	RoHS	1.0	$\pm 30\%$	90	0.027	4,000	4,590	3,200	3,720	100
LLXND4040TKL1R5NDG	NRS4018T 1R5NDGJ	RoHS	1.5	$\pm 30\%$	75	0.037	3,300	3,750	2,400	3,000	100
LLXND4040TKL2R2MDG	NRS4018T 2R2MDGJ	RoHS	2.2	$\pm 20\%$	60	0.042	3,000	3,110	2,200	2,590	100
LLXND4040TKL3R3MDG	NRS4018T 3R3MDGJ	RoHS	3.3	$\pm 20\%$	45	0.055	2,300	2,560	2,000	2,240	100
LLXND4040TKL4R7MDG	NRS4018T 4R7MDGJ	RoHS	4.7	$\pm 20\%$	35	0.070	2,000	2,330	1,700	1,880	100
LLXND4040TKL6R8MDG	NRS4018T 6R8MDGJ	RoHS	6.8	$\pm 20\%$	30	0.098	1,600	1,820	1,450	1,690	100
LLXND4040TKL100MDG	NRS4018T 100MDGJ	RoHS	10	$\pm 20\%$	25	0.150	1,300	1,440	1,200	1,250	100
LLXND4040TKL150MDG	NRS4018T 150MDGJ	RoHS	15	$\pm 20\%$	18	0.210	1,100	1,150	850	915	100
LLXND4040TKL220MDG	NRS4018T 220MDGJ	RoHS	22	$\pm 20\%$	15	0.290	900	920	720	810	100
LLXND4040TKL330MDG	NRS4018T 330MDGJ	RoHS	33	$\pm 20\%$	12	0.460	700	830	550	630	100
LLXND4040TKL470MDG	NRS4018T 470MDGJ	RoHS	47	$\pm 20\%$	10	0.650	600	700	440	520	100
LLXND4040TKL680MDG	NRS4018T 680MDGJ	RoHS	68	$\pm 20\%$	8.3	1.00	520	600	320	400	100
LLXND4040TKL101MDG	NRS4018T 101MDGJ	RoHS	100	$\pm 20\%$	6.5	1.45	420	490	280	330	100
LLXND4040TKL151MDG	NRS4018T 151MDGJ	RoHS	150	$\pm 20\%$	5.5	2.30	340	390	220	280	100
LLXND4040TKL221MDG	NRS4018T 221MDGJ	RoHS	220	$\pm 20\%$	4.0	3.80	275	310	170	210	100

● 5050KK type

New part number	Old part number (for reference)	EHS	Nominal inductance [μ H]	Inductance tolerance	Self-resonant frequency [MHz] (min.)	DC Resistance [Ω] ($\pm 20\%$)	Rated current ※) [mA]				Measuring frequency [kHz]
							Saturation current: Idc1		Temperature rise current: Idc2		
							Max.	Typ.	Max.	Typ.	
LLXND5050KKT1R0NMG	NRS5010T 1R0NMGF	RoHS	1.0	$\pm 30\%$	95	0.070	2,350	2,510	1,750	2,000	100
LLXND5050KKT2R2NMG	NRS5010T 2R2NMGF	RoHS	2.2	$\pm 30\%$	65	0.105	1,500	1,710	1,400	1,600	100
LLXND5050KKT3R3MMG	NRS5010T 3R3MMGF	RoHS	3.3	$\pm 20\%$	42	0.125	1,400	1,530	1,250	1,520	100
LLXND5050KKT4R7MMG	NRS5010T 4R7MMGF	RoHS	4.7	$\pm 20\%$	37	0.145	1,200	1,340	1,150	1,390	100
LLXND5050KKT6R8MMG	NRS5010T 6R8MMGF	RoHS	6.8	$\pm 20\%$	33	0.185	1,000	1,120	1,000	1,210	100
LLXND5050KKT100MMG	NRS5010T 100MMGF	RoHS	10	$\pm 20\%$	23	0.250	850	970	900	950	100
LLXND5050KKT150MMG	NRS5010T 150MMGF	RoHS	15	$\pm 20\%$	19	0.400	680	740	650	700	100
LLXND5050KKT220MMG	NRS5010T 220MMGF	RoHS	22	$\pm 20\%$	15	0.600	550	620	450	560	100

● 5050MK type

New part number	Old part number (for reference)	EHS	Nominal inductance [μ H]	Inductance tolerance	Self-resonant frequency [MHz] (min.)	DC Resistance [Ω] ($\pm 20\%$)	Rated current ※) [mA]				Measuring frequency [kHz]
							Saturation current: Idc1		Temperature rise current: Idc2		
							Max.	Typ.	Max.	Typ.	
LLXND5050MKT1R0NMG	NRS5012T 1R0NMGF	RoHS	1.0	$\pm 30\%$	100	0.053	4,500	4,670	2,300	2,750	100
LLXND5050MKT1R5NMG	NRS5012T 1R5NMGF	RoHS	1.5	$\pm 30\%$	86	0.070	3,800	3,970	2,200	2,470	100
LLXND5050MKT2R2MMG	NRS5012T 2R2MMGF	RoHS	2.2	$\pm 20\%$	70	0.085	3,100	3,510	2,000	2,300	100
LLXND5050MKT3R3MMG	NRS5012T 3R3MMGF	RoHS	3.3	$\pm 20\%$	48	0.160	2,400	2,580	1,450	1,650	100
LLXND5050MKT4R7MMG	NRS5012T 4R7MMGF	RoHS	4.7	$\pm 20\%$	40	0.180	2,200	2,320	1,400	1,560	100
LLXND5050MKT6R8MMG	NRS5012T 6R8MMGF	RoHS	6.8	$\pm 20\%$	36	0.260	1,700	1,950	1,100	1,260	100
LLXND5050MKT100MMG	NRS5012T 100MMGF	RoHS	10	$\pm 20\%$	26	0.420	1,400	1,550	850	1,000	100
LLXND5050MKT150MMG	NRS5012T 150MMGF	RoHS	15	$\pm 20\%$	22	0.670	1,200	1,240	640	740	100

● 5050PK type

New part number	Old part number (for reference)	EHS	Nominal inductance [μ H]	Inductance tolerance	Self-resonant frequency [MHz] (min.)	DC Resistance [Ω] ($\pm 20\%$)	Rated current ※) [mA]				Measuring frequency [kHz]
							Saturation current: Idc1		Temperature rise current: Idc2		
							Max.	Typ.	Max.	Typ.	
LLXND5050PKTR47NMG	NRS5014T R47NMGJ	RoHS	0.47	$\pm 30\%$	185	0.025	5,800	6,400	3,300	3,470	100
LLXND5050PKT1R2NMG	NRS5014T 1R2NMGJ	RoHS	1.2	$\pm 30\%$	86	0.045	3,800	4,200	2,400	3,000	100
LLXND5050PKT2R2NMG	NRS5014T 2R2NMGJ	RoHS	2.2	$\pm 30\%$	56	0.065	2,800	3,100	2,000	2,400	100
LLXND5050PKT3R3NMG	NRS5014T 3R3NMGJ	RoHS	3.3	$\pm 30\%$	48	0.080	2,350	2,650	1,700	2,200	100
LLXND5050PKT4R7NMG	NRS5014T 4R7NMGJ	RoHS	4.7	$\pm 30\%$	41	0.100	2,050	2,400	1,400	1,900	100
LLXND5050PKT6R8NMG	NRS5014T 6R8NMGJ	RoHS	6.8	$\pm 20\%$	37	0.150	1,600	1,850	1,200	1,450	100
LLXND5050PKT100MMG	NRS5014T 100MMGJ	RoHS	10	$\pm 20\%$	23	0.200	1,400	1,600	1,050	1,250	100
LLXND5050PKT150MMG	NRS5014T 150MMGJ	RoHS	15	$\pm 20\%$	20	0.320	1,100	1,300	650	790	100
LLXND5050PKT220MMG	NRS5014T 220MMGJ	RoHS	22	$\pm 20\%$	16	0.450	900	1,000	550	660	100

● 5050WK type

New part number	Old part number (for reference)	EHS	Nominal inductance [μ H]	Inductance tolerance	Self-resonant frequency [MHz] (min.)	DC Resistance [Ω] ($\pm 20\%$)	Rated current ※) [mA]				Measuring frequency [kHz]
							Saturation current: Idc1		Temperature rise current: Idc2		
							Max.	Typ.	Max.	Typ.	
LLXND5050WKTR47NMG	NRS5020T R47NMGJ	RoHS	0.47	$\pm 30\%$	230	0.012	6,100	6,900	5,000	5,800	100
LLXND5050WKT1R0NMG	NRS5020T 1R0NMGJ	RoHS	1.0	$\pm 30\%$	81	0.021	4,000	4,500	3,600	3,710	100
LLXND5050WKT1R5NMG	NRS5020T 1R5NMGJ	RoHS	1.5	$\pm 30\%$	68	0.026	3,350	3,800	3,200	3,540	100
LLXND5050WKT2R2NMG	NRS5020T 2R2NMGJ	RoHS	2.2	$\pm 30\%$	57	0.035	2,900	3,200	2,900	3,200	100
LLXND5050WKT3R3NMG	NRS5020T 3R3NMGJ	RoHS	3.3	$\pm 30\%$	46	0.048	2,400	2,700	2,400	3,080	100
LLXND5050WKT4R7MMG	NRS5020T 4R7MMGJ	RoHS	4.7	$\pm 20\%$	37	0.060	2,000	2,270	2,000	2,370	100
LLXND5050WKT6R8MMG	NRS5020T 6R8MMGJ	RoHS	6.8	$\pm 20\%$	30	0.090	1,600	1,850	1,650	2,200	100
LLXND5050WKT100MMG	NRS5020T 100MMGJ	RoHS	10	$\pm 20\%$	24	0.120	1,300	1,480	1,450	1,850	100
LLXND5050WKT150MMG	NRS5020T 150MMGJ	RoHS	15	$\pm 20\%$	17	0.165	1,100	1,260	1,200	1,480	100
LLXND5050WKT220MMG	NRS5020T 220MMGJ	RoHS	22	$\pm 20\%$	17	0.260	900	1,100	1,000	1,230	100
LLXND5050WKT470MMG	NRS5020T 470MMGJ	RoHS	47	$\pm 20\%$	12	0.435	630	750	560	610	100
LLXND5050WKT101MMG	NRS5020T 101MMGJ	RoHS	100	$\pm 20\%$	7	0.850	420	510	400	450	100

※) The saturation current value (Idc1) is the DC current value having inductance decrease down to 30%. (at 20°C)

※) The temperature rise current value (Idc2) is the DC current value having temperature increase up to 40°C. (at 20°C)

※) The rated current is the DC current value that satisfies both of current value saturation current value and temperature rise current value.

■ PART NUMBER

● 5050WE/5050WD type

New part number	Old part number (for reference)	EHS	Nominal inductance [μ H]	Inductance tolerance	Self-resonant frequency [MHz] (min.)	DC Resistance [Ω] ($\pm 20\%$)	Rated current ※) [mA]				Measuring frequency [kHz]
							Saturation current: Idc1		Temperature rise current: Idc2		
							Max.	Typ.	Max.	Typ.	
LLXND5050WEL1R0NMG	NRS5024T 1R0NMGJ	RoHS	1.0	$\pm 30\%$	85	0.016	5,800	6,800	4,400	4,900	100
LLXND5050WEL1R5NMG	NRS5024T 1R5NMGJ	RoHS	1.5	$\pm 30\%$	67	0.022	5,200	5,800	3,600	4,300	100
LLXND5050WDL2R2NMG	NRS5024T 2R2NMGJ	RoHS	2.2	$\pm 30\%$	51	0.029	4,100	4,800	3,100	3,600	100
LLXND5050WDL3R3NMG	NRS5024T 3R3NMGJ	RoHS	3.3	$\pm 30\%$	41	0.043	3,100	3,700	2,400	2,750	100
LLXND5050WDL4R7MMG	NRS5024T 4R7MMGJ	RoHS	4.7	$\pm 20\%$	37	0.055	2,700	3,400	2,000	2,400	100
LLXND5050WDL6R8MMG	NRS5024T 6R8MMGJ	RoHS	6.8	$\pm 20\%$	28	0.080	2,200	2,750	1,600	1,800	100
LLXND5050WDL100MMG	NRS5024T 100MMGJ	RoHS	10	$\pm 20\%$	21	0.125	1,700	2,100	1,200	1,460	100
LLXND5050WDL150MMG	NRS5024T 150MMGJ	RoHS	15	$\pm 20\%$	18	0.170	1,400	1,750	1,000	1,250	100
LLXND5050WDL220MMG	NRS5024T 220MMGJ	RoHS	22	$\pm 20\%$	15	0.230	1,200	1,450	820	900	100
LLXND5050WDL330MMG	NRS5024T 330MMGJ	RoHS	33	$\pm 20\%$	11	0.370	1,000	1,200	630	700	100

● 5050XA/5050XK type

New part number	Old part number (for reference)	EHS	Nominal inductance [μ H]	Inductance tolerance	Self-resonant frequency [MHz] (min.)	DC Resistance [Ω] ($\pm 30\%$)	Rated current ※) [mA]				Measuring frequency [kHz]
							Saturation current: Idc1		Temperature rise current: Idc2		
							Max.	Typ.	Max.	Typ.	
LLXND5050XATR47NMG	NRS5030T R47NMGJ	RoHS	0.47	$\pm 30\%$	185	0.010	9,000	9,400	5,000	5,900	100
LLXND5050XAT1R0NMG	NRS5030T 1R0NMGJ	RoHS	1.0	$\pm 30\%$	110	0.015	6,600	7,400	4,000	4,900	100
LLXND5050XAT2R2NMG	NRS5030T 2R2NMGJ	RoHS	2.2	$\pm 30\%$	46	0.023	4,200	5,000	3,500	4,100	100
LLXND5050XAT3R3MMG	NRS5030T 3R3MMGJ	RoHS	3.3	$\pm 20\%$	36	0.030	3,600	3,900	3,000	3,600	100
LLXND5050XAT4R7MMG	NRS5030T 4R7MMGJ	RoHS	4.7	$\pm 20\%$	31	0.035	3,100	3,500	2,600	3,000	100
LLXND5050XAT6R8MMG	NRS5030T 6R8MMGJ	RoHS	6.8	$\pm 20\%$	22	0.052	2,500	2,800	2,300	2,500	100
LLXND5050XAT100MMG	NRS5030T 100MMGJ	RoHS	10	$\pm 20\%$	20	0.070	2,100	2,300	1,700	2,000	100
LLXND5050XKT150MMG	NRS5030T 150MMGJ	RoHS	15	$\pm 20\%$	14	0.125	1,600	1,800	1,400	1,550	100
LLXND5050XKT220MMG	NRS5030T 220MMGJ	RoHS	22	$\pm 20\%$	13	0.180	1,400	1,500	1,050	1,200	100
LLXND5050XKT330MMG	NRS5030T 330MMGJ	RoHS	33	$\pm 20\%$	10	0.225	1,150	1,250	800	950	100
LLXND5050XKT470MMG	NRS5030T 470MMGJ	RoHS	47	$\pm 20\%$	9	0.325	950	1,050	700	800	100

● 5050YA/5050YK type

New part number	Old part number (for reference)	EHS	Nominal inductance [μ H]	Inductance tolerance	Self-resonant frequency [MHz] (min.)	DC Resistance [Ω] ($\pm 30\%$)	Rated current ※) [mA]				Measuring frequency [kHz]
							Saturation current: Idc1		Temperature rise current: Idc2		
							Max.	Typ.	Max.	Typ.	
LLXND5050YAL1R5NMG	NRS5040T 1R5NMGJ	RoHS	1.5	$\pm 30\%$	60	0.017	6,400	6,530	4,500	4,730	100
LLXND5050YAL2R2NMG	NRS5040T 2R2NMGJ	RoHS	2.2	$\pm 30\%$	42	0.022	5,000	5,250	3,700	4,080	100
LLXND5050YAL3R3NMG	NRS5040T 3R3NMGJ	RoHS	3.3	$\pm 30\%$	32	0.027	4,000	4,280	3,300	3,770	100
LLXND5050YAL4R7NMG	NRS5040T 4R7NMGJ	RoHS	4.7	$\pm 30\%$	28	0.029	3,300	3,470	3,100	3,500	100
LLXND5050YAL6R8MMG	NRS5040T 6R8MMGJ	RoHS	6.8	$\pm 20\%$	21	0.049	2,800	2,910	2,400	2,470	100
LLXND5050YAL100MMG	NRS5040T 100MMGJ	RoHS	10	$\pm 20\%$	18	0.056	2,300	2,470	2,100	2,210	100
LLXND5050YKL150MMG	NRS5040T 150MMGJ	RoHS	15	$\pm 20\%$	13	0.080	2,000	2,150	1,800	1,920	100
LLXND5050YKL220MMG	NRS5040T 220MMGJ	RoHS	22	$\pm 20\%$	9	0.126	1,500	1,580	1,400	1,470	100
LLXND5050YKL330MMG	NRS5040T 330MMGJ	RoHS	33	$\pm 20\%$	7	0.180	1,300	1,390	1,200	1,270	100
LLXND5050YKL470MMG	NRS5040T 470MMGJ	RoHS	47	$\pm 20\%$	6	0.310	1,100	1,150	900	950	100

● 6060KK type

New part number	Old part number (for reference)	EHS	Nominal inductance [μ H]	Inductance tolerance	Self-resonant frequency [MHz] (min.)	DC Resistance [Ω] ($\pm 20\%$)	Rated current ※) [mA]				Measuring frequency [kHz]
							Saturation current: Idc1		Temperature rise current: Idc2		
							Max.	Typ.	Max.	Typ.	
LLXND6060KKT1R5MMG	NRS6010T 1R5MMGF	RoHS	1.5	$\pm 20\%$	77	0.090	2,400	2,650	1,900	2,150	100
LLXND6060KKT2R2MMG	NRS6010T 2R2MMGF	RoHS	2.2	$\pm 20\%$	56	0.110	1,900	2,120	1,700	1,950	100
LLXND6060KKT3R3MMG	NRS6010T 3R3MMGF	RoHS	3.3	$\pm 20\%$	42	0.135	1,600	1,750	1,500	1,750	100
LLXND6060KKT4R7MMG	NRS6010T 4R7MMGF	RoHS	4.7	$\pm 20\%$	36	0.165	1,300	1,470	1,400	1,600	100
LLXND6060KKT6R8MMG	NRS6010T 6R8MMGF	RoHS	6.8	$\pm 20\%$	30	0.220	1,200	1,300	1,200	1,320	100
LLXND6060KKT100MMG	NRS6010T 100MMGF	RoHS	10	$\pm 20\%$	25	0.270	1,000	1,100	1,100	1,200	100
LLXND6060KKT220MMG	NRS6010T 220MMGF	RoHS	22	$\pm 20\%$	12	0.580	650	720	700	740	100

● 6060MK type

New part number	Old part number (for reference)	EHS	Nominal inductance [μ H]	Inductance tolerance	Self-resonant frequency [MHz] (min.)	DC Resistance [Ω] ($\pm 20\%$)	Rated current ※) [mA]				Measuring frequency [kHz]
							Saturation current: Idc1		Temperature rise current: Idc2		
							Max.	Typ.	Max.	Typ.	
LLXND6060MKT1R0NMG	NRS6012T 1R0NMGJ	RoHS	1.0	$\pm 30\%$	95	0.050	3,000	3,900	2,400	2,700	100
LLXND6060MKT1R5NMG	NRS6012T 1R5NMGG	RoHS	1.5	$\pm 30\%$	69	0.067	2,600	3,500	2,100	2,300	100
LLXND6060MKT2R5NMG	NRS6012T 2R5NMGG	RoHS	2.5	$\pm 30\%$	45	0.090	2,100	2,900	1,800	2,100	100
LLXND6060MKT3R3NMG	NRS6012T 3R3NMGG	RoHS	3.3	$\pm 30\%$	42	0.105	1,800	2,500	1,700	1,950	100
LLXND6060MKT4R7MMG	NRS6012T 4R7MMGG	RoHS	4.7	$\pm 20\%$	36	0.125	1,600	2,100	1,550	1,750	100
LLXND6060MKT5R3MMG	NRS6012T 5R3MMGJ	RoHS	5.3	$\pm 20\%$	34	0.125	1,500	1,750	1,550	1,750	100
LLXND6060MKT6R8MMG	NRS6012T 6R8MMGJ	RoHS	6.8	$\pm 20\%$	30	0.165	1,300	1,600	1,350	1,600	100
LLXND6060MKT100MMG	NRS6012T 100MMGJ	RoHS	10	$\pm 20\%$	22	0.200	1,000	1,400	1,200	1,380	100
LLXND6060MKT150MMG	NRS6012T 150MMGJ	RoHS	15	$\pm 20\%$	18	0.295	800	1,100	800	950	100
LLXND6060MKT220MMG	NRS6012T 220MMGJ	RoHS	22	$\pm 20\%$	12	0.465	760	900	650	750	100
LLXND6060MKT330MMG	NRS6012T 330MMGJ	RoHS	33	$\pm 20\%$	8	0.580	590	800	550	670	100
LLXND6060MKT470MMG	NRS6012T 470MMGJ	RoHS	47	$\pm 20\%$	6	0.965	520	630	460	540	100
LLXND6060MKT680MMG	NRS6012T 680MMGJ	RoHS	68	$\pm 20\%$	3	1.16	440	560	410	450	100
LLXND6060MKT101MMG	NRS6012T 101MMGJ	RoHS	100	$\pm 20\%$	1	1.67	350	490	320	380	100

※) The saturation current value (Idc1) is the DC current value having inductance decrease down to 30%. (at 20°C)

※) The temperature rise current value (Idc2) is the DC current value having temperature increase up to 40°C. (at 20°C)

※) The rated current is the DC current value that satisfies both of current value saturation current value and temperature rise current value.

■ PART NUMBER

● 6060PK type

New part number	Old part number (for reference)	EHS	Nominal inductance [μ H]	Inductance tolerance	Self-resonant frequency [MHz] (min.)	DC Resistance [Ω] ($\pm 20\%$)	Rated current ※) [mA]				Measuring frequency [kHz]
							Saturation current: Idc1		Temperature rise current: Idc2		
							Max.	Typ.	Max.	Typ.	
LLXND6060PKT1R2NMGG	NRS6014T 1R2NMGG	RoHS	1.2	$\pm 30\%$	77	0.042	4,000	4,400	2,750	3,200	100
LLXND6060PKT2R2NMGG	NRS6014T 2R2NMGG	RoHS	2.2	$\pm 30\%$	61	0.055	3,000	3,500	2,300	2,600	100
LLXND6060PKT3R3NMGG	NRS6014T 3R3NMGG	RoHS	3.3	$\pm 30\%$	41	0.075	2,500	2,600	2,000	2,200	100
LLXND6060PKT4R7MMGG	NRS6014T 4R7MMGG	RoHS	4.7	$\pm 20\%$	36	0.090	2,000	2,170	1,900	1,950	100
LLXND6060PKT6R8MMGG	NRS6014T 6R8MMGG	RoHS	6.8	$\pm 20\%$	30	0.115	1,700	1,880	1,650	1,700	100
LLXND6060PKT100MMGG	NRS6014T 100MMGG	RoHS	10	$\pm 20\%$	24	0.140	1,400	1,540	1,400	1,500	100
LLXND6060PKT150MMGG	NRS6014T 150MMGG	RoHS	15	$\pm 20\%$	20	0.210	1,150	1,300	1,200	1,280	100
LLXND6060PKT220MMGG	NRS6014T 220MMGG	RoHS	22	$\pm 20\%$	16	0.300	950	1,100	1,000	1,090	100

● 6060WK type

New part number	Old part number (for reference)	EHS	Nominal inductance [μ H]	Inductance tolerance	Self-resonant frequency [MHz] (min.)	DC Resistance [Ω] ($\pm 20\%$)	Rated current ※) [mA]				Measuring frequency [kHz]
							Saturation current: Idc1		Temperature rise current: Idc2		
							Max.	Typ.	Max.	Typ.	
LLXND6060WKL0R8NMGG	NRS6020T 0R8NMGG	RoHS	0.8	$\pm 30\%$	110	0.020	6,400	7,400	4,100	4,800	100
LLXND6060WKL1R5NMGG	NRS6020T 1R5NMGG	RoHS	1.5	$\pm 30\%$	93	0.026	4,300	5,300	3,600	4,200	100
LLXND6060WKL2R2NMGG	NRS6020T 2R2NMGG	RoHS	2.2	$\pm 30\%$	73	0.034	3,200	4,000	2,900	3,400	100
LLXND6060WKL3R3NMGG	NRS6020T 3R3NMGG	RoHS	3.3	$\pm 30\%$	55	0.040	2,800	3,400	2,750	3,100	100
LLXND6060WKL4R7NMGG	NRS6020T 4R7NMGG	RoHS	4.7	$\pm 30\%$	43	0.058	2,400	2,800	2,150	2,500	100
LLXND6060WKL6R8NMGG	NRS6020T 6R8NMGG	RoHS	6.8	$\pm 30\%$	30	0.085	2,000	2,600	1,800	2,100	100
LLXND6060WKL100MMGG	NRS6020T 100MMGG	RoHS	10	$\pm 20\%$	18	0.125	1,900	2,240	1,500	1,700	100
LLXND6060WKL220MMGG	NRS6020T 220MMGG	RoHS	22	$\pm 20\%$	11	0.290	1,250	1,470	950	1,100	100

● 6060WH type

New part number	Old part number (for reference)	EHS	Nominal inductance [μ H]	Inductance tolerance	Self-resonant frequency [MHz] (min.)	DC Resistance [Ω] ($\pm 30\%$)	Rated current ※) [mA]				Measuring frequency [kHz]
							Saturation current: Idc1		Temperature rise current: Idc2		
							Max.	Typ.	Max.	Typ.	
LLXND6060WHL0R9NMGG	NRS6028T 0R9NMGG	RoHS	0.9	$\pm 30\%$	90	0.013	6,700	7,900	4,600	5,200	100
LLXND6060WHL1R5NMGG	NRS6028T 1R5NMGG	RoHS	1.5	$\pm 30\%$	78	0.016	5,100	6,100	4,200	4,700	100
LLXND6060WHL2R2NMGG	NRS6028T 2R2NMGG	RoHS	2.2	$\pm 30\%$	68	0.020	4,200	5,100	3,700	4,200	100
LLXND6060WHL3R3NMGG	NRS6028T 3R3NMGG	RoHS	3.0	$\pm 30\%$	55	0.023	3,600	4,300	3,400	3,900	100
LLXND6060WHL4R7MMGG	NRS6028T 4R7MMGG	RoHS	4.7	$\pm 20\%$	39	0.031	2,700	3,300	3,000	3,400	100
LLXND6060WHL6R8MMGG	NRS6028T 6R8MMGG	RoHS	6.8	$\pm 20\%$	25	0.043	2,600	3,000	2,500	2,900	100
LLXND6060WHL100MMGG	NRS6028T 100MMGG	RoHS	10	$\pm 20\%$	20	0.065	1,900	2,200	1,900	2,200	100
LLXND6060WHL150MMGG	NRS6028T 150MMGG	RoHS	15	$\pm 20\%$	17	0.095	1,600	1,900	1,800	1,900	100
LLXND6060WHL220MMGG	NRS6028T 220MMGG	RoHS	22	$\pm 20\%$	12	0.135	1,300	1,600	1,400	1,600	100
LLXND6060WHL330MMGG	NRS6028T 330MMGG	RoHS	33	$\pm 20\%$	10	0.220	1,100	1,300	1,100	1,250	100
LLXND6060WHL470MMGG	NRS6028T 470MMGG	RoHS	47	$\pm 20\%$	8	0.300	1,000	1,150	920	1,050	100
LLXND6060WHL680MMGG	NRS6028T 680MMGG	RoHS	68	$\pm 20\%$	5	0.420	800	950	770	880	100
LLXND6060WHL101MMGG	NRS6028T 101MMGG	RoHS	100	$\pm 20\%$	3	0.600	650	750	660	750	100

● 6060YE type

New part number	Old part number (for reference)	EHS	Nominal inductance [μ H]	Inductance tolerance	Self-resonant frequency [MHz] (min.)	DC Resistance [Ω] ($\pm 30\%$)	Rated current ※) [mA]				Measuring frequency [kHz]
							Saturation current: Idc1		Temperature rise current: Idc2		
							Max.	Typ.	Max.	Typ.	
LLXND6060YEL1R0NMGG	NRS6045T 1R0NMGG	RoHS	1.0	$\pm 30\%$	110	0.014	9,800	11,000	4,500	5,200	100
LLXND6060YEL1R3NMGG	NRS6045T 1R3NMGG	RoHS	1.3	$\pm 30\%$	95	0.016	8,200	9,300	4,200	4,800	100
LLXND6060YEL1R5NMGG	NRS6045T 1R5NMGG	RoHS	1.5	$\pm 30\%$	95	0.016	8,200	9,300	4,200	4,800	100
LLXND6060YEL1R8NMGG	NRS6045T 1R8NMGG	RoHS	1.8	$\pm 30\%$	80	0.019	7,200	8,100	3,900	4,400	100
LLXND6060YEL2R2NMGG	NRS6045T 2R2NMGG	RoHS	2.2	$\pm 30\%$	60	0.022	6,400	7,300	3,600	4,100	100
LLXND6060YEL2R3NMGG	NRS6045T 2R3NMGG	RoHS	2.3	$\pm 30\%$	60	0.022	6,400	7,300	3,600	4,100	100
LLXND6060YEL3R0NMGG	NRS6045T 3R0NMGG	RoHS	3.0	$\pm 30\%$	45	0.024	5,600	6,500	3,300	4,000	100
LLXND6060YEL3R3NMGG	NRS6045T 3R3NMGG	RoHS	3.3	$\pm 30\%$	45	0.024	5,600	6,500	3,300	4,000	100
LLXND6060YEL4R5MMGG	NRS6045T 4R5MMGG	RoHS	4.5	$\pm 20\%$	25	0.030	4,400	5,400	3,100	3,600	100
LLXND6060YEL4R7NMGG	NRS6045T 4R7NMGG	RoHS	4.7	$\pm 30\%$	25	0.030	4,400	5,400	3,100	3,600	100
LLXND6060YEL6R3MMGG	NRS6045T 6R3MMGG	RoHS	6.3	$\pm 20\%$	15	0.036	3,600	4,300	3,000	3,300	100
LLXND6060YEL6R8MMGG	NRS6045T 6R8MMGG	RoHS	6.8	$\pm 20\%$	15	0.036	3,600	4,300	3,000	3,300	100
LLXND6060YEL100MMGG	NRS6045T 100MMGG	RoHS	10	$\pm 20\%$	12	0.046	3,100	3,600	2,400	2,800	100
LLXND6060YEL150MMGG	NRS6045T 150MMGG	RoHS	15	$\pm 20\%$	10	0.070	2,500	3,000	1,900	2,300	100
LLXND6060YEL220MMGG	NRS6045T 220MMGG	RoHS	22	$\pm 20\%$	7	0.107	2,000	2,400	1,600	1,900	100
LLXND6060YEL330MMGG	NRS6045T 330MMGG	RoHS	33	$\pm 20\%$	6	0.141	1,650	2,000	1,400	1,600	100
LLXND6060YEL470MMGG	NRS6045T 470MMGG	RoHS	47	$\pm 20\%$	5	0.211	1,400	1,600	1,150	1,350	100
LLXND6060YEL680MMGG	NRS6045T 680MMGG	RoHS	68	$\pm 20\%$	4	0.304	1,100	1,300	950	1,100	100
LLXND6060YEL101MMGG	NRS6045T 101MMGG	RoHS	100	$\pm 20\%$	3	0.466	900	1,200	750	900	100

※) The saturation current value (Idc1) is the DC current value having inductance decrease down to 30%. (at 20°C)

※) The temperature rise current value (Idc2) is the DC current value having temperature increase up to 40°C. (at 20°C)

※) The rated current is the DC current value that satisfies both of current value saturation current value and temperature rise current value.

PART NUMBER

● 8080XK type

New part number	Old part number (for reference)	EHS	Nominal inductance [μ H]	Inductance tolerance	Self-resonant frequency [MHz] (min.)	DC Resistance [Ω] ($\pm 30\%$)	Rated current ※) [mA]				Measuring frequency [kHz]
							Saturation current: Idc1		Temperature rise current: Idc2		
							Max.	Typ.	Max.	Typ.	
LLXNH8080XKL1R0NJG	NRS8030T 1R0NJGJ	RoHS	1.0	$\pm 30\%$	120	0.009	7,800	9,300	6,200	7,600	100
LLXNH8080XKL1R5NJG	NRS8030T 1R5NJGJ	RoHS	1.5	$\pm 30\%$	80	0.012	6,200	7,800	5,300	6,400	100
LLXNH8080XKL2R2NJG	NRS8030T 2R2NJGJ	RoHS	2.2	$\pm 30\%$	60	0.015	4,900	6,100	4,800	5,600	100
LLXNH8080XKL3R3MJG	NRS8030T 3R3MJGJ	RoHS	3.3	$\pm 20\%$	50	0.019	4,200	5,200	4,300	5,100	100
LLXNH8080XKL4R7MJG	NRS8030T 4R7MJGJ	RoHS	4.7	$\pm 20\%$	40	0.022	3,600	4,400	4,000	4,700	100
LLXNH8080XKL6R8MJG	NRS8030T 6R8MJGJ	RoHS	6.8	$\pm 20\%$	32	0.029	3,000	3,600	3,400	4,000	100
LLXNH8080XKL100MJG	NRS8030T 100MJGJ	RoHS	10	$\pm 20\%$	27	0.033	2,400	2,900	3,000	3,600	100
LLXNH8080XKL150MJG	NRS8030T 150MJGJ	RoHS	15	$\pm 20\%$	20	0.060	2,000	2,300	2,200	2,600	100
LLXNH8080XKL220MJG	NRS8030T 220MJGJ	RoHS	22	$\pm 20\%$	16	0.070	1,750	2,200	1,900	2,300	100
LLXNH8080XKL330MJG	NRS8030T 330MJGJ	RoHS	33	$\pm 20\%$	13	0.120	1,300	1,600	1,500	1,800	100
LLXNH8080XKL470MJG	NRS8030T 470MJGJ	RoHS	47	$\pm 20\%$	11	0.170	1,100	1,400	1,300	1,500	100

● 8080YB/8080YK type

New part number	Old part number (for reference)	EHS	Nominal inductance [μ H]	Inductance tolerance	Self-resonant frequency [MHz] (min.)	DC Resistance [Ω] ($\pm 30\%$)	Rated current ※) [mA]				Measuring frequency [kHz]
							Saturation current: Idc1		Temperature rise current: Idc2		
							Max.	Typ.	Max.	Typ.	
LLXNH8080YBL0R9NJG	NRS8040T 0R9NJGJ	RoHS	0.9	$\pm 30\%$	85	0.006	13,000	14,000	7,800	9,600	100
LLXNH8080YBL1R0NJG	NRS8040T 1R0NJGJ	RoHS	1	$\pm 30\%$	85	0.006	13,000	14,000	7,800	9,600	100
LLXNH8080YBL1R4NJG	NRS8040T 1R4NJGJ	RoHS	1.4	$\pm 30\%$	63	0.007	10,000	11,000	7,000	8,400	100
LLXNH8080YBL1R5NJG	NRS8040T 1R5NJGJ	RoHS	1.5	$\pm 30\%$	63	0.007	10,000	11,000	7,000	8,400	100
LLXNH8080YBL2R0NJG	NRS8040T 2R0NJGJ	RoHS	2.0	$\pm 30\%$	50	0.009	8,100	9,200	6,300	7,600	100
LLXNH8080YBL2R2NJG	NRS8040T 2R2NJGJ	RoHS	2.2	$\pm 30\%$	50	0.009	8,100	9,200	6,300	7,600	100
LLXNH8080YBL3R3NJG	NRS8040T 3R3NJGJ	RoHS	3.3	$\pm 30\%$	34	0.015	6,400	6,800	4,900	6,000	100
LLXNH8080YBL3R6NJG	NRS8040T 3R6NJGJ	RoHS	3.6	$\pm 30\%$	34	0.015	6,400	6,800	4,900	6,000	100
LLXNH8080YBL4R7NJG	NRS8040T 4R7NJGJ	RoHS	4.7	$\pm 30\%$	30	0.018	5,400	5,900	4,100	5,200	100
LLXNH8080YBL6R8NJG	NRS8040T 6R8NJGJ	RoHS	6.8	$\pm 30\%$	24	0.025	4,400	4,800	3,700	4,400	100
LLXNH8080YKL100MJG	NRS8040T 100MJGJ	RoHS	10	$\pm 20\%$	22	0.034	3,800	4,100	3,100	3,500	100
LLXNH8080YKL150MJG	NRS8040T 150MJGJ	RoHS	15	$\pm 20\%$	16	0.050	2,900	3,200	2,400	3,000	100
LLXNH8080YKL220MJG	NRS8040T 220MJGJ	RoHS	22	$\pm 20\%$	13	0.066	2,400	2,700	2,200	2,600	100
LLXNH8080YKL330MJG	NRS8040T 330MJGJ	RoHS	33	$\pm 20\%$	12	0.100	2,000	2,300	1,700	1,900	100
LLXNH8080YKL470MJG	NRS8040T 470MJGJ	RoHS	47	$\pm 20\%$	8	0.140	1,500	1,800	1,500	1,600	100
LLXNH8080YKL680MJG	NRS8040T 680MJGJ	RoHS	68	$\pm 20\%$	7	0.210	1,300	1,500	1,200	1,300	100
LLXNH8080YKL101MJG	NRS8040T 101MJGJ	RoHS	100	$\pm 20\%$	6	0.280	1,100	1,300	1,000	1,100	100
LLXNH8080YKL151MJG	NRS8040T 151MJGJ	RoHS	150	$\pm 20\%$	5	0.420	900	980	800	890	100
LLXNH8080YKL221MJG	NRS8040T 221MJGJ	RoHS	220	$\pm 20\%$	4	0.620	700	800	670	740	100

※) The saturation current value (Idc1) is the DC current value having inductance decrease down to 30%. (at 20°C)

※) The temperature rise current value (Idc2) is the DC current value having temperature increase up to 40°C. (at 20°C)

※) The rated current is the DC current value that satisfies both of current value saturation current value and temperature rise current value.

Wire-wound Ferrite Power Inductors LSXN/LSXP/LCXN/LCXP/LBXN/LBXP/
 LLXN/LLXP/LMXN/LMXP series
 Wire-wound Ferrite Power Inductors LAXH/LCXH/LBXH/LMXH series
 Wire-wound Ferrite Inductors for Class D Amplifier LCXA

■ PACKAGING

① Minimum Quantity

Type	Standard Quantity [pcs]
	Tape & Reel
2020KK	2500
2020MK	2500
2424KK	2500
2424MK	2500
3030KK	2000
3030MK	2000
3030QK	2000
4040KK	5000
4040MK	4500
4040TK	3500
4040WK	700

Type	Standard Quantity [pcs]
	Tape & Reel
5050KK	1000
5050MK	1000
5050PK	1000
5050WB	800
5050WK	800
5050WD	2500
5050WE	2500
5050XK	500
5050XA	500
5050YA	1500
5050YK	1500
6060KK	1000
6060MK	1000
6060PK	1000
6060WK	2500
6060WH	2000
6060XK	2000
6060YE	1500
8080XK	1000
8080YK	1000
8080YB	1000

② Tape Material

● Embossed Tape

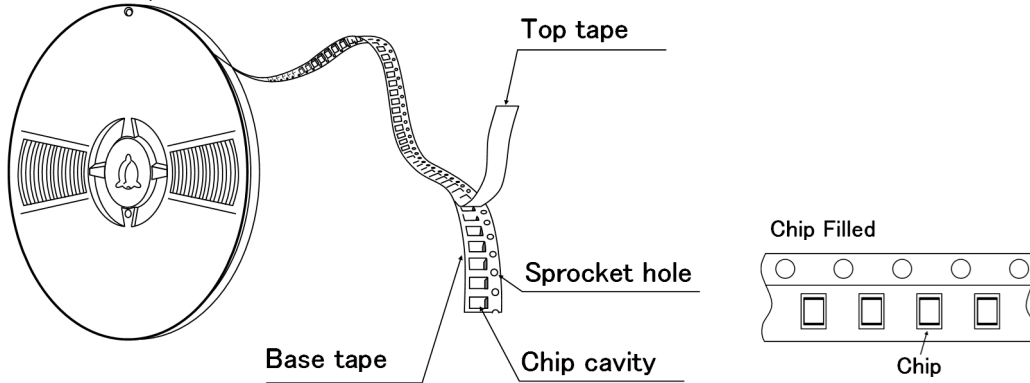

③ Taping dimensions

● Embossed tape 8mm wide (0.315 inches wide)

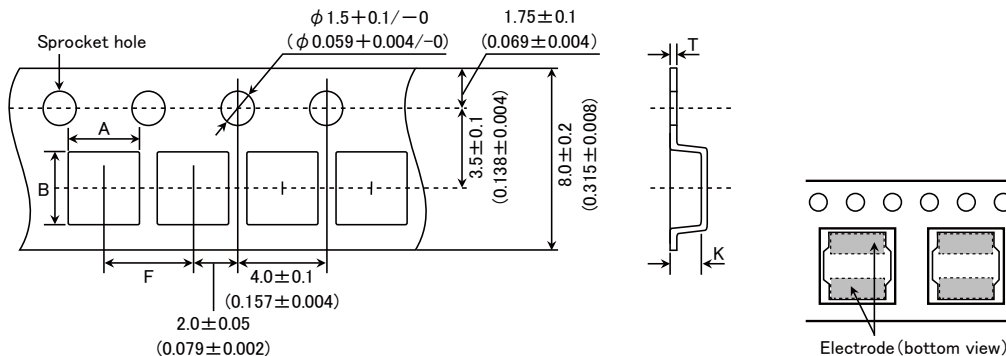

▶ This catalog contains the typical specification only due to the limitation of space. When you consider the purchase of our products, please check our specification. For details of each product (characteristics graph, reliability information, precautions for use, and so on), see our Web site (<http://www.ty-top.com/>).

Type	Chip cavity		Insertion pitch	Tape thickness	
	A	B		T	K
2020KK 2020MK	2.2±0.1 (0.102±0.004)	2.2±0.1 (0.102±0.004)	4.0±0.1 (0.157±0.004)	0.25±0.05 (0.009±0.002)	1.3±0.1 (0.051±0.004)
2424KK 2424MK	2.6±0.1 (0.087±0.004)	2.6±0.1 (0.102±0.004)		0.25±0.05 (0.009±0.002)	1.3±0.1 (0.051±0.004)
3030KK	3.2±0.1 (0.126±0.004)	3.2±0.1 (0.126±0.004)		0.3±0.05 (0.012±0.002)	1.4±0.1 (0.055±0.004)
3030MK					1.6±0.1 (0.063±0.004)
3030QK					1.9±0.1 (0.075±0.004)

Unit: mm (inch)

● Embossed tape 12mm wide (0.47 inches wide)

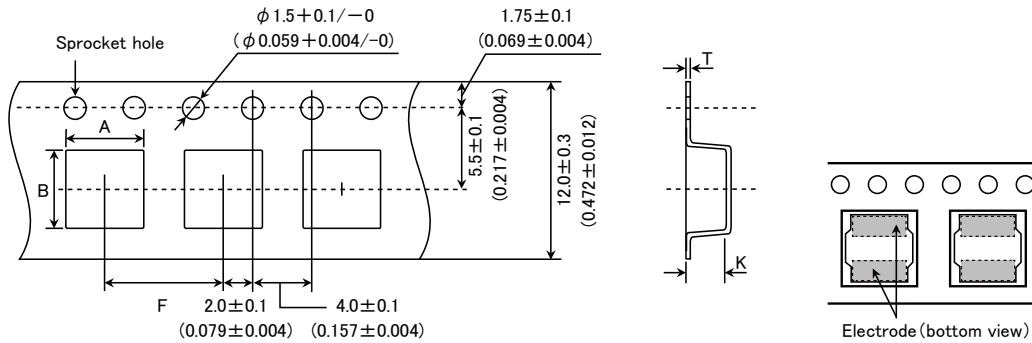

Type	Chip cavity		Insertion pitch	Tape thickness	
	A	B		T	K
4040KK	4.3±0.1 (0.169±0.004)	4.3±0.1 (0.169±0.004)	8.0±0.1 (0.315±0.004)	0.3±0.1 (0.012±0.004)	1.4±0.1 (0.055±0.004)
4040MK					1.6±0.1 (0.063±0.004)
4040TK 4040WK					2.1±0.1 (0.083±0.004)
5050KK	1.4±0.1 (0.055±0.004)				
5050MK	1.4±0.1 (0.055±0.004)				
5050PK	1.6±0.1 (0.063±0.004)				
5050WB 5050WK	2.3±0.1 (0.091±0.004)				
5050WD 5050WE	2.7±0.1 (0.106±0.004)				
5050XK 5050XA	5.15±0.1 (0.203±0.004)	5.15±0.1 (0.203±0.004)		0.4±0.1 (0.016±0.004)	3.2±0.1 (0.126±0.004)
5050YK 5050YA	5.15±0.1 (0.203±0.004)	5.15±0.1 (0.203±0.004)			4.2±0.1 (0.165±0.004)
6060KK	6.3±0.1 (0.248±0.004)	6.3±0.1 (0.248±0.004)	1.4±0.1 (0.055±0.004)		1.4±0.1 (0.055±0.004)
6060MK					1.6±0.1 (0.063±0.004)
6060PK					1.6±0.1 (0.063±0.004)
6060WK					2.3±0.1 (0.090±0.004)
6060WH 6060XK					3.1±0.1 (0.122±0.004)
6060YE					4.7±0.1 (0.185±0.004)

Unit: mm (inch)

► This catalog contains the typical specification only due to the limitation of space. When you consider the purchase of our products, please check our specification. For details of each product (characteristics graph, reliability information, precautions for use, and so on), see our Web site (<http://www.ty-top.com/>).

● Embossed tape 16mm wide (0.63 inches wide)

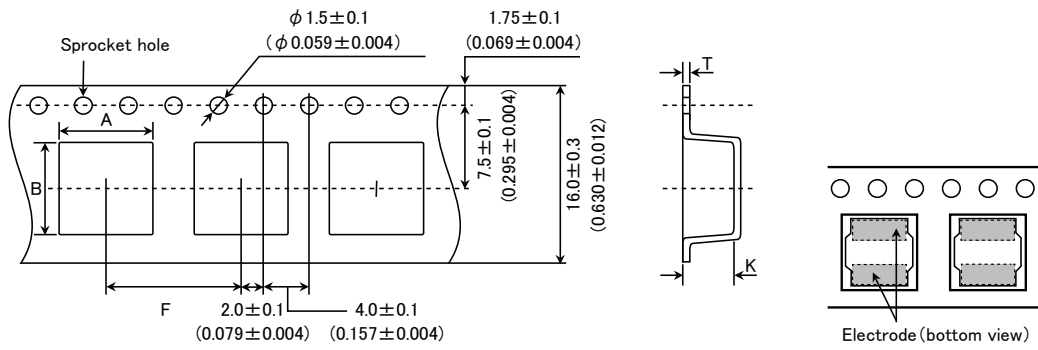

Type	Chip cavity		Insertion pitch F	Tape thickness	
	A	B		T	K
8080XK	8.3 ± 0.1 (0.327 ± 0.004)	8.3 ± 0.1 (0.327 ± 0.004)	12.0 ± 0.1 (0.472 ± 0.004)	0.5 ± 0.1 (0.020 ± 0.004)	3.4 ± 0.1 (0.134 ± 0.004)
8080YK					4.5 ± 0.1 (0.177 ± 0.004)
8080YB					4.5 ± 0.1 (0.177 ± 0.004)

Unit: mm (inch)

④ Leader and Blank portion

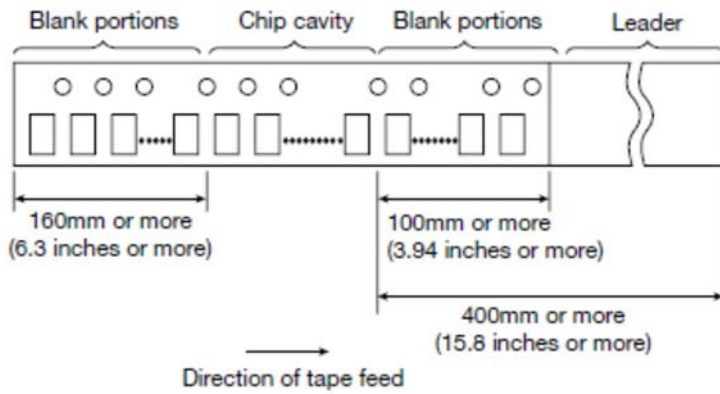

⑤ Reel size

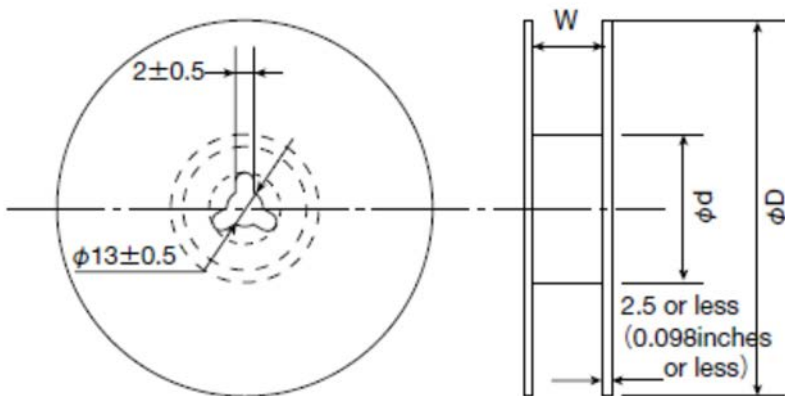

► This catalog contains the typical specification only due to the limitation of space. When you consider the purchase of our products, please check our specification. For details of each product (characteristics graph, reliability information, precautions for use, and so on), see our Web site (<http://www.ty-top.com/>).

Type	Reel size (Reference values)		
	ϕD	ϕd	W
2020KK	180±0.5 (7.087±0.019)	60±1.0 (2.36±0.04)	10.0±1.5 (0.394±0.059)
2020MK			
2424KK			
2424MK			
3030KK			
3030MK			
3030QK			
4040WK	180±3.0 (7.087±0.118)	60±2.0 (2.36±0.08)	14.0±1.5 (0.551±0.059)
5050KK			
5050MK			
5050PK			
5050WB			
5050WK			
5050XK			
5050XA			
6060KK			
6060MK			
6060PK			

Unit: mm (inch)

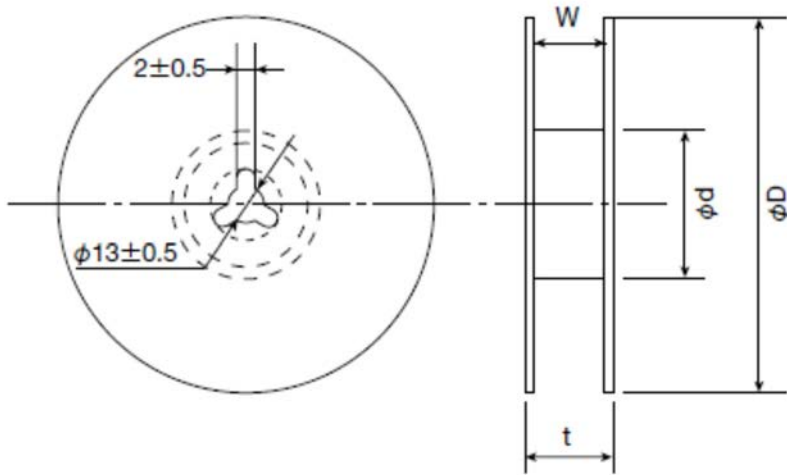

Type	Reel size (Reference values)			
	ϕD	ϕd	t (max.)	W
4040KK	330±3.0 (12.99±0.118)	80±2.0 (3.15±0.078)	18.5 (0.72)	13.5±1.0 (0.531±0.04)
4040MK				
4040TK				
5050WD				
5050WE				
5050YA				
5050YK				
6060WK				
6060WH				
6060XK				
6060YE				
8080XK			22.5 (0.89)	17.5±1.0 (0.689±0.04)
8080YK				
8080YB				

Unit: mm (inch)

⑥ Top Tape Strength

The top tape requires a peel-off force of 0.1 to 1.3N in the direction of the arrow as illustrated below.

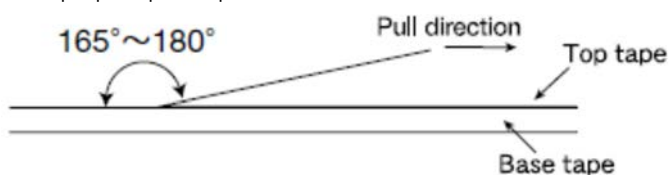

**Wire-wound Ferrite Power Inductors LSXN/LSXP series
for General Electronic Equipment for Consumer**
**Wire-wound Ferrite Power Inductors LLXN/LLXP series
for Medical Devices classified as GHTF Classes A or B (Japan Classes I or II)**

■ RELIABILITY DATA

1. Operating Temperature Range													
Specified Value	-25~+120°C (LSXN: 2020~3030 type, LSXP: 2020~3030 type) -25~+125°C (LSXN: 4040~8080 type) -25~+120°C (LLXN: 2020~3030 type, LLXP: 2020~3030 type) -25~+125°C (LLXN: 4040~8080 type)												
Test Methods and Remarks	Including self-generated heat												
2. Storage Temperature Range													
Specified Value	-40~+85°C												
Test Methods and Remarks	-5 to 40°C for the product with taping.												
3. Rated current													
Specified Value	Within the specified tolerance												
4. Inductance													
Specified Value	Within the specified tolerance												
Test Methods and Remarks	Measuring equipment : LCR Meter (HP 4285A or equivalent) Measuring frequency : 100kHz, 1V												
5. DC Resistance													
Specified Value	Within the specified tolerance												
Test Methods and Remarks	Measuring equipment : DC ohmmeter (HIOKI 3227 or equivalent)												
6. Self resonance frequency													
Specified Value	Within the specified tolerance												
Test Methods and Remarks	Measuring equipment : Impedance analyzer/material analyzer (HP4291A or equivalent HP4191A, 4192A or equivalent)												
7. Temperature characteristic													
Specified Value	Inductance change : Within $\pm 20\%$												
Test Methods and Remarks	Measurement of inductance shall be taken at temperature range within $-25^{\circ}\text{C} \sim +85^{\circ}\text{C}$. With reference to inductance value at $+20^{\circ}\text{C}$., change rate shall be calculated. Change of maximum inductance deviation in step 1 to 5 <table border="1" style="margin-left: 20px;"> <thead> <tr> <th>Step</th> <th>Temperature (°C)</th> </tr> </thead> <tbody> <tr> <td>1</td> <td>20</td> </tr> <tr> <td>2</td> <td>Minimum operating temperature</td> </tr> <tr> <td>3</td> <td>20 (Standard temperature)</td> </tr> <tr> <td>4</td> <td>Maximum operating temperature</td> </tr> <tr> <td>5</td> <td>20</td> </tr> </tbody> </table>	Step	Temperature (°C)	1	20	2	Minimum operating temperature	3	20 (Standard temperature)	4	Maximum operating temperature	5	20
Step	Temperature (°C)												
1	20												
2	Minimum operating temperature												
3	20 (Standard temperature)												
4	Maximum operating temperature												
5	20												

▶ This catalog contains the typical specification only due to the limitation of space. When you consider the purchase of our products, please check our specification.
For details of each product (characteristics graph, reliability information, precautions for use, and so on), see our Web site (<http://www.ty-top.com/>).

8. Resistance to flexure of substrate

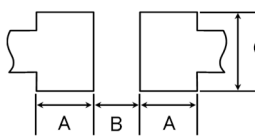
Specified Value	No damage																																			
Test Methods and Remarks	The test samples shall be soldered to the test board by the reflow. As illustrated below, apply force in the direction of the arrow indicating until deflection of the test board reaches to 2 mm.																																			
	Test board size	: 100 × 40 × 1.0																																		
	Test board material	: Glass epoxy-resin																																		
	Solder cream thickness	: 0.10mm (2020~3030 type)																																		
		: 0.15mm (4040~8080 type)																																		
	Land dimension																																			
																																				
		<table border="1"> <thead> <tr> <th>Type</th> <th>A</th> <th>B</th> <th>C</th> </tr> </thead> <tbody> <tr> <td>2020</td> <td>0.65</td> <td>0.7</td> <td>2.0</td> </tr> <tr> <td>2424</td> <td>0.7</td> <td>0.75</td> <td>2.0</td> </tr> <tr> <td>3030</td> <td>0.8</td> <td>1.4</td> <td>2.7</td> </tr> <tr> <td>4040</td> <td>1.2</td> <td>1.6</td> <td>3.7</td> </tr> <tr> <td>5050</td> <td>1.5</td> <td>2.1</td> <td>4.0</td> </tr> <tr> <td>6060</td> <td>1.6</td> <td>3.1</td> <td>5.7</td> </tr> <tr> <td>8080</td> <td>1.8</td> <td>3.8</td> <td>7.5</td> </tr> </tbody> </table>	Type	A	B	C	2020	0.65	0.7	2.0	2424	0.7	0.75	2.0	3030	0.8	1.4	2.7	4040	1.2	1.6	3.7	5050	1.5	2.1	4.0	6060	1.6	3.1	5.7	8080	1.8	3.8	7.5		
Type	A	B	C																																	
2020	0.65	0.7	2.0																																	
2424	0.7	0.75	2.0																																	
3030	0.8	1.4	2.7																																	
4040	1.2	1.6	3.7																																	
5050	1.5	2.1	4.0																																	
6060	1.6	3.1	5.7																																	
8080	1.8	3.8	7.5																																	

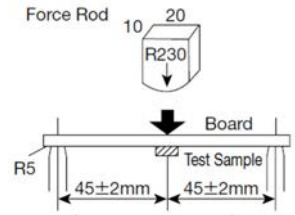

9. Insulation resistance : between wires

Specified Value	—
-----------------	---

10. Insulation resistance : between wire and core

Specified Value	—
-----------------	---

11. Withstanding voltage : between wire and core

Specified Value	—
-----------------	---

12. Adhesion of terminal electrode

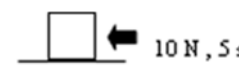
Specified Value	Shall not come off PC board			
Test Methods and Remarks	The test samples shall be soldered to the test board by the reflow.			
	Applied force	: 10N to X and Y directions.		
	Duration	: 5s.		
	Solder cream thickness	: 0.10mm (2020~3030 type)		
		: 0.15mm (4040~8080 type)		
				

13. Resistance to vibration

Specified Value	Inductance change : Within ±10%			
	No significant abnormality in appearance.			
Test Methods and Remarks	The test samples shall be soldered to the test board by the reflow.			
	Then it shall be submitted to below test conditions.			
	Frequency Range	10~55Hz		
	Total Amplitude	1.5mm (May not exceed acceleration 196m/s ²)		
	Sweeping Method	10Hz to 55Hz to 10Hz for 1min.		
	Time	X	Y	Z
		For 2 hours on each X, Y, and Z axis.		
	Recovery	: At least 2hrs of recovery under the standard condition after the test, followed by the measurement within 48hrs.		

► This catalog contains the typical specification only due to the limitation of space. When you consider the purchase of our products, please check our specification. For details of each product (characteristics graph, reliability information, precautions for use, and so on), see our Web site (<http://www.ty-top.com/>).

14. Solderability

Specified Value	At least 90% of surface of terminal electrode is covered by new solder.	
Test Methods and Remarks	The test samples shall be dipped in flux, and then immersed in molten solder as shown in below table. Flux : Ethanol solution containing rosin 25%.	
	Solder Temperature	245±5°C
	Time	5±1.0 sec.
※Immersion depth : All sides of mounting terminal shall be immersed.		

15. Resistance to soldering heat

Specified Value	Inductance change : Within ±10% No significant abnormality in appearance.	
Test Methods and Remarks	The test sample shall be exposed to reflow oven at 230±5°C for 40 seconds, with peak temperature at 260±5°C for 5 seconds, 2 times. Test board material : Glass epoxy-resin Test board thickness : 1.0mm	

16. Thermal shock

Specified Value	Inductance change : Within ±10% No significant abnormality in appearance.		
Test Methods and Remarks	The test samples shall be soldered to the test board by the reflow. The test samples shall be placed at specified temperature for specified time by step 1 to step 4 as shown in below table in sequence. The temperature cycle shall be repeated 100 cycles.		
	Conditions of 1 cycle		
	Step	Temperature (°C)	Duration (min)
	1	-40±3	30±3
	2	Room temperature	Within 3
3	+85±2	30±3	
4	Room temperature	Within 3	
Recovery : At least 2hrs of recovery under the standard condition after the test, followed by the measurement within 48hrs.			

17. Damp heat

Specified Value	Inductance change : Within ±10% No significant abnormality in appearance.	
Test Methods and Remarks	The test samples shall be soldered to the test board by the reflow. The test samples shall be placed in thermostatic oven set at specified temperature and humidity as shown in below table.	
	Temperature	60±2°C
	Humidity	90~95%RH
	Time	500+24/-0 hour
Recovery : At least 2hrs of recovery under the standard condition after the test, followed by the measurement within 48hrs.		

18. Loading under damp heat

Specified Value	Inductance change : Within ±10% No significant abnormality in appearance.	
Test Methods and Remarks	The test samples shall be soldered to the test board by the reflow. The test samples shall be placed in thermostatic oven set at specified temperature and humidity and applied the rated current continuously as shown in below table.	
	Temperature	60±2°C
	Humidity	90~95%RH
	Applied current	Rated current
	Time	500+24/-0 hour
Recovery : At least 2hrs of recovery under the standard condition after the test, followed by the measurement within 48hrs.		

19. Low temperature life test

Specified Value	Inductance change : Within ±10% No significant abnormality in appearance.	
Test Methods and Remarks	The test samples shall be soldered to the test board by the reflow. After that, the test samples shall be placed at test conditions as shown in below table.	
	Temperature	-40±2°C
	Time	500+24/-0 hour
Recovery : At least 2hrs of recovery under the standard condition after the test, followed by the measurement within 48hrs.		

▶ This catalog contains the typical specification only due to the limitation of space. When you consider the purchase of our products, please check our specification.
For details of each product (characteristics graph, reliability information, precautions for use, and so on), see our Web site (<http://www.ty-top.com/>).

20. High temperature life test

Specified Value	—
-----------------	---

21. Loading at high temperature life test

Specified Value	Inductance change : Within $\pm 10\%$ No significant abnormality in appearance.	
Test Methods and Remarks	The test samples shall be soldered to the test board by the reflow soldering.	
	Temperature	$85 \pm 2^\circ\text{C}$
	Applied current	Rated current
	Time	$500 + 24 / - 0$ hour
	Recovery : At least 2hrs of recovery under the standard condition after the test, followed by the measurement within 48hrs.	

22. Standard condition

Specified Value	Standard test condition : Unless otherwise specified, temperature is $20 \pm 15^\circ\text{C}$ and $65 \pm 20\%$ of relative humidity. When there is any question concerning measurement result: In order to provide correlation data, the test shall be condition of $20 \pm 2^\circ\text{C}$ of temperature, $65 \pm 5\%$ relative humidity. Inductance is in accordance with our measured value.
-----------------	--

Wire-wound Ferrite Power Inductors LSXN/LSXP series

for General Electronic Equipment for Consumer

Wire-wound Ferrite Power Inductors LSXBH10050 for General Electronic Equipment for Consumer

Wire-wound Ferrite Power Inductors LSRN series for General Electronic Equipment for Consumer

Wire-wound Ferrite Power Inductors LLXN/LLXP series

for Medical Devices classified as GHTF Classes A or B (Japan Classes I or II)

Wire-wound Ferrite Power Inductors LLXBH10050

for Medical Devices classified as GHTF Classes A or B (Japan Classes I or II)

Wire-wound Ferrite Power Inductors LLRN series

for Medical Devices classified as GHTF Classes A or B (Japan Classes I or II)

PRECAUTIONS

1. Circuit Design

Precautions	<ul style="list-style-type: none"> ◆ Verification of operating environment, electrical rating and performance <ol style="list-style-type: none"> 1. A malfunction in medical equipment, spacecraft, nuclear reactors, etc. may cause serious harm to human life or have severe social ramifications. As such, any inductors to be used in such equipment may require higher safety and/or reliability considerations and should be clearly differentiated from components used in general purpose applications. 2. When inductors are used in places where dew condensation develops and/or where corrosive gas such as hydrogen sulfide, sulfurous acid, or chlorine exists in the air, characteristic deterioration may occur. Please do not use inductors under such environmental conditions. ◆ Operating Current (Verification of Rated current) <ol style="list-style-type: none"> 1. The operating current including inrush current for inductors must always be lower than their rated values. 2. Do not apply current in excess of the rated value because the inductance may be reduced due to the magnetic saturation effect. ◆ Temperature rise <p>Temperature rise of power choke coil depends on the installation condition in end products.</p> <p>Make sure that temperature rise of power choke coils in actual end products is within the specified temperature range.</p>
-------------	--

2. PCB Design

Precautions	<ul style="list-style-type: none"> ◆ Land pattern design <ol style="list-style-type: none"> 1. Please refer to a recommended land pattern. 2. There is stress, which has been caused by distortion of a PCB, to the inductor. (LSXN/LSXP/LLXN/LLXP) 3. Please consider the arrangement of parts on a PCB. (LSXN/LSXP/LLXN/LLXP)
Technical considerations	<ul style="list-style-type: none"> ◆ Land pattern design <p>Surface Mounting</p> <ol style="list-style-type: none"> 1. Mounting and soldering conditions should be checked beforehand. 2. Applicable soldering process to this products is reflow soldering only. 3. Please use the recommended land pattern shown as below. Electrical characteristics and the mounting ability of the product are being considered in the recommended land pattern. If a PCB is designed with other dimensions, defective soldering and stress to a product may occur due to misalignment. The performance of the product may not be brought out. If an adopted land pattern is different from the recommended land pattern, stress to the product will increase. It may cause cracks or defective electrical characteristics of the product. Please conduct validation completely before studying adoption of this product and please judge the pros and cons of adoption of this product with taking on responsibility. (LSXN/LSXP/LLXN/LLXP) 4. As coefficients of thermal expansion between an inductor and a PCB differs, cracks may occur on a ferrite core when thermal stress is applied to them after mounting an inductor. (Please refer to the drawings below.) Please conduct validation completely before studying adoption of this product and please judge the pros and cons of adoption of this product with taking on responsibility. (LSXN/LSXP/LLXN/LLXP)

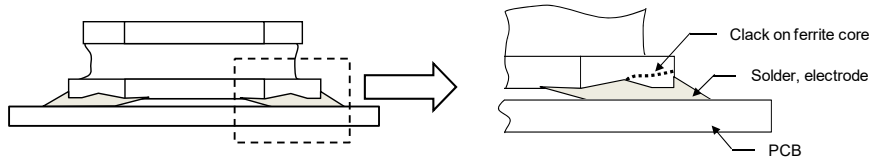

► This catalog contains the typical specification only due to the limitation of space. When you consider the purchase of our products, please check our specification. For details of each product (characteristics graph, reliability information, precautions for use, and so on), see our Web site (<http://www.ty-top.com/>)

5. SMD inductors should be located to minimize any possible mechanical stresses from board warp or deflection. When splitting the PC board after mounting inductors and other components, care is required so as not to give any stresses of deflection or twisting to the board. (LSXN/LSXP/LLXN/LLXP)

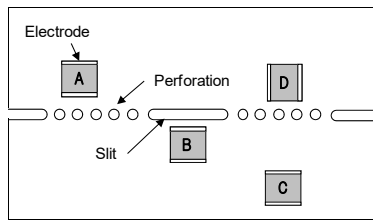

A product tends to undergo stress in order "A>C>B≡D".
Please consider the layouts of a product to minimize any stresses.

3. Considerations for automatic placement

Precautions	<ul style="list-style-type: none"> ◆ Adjustment of mounting machine 1. Excessive impact load should not be imposed on the products when mounting onto the PC boards. 2. Mounting and soldering conditions should be checked beforehand.
Technical considerations	<ul style="list-style-type: none"> ◆ Adjustment of mounting machine 1. When installing products, care should be taken not to apply distortion stress as it may deform the products. 2. Stress may be applied to a product with a warp or a twist in handling of the product. Please conduct validation completely before studying adoption of this product and please judge the pros and cons of adoption of this product with taking on responsibility. (LSXN/LSXP/LLXN/LLXP) <div style="display: flex; justify-content: space-around; align-items: center;"> <div style="text-align: center;"> <p><Wrap></p> </div> <div style="text-align: center;"> <p><Twist></p> </div> </div>

4. Soldering

Precautions	<ul style="list-style-type: none"> ◆ Reflow soldering 1. Please contact any of our offices for a reflow soldering, and refer to the recommended condition specified. 2. The product shall be used reflow soldering only. 3. Please do not add any stress to a product until it returns in normal temperature after reflow soldering. ◆ Lead free soldering 1. When using products with lead free soldering, we request to use them after confirming adhesion, temperature of resistance to soldering heat, soldering etc sufficiently. ◆ Recommended conditions for using a soldering iron (Repair) <ul style="list-style-type: none"> • Put the soldering iron on the land-pattern. • Soldering iron's temperature - Below 350°C • Duration - 3 seconds or less • The soldering iron should not directly touch the inductor.
Technical considerations	<ul style="list-style-type: none"> ◆ Reflow soldering 1. If products are used beyond the range of the recommended conditions, heat stresses may deform the products, and consequently degrade the reliability of the products. <p style="text-align: center;">Recommended reflow condition (Pb free solder)</p>

5. Cleaning

Precautions	<ul style="list-style-type: none"> ◆ Cleaning conditions 1. Washing by supersonic waves shall be avoided.
Technical considerations	<ul style="list-style-type: none"> ◆ Cleaning conditions 1. If washed by supersonic waves, the products might be broken.

▶ This catalog contains the typical specification only due to the limitation of space. When you consider the purchase of our products, please check our specification. For details of each product (characteristics graph, reliability information, precautions for use, and so on), see our Web site (<http://www.ty-top.com/>)

6. Handling

Precautions	<ul style="list-style-type: none"> ◆ Handling <ol style="list-style-type: none"> 1. Keep the product away from all magnets and magnetic objects. ◆ Breakaway PC boards (splitting along perforations) <ol style="list-style-type: none"> 1. When splitting the PC board after mounting product, care should be taken not to give any stresses of deflection or twisting to the board. 2. Board separation should not be done manually, but by using the appropriate devices. ◆ Mechanical considerations <ol style="list-style-type: none"> 1. Please do not give the product any excessive mechanical shocks. 2. Please do not add any shock and power to a product in transportation. ◆ Pick-up pressure <ol style="list-style-type: none"> 1. Please do not push to add any pressure to a winding part. Please do not give any shock and push into a ferrite core exposure part. ◆ Packing <ol style="list-style-type: none"> 1. Please avoid accumulation of a packing box as much as possible.
Technical considerations	<ul style="list-style-type: none"> ◆ Handling <ol style="list-style-type: none"> 1. There is a case that a characteristic varies with magnetic influence. ◆ Breakaway PC boards (splitting along perforations) <ol style="list-style-type: none"> 1. The position of the product on PCBs shall be carefully considered to minimize the stress caused from splitting of the PCBs. ◆ Mechanical considerations <ol style="list-style-type: none"> 1. There is a case to be damaged by a mechanical shock. 2. There is a case to be broken by the handling in transportation. ◆ Pick-up pressure <ol style="list-style-type: none"> 1. Damage and a characteristic can vary with an excessive shock or stress. ◆ Packing <ol style="list-style-type: none"> 1. If packing boxes are accumulated, that could cause a deformation on packing tapes or a damage on the products.

7. Storage conditions

Precautions	<ul style="list-style-type: none"> ◆ Storage <ol style="list-style-type: none"> 1. To maintain the solderability of terminal electrodes and to keep the packing material in good condition, temperature and humidity in the storage area should be controlled. <ul style="list-style-type: none"> ▪ Storage conditions <ul style="list-style-type: none"> Ambient temperature : $-5\sim 40^{\circ}\text{C}$ Humidity : Below 70% RH ▪ The recommended ambient temperature is below 30°C. Even under ideal storage conditions, solderability of products electrodes may decrease as time passes. <p style="margin-left: 40px;">For this reason, product should be used within 6 months from the time of delivery.</p> <p style="margin-left: 40px;">In case of storage over 6 months, solderability shall be checked before actual usage.</p>
Technical considerations	<ul style="list-style-type: none"> ◆ Storage <ol style="list-style-type: none"> 1. Under a high temperature and humidity environment, problems such as reduced solderability caused by oxidation of terminal electrodes and deterioration of taping/packaging materials may take place.

医疗设备（国际（GHTF）第一类、第二类）用途绕线型铁氧体系功率电感器 LLXBH10050

回流焊

■ 型号标示法

*使用温度范围：-25~+105℃（包含产品本身发热）

L	L	X	B	H	1	0	0	5	0	H	L	1	0	0	M	
①	②	③	④	⑤	⑥	⑦	⑧	⑨								

①系列

代码 (1)(2)(3)(4)	
LLXB	医疗设备（国际（GHTF）第一类、第二类）用途 绕线型铁氧体系功率电感器

(1) 产品群

代码	
L	电感器

(3) 类型

代码	
X	绕线型铁氧体系 鼓型

(2) 范畴

代码	推荐设备	品质等级
L	医疗设备（国际（GHTF）第一类、第二类）	3

(4) 特效 / 特性

代码	
B	一般

②特征

代码	特征
H	底面电极（框型）

⑥包装

代码	包装
L	卷盘带装

③尺寸（L×W）

代码	尺寸（L×W）[mm]
100	10.0×9.8

⑦标称电感值

代码（例）	标称电感值 [μH]
1R3	1.3
100	10
101	100

④尺寸（H）

代码	尺寸（H）[mm]
50	5.0

※R=小数点

⑤使用温度范围

代码	使用温度范围 [°C]
H	-25~+105

⑧电感量公差

代码	电感量公差
M	±20%
N	±30%

⑨管理记号

■ 标准外型尺寸 / 标准数量

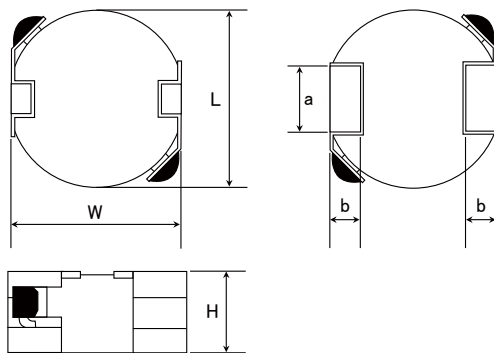

推荐焊盘图案
实装上的注意

- 请确认实装状态后使用。
- 本产品焊法限定为回流焊法。

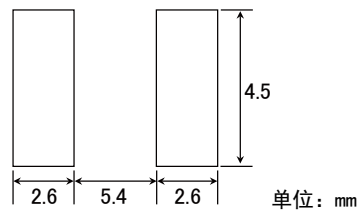

单位：mm

Type	L	W	H	a	b	标准数量 [pcs] 卷盘带装
10050	10.0±0.3 (0.394±0.012)	9.8±0.5 (0.386±0.020)	5.0 max (0.197 max)	4.0 (0.16)	1.75 (0.07)	500

单位：mm (inch)

▶ 由于篇幅有限，本产品目录中只记载了有代表性的产品规格，若考虑使用敝公司产品时，请确认交货规格说明书中的详细规格。
另外，有关各产品的详细信息（特性图、可靠性信息、使用时的注意事项等），请参阅敝公司网站（<http://www.ty-top.com/>）。

PART NUMBER

10050 type

New part number	Old part number (for reference)	EHS	Nominal inductance [μ H]	Inductance tolerance	Self-resonant frequency [MHz] (min.)	DC Resistance [Ω] ($\pm 30\%$)	Rated current ※) [mA]		Measuring frequency [kHz]
							Saturation current Idc1	Temperature rise current Idc2	
LLXBH10050HL1R3N	NR 10050T 1R3N	RoHS	1.3	$\pm 30\%$	53	0.0068	11,000	9,000	100
LLXBH10050HL2R1N	NR 10050T 2R1N	RoHS	2.1	$\pm 30\%$	37	0.0080	10,000	8,300	100
LLXBH10050HL2R9N	NR 10050T 2R9N	RoHS	2.9	$\pm 30\%$	29	0.0093	8,200	7,300	100
LLXBH10050HL3R8N	NR 10050T 3R8N	RoHS	3.8	$\pm 30\%$	26	0.013	7,300	6,800	100
LLXBH10050HL4R9N	NR 10050T 4R9N	RoHS	4.9	$\pm 30\%$	23	0.015	6,600	6,000	100
LLXBH10050HL6R5N	NR 10050T 6R5N	RoHS	6.5	$\pm 30\%$	19	0.018	6,000	5,200	100
LLXBH10050HL100M	NR 10050T 100M	RoHS	10	$\pm 20\%$	15	0.025	4,700	4,100	100
LLXBH10050HL150M	NR 10050T 150M	RoHS	15	$\pm 20\%$	11	0.035	3,600	3,200	100
LLXBH10050HL220M	NR 10050T 220M	RoHS	22	$\pm 20\%$	10	0.045	2,600	2,500	100
LLXBH10050HL330M	NR 10050T 330M	RoHS	33	$\pm 20\%$	8.2	0.066	2,500	2,100	100
LLXBH10050HL470M	NR 10050T 470M	RoHS	47	$\pm 20\%$	7.0	0.092	2,000	1,800	100
LLXBH10050HL680M	NR 10050T 680M	RoHS	68	$\pm 20\%$	5.6	0.144	1,700	1,500	100
LLXBH10050HL101M	NR 10050T 101M	RoHS	100	$\pm 20\%$	4.6	0.209	1,300	1,200	100
LLXBH10050HL221M	NR 10050T 221M	RoHS	220	$\pm 20\%$	3.0	0.450	1,000	800	100

※) The saturation current value (Idc1) is the DC current value having inductance decrease down to 30%. (at 20°C)

※) The temperature rise current value (Idc2) is the DC current value having temperature increase up to 40°C. (at 20°C)

※) The maximum rated current is the DC current value that satisfies both of current value Saturation current value and temperature rise current value. (at 20°C)

Wire-wound Ferrite Power Inductors LSXBH10050/LLXBH10050

PACKAGING

① Minimum Quantity

Type	Standard Quantity [pcs]
	Tape & Reel
10050	500

② Tape Material

● Embossed Tape

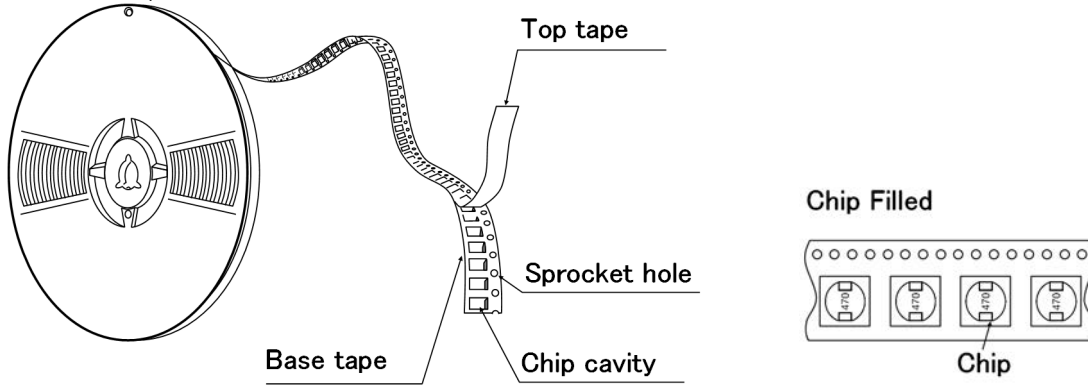

③ Taping dimensions

● Embossed tape 24mm wide (0.945 inches wide)

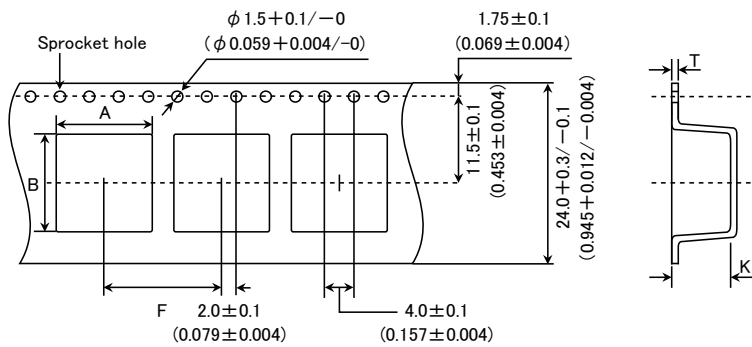

Type	Chip cavity		Insertion pitch	Tape thickness	
	A	B	F	T	K
10050	10.4 ± 0.1 (0.409 ± 0.004)	9.9 ± 0.1 (0.390 ± 0.004)	16.0 ± 0.1 (0.630 ± 0.004)	0.5 ± 0.05 (0.020 ± 0.002)	5.7 ± 0.1 (0.224 ± 0.004)

Unit: mm (inch)

④ Leader and Blank portion

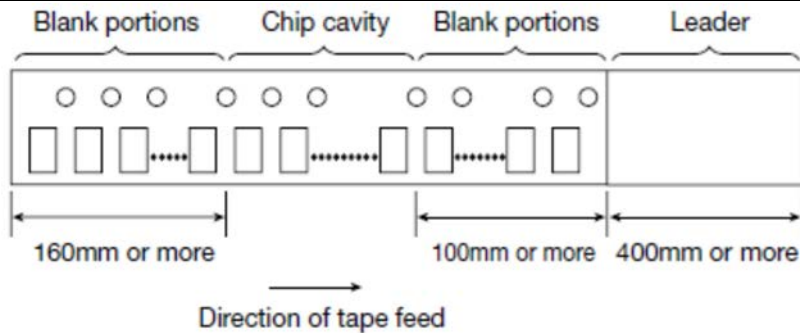

▶ This catalog contains the typical specification only due to the limitation of space. When you consider the purchase of our products, please check our specification. For details of each product (characteristics graph, reliability information, precautions for use, and so on), see our Web site (<http://www.ty-top.com/>).

⑤ Reel size

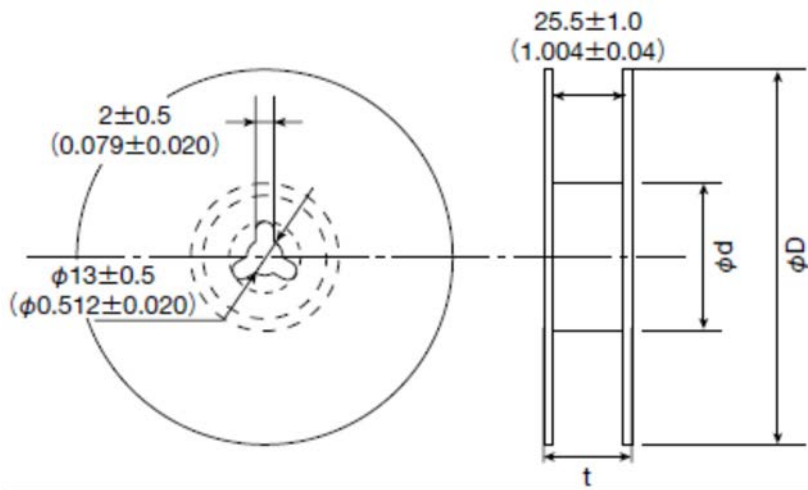

Type	Reel size (Reference value)		
	ϕD	ϕd	t (max.)
10050	330 ± 3 (12.99 ± 0.118)	80 ± 2 (3.15 ± 0.078)	30.5 (1.201)

Unit: mm (inch)

⑥ Top Tape Strength

The top tape requires a peel-off force of 0.1 to 1.3N in the direction of the arrow as illustrated below.

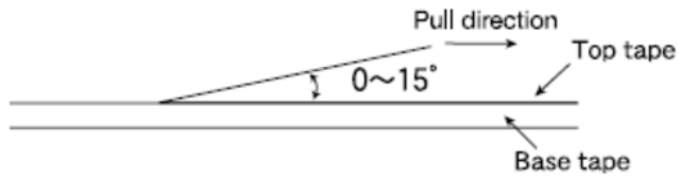

Wire-wound Ferrite Power Inductors LSXBH10050 for General Electronic Equipment for Consumer
Wire-wound Ferrite Power Inductors LLXBH10050
for Medical Devices classified as GHTF Classes A or B (Japan Classes I or II)

■ RELIABILITY DATA

1. Operating Temperature Range													
Specified Value	-25~+105°C												
Test Methods and Remarks	Including self-generated heat												
2. Storage Temperature Range													
Specified Value	-40~+85°C												
Test Methods and Remarks	-5 to 40°C for the product with taping.												
3. Rated current													
Specified Value	Within the specified tolerance												
4. Inductance													
Specified Value	Within the specified tolerance												
Test Methods and Remarks	Measuring equipment : LCR Meter (HP 4263A or equivalent) Measuring frequency : 100kHz, 1V												
5. DC Resistance													
Specified Value	Within the specified tolerance												
Test Methods and Remarks	Measuring equipment : DC ohmmeter (HIOKI 3227 or equivalent)												
6. Self resonance frequency													
Specified Value	Within the specified tolerance												
Test Methods and Remarks	Measuring equipment : Impedance analyzer/material analyzer (HP4291A or equivalent HP4191A, 4192A or equivalent)												
7. Temperature characteristic													
Specified Value	Inductance change : Within $\pm 20\%$												
Test Methods and Remarks	Measurement of inductance shall be taken at temperature range within $-25^{\circ}\text{C}\sim +85^{\circ}\text{C}$. With reference to inductance value at $+20^{\circ}\text{C}$., change rate shall be calculated. Change of maximum inductance deviation in step 1 to 5 <table border="1"> <thead> <tr> <th>Step</th> <th>Temperature (°C)</th> </tr> </thead> <tbody> <tr> <td>1</td> <td>20</td> </tr> <tr> <td>2</td> <td>Minimum operating temperature</td> </tr> <tr> <td>3</td> <td>20 (Standard temperature)</td> </tr> <tr> <td>4</td> <td>Maximum operating temperature</td> </tr> <tr> <td>5</td> <td>20</td> </tr> </tbody> </table>	Step	Temperature (°C)	1	20	2	Minimum operating temperature	3	20 (Standard temperature)	4	Maximum operating temperature	5	20
Step	Temperature (°C)												
1	20												
2	Minimum operating temperature												
3	20 (Standard temperature)												
4	Maximum operating temperature												
5	20												
8. Resistance to flexure of substrate													
Specified Value	—												
9. Insulation resistance : between wires													
Specified Value	—												
10. Insulation resistance : between wire and core													
Specified Value	—												

▶ This catalog contains the typical specification only due to the limitation of space. When you consider the purchase of our products, please check our specification.
 For details of each product (characteristics graph, reliability information, precautions for use, and so on), see our Web site (<http://www.ty-top.com/>).

11. Withstanding voltage : between wire and core																			
Specified Value	—																		
12. Adhesion of terminal electrode																			
Specified Value	Shall not come off PC board																		
Test Methods and Remarks	Applied force : 5N to X and Y directions. Duration : 5s.																		
13. Resistance to vibration																			
Specified Value	Inductance change : Within $\pm 10\%$ No significant abnormality in appearance.																		
Test Methods and Remarks	The test samples shall be soldered to the test board by the reflow. Then it shall be submitted to below test conditions.																		
	<table border="1"> <tr> <td>Frequency Range</td> <td>10~55Hz</td> </tr> <tr> <td>Total Amplitude</td> <td>1.5mm (May not exceed acceleration 196m/s²)</td> </tr> <tr> <td>Sweeping Method</td> <td>10Hz to 55Hz to 10Hz for 1min.</td> </tr> <tr> <td rowspan="3">Time</td> <td>X</td> </tr> <tr> <td>Y</td> </tr> <tr> <td>Z</td> </tr> </table>	Frequency Range	10~55Hz	Total Amplitude	1.5mm (May not exceed acceleration 196m/s ²)	Sweeping Method	10Hz to 55Hz to 10Hz for 1min.	Time	X	Y	Z								
	Frequency Range	10~55Hz																	
	Total Amplitude	1.5mm (May not exceed acceleration 196m/s ²)																	
	Sweeping Method	10Hz to 55Hz to 10Hz for 1min.																	
Time	X																		
	Y																		
	Z																		
	For 2 hours on each X, Y, and Z axis.																		
	Recovery : At least 2hrs of recovery under the standard condition after the test, followed by the measurement within 48hrs.																		
14. Solderability																			
Specified Value	At least 90% of surface of terminal electrode is covered by new solder.																		
Test Methods and Remarks	The test samples shall be dipped in flux, and then immersed in molten solder as shown in below table. Flux : Ethanol solution containing rosin 25%.																		
	<table border="1"> <tr> <td>Solder Temperature</td> <td>245\pm5$^{\circ}$C</td> </tr> <tr> <td>Time</td> <td>5\pm1.0 sec.</td> </tr> </table>	Solder Temperature	245 \pm 5 $^{\circ}$ C	Time	5 \pm 1.0 sec.														
	Solder Temperature	245 \pm 5 $^{\circ}$ C																	
	Time	5 \pm 1.0 sec.																	
	※Immersion depth : All sides of mounting terminal shall be immersed.																		
15. Resistance to soldering heat																			
Specified Value	Inductance change : Within $\pm 10\%$ No significant abnormality in appearance.																		
Test Methods and Remarks	The test sample shall be exposed to reflow oven at 230 \pm 5 $^{\circ}$ C for 40 seconds, with peak temperature at 260 \pm 5 $^{\circ}$ C for 5 seconds, 2 times. Test board material : Glass epoxy-resin Test board thickness : 1.6mm Recovery : At least 2hrs of recovery under the standard condition after the test, followed by the measurement within 48hrs.																		
16. Thermal shock																			
Specified Value	Inductance change : Within $\pm 10\%$ No significant abnormality in appearance.																		
Test Methods and Remarks	The test samples shall be soldered to the test board by the reflow. The test samples shall be placed at specified temperature for specified time by step 1 to step 4 as shown in below table in sequence. The temperature cycle shall be repeated 100 cycles.																		
	<table border="1"> <thead> <tr> <th colspan="3">Conditions of 1 cycle</th> </tr> <tr> <th>Step</th> <th>Temperature ($^{\circ}$C)</th> <th>Duration (min)</th> </tr> </thead> <tbody> <tr> <td>1</td> <td>-40\pm3</td> <td>30\pm3</td> </tr> <tr> <td>2</td> <td>Room temperature</td> <td>Within 3</td> </tr> <tr> <td>3</td> <td>+85\pm2</td> <td>30\pm3</td> </tr> <tr> <td>4</td> <td>Room temperature</td> <td>Within 3</td> </tr> </tbody> </table>	Conditions of 1 cycle			Step	Temperature ($^{\circ}$ C)	Duration (min)	1	-40 \pm 3	30 \pm 3	2	Room temperature	Within 3	3	+85 \pm 2	30 \pm 3	4	Room temperature	Within 3
	Conditions of 1 cycle																		
	Step	Temperature ($^{\circ}$ C)	Duration (min)																
	1	-40 \pm 3	30 \pm 3																
	2	Room temperature	Within 3																
3	+85 \pm 2	30 \pm 3																	
4	Room temperature	Within 3																	
	Recovery : At least 2hrs of recovery under the standard condition after the test, followed by the measurement within 48hrs.																		
17. Damp heat																			
Specified Value	—																		

18. Loading under damp heat

Specified Value	Inductance change : Within $\pm 10\%$ No significant abnormality in appearance.								
Test Methods and Remarks	The test samples shall be soldered to the test board by the reflow. The test samples shall be placed in thermostatic oven set at specified temperature and humidity and applied the rated current continuously as shown in below table.								
	<table border="1"> <tr> <td>Temperature</td> <td>$60 \pm 2^\circ\text{C}$</td> </tr> <tr> <td>Humidity</td> <td>90~95%RH</td> </tr> <tr> <td>Applied current</td> <td>Rated current</td> </tr> <tr> <td>Time</td> <td>500+24/-0 hour</td> </tr> </table>	Temperature	$60 \pm 2^\circ\text{C}$	Humidity	90~95%RH	Applied current	Rated current	Time	500+24/-0 hour
	Temperature	$60 \pm 2^\circ\text{C}$							
	Humidity	90~95%RH							
	Applied current	Rated current							
Time	500+24/-0 hour								
Recovery : At least 2hrs of recovery under the standard condition after the test, followed by the measurement within 48hrs.									

19. Low temperature life test

Specified Value	Inductance change : Within $\pm 10\%$ No significant abnormality in appearance.				
Test Methods and Remarks	The test samples shall be soldered to the test board by the reflow. After that, the test samples shall be placed at test conditions as shown in below table.				
	<table border="1"> <tr> <td>Temperature</td> <td>$-40 \pm 2^\circ\text{C}$</td> </tr> <tr> <td>Time</td> <td>500+24/-0 hour</td> </tr> </table>	Temperature	$-40 \pm 2^\circ\text{C}$	Time	500+24/-0 hour
	Temperature	$-40 \pm 2^\circ\text{C}$			
	Time	500+24/-0 hour			
Recovery : At least 2hrs of recovery under the standard condition after the test, followed by the measurement within 48hrs.					

20. High temperature life test

Specified Value	—				
Test Methods and Remarks	<table border="1"> <tr> <td>Temperature</td> <td>$105 \pm 3^\circ\text{C}$</td> </tr> <tr> <td>Time</td> <td>500+24/-0 hour</td> </tr> </table>	Temperature	$105 \pm 3^\circ\text{C}$	Time	500+24/-0 hour
	Temperature	$105 \pm 3^\circ\text{C}$			
	Time	500+24/-0 hour			
Recovery : At least 2hrs of recovery under the standard condition after the test, followed by the measurement within 48hrs.					

21. Loading at high temperature life test

Specified Value	—
-----------------	---

22. Standard condition

Specified Value	Standard test condition : Unless otherwise specified, temperature is $20 \pm 15^\circ\text{C}$ and $65 \pm 20\%$ of relative humidity. When there is any question concerning measurement result: In order to provide correlation data, the test shall be condition of $20 \pm 2^\circ\text{C}$ of temperature, $65 \pm 5\%$ relative humidity. Inductance is in accordance with our measured value.
-----------------	--

Wire-wound Ferrite Power Inductors LSXN/LSXP series

for General Electronic Equipment for Consumer

Wire-wound Ferrite Power Inductors LSXBH10050 for General Electronic Equipment for Consumer

Wire-wound Ferrite Power Inductors LSRN series for General Electronic Equipment for Consumer

Wire-wound Ferrite Power Inductors LLXN/LLXP series

for Medical Devices classified as GHTF Classes A or B (Japan Classes I or II)

Wire-wound Ferrite Power Inductors LLXBH10050

for Medical Devices classified as GHTF Classes A or B (Japan Classes I or II)

Wire-wound Ferrite Power Inductors LLRN series

for Medical Devices classified as GHTF Classes A or B (Japan Classes I or II)

■ PRECAUTIONS

1. Circuit Design

Precautions	<ul style="list-style-type: none"> ◆ Verification of operating environment, electrical rating and performance <ol style="list-style-type: none"> 1. A malfunction in medical equipment, spacecraft, nuclear reactors, etc. may cause serious harm to human life or have severe social ramifications. As such, any inductors to be used in such equipment may require higher safety and/or reliability considerations and should be clearly differentiated from components used in general purpose applications. 2. When inductors are used in places where dew condensation develops and/or where corrosive gas such as hydrogen sulfide, sulfurous acid, or chlorine exists in the air, characteristic deterioration may occur. Please do not use inductors under such environmental conditions. ◆ Operating Current (Verification of Rated current) <ol style="list-style-type: none"> 1. The operating current including inrush current for inductors must always be lower than their rated values. 2. Do not apply current in excess of the rated value because the inductance may be reduced due to the magnetic saturation effect. ◆ Temperature rise <p>Temperature rise of power choke coil depends on the installation condition in end products.</p> <p>Make sure that temperature rise of power choke coils in actual end products is within the specified temperature range.</p>
-------------	--

2. PCB Design

Precautions	<ul style="list-style-type: none"> ◆ Land pattern design <ol style="list-style-type: none"> 1. Please refer to a recommended land pattern. 2. There is stress, which has been caused by distortion of a PCB, to the inductor. (LSXN/LSXP/LLXN/LLXP) 3. Please consider the arrangement of parts on a PCB. (LSXN/LSXP/LLXN/LLXP)
Technical considerations	<ul style="list-style-type: none"> ◆ Land pattern design <p>Surface Mounting</p> <ol style="list-style-type: none"> 1. Mounting and soldering conditions should be checked beforehand. 2. Applicable soldering process to this products is reflow soldering only. 3. Please use the recommended land pattern shown as below. Electrical characteristics and the mounting ability of the product are being considered in the recommended land pattern. If a PCB is designed with other dimensions, defective soldering and stress to a product may occur due to misalignment. The performance of the product may not be brought out. If an adopted land pattern is different from the recommended land pattern, stress to the product will increase. It may cause cracks or defective electrical characteristics of the product. Please conduct validation completely before studying adoption of this product and please judge the pros and cons of adoption of this product with taking on responsibility. (LSXN/LSXP/LLXN/LLXP) 4. As coefficients of thermal expansion between an inductor and a PCB differs, cracks may occur on a ferrite core when thermal stress is applied to them after mounting an inductor. (Please refer to the drawings below.) Please conduct validation completely before studying adoption of this product and please judge the pros and cons of adoption of this product with taking on responsibility. (LSXN/LSXP/LLXN/LLXP)

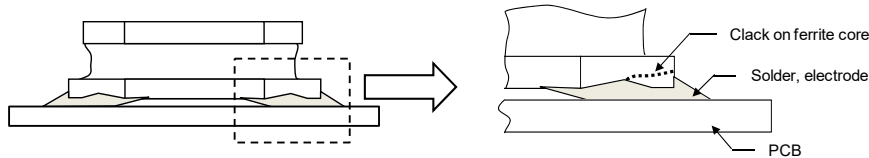

► This catalog contains the typical specification only due to the limitation of space. When you consider the purchase of our products, please check our specification. For details of each product (characteristics graph, reliability information, precautions for use, and so on), see our Web site (<http://www.ty-top.com/>)

5. SMD inductors should be located to minimize any possible mechanical stresses from board warp or deflection. When splitting the PC board after mounting inductors and other components, care is required so as not to give any stresses of deflection or twisting to the board. (LSXN/LSXP/LLXN/LLXP)

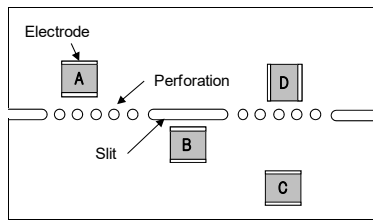

A product tends to undergo stress in order "A>C>B≡D". Please consider the layouts of a product to minimize any stresses.

3. Considerations for automatic placement

Precautions	<ul style="list-style-type: none"> ◆ Adjustment of mounting machine 1. Excessive impact load should not be imposed on the products when mounting onto the PC boards. 2. Mounting and soldering conditions should be checked beforehand.
Technical considerations	<ul style="list-style-type: none"> ◆ Adjustment of mounting machine 1. When installing products, care should be taken not to apply distortion stress as it may deform the products. 2. Stress may be applied to a product with a warp or a twist in handling of the product. Please conduct validation completely before studying adoption of this product and please judge the pros and cons of adoption of this product with taking on responsibility. (LSXN/LSXP/LLXN/LLXP) <div style="display: flex; justify-content: space-around; align-items: center;"> <div style="text-align: center;"> <p><Wrap></p> </div> <div style="text-align: center;"> <p><Twist></p> </div> </div>

4. Soldering

Precautions	<ul style="list-style-type: none"> ◆ Reflow soldering 1. Please contact any of our offices for a reflow soldering, and refer to the recommended condition specified. 2. The product shall be used reflow soldering only. 3. Please do not add any stress to a product until it returns in normal temperature after reflow soldering. ◆ Lead free soldering 1. When using products with lead free soldering, we request to use them after confirming adhesion, temperature of resistance to soldering heat, soldering etc sufficiently. ◆ Recommended conditions for using a soldering iron (Repair) <ul style="list-style-type: none"> • Put the soldering iron on the land-pattern. • Soldering iron's temperature - Below 350°C • Duration - 3 seconds or less • The soldering iron should not directly touch the inductor.
Technical considerations	<ul style="list-style-type: none"> ◆ Reflow soldering 1. If products are used beyond the range of the recommended conditions, heat stresses may deform the products, and consequently degrade the reliability of the products. <p style="text-align: center;">Recommended reflow condition (Pb free solder)</p>

5. Cleaning

Precautions	<ul style="list-style-type: none"> ◆ Cleaning conditions 1. Washing by supersonic waves shall be avoided.
Technical considerations	<ul style="list-style-type: none"> ◆ Cleaning conditions 1. If washed by supersonic waves, the products might be broken.

▶ This catalog contains the typical specification only due to the limitation of space. When you consider the purchase of our products, please check our specification. For details of each product (characteristics graph, reliability information, precautions for use, and so on), see our Web site (<http://www.ty-top.com/>)

6. Handling

Precautions	<ul style="list-style-type: none"> ◆ Handling <ol style="list-style-type: none"> 1. Keep the product away from all magnets and magnetic objects. ◆ Breakaway PC boards (splitting along perforations) <ol style="list-style-type: none"> 1. When splitting the PC board after mounting product, care should be taken not to give any stresses of deflection or twisting to the board. 2. Board separation should not be done manually, but by using the appropriate devices. ◆ Mechanical considerations <ol style="list-style-type: none"> 1. Please do not give the product any excessive mechanical shocks. 2. Please do not add any shock and power to a product in transportation. ◆ Pick-up pressure <ol style="list-style-type: none"> 1. Please do not push to add any pressure to a winding part. Please do not give any shock and push into a ferrite core exposure part. ◆ Packing <ol style="list-style-type: none"> 1. Please avoid accumulation of a packing box as much as possible.
Technical considerations	<ul style="list-style-type: none"> ◆ Handling <ol style="list-style-type: none"> 1. There is a case that a characteristic varies with magnetic influence. ◆ Breakaway PC boards (splitting along perforations) <ol style="list-style-type: none"> 1. The position of the product on PCBs shall be carefully considered to minimize the stress caused from splitting of the PCBs. ◆ Mechanical considerations <ol style="list-style-type: none"> 1. There is a case to be damaged by a mechanical shock. 2. There is a case to be broken by the handling in transportation. ◆ Pick-up pressure <ol style="list-style-type: none"> 1. Damage and a characteristic can vary with an excessive shock or stress. ◆ Packing <ol style="list-style-type: none"> 1. If packing boxes are accumulated, that could cause a deformation on packing tapes or a damage on the products.

7. Storage conditions

Precautions	<ul style="list-style-type: none"> ◆ Storage <ol style="list-style-type: none"> 1. To maintain the solderability of terminal electrodes and to keep the packing material in good condition, temperature and humidity in the storage area should be controlled. <ul style="list-style-type: none"> ▪ Storage conditions <ul style="list-style-type: none"> Ambient temperature : $-5\sim 40^{\circ}\text{C}$ Humidity : Below 70% RH ▪ The recommended ambient temperature is below 30°C. Even under ideal storage conditions, solderability of products electrodes may decrease as time passes. <p style="margin-left: 40px;">For this reason, product should be used within 6 months from the time of delivery.</p> <p style="margin-left: 40px;">In case of storage over 6 months, solderability shall be checked before actual usage.</p>
Technical considerations	<ul style="list-style-type: none"> ◆ Storage <ol style="list-style-type: none"> 1. Under a high temperature and humidity environment, problems such as reduced solderability caused by oxidation of terminal electrodes and deterioration of taping/packaging materials may take place.

医疗设备（国际（GHTF）第一类、第二类）用途 绕线型铁氧体系功率电感器 LLRN 系列

系列前的记号来自型号，用来区分产品的种类和特性等。

回流焊

■ 型号标示法

*使用温度范围：-40~+125℃（包含产品本身发热）

L	L	R	N	J	1	0	1	4	5	G	L	1	0	0	M	
①	②	③	④	⑤	⑥	⑦	⑧	⑨								

① 系列

代码 (1)(2)(3)(4)	
LLRN	医疗设备（国际（GHTF）第一类、第二类）用途绕线型铁氧体系功率电感器

(1) 产品群

代码	
L	电感器

(3) 类型

代码	
R	绕线型铁氧体系 鼓形筒状固定夹座型

(2) 范畴

代码	推荐设备	品质等级
L	医疗设备（国际（GHTF）第一类、第二类）	3

(4) 特效 / 特性

代码	
N	一般功率扼流

② 特征

代码	特征
J	底面电极（固定夹座型）

⑥ 包装

代码	包装
L	卷盘带装

③ 尺寸 (L×W)

代码	尺寸 (L×W) [mm]
101	10.1×10.1
125	12.5×12.5

⑦ 标称电感值

代码 (例)	标称电感值 [μH]
1R0	1.0
100	10
101	100

※R=小数点

④ 尺寸 (H)

代码	尺寸 (H) [mm]
45	4.5
55	5.5
65	6.5
75	7.5

⑧ 电感量公差

代码	电感量公差
M	±20%
N	±30%

⑤ 使用温度范围

代码	使用温度范围 [°C]
G	-40~+125

⑨ 管理记号

▶ 由于篇幅有限，本产品目录中只记载了有代表性的产品规格，若考虑使用敝公司产品时，请确认交货规格说明书中的详细规格。
另外，有关各产品的详细信息（特性图、可靠性信息、使用时的注意事项等），请参阅敝公司网站（<http://www.ty-top.com/>）。

■标准外型尺寸 / 最小订货单位数量

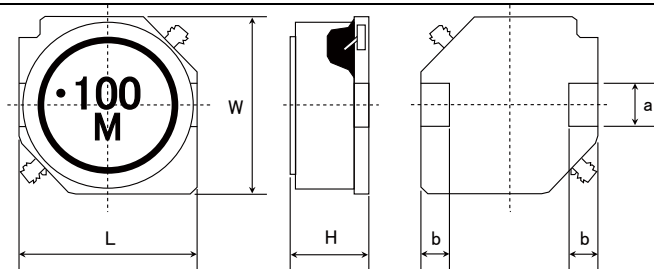

※ 101□□型没有显示生产日期标记。

Type	L	W	H	a	b	最小订货单位数量 [pcs]
10145	10.1±0.3 (0.398±0.012)	10.1±0.3 (0.398±0.012)	4.5±0.35 (0.177±0.014)	2.8±0.1 (0.110±0.004)	2.0±0.15 (0.079±0.006)	2000
10155	10.1±0.3 (0.398±0.012)	10.1±0.3 (0.398±0.012)	5.5±0.35 (0.217±0.014)	2.8±0.1 (0.110±0.004)	2.0±0.15 (0.079±0.006)	2000
10165	10.1±0.3 (0.398±0.012)	10.1±0.3 (0.398±0.012)	6.5±0.35 (0.256±0.014)	2.8±0.1 (0.110±0.004)	2.0±0.15 (0.079±0.006)	2000
12555	12.5±0.3 (0.492±0.012)	12.5±0.3 (0.492±0.012)	5.5±0.35 (0.217±0.014)	3.0±0.1 (0.118±0.004)	2.0±0.15 (0.079±0.006)	2000
12565	12.5±0.3 (0.492±0.012)	12.5±0.3 (0.492±0.012)	6.5±0.35 (0.256±0.014)	3.0±0.1 (0.118±0.004)	2.0±0.15 (0.079±0.006)	2000
12575	12.5±0.3 (0.492±0.012)	12.5±0.3 (0.492±0.012)	7.5±0.35 (0.295±0.014)	3.0±0.1 (0.118±0.004)	2.0±0.15 (0.079±0.006)	2000

单位: mm (inch)

推荐焊盘图案

実装上的注意

- 请确认实装状态后使用。
- 本产品焊法限定为回流焊法。

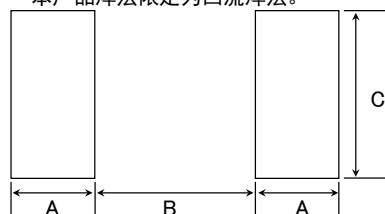

Type	A	B	C
10145	2.5	5.6	3.2
10155	2.5	5.6	3.2
10165	2.5	5.6	3.2
12555	2.5	8.6	3.2
12565	2.5	8.6	3.2
12575	2.5	8.6	3.2

单位: mm

PART NUMBER

● 10145 type								
New part number	Old part number (for reference)	EHS	Nominal inductance [μ H]	Inductance tolerance	DC Resistance [Ω]($\pm 20\%$)	Rated current ※) [A]		Measuring frequency [kHz]
						Saturation current Idc1	Temperature rise current Idc2	
LLRNJ10145GL1R0NNY	NS 10145T 1R0NNA	RoHS	1.0	$\pm 30\%$	0.0049	12.54	8.90	100
LLRNJ10145GL1R5NNY	NS 10145T 1R5NNA	RoHS	1.5	$\pm 30\%$	0.0060	10.34	7.99	100
LLRNJ10145GL2R2NNY	NS 10145T 2R2NNA	RoHS	2.2	$\pm 30\%$	0.0085	8.91	6.64	100
LLRNJ10145GL3R3NNY	NS 10145T 3R3NNA	RoHS	3.3	$\pm 30\%$	0.0100	7.33	6.10	100
LLRNJ10145GL4R7NNY	NS 10145T 4R7NNA	RoHS	4.7	$\pm 30\%$	0.0144	6.69	5.03	100
LLRNJ10145GL5R6NNY	NS 10145T 5R6NNA	RoHS	5.6	$\pm 30\%$	0.0181	5.85	4.45	100
LLRNJ10145GL6R8NNY	NS 10145T 6R8NNA	RoHS	6.8	$\pm 30\%$	0.0200	5.05	4.22	100
LLRNJ10145GL100MNY	NS 10145T 100MNA	RoHS	10	$\pm 20\%$	0.0248	4.22	3.77	100
LLRNJ10145GL150MNY	NS 10145T 150MNA	RoHS	15	$\pm 20\%$	0.0381	3.44	3.00	100
LLRNJ10145GL220MNY	NS 10145T 220MNA	RoHS	22	$\pm 20\%$	0.0520	2.87	2.55	100
LLRNJ10145GL330MNY	NS 10145T 330MNA	RoHS	33	$\pm 20\%$	0.0815	2.36	2.01	100
LLRNJ10145GL470MNY	NS 10145T 470MNA	RoHS	47	$\pm 20\%$	0.100	1.85	1.80	100
LLRNJ10145GL680MNY	NS 10145T 680MNA	RoHS	68	$\pm 20\%$	0.150	1.66	1.45	100
LLRNJ10145GL101MNY	NS 10145T 101MNA	RoHS	100	$\pm 20\%$	0.200	1.29	1.25	100
LLRNJ10145GL151MNY	NS 10145T 151MNA	RoHS	150	$\pm 20\%$	0.341	1.11	0.94	100
LLRNJ10145GL221MNY	NS 10145T 221MNA	RoHS	220	$\pm 20\%$	0.485	0.91	0.78	100
LLRNJ10145GL331MNY	NS 10145T 331MNA	RoHS	330	$\pm 20\%$	0.700	0.71	0.64	100
LLRNJ10145GL471MNY	NS 10145T 471MNA	RoHS	470	$\pm 20\%$	1.030	0.61	0.52	100
LLRNJ10145GL681MNY	NS 10145T 681MNA	RoHS	680	$\pm 20\%$	1.57	0.50	0.42	100
LLRNJ10145GL102MNY	NS 10145T 102MNA	RoHS	1000	$\pm 20\%$	2.58	0.41	0.32	100
LLRNJ10145GL152MNY	NS 10145T 152MNA	RoHS	1500	$\pm 20\%$	3.70	0.36	0.27	100

● 10155 type								
New part number	Old part number (for reference)	EHS	Nominal inductance [μ H]	Inductance tolerance	DC Resistance [Ω]($\pm 20\%$)	Rated current ※) [A]		Measuring frequency [kHz]
						Saturation current Idc1	Temperature rise current Idc2	
LLRNJ10155GL1R5NNY	NS 10155T 1R5NNA	RoHS	1.5	$\pm 30\%$	0.0060	11.90	8.39	100
LLRNJ10155GL2R2NNY	NS 10155T 2R2NNA	RoHS	2.2	$\pm 30\%$	0.0072	10.00	7.61	100
LLRNJ10155GL3R3NNY	NS 10155T 3R3NNA	RoHS	3.3	$\pm 30\%$	0.0097	8.50	6.49	100
LLRNJ10155GL4R7NNY	NS 10155T 4R7NNA	RoHS	4.7	$\pm 30\%$	0.0112	7.40	6.01	100
LLRNJ10155GL6R8NNY	NS 10155T 6R8NNA	RoHS	6.8	$\pm 30\%$	0.0159	6.00	4.98	100
LLRNJ10155GL100MNY	NS 10155T 100MNA	RoHS	10	$\pm 20\%$	0.0200	4.49	4.40	100
LLRNJ10155GL150MNY	NS 10155T 150MNA	RoHS	15	$\pm 20\%$	0.0284	4.03	3.65	100
LLRNJ10155GL220MNY	NS 10155T 220MNA	RoHS	22	$\pm 20\%$	0.0380	3.37	3.12	100

● 10165 type								
New part number	Old part number (for reference)	EHS	Nominal inductance [μ H]	Inductance tolerance	DC Resistance [Ω]($\pm 20\%$)	Rated current ※) [A]		Measuring frequency [kHz]
						Saturation current Idc1	Temperature rise current Idc2	
LLRNJ10165GL1R5NNY	NS 10165T 1R5NNA	RoHS	1.5	$\pm 30\%$	0.0062	13.60	8.04	100
LLRNJ10165GL2R2NNY	NS 10165T 2R2NNA	RoHS	2.2	$\pm 30\%$	0.0074	10.80	7.32	100
LLRNJ10165GL3R3NNY	NS 10165T 3R3NNA	RoHS	3.3	$\pm 30\%$	0.0086	9.30	6.76	100
LLRNJ10165GL4R7NNY	NS 10165T 4R7NNA	RoHS	4.7	$\pm 30\%$	0.0112	7.70	5.88	100
LLRNJ10165GL6R8NNY	NS 10165T 6R8NNA	RoHS	6.8	$\pm 30\%$	0.0140	6.00	5.22	100
LLRNJ10165GL100MNY	NS 10165T 100MNA	RoHS	10	$\pm 20\%$	0.0174	5.20	4.66	100
LLRNJ10165GL150MNY	NS 10165T 150MNA	RoHS	15	$\pm 20\%$	0.0250	4.50	3.84	100
LLRNJ10165GL220MNY	NS 10165T 220MNA	RoHS	22	$\pm 20\%$	0.0313	3.60	3.41	100

● 12555 type								
New part number	Old part number (for reference)	EHS	Nominal inductance [μ H]	Inductance tolerance	DC Resistance [Ω]($\pm 20\%$)	Rated current ※) [A]		Measuring frequency [kHz]
						Saturation current Idc1	Temperature rise current Idc2	
LLRNJ12555GL6R0NMY	NS 12555T 6R0NN	RoHS	6.0	$\pm 30\%$	0.0140	5.01	5.60	100
LLRNJ12555GL100MNY	NS 12555T 100MN	RoHS	10	$\pm 20\%$	0.0175	4.73	5.04	100
LLRNJ12555GL150MNY	NS 12555T 150MN	RoHS	15	$\pm 20\%$	0.0233	3.89	4.18	100
LLRNJ12555GL220MNY	NS 12555T 220MN	RoHS	22	$\pm 20\%$	0.0297	3.20	3.81	100
LLRNJ12555GL330MNY	NS 12555T 330MN	RoHS	33	$\pm 20\%$	0.0415	2.64	3.16	100
LLRNJ12555GL470MNY	NS 12555T 470MN	RoHS	47	$\pm 20\%$	0.0551	2.23	2.70	100
LLRNJ12555GL680MNY	NS 12555T 680MN	RoHS	68	$\pm 20\%$	0.0797	1.81	2.14	100
LLRNJ12555GL101MNY	NS 12555T 101MN	RoHS	100	$\pm 20\%$	0.117	1.53	1.86	100
LLRNJ12555GL151MNY	NS 12555T 151MN	RoHS	150	$\pm 20\%$	0.176	1.22	1.43	100
LLRNJ12555GL221MNY	NS 12555T 221MN	RoHS	220	$\pm 20\%$	0.270	1.00	1.18	100
LLRNJ12555GL331MNY	NS 12555T 331MN	RoHS	330	$\pm 20\%$	0.410	0.82	0.96	100
LLRNJ12555GL471MNY	NS 12555T 471MN	RoHS	470	$\pm 20\%$	0.520	0.68	0.80	100
LLRNJ12555GL681MNY	NS 12555T 681MN	RoHS	680	$\pm 20\%$	0.760	0.60	0.72	100
LLRNJ12555GL102MNY	NS 12555T 102MN	RoHS	1000	$\pm 20\%$	1.12	0.47	0.59	100
LLRNJ12555GL152MNY	NS 12555T 152MN	RoHS	1500	$\pm 20\%$	1.73	0.40	0.44	100

※) The saturation current value (Idc1) is the DC current value having inductance decrease down to 30%. (at 20°C)

※) The temperature rise current value (Idc2) is the DC current value having temperature increase up to 40°C. (at 20°C)

※) The rated current is the DC current value that satisfies both of current value saturation current value and temperature rise current value.

PART NUMBER

● 12565 type								
New part number	Old part number (for reference)	EHS	Nominal inductance [μ H]	Inductance tolerance	DC Resistance [Ω]($\pm 20\%$)	Rated current ※) [A]		Measuring frequency [kHz]
						Saturation current Idc1	Temperature rise current Idc2	
LLRNJ12565GL2R0NMY	NS 12565T 2R0NN	RoHS	2.0	$\pm 30\%$	0.0080	13.91	7.60	100
LLRNJ12565GL4R2NMY	NS 12565T 4R2NN	RoHS	4.2	$\pm 30\%$	0.0126	10.15	5.91	100
LLRNJ12565GL7R0NMY	NS 12565T 7R0NN	RoHS	7.0	$\pm 30\%$	0.0162	7.93	5.21	100
LLRNJ12565GL100MMY	NS 12565T 100MN	RoHS	10	$\pm 20\%$	0.0199	6.96	4.75	100
LLRNJ12565GL150MMY	NS 12565T 150MN	RoHS	15	$\pm 20\%$	0.0237	5.84	4.33	100
LLRNJ12565GL220MMY	NS 12565T 220MN	RoHS	22	$\pm 20\%$	0.0310	4.87	3.91	100
LLRNJ12565GL330MMY	NS 12565T 330MN	RoHS	33	$\pm 20\%$	0.0390	3.89	3.22	100
LLRNJ12565GL470MMY	NS 12565T 470MN	RoHS	47	$\pm 20\%$	0.0575	3.34	2.78	100
LLRNJ12565GL680MMY	NS 12565T 680MN	RoHS	68	$\pm 20\%$	0.0775	2.78	2.30	100
LLRNJ12565GL101IMMY	NS 12565T 101MN	RoHS	100	$\pm 20\%$	0.123	2.23	1.81	100
LLRNJ12565GL151IMMY	NS 12565T 151MN	RoHS	150	$\pm 20\%$	0.173	1.84	1.54	100
LLRNJ12565GL221IMMY	NS 12565T 221MN	RoHS	220	$\pm 20\%$	0.273	1.39	1.18	100

● 12575 type								
New part number	Old part number (for reference)	EHS	Nominal inductance [μ H]	Inductance tolerance	DC Resistance [Ω]($\pm 20\%$)	Rated current ※) [A]		Measuring frequency [kHz]
						Saturation current Idc1	Temperature rise current Idc2	
LLRNJ12575GL1R2NMY	NS 12575T 1R2NN	RoHS	1.2	$\pm 30\%$	0.0058	18.08	9.15	100
LLRNJ12575GL2R7NMY	NS 12575T 2R7NN	RoHS	2.7	$\pm 30\%$	0.0085	13.91	7.69	100
LLRNJ12575GL3R9NMY	NS 12575T 3R9NN	RoHS	3.9	$\pm 30\%$	0.0099	12.52	7.38	100
LLRNJ12575GL5R6NMY	NS 12575T 5R6NN	RoHS	5.6	$\pm 30\%$	0.0116	10.85	6.36	100
LLRNJ12575GL6R8NMY	NS 12575T 6R8NN	RoHS	6.8	$\pm 30\%$	0.0131	10.02	5.84	100
LLRNJ12575GL100MMY	NS 12575T 100MN	RoHS	10	$\pm 20\%$	0.0156	7.65	5.55	100
LLRNJ12575GL150MMY	NS 12575T 150MN	RoHS	15	$\pm 20\%$	0.0184	6.54	5.22	100
LLRNJ12575GL220MMY	NS 12575T 220MN	RoHS	22	$\pm 20\%$	0.0260	5.56	4.05	100
LLRNJ12575GL330MMY	NS 12575T 330MN	RoHS	33	$\pm 20\%$	0.0390	4.45	3.48	100
LLRNJ12575GL470MMY	NS 12575T 470MN	RoHS	47	$\pm 20\%$	0.0515	3.76	2.95	100
LLRNJ12575GL680MMY	NS 12575T 680MN	RoHS	68	$\pm 20\%$	0.0720	2.78	2.49	100
LLRNJ12575GL101IMMY	NS 12575T 101MN	RoHS	100	$\pm 20\%$	0.110	2.64	2.01	100
LLRNJ12575GL151IMMY	NS 12575T 151MN	RoHS	150	$\pm 20\%$	0.161	2.09	1.51	100
LLRNJ12575GL221IMMY	NS 12575T 221MN	RoHS	220	$\pm 20\%$	0.245	1.81	1.35	100

※) The saturation current value (Idc1) is the DC current value having inductance decrease down to 30%. (at 20°C)

※) The temperature rise current value (Idc2) is the DC current value having temperature increase up to 40°C. (at 20°C)

※) The rated current is the DC current value that satisfies both of current value saturation current value and temperature rise current value.

Wire-wound Ferrite Power Inductors LSRN/LCRN/LBRN/LLRN/LMRN series

PACKAGING

① Packing Quantity

Type	Standard Quantity (1reel) [pcs]	Minimum Quantity [pcs]
	Embossed Tape	Embossed Tape
10145	500	2000
10155	500	2000
10165	500	2000
12555	500	2000
12565	500	2000
12575	500	2000

② Tape Material

● Embossed Tape

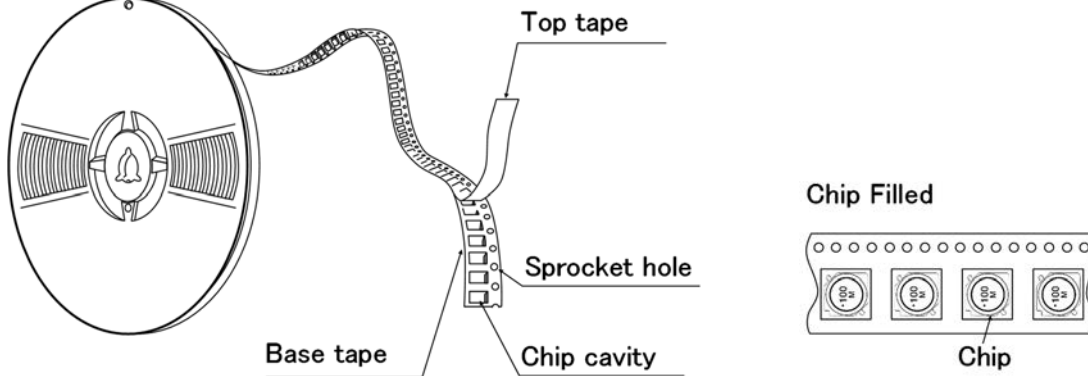

③ Taping dimensions

● Embossed tape 24mm wide (0.945 inches wide)

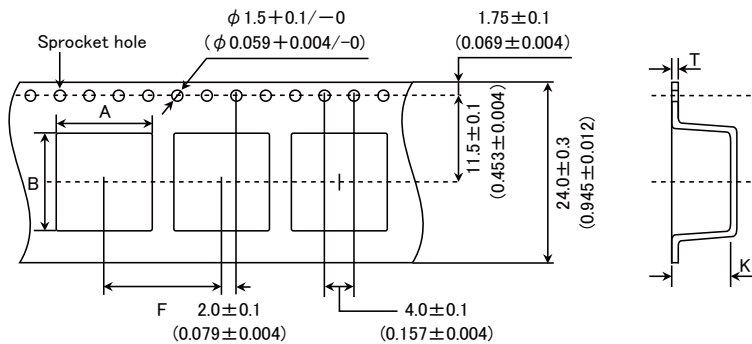

Type	Chip cavity		Insertion pitch F	Tape thickness	
	A	B		T	K
10145	10.5 ± 0.1 (0.413 ± 0.004)	10.5 ± 0.1 (0.413 ± 0.004)	16.0 ± 0.1 (0.630 ± 0.004)	0.4 ± 0.1 (0.016 ± 0.004)	5.0 ± 0.1 (0.197 ± 0.004)
10155	10.5 ± 0.1 (0.413 ± 0.004)	10.5 ± 0.1 (0.413 ± 0.004)	16.0 ± 0.1 (0.630 ± 0.004)	0.4 ± 0.1 (0.016 ± 0.004)	6.0 ± 0.1 (0.236 ± 0.004)
10165	10.5 ± 0.1 (0.413 ± 0.004)	10.5 ± 0.1 (0.413 ± 0.004)	16.0 ± 0.1 (0.630 ± 0.004)	0.4 ± 0.1 (0.016 ± 0.004)	7.0 ± 0.1 (0.276 ± 0.004)
12555	13.0 ± 0.1 (0.512 ± 0.004)	13.0 ± 0.1 (0.512 ± 0.004)	16.0 ± 0.1 (0.630 ± 0.004)	0.4 ± 0.1 (0.016 ± 0.004)	6.1 ± 0.1 (0.240 ± 0.004)
12565	13.0 ± 0.1 (0.512 ± 0.004)	13.0 ± 0.1 (0.512 ± 0.004)	16.0 ± 0.1 (0.630 ± 0.004)	0.4 ± 0.1 (0.016 ± 0.004)	7.1 ± 0.1 (0.280 ± 0.004)
12575	13.0 ± 0.1 (0.512 ± 0.004)	13.0 ± 0.1 (0.512 ± 0.004)	16.0 ± 0.1 (0.630 ± 0.004)	0.4 ± 0.1 (0.016 ± 0.004)	8.0 ± 0.1 (0.315 ± 0.004)

Unit : mm (inch)

► This catalog contains the typical specification only due to the limitation of space. When you consider the purchase of our products, please check our specification. For details of each product (characteristics graph, reliability information, precautions for use, and so on), see our Web site (<http://www.ty-top.com/>).

④ Leader and Blank portion

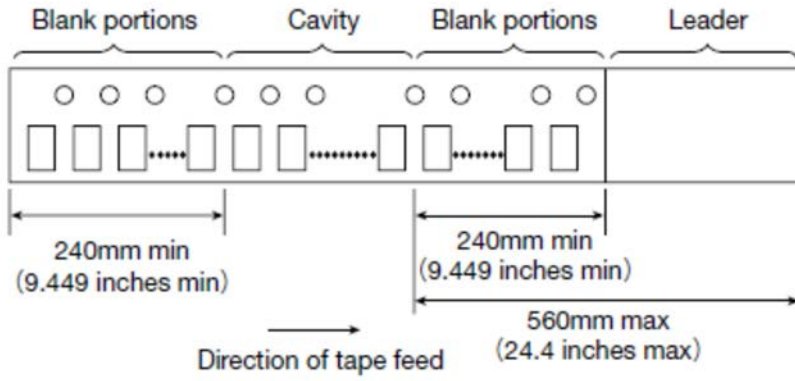

⑤ Reel size

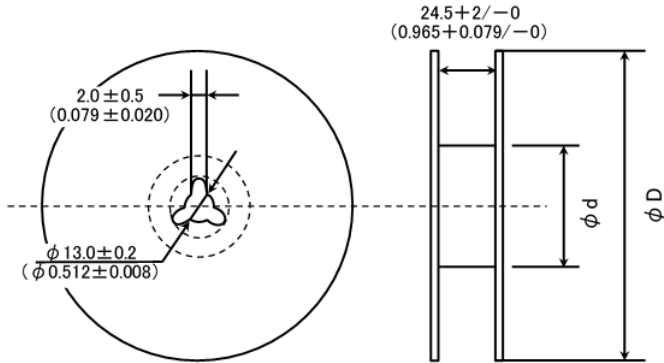

Type	Reel size (Reference values)	
	ϕD	ϕd
10145	330 ± 2 (12.99 ± 0.079)	100 ± 1 (3.937 ± 0.039)
10155		
10165		
12555		
12565		
12575		

Unit : mm (inch)

⑥ Top Tape Strength

The top tape requires a peel-off force of 0.1 to 1.3N in the direction of the arrow as illustrated below.

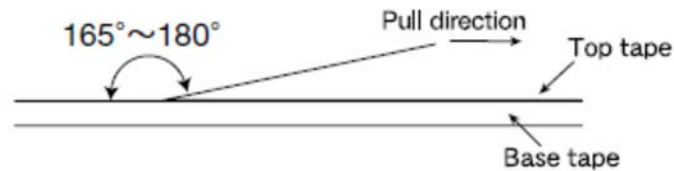

Wire-wound Ferrite Power Inductors LSRN series for General Electronic Equipment for Consumer
 Wire-wound Ferrite Power Inductors LLRN series
 for Medical Devices classified as GHTF Classes A or B (Japan Classes I or II)

■ RELIABILITY DATA

1. Operating Temperature Range													
Specified Value	-40~+125°C												
Test Methods and Remarks	Including self-generated heat												
2. Storage Temperature Range													
Specified Value	-40~+85°C												
Test Methods and Remarks	-5 to 40°C for the product with taping.												
3. Rated current													
Specified Value	Within the specified tolerance												
4. Inductance													
Specified Value	Within the specified tolerance												
Test Methods and Remarks	Measuring equipment : LCR Meter (HP 4285A or equivalent) Measuring frequency : 100kHz, 1V												
5. DC Resistance													
Specified Value	Within the specified tolerance												
Test Methods and Remarks	Measuring equipment : DC ohmmeter (HIOKI 3227 or equivalent)												
6. Self resonance frequency													
Specified Value	—												
7. Temperature characteristic													
Specified Value	Inductance change : Within $\pm 15\%$												
Test Methods and Remarks	Measurement of inductance shall be taken at temperature range within $-40^{\circ}\text{C}\sim +125^{\circ}\text{C}$. With reference to inductance value at $+20^{\circ}\text{C}$., change rate shall be calculated. Change of maximum inductance deviation in step 1 to 5												
	<table border="1"> <thead> <tr> <th>Step</th> <th>Temperature (°C)</th> </tr> </thead> <tbody> <tr> <td>1</td> <td>20</td> </tr> <tr> <td>2</td> <td>Minimum operating temperature</td> </tr> <tr> <td>3</td> <td>20 (Standard temperature)</td> </tr> <tr> <td>4</td> <td>Maximum operating temperature</td> </tr> <tr> <td>5</td> <td>20</td> </tr> </tbody> </table>	Step	Temperature (°C)	1	20	2	Minimum operating temperature	3	20 (Standard temperature)	4	Maximum operating temperature	5	20
Step	Temperature (°C)												
1	20												
2	Minimum operating temperature												
3	20 (Standard temperature)												
4	Maximum operating temperature												
5	20												

► This catalog contains the typical specification only due to the limitation of space. When you consider the purchase of our products, please check our specification.
 For details of each product (characteristics graph, reliability information, precautions for use, and so on), see our Web site (<http://www.ty-top.com/>).

8. Resistance to flexure of substrate

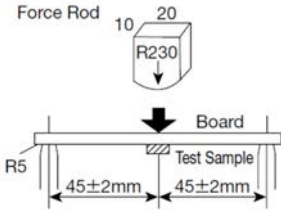
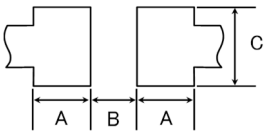
Specified Value	No damage														
Test Methods and Remarks	The test samples shall be soldered to the test board by the reflow. As illustrated below, apply force in the direction of the arrow indicating until deflection of the test board reaches to 2 mm. Test board size : 100 × 40 × 1.0 Test board material : Glass epoxy-resin Solder cream thickness : 0.15mm														
															
	Land dimension	<table border="1"> <thead> <tr> <th>Type</th> <th>A</th> <th>B</th> <th>C</th> </tr> </thead> <tbody> <tr> <td>101</td> <td>2.5</td> <td>5.6</td> <td>3.2</td> </tr> <tr> <td>125</td> <td>2.5</td> <td>8.6</td> <td>3.2</td> </tr> </tbody> </table>		Type	A	B	C	101	2.5	5.6	3.2	125	2.5	8.6	3.2
Type	A	B	C												
101	2.5	5.6	3.2												
125	2.5	8.6	3.2												
															

9. Insulation resistance : between wires

Specified Value	—
-----------------	---

10. Insulation resistance : between wire and core

Specified Value	—
-----------------	---

11. Withstanding voltage : between wire and core

Specified Value	—
-----------------	---

12. Adhesion of terminal electrode

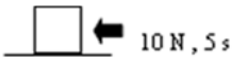
Specified Value	Shall not come off PC board		
Test Methods and Remarks	The test samples shall be soldered to the test board by the reflow. Applied force : 10N to X and Y directions. Duration : 5s. Solder cream thickness : 0.15mm		
			

13. Resistance to vibration

Specified Value	Inductance change : Within ±10% No significant abnormality in appearance.		
Test Methods and Remarks	The test samples shall be soldered to the test board by the reflow. Then it shall be submitted to below test conditions.		
	Frequency Range	10~55Hz	
	Total Amplitude	1.5mm (May not exceed acceleration 196m/s ²)	
	Sweeping Method	10Hz to 55Hz to 10Hz for 1min.	
	Time	X	For 2 hours on each X, Y, and Z axis.
		Y	
		Z	
	Recovery : At least 2hrs of recovery under the standard condition after the test, followed by the measurement within 48hrs.		

▶ This catalog contains the typical specification only due to the limitation of space. When you consider the purchase of our products, please check our specification. For details of each product (characteristics graph, reliability information, precautions for use, and so on), see our Web site (<http://www.ty-top.com/>).

14. Solderability

Specified Value	At least 90% of surface of terminal electrode is covered by new solder.	
Test Methods and Remarks	The test samples shall be dipped in flux, and then immersed in molten solder as shown in below table. Flux : Ethanol solution containing rosin 25%.	
	Solder Temperature	245±5°C
	Time	5±1.0 sec.
※Immersion depth : All sides of mounting terminal shall be immersed.		

15. Resistance to soldering heat

Specified Value	Inductance change : Within ±10% No significant abnormality in appearance.	
Test Methods and Remarks	The test sample shall be exposed to reflow oven at 230±5°C for 40 seconds, with peak temperature at 260±5°C for 5 seconds, 2 times.	
	Test board material	: Glass epoxy-resin
	Test board thickness	: 1.0mm

16. Thermal shock

Specified Value	Inductance change : Within ±10% No significant abnormality in appearance.		
Test Methods and Remarks	The test samples shall be soldered to the test board by the reflow. The test samples shall be placed at specified temperature for specified time by step 1 to step 4 as shown in below table in sequence. The temperature cycle shall be repeated 100 cycles.		
	Conditions of 1 cycle		
	Step	Temperature (°C)	Duration (min)
	1	-40±3	30±3
	2	Room temperature	Within 3
3	+85±2	30±3	
4	Room temperature	Within 3	
Recovery : At least 2hrs of recovery under the standard condition after the test, followed by the measurement within 48hrs.			

17. Damp heat

Specified Value	Inductance change : Within ±10% No significant abnormality in appearance.	
Test Methods and Remarks	The test samples shall be soldered to the test board by the reflow. The test samples shall be placed in thermostatic oven set at specified temperature and humidity as shown in below table.	
	Temperature	60±2°C
	Humidity	90~95%RH
	Time	500+24/-0 hour
Recovery : At least 2hrs of recovery under the standard condition after the test, followed by the measurement within 48hrs.		

18. Loading under damp heat

Specified Value	Inductance change : Within ±10% No significant abnormality in appearance.	
Test Methods and Remarks	The test samples shall be soldered to the test board by the reflow. The test samples shall be placed in thermostatic oven set at specified temperature and humidity and applied the rated current continuously as shown in below table.	
	Temperature	60±2°C
	Humidity	90~95%RH
	Applied current	Rated current
	Time	500+24/-0 hour
Recovery : At least 2hrs of recovery under the standard condition after the test, followed by the measurement within 48hrs.		

19. Low temperature life test

Specified Value	Inductance change : Within ±10% No significant abnormality in appearance.	
Test Methods and Remarks	The test samples shall be soldered to the test board by the reflow. After that, the test samples shall be placed at test conditions as shown in below table.	
	Temperature	-40±2°C
	Time	500+24/-0 hour
Recovery : At least 2hrs of recovery under the standard condition after the test, followed by the measurement within 48hrs.		

▶ This catalog contains the typical specification only due to the limitation of space. When you consider the purchase of our products, please check our specification.
For details of each product (characteristics graph, reliability information, precautions for use, and so on), see our Web site (<http://www.ty-top.com/>).

20. High temperature life test

Specified Value	—
-----------------	---

21. Loading at high temperature life test

Specified Value	Inductance change : Within $\pm 10\%$ No significant abnormality in appearance.	
Test Methods and Remarks	The test samples shall be soldered to the test board by the reflow soldering.	
	Temperature	$85 \pm 2^\circ\text{C}$
	Applied current	Rated current
	Time	$500 + 24 / - 0$ hour
	Recovery : At least 2hrs of recovery under the standard condition after the test, followed by the measurement within 48hrs.	

22. Standard condition

Specified Value	Standard test condition : Unless otherwise specified, temperature is $20 \pm 15^\circ\text{C}$ and $65 \pm 20\%$ of relative humidity. When there is any question concerning measurement result: In order to provide correlation data, the test shall be condition of $20 \pm 2^\circ\text{C}$ of temperature, $65 \pm 5\%$ relative humidity. Inductance is in accordance with our measured value.
-----------------	--

Wire-wound Ferrite Power Inductors LSXN/LSXP series

for General Electronic Equipment for Consumer

Wire-wound Ferrite Power Inductors LSXBH10050 for General Electronic Equipment for Consumer

Wire-wound Ferrite Power Inductors LSRN series for General Electronic Equipment for Consumer

Wire-wound Ferrite Power Inductors LLXN/LLXP series

for Medical Devices classified as GHTF Classes A or B (Japan Classes I or II)

Wire-wound Ferrite Power Inductors LLXBH10050

for Medical Devices classified as GHTF Classes A or B (Japan Classes I or II)

Wire-wound Ferrite Power Inductors LLRN series

for Medical Devices classified as GHTF Classes A or B (Japan Classes I or II)

■ PRECAUTIONS

1. Circuit Design

Precautions	<ul style="list-style-type: none"> ◆ Verification of operating environment, electrical rating and performance <ol style="list-style-type: none"> 1. A malfunction in medical equipment, spacecraft, nuclear reactors, etc. may cause serious harm to human life or have severe social ramifications. As such, any inductors to be used in such equipment may require higher safety and/or reliability considerations and should be clearly differentiated from components used in general purpose applications. 2. When inductors are used in places where dew condensation develops and/or where corrosive gas such as hydrogen sulfide, sulfurous acid, or chlorine exists in the air, characteristic deterioration may occur. Please do not use inductors under such environmental conditions. ◆ Operating Current (Verification of Rated current) <ol style="list-style-type: none"> 1. The operating current including inrush current for inductors must always be lower than their rated values. 2. Do not apply current in excess of the rated value because the inductance may be reduced due to the magnetic saturation effect. ◆ Temperature rise <p>Temperature rise of power choke coil depends on the installation condition in end products.</p> <p>Make sure that temperature rise of power choke coils in actual end products is within the specified temperature range.</p>
-------------	--

2. PCB Design

Precautions	<ul style="list-style-type: none"> ◆ Land pattern design <ol style="list-style-type: none"> 1. Please refer to a recommended land pattern. 2. There is stress, which has been caused by distortion of a PCB, to the inductor. (LSXN/LSXP/LLXN/LLXP) 3. Please consider the arrangement of parts on a PCB. (LSXN/LSXP/LLXN/LLXP)
Technical considerations	<ul style="list-style-type: none"> ◆ Land pattern design <p>Surface Mounting</p> <ol style="list-style-type: none"> 1. Mounting and soldering conditions should be checked beforehand. 2. Applicable soldering process to this products is reflow soldering only. 3. Please use the recommended land pattern shown as below. Electrical characteristics and the mounting ability of the product are being considered in the recommended land pattern. If a PCB is designed with other dimensions, defective soldering and stress to a product may occur due to misalignment. The performance of the product may not be brought out. If an adopted land pattern is different from the recommended land pattern, stress to the product will increase. It may cause cracks or defective electrical characteristics of the product. Please conduct validation completely before studying adoption of this product and please judge the pros and cons of adoption of this product with taking on responsibility. (LSXN/LSXP/LLXN/LLXP) 4. As coefficients of thermal expansion between an inductor and a PCB differs, cracks may occur on a ferrite core when thermal stress is applied to them after mounting an inductor. (Please refer to the drawings below.) Please conduct validation completely before studying adoption of this product and please judge the pros and cons of adoption of this product with taking on responsibility. (LSXN/LSXP/LLXN/LLXP)

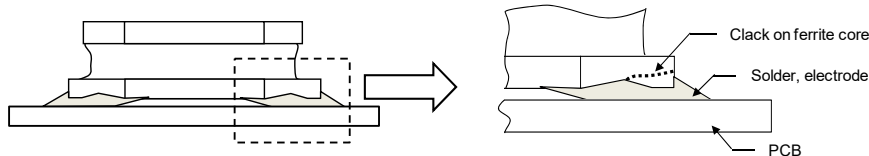

► This catalog contains the typical specification only due to the limitation of space. When you consider the purchase of our products, please check our specification. For details of each product (characteristics graph, reliability information, precautions for use, and so on), see our Web site (<http://www.ty-top.com/>)

5. SMD inductors should be located to minimize any possible mechanical stresses from board warp or deflection. When splitting the PC board after mounting inductors and other components, care is required so as not to give any stresses of deflection or twisting to the board. (LSXN/LSXP/LLXN/LLXP)

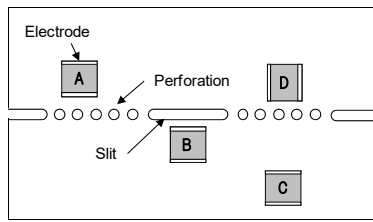

A product tends to undergo stress in order “A>C>B≡D”. Please consider the layouts of a product to minimize any stresses.

3. Considerations for automatic placement

Precautions	<ul style="list-style-type: none"> ◆ Adjustment of mounting machine 1. Excessive impact load should not be imposed on the products when mounting onto the PC boards. 2. Mounting and soldering conditions should be checked beforehand.
Technical considerations	<ul style="list-style-type: none"> ◆ Adjustment of mounting machine 1. When installing products, care should be taken not to apply distortion stress as it may deform the products. 2. Stress may be applied to a product with a warp or a twist in handling of the product. Please conduct validation completely before studying adoption of this product and please judge the pros and cons of adoption of this product with taking on responsibility. (LSXN/LSXP/LLXN/LLXP) <div style="display: flex; justify-content: space-around; align-items: center;"> <div style="text-align: center;"> <p><Wrap></p> </div> <div style="text-align: center;"> <p><Twist></p> </div> </div>

4. Soldering

Precautions	<ul style="list-style-type: none"> ◆ Reflow soldering 1. Please contact any of our offices for a reflow soldering, and refer to the recommended condition specified. 2. The product shall be used reflow soldering only. 3. Please do not add any stress to a product until it returns in normal temperature after reflow soldering. ◆ Lead free soldering 1. When using products with lead free soldering, we request to use them after confirming adhesion, temperature of resistance to soldering heat, soldering etc sufficiently. ◆ Recommended conditions for using a soldering iron (Repair) <ul style="list-style-type: none"> • Put the soldering iron on the land-pattern. • Soldering iron's temperature - Below 350°C • Duration - 3 seconds or less • The soldering iron should not directly touch the inductor.
Technical considerations	<ul style="list-style-type: none"> ◆ Reflow soldering 1. If products are used beyond the range of the recommended conditions, heat stresses may deform the products, and consequently degrade the reliability of the products. <p style="text-align: center;">Recommended reflow condition (Pb free solder)</p>

5. Cleaning

Precautions	<ul style="list-style-type: none"> ◆ Cleaning conditions 1. Washing by supersonic waves shall be avoided.
Technical considerations	<ul style="list-style-type: none"> ◆ Cleaning conditions 1. If washed by supersonic waves, the products might be broken.

▶ This catalog contains the typical specification only due to the limitation of space. When you consider the purchase of our products, please check our specification. For details of each product (characteristics graph, reliability information, precautions for use, and so on), see our Web site (<http://www.ty-top.com/>)

6. Handling

Precautions	<ul style="list-style-type: none"> ◆ Handling <ol style="list-style-type: none"> 1. Keep the product away from all magnets and magnetic objects. ◆ Breakaway PC boards (splitting along perforations) <ol style="list-style-type: none"> 1. When splitting the PC board after mounting product, care should be taken not to give any stresses of deflection or twisting to the board. 2. Board separation should not be done manually, but by using the appropriate devices. ◆ Mechanical considerations <ol style="list-style-type: none"> 1. Please do not give the product any excessive mechanical shocks. 2. Please do not add any shock and power to a product in transportation. ◆ Pick-up pressure <ol style="list-style-type: none"> 1. Please do not push to add any pressure to a winding part. Please do not give any shock and push into a ferrite core exposure part. ◆ Packing <ol style="list-style-type: none"> 1. Please avoid accumulation of a packing box as much as possible.
Technical considerations	<ul style="list-style-type: none"> ◆ Handling <ol style="list-style-type: none"> 1. There is a case that a characteristic varies with magnetic influence. ◆ Breakaway PC boards (splitting along perforations) <ol style="list-style-type: none"> 1. The position of the product on PCBs shall be carefully considered to minimize the stress caused from splitting of the PCBs. ◆ Mechanical considerations <ol style="list-style-type: none"> 1. There is a case to be damaged by a mechanical shock. 2. There is a case to be broken by the handling in transportation. ◆ Pick-up pressure <ol style="list-style-type: none"> 1. Damage and a characteristic can vary with an excessive shock or stress. ◆ Packing <ol style="list-style-type: none"> 1. If packing boxes are accumulated, that could cause a deformation on packing tapes or a damage on the products.

7. Storage conditions

Precautions	<ul style="list-style-type: none"> ◆ Storage <ol style="list-style-type: none"> 1. To maintain the solderability of terminal electrodes and to keep the packing material in good condition, temperature and humidity in the storage area should be controlled. <ul style="list-style-type: none"> ▪ Storage conditions <ul style="list-style-type: none"> Ambient temperature : $-5\sim 40^{\circ}\text{C}$ Humidity : Below 70% RH ▪ The recommended ambient temperature is below 30°C. Even under ideal storage conditions, solderability of products electrodes may decrease as time passes. <p style="margin-left: 40px;">For this reason, product should be used within 6 months from the time of delivery.</p> <p style="margin-left: 40px;">In case of storage over 6 months, solderability shall be checked before actual usage.</p>
Technical considerations	<ul style="list-style-type: none"> ◆ Storage <ol style="list-style-type: none"> 1. Under a high temperature and humidity environment, problems such as reduced solderability caused by oxidation of terminal electrodes and deterioration of taping/packaging materials may take place.

医疗设备（国际（GHTF）第一类、第二类）用途 绕线型铁氧体系功率电感器 LLQP系列

系列前的记号来自型号，用来区分产品的种类和特性等。

回流焊

■ 型号标示法

*使用温度范围：-40~+105℃（包含产品本身发热）

L	L	Q	P	B	2	5	1	8	1	2	T	2	R	2	M	
①	②	③	④	⑤	⑥	⑦	⑧									

①系列

代码 (1)(2)(3)(4)	
LLQP	医疗设备（国际（GHTF）第一类、第二类）用途 绕线型铁氧体系功率电感器

(1) 产品群

代码	
L	电感器

(3) 类型

代码	
Q	绕线型铁氧体系 横型

(2) 范畴

代码	推荐设备	品质等级
L	医疗设备（国际（GHTF）第一类、第二类）	3

(4) 特效 / 特性

代码	
P	大电流功率扼流

②特征

代码	特征
B	L字电极（树脂银×镀锡）

⑤包装

代码	包装
T	卷盘带装

③尺寸（L×W）

代码	外型 (inch)	尺寸 (L×W) [mm]
1608	1608 (0603)	1.6×0.8
2012	2012 (0805)	2.0×1.25
2016	2016 (0806)	2.0×1.6
2518	2518 (1007)	2.5×1.8
3225	3225 (1210)	3.2×2.5

⑥标称电感值

代码 (例)	标称电感值 [μH]
R20	0.2
1R0	1.0
100	10
101	100

※R=小数点

④尺寸（T）

代码	尺寸 (T) [mm]
07	0.7
08	0.8
10	1.0
12	1.2
14	1.4
15	1.5
16	1.6
17	1.7
18	1.8

⑦电感量公差

代码	电感量公差
K	±10%
M	±20%

⑧管理记号

▶ 由于篇幅有限，本产品目录中只记载了有代表性的产品规格，若考虑使用敝公司产品时，请确认交货规格说明书中的详细规格。
另外，有关各产品的详细信息（特性图、可靠性信息、使用时的注意事项等），请参阅敝公司网站（<http://www.ty-top.com/>）。

■标准外型尺寸 / 标准数量

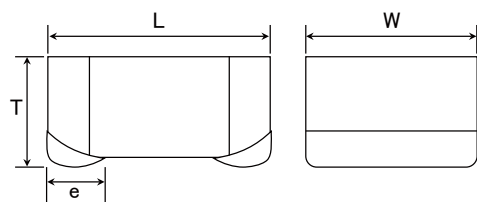

推荐焊盘图案

实装上的注意

- 请确认实装状态后使用。
- 本产品焊法限定为回流焊法。



Type	A	B	C
1608	0.55	0.70	1.00
2012	0.60	1.00	1.45
2016	0.60	1.00	1.80
2518	0.60	1.50	2.00
3225	0.85	1.70	2.70

单位: mm

Type	L	W	T	e	标准数量 [pcs]	
					纸带	压模带
160807	1.6±0.2 (0.063±0.008)	0.8±0.2 (0.031±0.008)	0.7 max (0.028 max)	0.45±0.15 (0.016±0.006)	—	3000
160808	1.6±0.2 (0.063±0.008)	0.8±0.2 (0.031±0.008)	0.8±0.2 (0.031±0.008)	0.45±0.15 (0.016±0.006)	—	3000
201210	2.0±0.2 (0.079±0.008)	1.25±0.2 (0.049±0.008)	1.0 max (0.040 max)	0.5±0.2 (0.020±0.008)	—	3000
201214	2.0±0.2 (0.079±0.008)	1.25±0.2 (0.049±0.008)	1.4 max (0.056 max)	0.5±0.2 (0.020±0.008)	—	2000
201616	2.0±0.2 (0.079±0.008)	1.6±0.2 (0.063±0.008)	1.6±0.2 (0.063±0.008)	0.5±0.2 (0.020±0.008)	—	2000
251810	2.5±0.2 (0.098±0.008)	1.8±0.2 (0.071±0.008)	1.0 max (0.040 max)	0.5±0.2 (0.020±0.008)	—	3000
251812	2.5±0.2 (0.098±0.008)	1.8±0.2 (0.071±0.008)	1.2 max (0.048 max)	0.5±0.2 (0.020±0.008)	—	3000
251815	2.5±0.2 (0.098±0.008)	1.8±0.2 (0.071±0.008)	1.5 max (0.060 max)	0.5±0.2 (0.020±0.008)	—	2000
251818	2.5±0.2 (0.098±0.008)	1.8±0.2 (0.071±0.008)	1.8±0.2 (0.071±0.008)	0.5±0.2 (0.020±0.008)	—	2000
322517	3.2±0.2 (0.126±0.008)	2.5±0.2 (0.098±0.008)	1.7 max (0.068 max)	0.75±0.2 (0.03±0.008)	—	2000

单位: mm (inch)

PART NUMBER

● 1608 (0603) type

New part number	Old part number (for reference)	EHS	Nominal inductance [μ H]	Inductance tolerance	Self-resonant frequency [MHz] (min.)	DC Resistance [Ω] ($\pm 30\%$)	Rated current ※) [mA]		Measuring frequency [MHz]
							Saturation current Idc1	Temperature rise current Idc2	
LLQPB160807T1R0M	BR L1608T1R0M	RoHS	1.0	$\pm 20\%$	700	0.230	510	650	1.0
LLQPB160807T1R5M	BR L1608T1R5M	RoHS	1.5	$\pm 20\%$	600	0.280	440	590	1.0
LLQPB160807T2R2M	BR L1608T2R2M	RoHS	2.2	$\pm 20\%$	400	0.400	360	500	1.0
LLQPB160807T3R3M	BR L1608T3R3M	RoHS	3.3	$\pm 20\%$	300	0.650	290	390	1.0
LLQPB160807T4R7M	BR L1608T4R7M	RoHS	4.7	$\pm 20\%$	150	1.00	240	310	1.0
LLQPB160807T6R8M	BR L1608T6R8M	RoHS	6.8	$\pm 20\%$	100	1.64	200	250	1.0
LLQPB160807T100M	BR L1608T100M	RoHS	10	$\pm 20\%$	45	2.00	170	220	1.0
LLQPB160807T150M	BR L1608T150M	RoHS	15	$\pm 20\%$	32	2.56	150	200	1.0

New part number	Old part number (for reference)	EHS	Nominal inductance [μ H]	Inductance tolerance	Self-resonant frequency [MHz] (min.)	DC Resistance [Ω] ($\pm 30\%$)	Rated current ※) [mA]		Measuring frequency [MHz]
							Saturation current Idc1	Temperature rise current Idc2	
LLQPB160808TR43M06	BR C1608TR43M 6	RoHS	0.43	$\pm 20\%$	740	0.082	1,400	1,100	6.0
LLQPB160808TR50M06	BR C1608TR50M 6	RoHS	0.50	$\pm 20\%$	710	0.090	1,200	1,050	6.0
LLQPB160808TR60M06	BR C1608TR60M 6	RoHS	0.60	$\pm 20\%$	630	0.099	1,100	940	6.0
LLQPB160808TR72M06	BR C1608TR72M 6	RoHS	0.72	$\pm 20\%$	600	0.144	1,000	810	6.0
LLQPB160808TR82M06	BR C1608TR82M 6	RoHS	0.82	$\pm 20\%$	560	0.176	950	730	6.0
LLQPB160808T1R0M06	BR C1608T1R0M 6	RoHS	1.0	$\pm 20\%$	550	0.188	890	680	6.0

New part number	Old part number (for reference)	EHS	Nominal inductance [μ H]	Inductance tolerance	Self-resonant frequency [MHz] (min.)	DC Resistance [Ω] ($\pm 30\%$)	Rated current ※) [mA]		Measuring frequency [MHz]
							Saturation current Idc1	Temperature rise current Idc2	
LLQPB160808TR20M	BR C1608TR20M	RoHS	0.20	$\pm 20\%$	400	0.060	1,750	980	7.96
LLQPB160808TR35M	BR C1608TR35M	RoHS	0.35	$\pm 20\%$	300	0.080	1,400	810	7.96
LLQPB160808TR45M	BR C1608TR45M	RoHS	0.45	$\pm 20\%$	200	0.090	1,250	800	7.96
LLQPB160808TR56M	BR C1608TR56M	RoHS	0.56	$\pm 20\%$	170	0.095	1,150	760	7.96
LLQPB160808TR77M	BR C1608TR77M	RoHS	0.77	$\pm 20\%$	150	0.110	1,000	660	7.96
LLQPB160808T1R0M	BR C1608T1R0M	RoHS	1.0	$\pm 20\%$	140	0.180	850	520	7.96
LLQPB160808T1R5M	BR C1608T1R5M	RoHS	1.5	$\pm 20\%$	120	0.300	700	410	7.96
LLQPB160808T2R2M	BR C1608T2R2M	RoHS	2.2	$\pm 20\%$	100	0.550	550	280	7.96

● 2012 (0805) type

New part number	Old part number (for reference)	EHS	Nominal inductance [μ H]	Inductance tolerance	Self-resonant frequency [MHz] (min.)	DC Resistance [Ω] ($\pm 30\%$)	Rated current ※) [mA]		Measuring frequency [MHz]
							Saturation current Idc1	Temperature rise current Idc2	
LLQPB201210TR47M06	BR L2012TR47M 6	RoHS	0.47	$\pm 20\%$	500	0.048	1,500	1,900	6.0
LLQPB201210T1R0M06	BR L2012T1R0M 6	RoHS	1.0	$\pm 20\%$	400	0.108	1,050	1,230	6.0
LLQPB201210T2R2MD6	BR L2012T2R2MD6	RoHS	2.2	$\pm 20\%$	250	0.184	680	950	6.0

New part number	Old part number (for reference)	EHS	Nominal inductance [μ H]	Inductance tolerance	Self-resonant frequency [MHz] (min.)	DC Resistance [Ω] ($\pm 30\%$)	Rated current ※) [mA]		Measuring frequency [MHz]
							Saturation current Idc1	Temperature rise current Idc2	
LLQPB201210TR47M	BR L2012TR47M	RoHS	0.47	$\pm 20\%$	350	0.090	1,100	1,050	7.96
LLQPB201210T1R0M	BR L2012T1R0M	RoHS	1.0	$\pm 20\%$	300	0.135	850	850	7.96
LLQPB201210T1R5M	BR L2012T1R5M	RoHS	1.5	$\pm 20\%$	250	0.180	700	750	7.96
LLQPB201210T2R2M	BR L2012T2R2M	RoHS	2.2	$\pm 20\%$	200	0.300	600	550	7.96
LLQPB201210T3R3M	BR L2012T3R3M	RoHS	3.3	$\pm 20\%$	190	0.500	490	440	7.96
LLQPB201210T4R7M	BR L2012T4R7M	RoHS	4.7	$\pm 20\%$	150	0.550	340	400	7.96
LLQPB201210T6R8M	BR L2012T6R8M	RoHS	6.8	$\pm 20\%$	60	0.750	290	350	7.96
LLQPB201210T100M	BR L2012T100M	RoHS	10	$\pm 20\%$	30	0.850	270	330	2.52
LLQPB201210T150M	BR L2012T150M	RoHS	15	$\pm 20\%$	15	1.00	220	300	2.52
LLQPB201210T220M	BR L2012T220M	RoHS	22	$\pm 20\%$	13	1.30	190	270	2.52
LLQPB201210T330M	BR L2012T330M	RoHS	33	$\pm 20\%$	8.0	2.00	150	220	2.52
LLQPB201210T470M	BR L2012T470M	RoHS	47	$\pm 20\%$	7.0	3.50	125	160	2.52
LLQPB201210T680M	BR L2012T680M	RoHS	68	$\pm 20\%$	6.5	5.80	100	110	2.52
LLQPB201210T101M	BR L2012T101M	RoHS	100	$\pm 20\%$	6.0	7.70	85	85	0.796

New part number	Old part number (for reference)	EHS	Nominal inductance [μ H]	Inductance tolerance	Self-resonant frequency [MHz] (min.)	DC Resistance [Ω] ($\pm 30\%$)	Rated current ※) [mA]		Measuring frequency [MHz]
							Saturation current Idc1	Temperature rise current Idc2	
LLQPB201214T1R0M	BR C2012T1R0M	RoHS	1.0	$\pm 20\%$	490	0.060	1,500	1,400	1.0
LLQPB201214T1R5MD	BR C2012T1R5MD	RoHS	1.5	$\pm 20\%$	390	0.090	1,200	1,100	1.0
LLQPB201214T2R2MD	BR C2012T2R2MD	RoHS	2.2	$\pm 20\%$	350	0.110	1,100	1,000	1.0
LLQPB201214T3R3MD	BR C2012T3R3MD	RoHS	3.3	$\pm 20\%$	300	0.170	800	870	1.0
LLQPB201214T4R7MD	BR C2012T4R7MD	RoHS	4.7	$\pm 20\%$	250	0.265	700	600	1.0

※) The saturation current value (Idc1) is the DC current value having inductance decrease down to 30%. (at 20°C)

※) The temperature rise current value (Idc2) is the DC current value having temperature increase by 40°C. (at 20°C)

※) The rated current value is following either Idc1 or Idc2, which is the lower one.

■ PART NUMBER

● 2016 (0806) type

New part number	Old part number (for reference)	EHS	Nominal inductance [μ H]	Inductance tolerance	Self-resonant frequency [MHz] (min.)	DC Resistance [Ω] ($\pm 30\%$)	Rated current ※) [mA]		Measuring frequency [MHz]
							Saturation current Idc1	Temperature rise current Idc2	
LLQPB201616T1R0M	BR C2016T1R0M	RoHS	1.0	$\pm 20\%$	450	0.085	1,350	1,100	0.10
LLQPB201616T1R5M	BR C2016T1R5M	RoHS	1.5	$\pm 20\%$	370	0.150	1,100	820	0.10
LLQPB201616T2R2M	BR C2016T2R2M	RoHS	2.2	$\pm 20\%$	250	0.180	910	760	0.10
LLQPB201616T3R3M	BR C2016T3R3M	RoHS	3.3	$\pm 20\%$	140	0.220	740	680	0.10
LLQPB201616T4R7M	BR C2016T4R7M	RoHS	4.7	$\pm 20\%$	78	0.270	660	610	0.10
LLQPB201616T6R8M	BR C2016T6R8M	RoHS	6.8	$\pm 20\%$	39	0.330	550	560	0.10
LLQPB201616T100K	BR C2016T100K	RoHS	10	$\pm 10\%$	35	0.400	450	520	0.10
LLQPB201616T100M	BR C2016T100M	RoHS	10	$\pm 20\%$	35	0.400	450	520	0.10
LLQPB201616T150K	BR C2016T150K	RoHS	15	$\pm 10\%$	28	0.600	400	410	0.10
LLQPB201616T150M	BR C2016T150M	RoHS	15	$\pm 20\%$	28	0.600	400	410	0.10
LLQPB201616T220K	BR C2016T220K	RoHS	22	$\pm 10\%$	24	1.00	310	310	0.10
LLQPB201616T220M	BR C2016T220M	RoHS	22	$\pm 20\%$	24	1.00	310	310	0.10
LLQPB201616T330K	BR C2016T330K	RoHS	33	$\pm 10\%$	13	1.70	270	240	0.10
LLQPB201616T330M	BR C2016T330M	RoHS	33	$\pm 20\%$	13	1.70	270	240	0.10
LLQPB201616T470K	BR C2016T470K	RoHS	47	$\pm 10\%$	11	2.20	210	210	0.10
LLQPB201616T470M	BR C2016T470M	RoHS	47	$\pm 20\%$	11	2.20	210	210	0.10
LLQPB201616T680K	BR C2016T680K	RoHS	68	$\pm 10\%$	8	2.80	200	190	0.10
LLQPB201616T680M	BR C2016T680M	RoHS	68	$\pm 20\%$	8	2.80	200	190	0.10
LLQPB201616T101K	BR C2016T101K	RoHS	100	$\pm 10\%$	7	3.40	140	170	0.10
LLQPB201616T101M	BR C2016T101M	RoHS	100	$\pm 20\%$	7	3.40	140	170	0.10

● 2518 (1007) type

New part number	Old part number (for reference)	EHS	Nominal inductance [μ H]	Inductance tolerance	Self-resonant frequency [MHz] (min.)	DC Resistance [Ω] ($\pm 30\%$)	Rated current ※) [mA]		Measuring frequency [MHz]
							Saturation current Idc1	Temperature rise current Idc2	
LLQPB251810T1R0M	BRFL2518T1R0M	RoHS	1.0	$\pm 20\%$	130	0.090	1,200	1,200	1.0
LLQPB251810T1R5M	BRFL2518T1R5M	RoHS	1.5	$\pm 20\%$	100	0.110	1,100	1,000	1.0
LLQPB251810T2R2M	BRFL2518T2R2M	RoHS	2.2	$\pm 20\%$	80	0.130	850	950	1.0
LLQPB251810T3R3M	BRFL2518T3R3M	RoHS	3.3	$\pm 20\%$	70	0.220	700	700	1.0
LLQPB251810T4R7M	BRFL2518T4R7M	RoHS	4.7	$\pm 20\%$	60	0.330	650	650	1.0

New part number	Old part number (for reference)	EHS	Nominal inductance [μ H]	Inductance tolerance	Self-resonant frequency [MHz] (min.)	DC Resistance [Ω] ($\pm 30\%$)	Rated current ※) [mA]		Measuring frequency [MHz]
							Saturation current Idc1	Temperature rise current Idc2	
LLQPB251812T1R0M	BR L2518T1R0M	RoHS	1.0	$\pm 20\%$	130	0.080	1,600	1,000	7.96
LLQPB251812T1R5M	BR L2518T1R5M	RoHS	1.5	$\pm 20\%$	100	0.100	1,200	920	7.96
LLQPB251812T2R2M	BR L2518T2R2M	RoHS	2.2	$\pm 20\%$	80	0.135	1,000	850	7.96
LLQPB251812T3R3M	BR L2518T3R3M	RoHS	3.3	$\pm 20\%$	70	0.300	800	580	7.96
LLQPB251812T4R7M	BR L2518T4R7M	RoHS	4.7	$\pm 20\%$	60	0.400	700	470	7.96

New part number	Old part number (for reference)	EHS	Nominal inductance [μ H]	Inductance tolerance	Self-resonant frequency [MHz] (min.)	DC Resistance [Ω] ($\pm 30\%$)	Rated current ※) [mA]		Measuring frequency [MHz]
							Saturation current Idc1	Temperature rise current Idc2	
LLQPB251815T1R0M	BRHL2518T1R0M	RoHS	1.0	$\pm 20\%$	400	0.055	2,000	1,400	1.0
LLQPB251815T1R5M	BRHL2518T1R5M	RoHS	1.5	$\pm 20\%$	350	0.085	1,700	1,100	1.0
LLQPB251815T2R2M	BRHL2518T2R2M	RoHS	2.2	$\pm 20\%$	300	0.115	1,500	1,000	1.0
LLQPB251815T3R3MD	BRHL2518T3R3MD	RoHS	3.3	$\pm 20\%$	200	0.165	1,200	800	1.0
LLQPB251815T4R7MD	BRHL2518T4R7MD	RoHS	4.7	$\pm 20\%$	150	0.245	1,100	750	1.0

New part number	Old part number (for reference)	EHS	Nominal inductance [μ H]	Inductance tolerance	Self-resonant frequency [MHz] (min.)	DC Resistance [Ω] ($\pm 30\%$)	Rated current ※) [mA]		Measuring frequency [MHz]
							Saturation current Idc1	Temperature rise current Idc2	
LLQPB251818T1R0M	BR C2518T1R0M	RoHS	1.0	$\pm 20\%$	280	0.050	2,550	1,650	1.0
LLQPB251818T1R5M	BR C2518T1R5M	RoHS	1.5	$\pm 20\%$	230	0.080	2,100	1,300	1.0
LLQPB251818T2R2M	BR C2518T2R2M	RoHS	2.2	$\pm 20\%$	200	0.120	1,800	1,000	1.0
LLQPB251818T3R3M	BR C2518T3R3M	RoHS	3.3	$\pm 20\%$	150	0.175	1,450	860	1.0
LLQPB251818T4R7M	BR C2518T4R7M	RoHS	4.7	$\pm 20\%$	100	0.230	1,250	750	1.0
LLQPB251818T6R8M	BR C2518T6R8M	RoHS	6.8	$\pm 20\%$	45	0.280	1,050	680	1.0
LLQPB251818T100K	BR C2518T100K	RoHS	10	$\pm 10\%$	20	0.350	890	610	1.0
LLQPB251818T100M	BR C2518T100M	RoHS	10	$\pm 20\%$	20	0.350	890	610	1.0
LLQPB251818T150K	BR C2518T150K	RoHS	15	$\pm 10\%$	13	0.430	760	550	1.0
LLQPB251818T150M	BR C2518T150M	RoHS	15	$\pm 20\%$	13	0.430	760	550	1.0
LLQPB251818T220K	BR C2518T220K	RoHS	22	$\pm 10\%$	10	0.560	640	490	1.0
LLQPB251818T220M	BR C2518T220M	RoHS	22	$\pm 20\%$	10	0.560	640	490	1.0
LLQPB251818T330K	BR C2518T330K	RoHS	33	$\pm 10\%$	8	0.850	560	390	1.0
LLQPB251818T330M	BR C2518T330M	RoHS	33	$\pm 20\%$	8	0.850	560	390	1.0
LLQPB251818T470K	BR C2518T470K	RoHS	47	$\pm 10\%$	6.5	1.45	410	300	1.0
LLQPB251818T470M	BR C2518T470M	RoHS	47	$\pm 20\%$	6.5	1.45	410	300	1.0
LLQPB251818T680K	BR C2518T680K	RoHS	68	$\pm 10\%$	5.5	2.40	340	230	1.0
LLQPB251818T680M	BR C2518T680M	RoHS	68	$\pm 20\%$	5.5	2.40	340	230	1.0
LLQPB251818T101K	BR C2518T101K	RoHS	100	$\pm 10\%$	4.5	3.60	300	190	1.0
LLQPB251818T101M	BR C2518T101M	RoHS	100	$\pm 20\%$	4.5	3.60	300	190	1.0

※) The saturation current value (Idc1) is the DC current value having inductance decrease down to 30%. (at 20°C)

※) The temperature rise current value (Idc2) is the DC current value having temperature increase by 40°C. (at 20°C)

※) The rated current value is following either Idc1 or Idc2, which is the lower one.

PART NUMBER

3225(1210) type

New part number	Old part number (for reference)	EHS	Nominal inductance [μ H]	Inductance tolerance	Self-resonant frequency [MHz] (min.)	DC Resistance [Ω] ($\pm 30\%$)	Rated current ※) [mA]		Measuring frequency [MHz]
							Saturation current Idc1	Temperature rise current Idc2	
LLQPB322517TR27M	BR L3225TR27M	RoHS	0.27	$\pm 20\%$	390	0.022	4,500	2,850	7.96
LLQPB322517TR36M	BR L3225TR36M	RoHS	0.36	$\pm 20\%$	350	0.025	4,300	2,750	7.96
LLQPB322517TR51M	BR L3225TR51M	RoHS	0.51	$\pm 20\%$	270	0.029	3,600	2,550	7.96

New part number	Old part number (for reference)	EHS	Nominal inductance [μ H]	Inductance tolerance	Self-resonant frequency [MHz] (min.)	DC Resistance [Ω] ($\pm 20\%$)	Rated current ※) [mA]		Measuring frequency [MHz]
							Saturation current Idc1	Temperature rise current Idc2	
LLQPB322517T1R0M	BR L3225T1R0M	RoHS	1.0	$\pm 20\%$	220	0.043	2,400	2,200	0.1
LLQPB322517T1R5M	BR L3225T1R5M	RoHS	1.5	$\pm 20\%$	170	0.045	2,200	1,750	0.1
LLQPB322517T2R2M	BR L3225T2R2M	RoHS	2.2	$\pm 20\%$	150	0.065	1,850	1,600	0.1
LLQPB322517T3R3M	BR L3225T3R3M	RoHS	3.3	$\pm 20\%$	140	0.120	1,450	1,200	0.1
LLQPB322517T4R7M	BR L3225T4R7M	RoHS	4.7	$\pm 20\%$	120	0.180	1,300	1,000	0.1
LLQPB322517T6R8M	BR L3225T6R8M	RoHS	6.8	$\pm 20\%$	90	0.270	1,050	770	0.1
LLQPB322517T100K	BR L3225T100K	RoHS	10	$\pm 10\%$	70	0.350	900	700	0.1
LLQPB322517T100M	BR L3225T100M	RoHS	10	$\pm 20\%$	70	0.350	900	700	0.1
LLQPB322517T150K	BR L3225T150K	RoHS	15	$\pm 10\%$	20	0.570	700	530	0.1
LLQPB322517T150M	BR L3225T150M	RoHS	15	$\pm 20\%$	20	0.570	700	530	0.1
LLQPB322517T220K	BR L3225T220K	RoHS	22	$\pm 10\%$	13	0.690	550	470	0.1
LLQPB322517T220M	BR L3225T220M	RoHS	22	$\pm 20\%$	13	0.690	550	470	0.1
LLQPB322517T330K	BR L3225T330K	RoHS	33	$\pm 10\%$	9	0.840	470	420	0.1
LLQPB322517T330M	BR L3225T330M	RoHS	33	$\pm 20\%$	9	0.840	470	420	0.1
LLQPB322517T470K	BR L3225T470K	RoHS	47	$\pm 10\%$	7	1.00	420	390	0.1
LLQPB322517T470M	BR L3225T470M	RoHS	47	$\pm 20\%$	7	1.00	420	390	0.1
LLQPB322517T680K	BR L3225T680K	RoHS	68	$\pm 10\%$	6	1.40	330	300	0.1
LLQPB322517T680M	BR L3225T680M	RoHS	68	$\pm 20\%$	6	1.40	330	300	0.1
LLQPB322517T101K	BR L3225T101K	RoHS	100	$\pm 10\%$	5	2.50	270	250	0.1
LLQPB322517T101M	BR L3225T101M	RoHS	100	$\pm 20\%$	5	2.50	270	250	0.1

※) The saturation current value (Idc1) is the DC current value having inductance decrease down to 30%. (at 20°C)

※) The temperature rise current value (Idc2) is the DC current value having temperature increase by 40°C. (at 20°C)

※) The rated current value is following either Idc1 or Idc2, which is the lower one.

Wire-wound Ferrite Power Inductors LSQPB/LLQPB series

PACKAGING

① Minimum Quantity

Type	Standard Quantity [pcs]	
	Paper Tape	Embossed Tape
160807	—	3,000
160808	—	3,000
201210	—	3,000
201214	—	2,000
201616	—	2,000
251810	—	3,000
251812	—	3,000
251815	—	2,000
251818	—	2,000
322517	—	2,000

② Tape Material

● Embossed tape

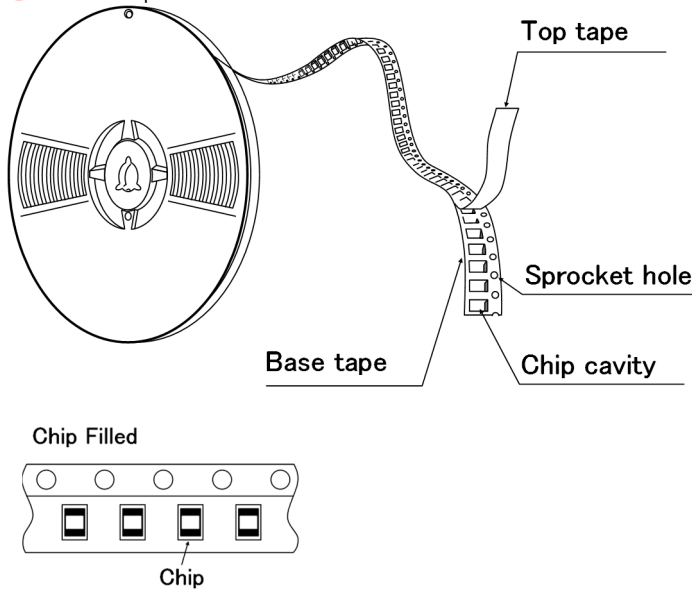

③ Taping dimensions

● Embossed Tape 8mm wide (0.315 inches wide)

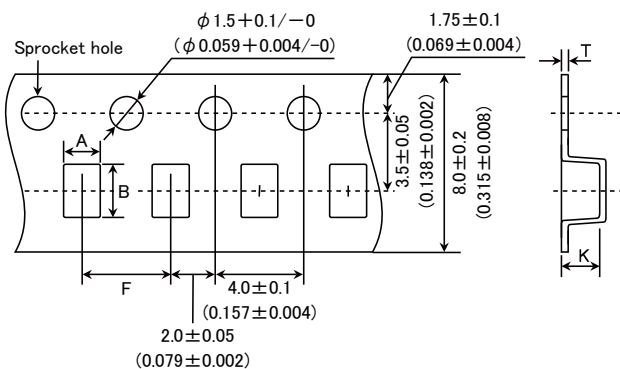

► This catalog contains the typical specification only due to the limitation of space. When you consider the purchase of our products, please check our specification. For details of each product (characteristics graph, reliability information, precautions for use, and so on), see our Web site (<http://www.ty-top.com/>).

Type	Chip cavity		Insertion pitch	Tape thickness	
	A	B		T	K
160807	1.1±0.1 (0.043±0.004)	1.9±0.1 (0.075±0.004)	4.0±0.1 (0.157±0.004)	0.2±0.05 (0.008±0.002)	0.9 max (0.035 max)
160808	1.1±0.1 (0.043±0.004)	1.9±0.1 (0.075±0.004)	4.0±0.1 (0.157±0.004)	0.25±0.05 (0.010±0.002)	1.2 max (0.047 max)
201210	1.45±0.1 (0.057±0.004)	2.2±0.1 (0.087±0.004)	4.0±0.1 (0.157±0.004)	0.25±0.05 (0.010±0.002)	1.2 max (0.047 max)
201214	1.45±0.1 (0.057±0.004)	2.37±0.1 (0.093±0.004)	4.0±0.1 (0.157±0.004)	0.25±0.05 (0.010±0.002)	1.59 max (0.063 max)
201616	1.75±0.1 (0.069±0.004)	2.1±0.1 (0.083±0.004)	4.0±0.1 (0.157±0.004)	0.3±0.05 (0.012±0.002)	1.9 max (0.075 max)
251810	2.3±0.1 (0.091±0.004)	2.8±0.1 (0.110±0.004)	4.0±0.1 (0.157±0.004)	0.25±0.05 (0.010±0.002)	1.3 max (0.051 max)
251812	2.3±0.1 (0.091±0.004)	2.8±0.1 (0.110±0.004)	4.0±0.1 (0.157±0.004)	0.3±0.05 (0.012±0.002)	1.45 max (0.057 max)
251815	2.1±0.1 (0.083±0.004)	2.8±0.1 (0.110±0.004)	4.0±0.1 (0.157±0.004)	0.3±0.05 (0.012±0.002)	1.7 max (0.067 max)
251818	2.15±0.1 (0.085±0.004)	2.7±0.1 (0.106±0.004)	4.0±0.1 (0.157±0.004)	0.3±0.05 (0.012±0.002)	2.2 max (0.087 max)
322517	2.8±0.1 (0.110±0.004)	3.5±0.1 (0.138±0.004)	4.0±0.1 (0.157±0.004)	0.25±0.05 (0.010±0.002)	1.9 max (0.075 max)

Unit: mm (inch)

④ Leader and Blank portion

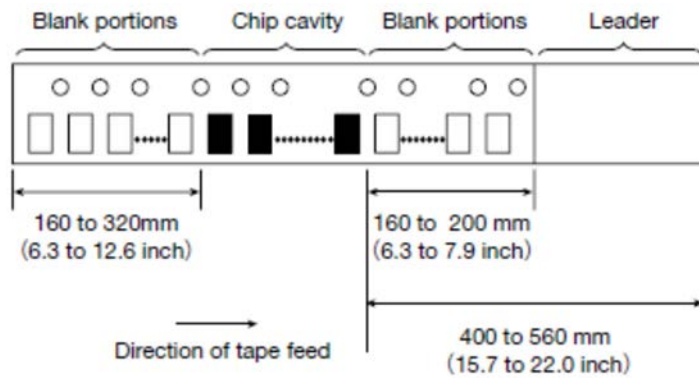

⑤ Reel size

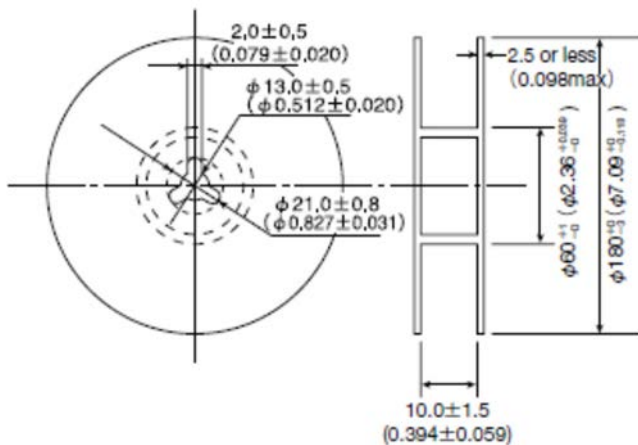

⑥ Top Tape Strength

The top tape requires a peel-off force of 0.1 to 1.0N in the direction of the arrow as illustrated below.

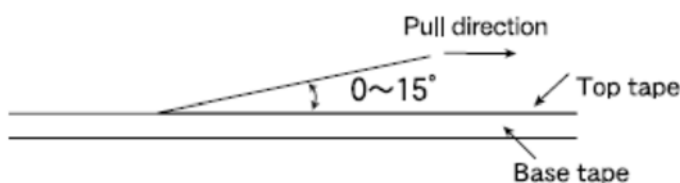

Wire-wound Ferrite Power Inductors LSQPB series for General Electronic Equipment for Consumer
Wire-wound Ferrite Power Inductors LLQPB series
for Medical Devices classified as GHTF Classes A or B (Japan Classes I or II)

■ RELIABILITY DATA

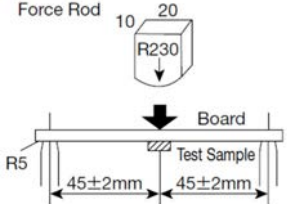
1. Operating Temperature Range	
Specified Value	-40~+105°C
Test Methods and Remarks	Including self-generated heat
2. Storage Temperature Range (after soldering)	
Specified Value	-40~+85°C
Test Methods and Remarks	Please refer the term of "7.Storage conditions" in Precautions.
3. Rated current	
Specified Value	Within the specified tolerance
4. Inductance	
Specified Value	Within the specified tolerance
Test Methods and Remarks	Measuring equipment : LCR Meter (HP 4285A or equivalent) Measuring frequency : Specified frequency
5. DC Resistance	
Specified Value	Within the specified tolerance
Test Methods and Remarks	Measuring equipment : DC ohmmeter (HIOKI 3227 or equivalent)
6. Self resonance frequency	
Specified Value	Within the specified tolerance
Test Methods and Remarks	Measuring equipment : Impedance analyzer/material analyzer (HP4291A or equivalent HP4191A, 4192A or equivalent)
7. Temperature characteristic	
Specified Value	Inductance change : Within $\pm 15\%$
Test Methods and Remarks	Based on the inductance at 20°C and Measured at the ambient of -40°C~+85°C.
8. Resistance to the bendability	
Specified Value	No damage.
Test Methods and Remarks	The given sample is soldered on the board and then the back side of the board is pushed until it bends 2mm like the figure. Dimension of the board : 100×40×1.0mm (0.8mm thickness for 1608(0603) inductors) Material of the board : Glass epoxy-resin Thickness of soldering paste : 0.12mm 

▶ This catalog contains the typical specification only due to the limitation of space. When you consider the purchase of our products, please check our specification.
 For details of each product (characteristics graph, reliability information, precautions for use, and so on), see our Web site (<http://www.ty-top.com/>).

9. Body strength

Specified Value	No damage.
Test Methods and Remarks	2012~ Applied orce : 10N Duration : 10sec. 1608 size Applied force : 5N Duration : 10sec.

10. Adhesion of terminal electrodes

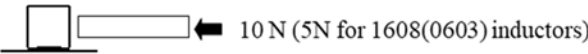
Specified Value	Not to removed from the board.
Test Methods and Remarks	The given sample is soldered to the board and then it is kept for 5sec with 10N stress (5N for 1608(0603) inductors) like the figure. 

11. Resistance to vibration

Specified Value	Inductance change : Within $\pm 10\%$ No significant abnormality in appearance.										
Test Methods and Remarks	The given sample is soldered to the board and then it is tested depending on the conditions of the following table. <table border="1" data-bbox="295 757 1168 929"> <tr> <td>Vibration Frequency</td> <td>10~55Hz</td> </tr> <tr> <td>Total Amplitude</td> <td>1.5mm (May not exceed acceleration 196m/s²)</td> </tr> <tr> <td>Sweeping Method</td> <td>10Hz to 55Hz to 10Hz for 1min.</td> </tr> <tr> <td rowspan="3">Time</td> <td>X</td> </tr> <tr> <td>Y</td> </tr> <tr> <td>Z</td> </tr> </table> <p style="text-align: center;">For 2 hours on each X, Y, and Z axis.</p> Recovery : At least 2hrs of recovery under the standard condition after the test, followed by the measurement within 48hrs.	Vibration Frequency	10~55Hz	Total Amplitude	1.5mm (May not exceed acceleration 196m/s ²)	Sweeping Method	10Hz to 55Hz to 10Hz for 1min.	Time	X	Y	Z
Vibration Frequency	10~55Hz										
Total Amplitude	1.5mm (May not exceed acceleration 196m/s ²)										
Sweeping Method	10Hz to 55Hz to 10Hz for 1min.										
Time	X										
	Y										
	Z										

12. Solderability

Specified Value	At least 90% area of the electrodes is covered by new solder.				
Test Methods and Remarks	Test Method and Remarks】 The given sample is dipped into the flux and then it is tested depending on the conditions of the following table. Flux : Ethanol solution containing rosin 25%. <table border="1" data-bbox="295 1160 715 1220"> <tr> <td>Solder Temperature</td> <td>245\pm5$^{\circ}$C</td> </tr> <tr> <td>Time</td> <td>5\pm0.5 sec.</td> </tr> </table>	Solder Temperature	245 \pm 5 $^{\circ}$ C	Time	5 \pm 0.5 sec.
Solder Temperature	245 \pm 5 $^{\circ}$ C				
Time	5 \pm 0.5 sec.				

13. Resistance to soldering heat

Specified Value	Inductance change : Within $\pm 10\%$ No significant abnormality in appearance.
Test Methods and Remarks	3 times reflow having the temperature profile of 5sec of 260 \pm 0/ -5° C and 40sec of more than 230 $^{\circ}$ C. Test board thickness : 1.0mm Test board material : Glass epoxy-resin Recovery : At least 2hrs of recovery under the standard condition after the test, followed by the measurement within 48hrs.

14. Thermal shock

Specified Value	Inductance change : Within $\pm 10\%$ No significant abnormality in appearance.																		
Test Methods and Remarks	The given sample is soldered to the board and then its Inductance is measured after 100cycles of the following conditions. <table border="1" data-bbox="295 1653 906 1825"> <thead> <tr> <th colspan="3">Conditions of 1 cycle</th> </tr> <tr> <th>Step</th> <th>Temperature ($^{\circ}$C)</th> <th>Duration (min)</th> </tr> </thead> <tbody> <tr> <td>1</td> <td>-40\pm3</td> <td>30\pm3</td> </tr> <tr> <td>2</td> <td>Room temperature</td> <td>Within 3</td> </tr> <tr> <td>3</td> <td>+85\pm2</td> <td>30\pm3</td> </tr> <tr> <td>4</td> <td>Room temperature</td> <td>Within 3</td> </tr> </tbody> </table> Recovery : At least 2hrs of recovery under the standard condition after the test, followed by the measurement within 48 hrs.	Conditions of 1 cycle			Step	Temperature ($^{\circ}$ C)	Duration (min)	1	-40 \pm 3	30 \pm 3	2	Room temperature	Within 3	3	+85 \pm 2	30 \pm 3	4	Room temperature	Within 3
Conditions of 1 cycle																			
Step	Temperature ($^{\circ}$ C)	Duration (min)																	
1	-40 \pm 3	30 \pm 3																	
2	Room temperature	Within 3																	
3	+85 \pm 2	30 \pm 3																	
4	Room temperature	Within 3																	

15. Damp heat

Specified Value	Inductance change : Within $\pm 10\%$ No significant abnormality in appearance.
Test Methods and Remarks	The given sample is soldered to the board and then it is kept at the following conditions.
	Temperature $60 \pm 2^\circ\text{C}$
	Humidity $90 \sim 95\% \text{RH}$
	Time 1000 hours.
Recovery : At least 2hrs of recovery under the standard condition after the test, followed by the measurement within 48 hrs.	

16. Loading under damp heat

Specified Value	Inductance change : Within $\pm 10\%$ No significant abnormality in appearance.
Test Methods and Remarks	The given sample is soldered to the board and then it is kept at the following conditions.
	Temperature $60 \pm 2^\circ\text{C}$
	Humidity $90 \sim 95\% \text{RH}$
	Applied current Rated current
	Time 1000hours.
Recovery : At least 2hrs of recovery under the standard condition after the test, followed by the measurement within 48 hrs.	

17. Low temperature life test

Specified Value	Inductance change : Within $\pm 10\%$ No significant abnormality in appearance.
Test Methods and Remarks	The given sample is soldered to the board and then it is kept at the following conditions.
	Temperature $-40 \pm 2^\circ\text{C}$
	Duration 1000hours
	Recovery : At least 2hrs of recovery under the standard condition after the test, followed by the measurement within 48 hrs.

18. High temperature life test

Specified Value	Inductance change : Within $\pm 10\%$ No significant abnormality in appearance.
Test Methods and Remarks	The given sample is soldered to the board and then it is kept at the following conditions.
	Temperature $85 \pm 2^\circ\text{C}$
	Duration 1000hours
	Recovery : At least 2hrs of recovery under the standard condition after the test, followed by the measurement within 48 hrs.

19. Standard conditions

Specified Value	Standard test condition : Unless otherwise specified, temperature is $20 \pm 15^\circ\text{C}$ and $65 \pm 20\%$ of relative humidity. When there is any question concerning measurement result: In order to provide correlation data, the test shall be condition of $20 \pm 2^\circ\text{C}$ of temperature, $65 \pm 5\%$ relative humidity. Inductance is in accordance with our measured value.
-----------------	--

► This catalog contains the typical specification only due to the limitation of space. When you consider the purchase of our products, please check our specification.
For details of each product (characteristics graph, reliability information, precautions for use, and so on), see our Web site (<http://www.ty-top.com/>).

Wire-wound Ferrite Power Inductors LSQPB/LLQPB series

■ PRECAUTIONS

1. Circuit Design

Precautions	<ul style="list-style-type: none"> ◆ Verification of operating environment, electrical rating and performance <ol style="list-style-type: none"> 1. A malfunction in medical equipment, spacecraft, nuclear reactors, etc. may cause serious harm to human life or have severe social ramifications. As such, any inductors to be used in such equipment may require higher safety and/or reliability considerations and should be clearly differentiated from components used in general purpose applications. 2. When inductors are used in places where dew condensation develops and/or where corrosive gas such as hydrogen sulfide, sulfurous acid, or chlorine exists in the air, characteristic deterioration may occur. Please do not use inductors under such environmental conditions. ◆ Operating Current (Verification of Rated current) <ol style="list-style-type: none"> 1. The operating current including inrush current for inductors must always be lower than their rated values. 2. Do not apply current in excess of the rated value because the inductance may be reduced due to the magnetic saturation effect. ◆ Temperature rise <p>Temperature rise of power choke coil depends on the installation condition in end products. Make sure that temperature rise of power choke coils in actual end products is within the specified temperature range.</p>
-------------	---

2. PCB Design

Precautions	<ul style="list-style-type: none"> ◆ Land pattern design <ol style="list-style-type: none"> 1. Please refer to a recommended land pattern.
Technical considerations	<ul style="list-style-type: none"> ◆ Land pattern design <p>Surface Mounting</p> <ol style="list-style-type: none"> 1. The conditions of the picking and placing should be checked in advance. 2. The products are only for reflow soldering.

3. Considerations for automatic placement

Precautions	<ul style="list-style-type: none"> ◆ Adjustment of mounting machine <ol style="list-style-type: none"> 1. Excessive physical impact should not be imposed on the products for picking and placing onto the PC boards. 2. Mounting and soldering conditions should be checked in advance.
Technical considerations	<ul style="list-style-type: none"> ◆ Adjustment of mounting machine <p>The products might be broken if too much stress is given for the picking and placing.</p>

4. Soldering

Precautions	<ul style="list-style-type: none"> ◆ Reflow soldering <ol style="list-style-type: none"> 1. Please apply our recommended soldering conditions on the specification as much as possible. 2. The products are only for reflow soldering. 3. Please do not give any stress to a product until it returns in room temperature after reflow soldering. ◆ Recommended conditions for using a soldering iron. (Excluding 1608 type) <p>Touch a soldering iron to the land pattern not to the product directly. The temperature of a soldering iron is less than 350degC. The soldering is for 3 seconds or less.</p>
Technical considerations	<ul style="list-style-type: none"> ◆ Reflow soldering <ol style="list-style-type: none"> 1. The product might break or might make the tombstoning, if the soldering conditions are too far from our recommended conditions. <p style="text-align: center;">Temperature [°C]</p> <p style="text-align: center;">Heating Time [sec]</p>

5. Cleaning

Precautions	<ul style="list-style-type: none"> ◆ Cleaning conditions <ol style="list-style-type: none"> 1. Please don't wash by the ultra-sonic waves.
Technical considerations	<ul style="list-style-type: none"> ◆ Cleaning conditions <ol style="list-style-type: none"> 1. Washing by the ultra-sonic waves might break the product.

▶ This catalog contains the typical specification only due to the limitation of space. When you consider the purchase of our products, please check our specification. For details of each product (characteristics graph, reliability information, precautions for use, and so on), see our Web site (<http://www.ty-top.com/>).

6. Handling

Precautions	<ul style="list-style-type: none"> ◆ Handling <ol style="list-style-type: none"> 1. Keep the product away from any magnets. ◆ Cutting the PC boards <ol style="list-style-type: none"> 1. Please don't give any stress of the bending or the twisting for the cutting process of PC boards. 2. Please don't give any shock and stress to the products in transportation. ◆ Mechanical considerations <ol style="list-style-type: none"> 1. Please don't give too much shock to the product. 2. Please don't give any shock and stress to the products in transportation. ◆ The stress for picking and placing <ol style="list-style-type: none"> 1. Please don't give any shock into an exposed ferrite core. ◆ Packing <ol style="list-style-type: none"> 1. Please don't pile the packing boxes up as much as possible.
Technical considerations	<ul style="list-style-type: none"> ◆ Handling <ol style="list-style-type: none"> 1. There is a case that a characteristic varies with magnetic influence. ◆ Cutting the PC boards <ol style="list-style-type: none"> 1. Please don't give the bending stress or the twisting stress to the products because they might break in such cases. ◆ Mechanical considerations <ol style="list-style-type: none"> 1. The mechanical shock might break the products. 2. The products might break depending on the handling in transportation. ◆ Pick-up pressure <ol style="list-style-type: none"> 1. The electrical characteristics of the products might be shifted by too much physical shock and stress. ◆ Packing <ol style="list-style-type: none"> 1. The products and the tape might break, if the packing boxes are piled up.

7. Storage conditions

Precautions	<ul style="list-style-type: none"> ◆ Storage <ol style="list-style-type: none"> 1. To maintain the solderability of terminal electrodes and to keep the packing material in good condition, temperature and humidity in the storage area should be controlled. <ul style="list-style-type: none"> ▪ Storage conditions <ul style="list-style-type: none"> Ambient temperature : 0~40°C Humidity : Below 70% RH ▪ The recommended ambient temperature is below 30°C. Even under ideal storage conditions, solderability of products electrodes may decrease as time passes. <ul style="list-style-type: none"> For this reason, product should be used within 6 months from the time of delivery. In case of storage over 6 months, solderability shall be checked before actual usage.
Technical considerations	<ul style="list-style-type: none"> ◆ Storage <ol style="list-style-type: none"> 1. The ambient of high temperature or high humidity might accelerate to make the solderability and the tape worse.

▶ This catalog contains the typical specification only due to the limitation of space. When you consider the purchase of our products, please check our specification. For details of each product (characteristics graph, reliability information, precautions for use, and so on), see our Web site (<http://www.ty-top.com/>).

医疗设备（国际（GHTF）第一类、第二类）用途 绕线型铁氧体系功率电感器 LLQN/LLQPA 系列

系列前的记号来自型号，用来区分产品的种类和特性等。

回流焊

■ 型号标示法

*使用温度范围：-40~+105°C（包含产品本身发热）

L	L	Q	N	A	2	0	1	2	1	2	T	1	0	0	M		
①	②	③	④	⑤	⑥	⑦	⑧	⑨									

①系列

代码 (1)(2)(3)(4)	
LLQN	医疗设备（国际（GHTF）第一类、第二类）用途 绕线型铁氧体系功率电感器
LLQP	医疗设备（国际（GHTF）第一类、第二类）用途 绕线型铁氧体系功率电感器

(1) 产品群

代码	
L	电感器

(2) 范畴

代码	推荐设备	品质等级
L	医疗设备（国际（GHTF）第一类、第二类）	3

②特征

代码	特征
A	5面电极（树脂银×镀锡）
B	L字电极（树脂银×镀锡）

③尺寸（L×W）

代码	外型（inch）	尺寸（L×W）[mm]
1608	1608（0603）	1.6×0.8
2012	2012（0805）	2.0×1.25
2016	2016（0806）	2.0×1.6
2518	2518（1007）	2.5×1.8
3225	3225（1210）	3.2×2.5

④尺寸（T）

代码	尺寸（T）[mm]
08	0.8
09	0.9
12	1.25
16	1.6
18	1.8
25	2.5

(3) 类型

代码	
Q	绕线型铁氧体系 横型

(4) 特效 / 特性

代码	
N	一般功率扼流
P	大电流功率扼流

⑤包装

代码	包装
T	卷盘带装

⑥标称电感值

代码（例）	标称电感值 [μH]
1R0	1.0
100	10
101	100

※R=小数点

⑦电感量公差

代码	电感量公差
K	±10%
M	±20%

⑧个别规格

代码	个别规格
R	低 Rdc 品

⑨管理记号

■标准外型尺寸 / 标准数量

5 面电极产品

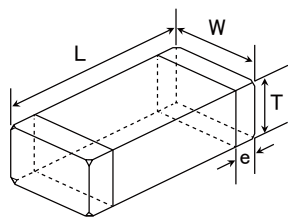

L 字电极品

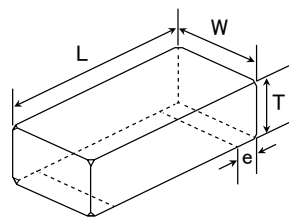

推荐焊盘图案

实装上的注意

- 请确认实装状态后使用。
- 本产品焊法限定为回流焊法。



Type	A	B	C
B1608	0.55	0.7	1.0
A2012	0.60	1.0	1.45
A2016	0.60	1.0	1.8
A2518	0.60	1.5	2.0
A3225	0.85	1.7	2.7

单位: mm

Type	L	W	T	e	标准数量 [pcs]	
					纸带	压模带
B160808	1.6±0.2 (0.063±0.008)	0.8±0.2 (0.031±0.008)	0.8±0.2 (0.031±0.008)	0.45±0.15 (0.016±0.006)	—	3000
A201209	2.0±0.2 (0.079±0.008)	1.25±0.2 (0.049±0.008)	0.9±0.1 (0.035±0.004)	0.5±0.2 (0.020±0.008)	4000	—
A201212	2.0±0.2 (0.079±0.008)	1.25±0.2 (0.049±0.008)	1.25±0.2 (0.049±0.008)	0.5±0.2 (0.020±0.008)	—	3000
A201616	2.0±0.2 (0.079±0.008)	1.6±0.2 (0.063±0.008)	1.6±0.2 (0.063±0.008)	0.5±0.2 (0.020±0.008)	—	2000
A251818	2.5±0.2 (0.098±0.008)	1.8±0.2 (0.071±0.008)	1.8±0.2 (0.071±0.008)	0.5±0.2 (0.020±0.008)	—	2000
A322525	3.2±0.2 (0.126±0.008)	2.5±0.2 (0.098±0.008)	2.5±0.2 (0.098±0.008)	0.6±0.3 (0.024±0.012)	—	1000

单位: mm (inch)

PART NUMBER

● 1608 (0603) type

New part number	Old part number (for reference)	EHS	Nominal inductance [μ H]	Inductance tolerance	Self-resonant frequency [MHz] (min.)	DC Resistance [Ω] (\pm 30%)	Rated current ※) [mA]		Measuring frequency [MHz]
							Saturation current Idc1	Temperature rise current Idc2	
LLQNB160808T1R0M	CBMF1608T1R0M	RoHS	1.0	\pm 20%	100	0.09	290	770	7.96
LLQNB160808T2R2M	CBMF1608T2R2M	RoHS	2.2	\pm 20%	80	0.17	190	560	7.96
LLQNB160808T3R3M	CBMF1608T3R3M	RoHS	3.3	\pm 20%	60	0.22	170	500	7.96
LLQNB160808T4R7M	CBMF1608T4R7M	RoHS	4.7	\pm 20%	45	0.24	145	470	7.96
LLQNB160808T100K	CBMF1608T100K	RoHS	10	\pm 10%	32	0.36	115	380	2.52
LLQNB160808T100M	CBMF1608T100M	RoHS	10	\pm 20%	32	0.36	115	380	2.52
LLQNB160808T220K	CBMF1608T220K	RoHS	22	\pm 10%	16	1.0	70	230	2.52
LLQNB160808T220M	CBMF1608T220M	RoHS	22	\pm 20%	16	1.0	70	230	2.52
LLQNB160808T470K	CBMF1608T470K	RoHS	47	\pm 10%	11	2.5	50	140	2.52
LLQNB160808T470M	CBMF1608T470M	RoHS	47	\pm 20%	11	2.5	50	140	2.52

● 2012 (0805) type

New part number	Old part number (for reference)	EHS	Nominal inductance [μ H]	Inductance tolerance	Self-resonant frequency [MHz] (min.)	DC Resistance [Ω] (\pm 30%)	Rated current ※) [mA]		Measuring frequency [MHz]
							Saturation current Idc1	Temperature rise current Idc2	
LLQNA201212T1R0M	CB 2012T1R0M	RoHS	1.0	\pm 20%	100	0.15	500	900	7.96
LLQNA201212T2R2M	CB 2012T2R2M	RoHS	2.2	\pm 20%	80	0.23	410	770	7.96
LLQNA201212T3R3M	CB 2012T3R3M	RoHS	3.3	\pm 20%	55	0.30	330	650	7.96
LLQNA201212T4R7M	CB 2012T4R7M	RoHS	4.7	\pm 20%	45	0.40	300	580	7.96
LLQNA201212T6R8M	CB 2012T6R8M	RoHS	6.8	\pm 20%	38	0.47	250	540	7.96
LLQNA201212T100K	CB 2012T100K	RoHS	10	\pm 10%	32	0.70	190	440	2.52
LLQNA201212T100M	CB 2012T100M	RoHS	10	\pm 20%	32	0.70	190	440	2.52
LLQNA201212T100KR	CB 2012T100KR	RoHS	10	\pm 10%	32	0.50	200	520	2.52
LLQNA201212T100MR	CB 2012T100MR	RoHS	10	\pm 20%	32	0.50	200	520	2.52
LLQNA201212T150K	CB 2012T150K	RoHS	15	\pm 10%	28	1.3	170	320	2.52
LLQNA201212T150M	CB 2012T150M	RoHS	15	\pm 20%	28	1.3	170	320	2.52
LLQNA201212T220K	CB 2012T220K	RoHS	22	\pm 10%	16	1.7	135	280	2.52
LLQNA201212T220M	CB 2012T220M	RoHS	22	\pm 20%	16	1.7	135	280	2.52
LLQNA201212T470K	CB 2012T470K	RoHS	47	\pm 10%	11	3.7	90	190	2.52
LLQNA201212T470M	CB 2012T470M	RoHS	47	\pm 20%	11	3.7	90	190	2.52
LLQNA201212T680K	CB 2012T680K	RoHS	68	\pm 10%	10	6.0	70	140	2.52
LLQNA201212T680M	CB 2012T680M	RoHS	68	\pm 20%	10	6.0	70	140	2.52
LLQNA201212T101K	CB 2012T101K	RoHS	100	\pm 10%	8	7.0	60	130	0.796
LLQNA201212T101M	CB 2012T101M	RoHS	100	\pm 20%	8	7.0	60	130	0.796

New part number	Old part number (for reference)	EHS	Nominal inductance [μ H]	Inductance tolerance	Self-resonant frequency [MHz] (min.)	DC Resistance [Ω] (\pm 30%)	Rated current ※) [mA]		Measuring frequency [MHz]
							Saturation current Idc1	Temperature rise current Idc2	
LLQPA201212T1R0M	CB C2012T1R0M	RoHS	1.0	\pm 20%	100	0.19	700	840	7.96
LLQPA201212T2R2M	CB C2012T2R2M	RoHS	2.2	\pm 20%	70	0.33	530	640	7.96
LLQPA201212T4R7M	CB C2012T4R7M	RoHS	4.7	\pm 20%	45	0.50	360	520	7.96
LLQPA201212T100K	CB C2012T100K	RoHS	10	\pm 10%	40	1.2	240	340	2.52
LLQPA201212T100M	CB C2012T100M	RoHS	10	\pm 20%	40	1.2	240	340	2.52
LLQPA201212T220K	CB C2012T220K	RoHS	22	\pm 10%	16	3.7	170	190	2.52
LLQPA201212T220M	CB C2012T220M	RoHS	22	\pm 20%	16	3.7	170	190	2.52
LLQPA201212T470K	CB C2012T470K	RoHS	47	\pm 10%	11	5.8	120	150	2.52
LLQPA201212T470M	CB C2012T470M	RoHS	47	\pm 20%	11	5.8	120	150	2.52

New part number	Old part number (for reference)	EHS	Nominal inductance [μ H]	Inductance tolerance	Self-resonant frequency [MHz] (min.)	DC Resistance [Ω] (\pm 30%)	Rated current ※) [mA]		Measuring frequency [MHz]
							Saturation current Idc1	Temperature rise current Idc2	
LLQNA201209T1R0M	CB L2012T1R0M	RoHS	1.0	\pm 20%	100	0.15	620	950	0.1
LLQNA201209T2R2M	CB L2012T2R2M	RoHS	2.2	\pm 20%	80	0.39	440	590	0.1
LLQNA201209T4R7M	CB L2012T4R7M	RoHS	4.7	\pm 20%	45	0.66	275	490	0.1
LLQNA201209T100M	CB L2012T100M	RoHS	10	\pm 20%	32	1.0	205	370	0.1
LLQNA201209T220M	CB L2012T220M	RoHS	22	\pm 20%	23	2.1	150	250	0.1
LLQNA201209T470M	CB L2012T470M	RoHS	47	\pm 20%	11	4.2	100	140	0.1

※) The saturation current value (Idc1) is the DC current value having inductance decrease down to 30%. (at 20°C)

※) The temperature rise current value (Idc2) is the DC current value having temperature increase by 40°C. (at 20°C)

※) The rated current value is following either Idc1 or Idc2, which is the lower one.

PART NUMBER

●2016 (0806) type

New part number	Old part number (for reference)	EHS	Nominal inductance [μ H]	Inductance tolerance	Self-resonant frequency [MHz] (min.)	DC Resistance [Ω] ($\pm 30\%$)	Rated current ※) [mA]		Measuring frequency [MHz]
							Saturation current Idc1	Temperature rise current Idc2	
LLQNA201616T1R0M	CB 2016T1R0M	RoHS	1.0	$\pm 20\%$	100	0.09	600	1,100	7.96
LLQNA201616T1R5M	CB 2016T1R5M	RoHS	1.5	$\pm 20\%$	80	0.11	550	1,000	7.96
LLQNA201616T2R2M	CB 2016T2R2M	RoHS	2.2	$\pm 20\%$	70	0.13	510	1,000	7.96
LLQNA201616T3R3M	CB 2016T3R3M	RoHS	3.3	$\pm 20\%$	55	0.20	400	800	7.96
LLQNA201616T4R7M	CB 2016T4R7M	RoHS	4.7	$\pm 20\%$	45	0.25	340	740	7.96
LLQNA201616T6R8M	CB 2016T6R8M	RoHS	6.8	$\pm 20\%$	38	0.35	300	600	7.96
LLQNA201616T100K	CB 2016T100K	RoHS	10	$\pm 10\%$	32	0.50	250	520	2.52
LLQNA201616T100M	CB 2016T100M	RoHS	10	$\pm 20\%$	32	0.50	250	520	2.52
LLQNA201616T150K	CB 2016T150K	RoHS	15	$\pm 10\%$	28	0.70	210	440	2.52
LLQNA201616T150M	CB 2016T150M	RoHS	15	$\pm 20\%$	28	0.70	210	440	2.52
LLQNA201616T220K	CB 2016T220K	RoHS	22	$\pm 10\%$	16	1.0	165	370	2.52
LLQNA201616T220M	CB 2016T220M	RoHS	22	$\pm 20\%$	16	1.0	165	370	2.52
LLQNA201616T330K	CB 2016T330K	RoHS	33	$\pm 10\%$	14	1.7	130	270	2.52
LLQNA201616T330M	CB 2016T330M	RoHS	33	$\pm 20\%$	14	1.7	130	270	2.52
LLQNA201616T470K	CB 2016T470K	RoHS	47	$\pm 10\%$	11	2.4	110	240	2.52
LLQNA201616T470M	CB 2016T470M	RoHS	47	$\pm 20\%$	11	2.4	110	240	2.52
LLQNA201616T680K	CB 2016T680K	RoHS	68	$\pm 10\%$	10	3.0	90	210	2.52
LLQNA201616T680M	CB 2016T680M	RoHS	68	$\pm 20\%$	10	3.0	90	210	2.52
LLQNA201616T101K	CB 2016T101K	RoHS	100	$\pm 10\%$	8	4.5	70	170	0.796
LLQNA201616T101M	CB 2016T101M	RoHS	100	$\pm 20\%$	8	4.5	70	170	0.796

New part number	Old part number (for reference)	EHS	Nominal inductance [μ H]	Inductance tolerance	Self-resonant frequency [MHz] (min.)	DC Resistance [Ω] ($\pm 30\%$)	Rated current ※) [mA]		Measuring frequency [MHz]
							Saturation current Idc1	Temperature rise current Idc2	
LLQPA201616T1R0M	CB C2016T1R0M	RoHS	1.0	$\pm 20\%$	100	0.10	1,100	1,100	7.96
LLQPA201616T1R5M	CB C2016T1R5M	RoHS	1.5	$\pm 20\%$	80	0.15	1,000	1,000	7.96
LLQPA201616T2R2M	CB C2016T2R2M	RoHS	2.2	$\pm 20\%$	70	0.20	750	720	7.96
LLQPA201616T3R3M	CB C2016T3R3M	RoHS	3.3	$\pm 20\%$	55	0.27	600	610	7.96
LLQPA201616T4R7M	CB C2016T4R7M	RoHS	4.7	$\pm 20\%$	45	0.37	550	530	7.96
LLQPA201616T6R8M	CB C2016T6R8M	RoHS	6.8	$\pm 20\%$	38	0.59	450	450	7.96
LLQPA201616T100K	CB C2016T100K	RoHS	10	$\pm 10\%$	32	0.82	380	350	2.52
LLQPA201616T100M	CB C2016T100M	RoHS	10	$\pm 20\%$	32	0.82	380	350	2.52
LLQPA201616T150K	CB C2016T150K	RoHS	15	$\pm 10\%$	28	1.2	300	300	2.52
LLQPA201616T150M	CB C2016T150M	RoHS	15	$\pm 20\%$	28	1.2	300	300	2.52
LLQPA201616T220K	CB C2016T220K	RoHS	22	$\pm 10\%$	16	1.8	250	240	2.52
LLQPA201616T220M	CB C2016T220M	RoHS	22	$\pm 20\%$	16	1.8	250	240	2.52
LLQPA201616T330K	CB C2016T330K	RoHS	33	$\pm 10\%$	14	2.8	220	220	2.52
LLQPA201616T330M	CB C2016T330M	RoHS	33	$\pm 20\%$	14	2.8	220	220	2.52
LLQPA201616T470K	CB C2016T470K	RoHS	47	$\pm 10\%$	11	4.3	150	150	2.52
LLQPA201616T470M	CB C2016T470M	RoHS	47	$\pm 20\%$	11	4.3	150	150	2.52
LLQPA201616T680K	CB C2016T680K	RoHS	68	$\pm 10\%$	10	7.0	130	130	2.52
LLQPA201616T680M	CB C2016T680M	RoHS	68	$\pm 20\%$	10	7.0	130	130	2.52
LLQPA201616T101K	CB C2016T101K	RoHS	100	$\pm 10\%$	8	8.0	110	110	0.796
LLQPA201616T101M	CB C2016T101M	RoHS	100	$\pm 20\%$	8	8.0	110	110	0.796

※) The saturation current value (Idc1) is the DC current value having inductance decrease down to 30%. (at 20°C)

※) The temperature rise current value (Idc2) is the DC current value having temperature increase by 40°C. (at 20°C)

※) The rated current value is following either Idc1 or Idc2, which is the lower one.

■ PART NUMBER

● 2518(1007) type

New part number	Old part number (for reference)	EHS	Nominal inductance [μ H]	Inductance tolerance	Self-resonant frequency [MHz] (min.)	DC Resistance [Ω] (\pm 30%)	Rated current ※) [mA]		Measuring frequency [MHz]
							Saturation current Idc1	Temperature rise current Idc2	
LLQNA251818T1R0M	CB 2518T1R0M	RoHS	1.0	\pm 20%	100	0.06	1,200	1,500	7.96
LLQNA251818T1R5M	CB 2518T1R5M	RoHS	1.5	\pm 20%	80	0.07	650	1,400	7.96
LLQNA251818T2R2M	CB 2518T2R2M	RoHS	2.2	\pm 20%	68	0.09	510	1,300	7.96
LLQNA251818T3R3M	CB 2518T3R3M	RoHS	3.3	\pm 20%	54	0.11	440	1,200	7.96
LLQNA251818T4R7MR	CB 2518T4R7MR	RoHS	4.7	\pm 20%	46	0.10	310	1,200	7.96
LLQNA251818T4R7M	CB 2518T4R7M	RoHS	4.7	\pm 20%	46	0.13	340	1,100	7.96
LLQNA251818T6R8M	CB 2518T6R8M	RoHS	6.8	\pm 20%	38	0.15	270	930	7.96
LLQNA251818T100K	CB 2518T100K	RoHS	10	\pm 10%	30	0.25	250	820	2.52
LLQNA251818T100M	CB 2518T100M	RoHS	10	\pm 20%	30	0.25	250	820	2.52
LLQNA251818T150K	CB 2518T150K	RoHS	15	\pm 10%	23	0.32	180	650	2.52
LLQNA251818T150M	CB 2518T150M	RoHS	15	\pm 20%	23	0.32	180	650	2.52
LLQNA251818T220K	CB 2518T220K	RoHS	22	\pm 10%	19	0.50	165	580	2.52
LLQNA251818T220M	CB 2518T220M	RoHS	22	\pm 20%	19	0.50	165	580	2.52
LLQNA251818T330K	CB 2518T330K	RoHS	33	\pm 10%	15	0.70	130	460	2.52
LLQNA251818T330M	CB 2518T330M	RoHS	33	\pm 20%	15	0.70	130	460	2.52
LLQNA251818T470K	CB 2518T470K	RoHS	47	\pm 10%	12	0.95	110	420	2.52
LLQNA251818T470M	CB 2518T470M	RoHS	47	\pm 20%	12	0.95	110	420	2.52
LLQNA251818T680K	CB 2518T680K	RoHS	68	\pm 10%	9.5	1.5	70	310	2.52
LLQNA251818T680M	CB 2518T680M	RoHS	68	\pm 20%	9.5	1.5	70	310	2.52
LLQNA251818T101K	CB 2518T101K	RoHS	100	\pm 10%	9.0	2.1	60	260	0.796
LLQNA251818T101M	CB 2518T101M	RoHS	100	\pm 20%	9.0	2.1	60	260	0.796
LLQNA251818T151K	CB 2518T151K	RoHS	150	\pm 10%	7.0	3.2	55	210	0.796
LLQNA251818T151M	CB 2518T151M	RoHS	150	\pm 20%	7.0	3.2	55	210	0.796
LLQNA251818T221K	CB 2518T221K	RoHS	220	\pm 10%	5.5	4.5	50	180	0.796
LLQNA251818T221M	CB 2518T221M	RoHS	220	\pm 20%	5.5	4.5	50	180	0.796
LLQNA251818T331K	CB 2518T331K	RoHS	330	\pm 10%	4.5	7.0	40	140	0.796
LLQNA251818T331M	CB 2518T331M	RoHS	330	\pm 20%	4.5	7.0	40	140	0.796
LLQNA251818T471K	CB 2518T471K	RoHS	470	\pm 10%	3.5	10	35	120	0.796
LLQNA251818T471M	CB 2518T471M	RoHS	470	\pm 20%	3.5	10	35	120	0.796
LLQNA251818T681K	CB 2518T681K	RoHS	680	\pm 10%	3.0	17	30	90	0.796
LLQNA251818T681M	CB 2518T681M	RoHS	680	\pm 20%	3.0	17	30	90	0.796
LLQNA251818T102K	CB 2518T102K	RoHS	1000	\pm 10%	2.4	24	25	75	0.252
LLQNA251818T102M	CB 2518T102M	RoHS	1000	\pm 20%	2.4	24	25	75	0.252

New part number	Old part number (for reference)	EHS	Nominal inductance [μ H]	Inductance tolerance	Self-resonant frequency [MHz] (min.)	DC Resistance [Ω] (\pm 30%)	Rated current ※) [mA]		Measuring frequency [MHz]
							Saturation current Idc1	Temperature rise current Idc2	
LLQPA251818T1R0M	CB C2518T1R0M	RoHS	1.0	\pm 20%	100	0.08	1,000	1,200	7.96
LLQPA251818T1R5M	CB C2518T1R5M	RoHS	1.5	\pm 20%	80	0.11	950	1,190	7.96
LLQPA251818T2R2M	CB C2518T2R2M	RoHS	2.2	\pm 20%	68	0.13	890	1,100	7.96
LLQPA251818T3R3M	CB C2518T3R3M	RoHS	3.3	\pm 20%	54	0.16	730	1,020	7.96
LLQPA251818T4R7M	CB C2518T4R7M	RoHS	4.7	\pm 20%	41	0.20	680	920	7.96
LLQPA251818T6R8M	CB C2518T6R8M	RoHS	6.8	\pm 20%	38	0.30	550	740	7.96
LLQPA251818T100K	CB C2518T100K	RoHS	10	\pm 10%	30	0.36	480	680	2.52
LLQPA251818T100M	CB C2518T100M	RoHS	10	\pm 20%	30	0.36	480	680	2.52
LLQPA251818T150K	CB C2518T150K	RoHS	15	\pm 10%	23	0.65	350	500	2.52
LLQPA251818T150M	CB C2518T150M	RoHS	15	\pm 20%	23	0.65	350	500	2.52
LLQPA251818T220K	CB C2518T220K	RoHS	22	\pm 10%	19	0.77	320	460	2.52
LLQPA251818T220M	CB C2518T220M	RoHS	22	\pm 20%	19	0.77	320	460	2.52
LLQPA251818T330K	CB C2518T330K	RoHS	33	\pm 10%	15	1.5	270	320	2.52
LLQPA251818T330M	CB C2518T330M	RoHS	33	\pm 20%	15	1.5	270	320	2.52
LLQPA251818T470K	CB C2518T470K	RoHS	47	\pm 10%	12	1.9	240	290	2.52
LLQPA251818T470M	CB C2518T470M	RoHS	47	\pm 20%	12	1.9	240	290	2.52
LLQPA251818T680K	CB C2518T680K	RoHS	68	\pm 10%	9.5	2.8	200	200	2.52
LLQPA251818T680M	CB C2518T680M	RoHS	68	\pm 20%	9.5	2.8	200	200	2.52
LLQPA251818T101K	CB C2518T101K	RoHS	100	\pm 10%	9.0	3.7	160	170	0.796
LLQPA251818T101M	CB C2518T101M	RoHS	100	\pm 20%	9.0	3.7	160	170	0.796
LLQPA251818T151K	CB C2518T151K	RoHS	150	\pm 10%	7.0	6.1	140	130	0.796
LLQPA251818T151M	CB C2518T151M	RoHS	150	\pm 20%	7.0	6.1	140	130	0.796
LLQPA251818T221K	CB C2518T221K	RoHS	220	\pm 10%	5.5	8.4	115	110	0.796
LLQPA251818T221M	CB C2518T221M	RoHS	220	\pm 20%	5.5	8.4	115	110	0.796
LLQPA251818T331K	CB C2518T331K	RoHS	330	\pm 10%	4.5	12.3	100	90	0.796
LLQPA251818T331M	CB C2518T331M	RoHS	330	\pm 20%	4.5	12.3	100	90	0.796
LLQPA251818T471K	CB C2518T471K	RoHS	470	\pm 10%	3.5	22	80	70	0.796
LLQPA251818T471M	CB C2518T471M	RoHS	470	\pm 20%	3.5	22	80	70	0.796
LLQPA251818T681K	CB C2518T681K	RoHS	680	\pm 10%	3.0	28	65	60	0.796
LLQPA251818T681M	CB C2518T681M	RoHS	680	\pm 20%	3.0	28	65	60	0.796

※) The saturation current value (Idc1) is the DC current value having inductance decrease down to 30%. (at 20°C)

※) The temperature rise current value (Idc2) is the DC current value having temperature increase by 40°C. (at 20°C)

※) The rated current value is following either Idc1 or Idc2, which is the lower one.

PART NUMBER

3225(1210) type

New part number	Old part number (for reference)	EHS	Nominal inductance [μ H]	Inductance tolerance	Self-resonant frequency [MHz] (min.)	DC Resistance [Ω] ($\pm 30\%$)	Rated current ※) [mA]		Measuring frequency [MHz]
							Saturation current Idc1	Temperature rise current Idc2	
LLQPA322525T1R0MR	CB C3225T1R0MR	RoHS	1.0	$\pm 20\%$	250	0.055	2,000	1,440	0.1
LLQPA322525T1R5MR	CB C3225T1R5MR	RoHS	1.5	$\pm 20\%$	220	0.060	2,000	1,310	0.1
LLQPA322525T2R2MR	CB C3225T2R2MR	RoHS	2.2	$\pm 20\%$	190	0.080	2,000	1,130	0.1
LLQPA322525T3R3MR	CB C3225T3R3MR	RoHS	3.3	$\pm 20\%$	160	0.095	2,000	1,040	0.1
LLQPA322525T4R7MR	CB C3225T4R7MR	RoHS	4.7	$\pm 20\%$	70	0.100	1,250	1,010	0.1
LLQPA322525T6R8MR	CB C3225T6R8MR	RoHS	6.8	$\pm 20\%$	50	0.120	950	940	0.1
LLQPA322525T100KR	CB C3225T100KR	RoHS	10	$\pm 10\%$	23	0.133	900	900	0.1
LLQPA322525T100MR	CB C3225T100MR	RoHS	10	$\pm 20\%$	23	0.133	900	900	0.1
LLQPA322525T150KR	CB C3225T150KR	RoHS	15	$\pm 10\%$	20	0.195	730	850	0.1
LLQPA322525T150MR	CB C3225T150MR	RoHS	15	$\pm 20\%$	20	0.195	730	850	0.1
LLQPA322525T220KR	CB C3225T220KR	RoHS	22	$\pm 10\%$	17	0.27	620	780	0.1
LLQPA322525T220MR	CB C3225T220MR	RoHS	22	$\pm 20\%$	17	0.27	620	780	0.1
LLQPA322525T330KR	CB C3225T330KR	RoHS	33	$\pm 10\%$	13	0.41	500	570	0.1
LLQPA322525T330MR	CB C3225T330MR	RoHS	33	$\pm 20\%$	13	0.41	500	570	0.1
LLQPA322525T470KR	CB C3225T470KR	RoHS	47	$\pm 10\%$	10	0.67	390	480	0.1
LLQPA322525T470MR	CB C3225T470MR	RoHS	47	$\pm 20\%$	10	0.67	390	480	0.1
LLQPA322525T680KR	CB C3225T680KR	RoHS	68	$\pm 10\%$	8.0	1.0	320	410	0.1
LLQPA322525T680MR	CB C3225T680MR	RoHS	68	$\pm 20\%$	8.0	1.0	320	410	0.1
LLQPA322525T101KR	CB C3225T101KR	RoHS	100	$\pm 10\%$	6.0	1.4	270	340	0.1
LLQPA322525T101MR	CB C3225T101MR	RoHS	100	$\pm 20\%$	6.0	1.4	270	340	0.1
LLQPA322525T221KR	CB C3225T221KR	RoHS	220	$\pm 10\%$	3.0	2.5	190	190	0.1
LLQPA322525T221MR	CB C3225T221MR	RoHS	220	$\pm 20\%$	3.0	2.5	190	190	0.1
LLQPA322525T821KR	CB C3225T821KR	RoHS	820	$\pm 10\%$	1.8	12	110	110	0.1
LLQPA322525T821MR	CB C3225T821MR	RoHS	820	$\pm 20\%$	1.8	12	110	110	0.1
LLQPA322525T102KR	CB C3225T102KR	RoHS	1000	$\pm 10\%$	1.6	13	100	100	0.1
LLQPA322525T102MR	CB C3225T102MR	RoHS	1000	$\pm 20\%$	1.6	13	100	100	0.1

※) The saturation current value (Idc1) is the DC current value having inductance decrease down to 30%. (at 20°C)

※) The temperature rise current value (Idc2) is the DC current value having temperature increase by 40°C. (at 20°C)

※) The rated current value is following either Idc1 or Idc2, which is the lower one.

Wire-wound Ferrite Inductors LSQB/LSQC/LSQE/LLQB/LLQC/LLQE/LMQB/LMQC/LMQE/
LBQB/LBQC/LBQE series

Wire-wound Ferrite Power Inductors LSQN/LSQPA/LLQN/LLQPA/LMQN/LMQPA/
LBQN/LBQPA series

Wire-wound Ferrite Inductors for Signal Lines LSQM/LLQM/LMQM/LBQM series

■ PACKAGING

① Minimum Quantity

Type	Standard Quantity [pcs]	
	Paper Tape	Embossed Tape
A322525	—	1000
A321818	—	2000
A251818	—	2000
B201616	—	2000
A201616	—	2000
A201212	—	3000
A201209	4000	—
A160808	4000	—
B160808	—	3000

② Tape material

● Embossed tape

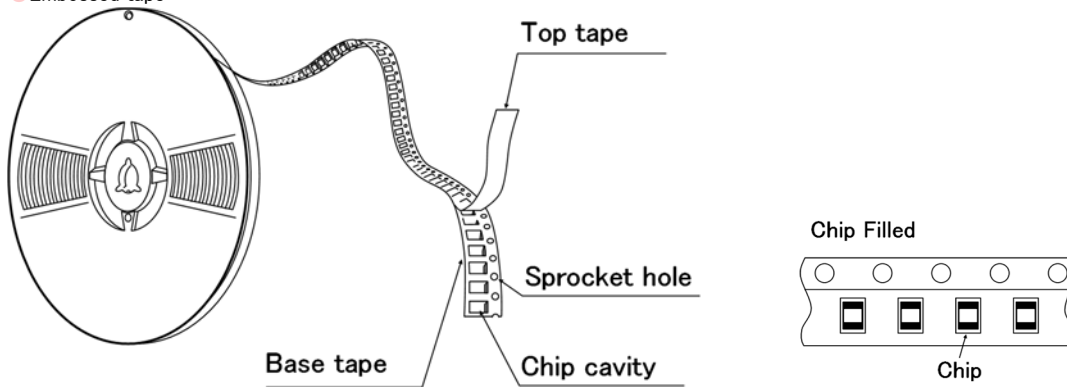

● Card board carrier tape

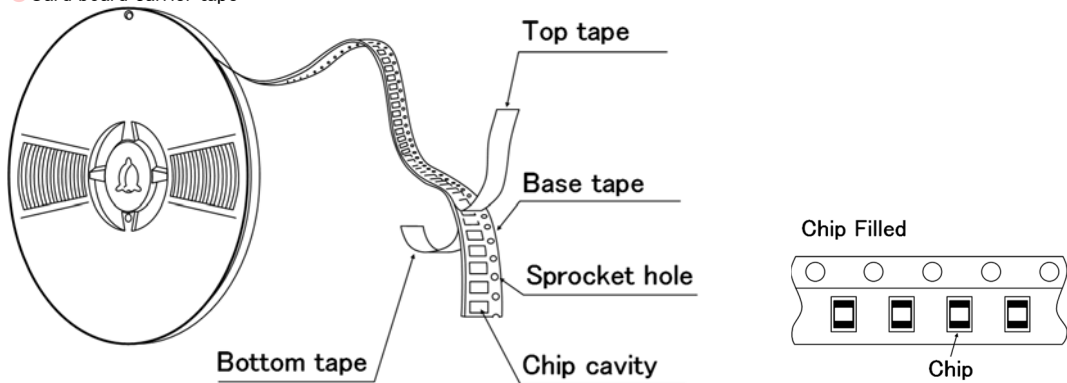

► This catalog contains the typical specification only due to the limitation of space. When you consider the purchase of our products, please check our specification. For details of each product (characteristics graph, reliability information, precautions for use, and so on), see our Web site (<http://www.ty-top.com/>).

③ Taping Dimensions

● Embossed Tape (0.315 inches wide)

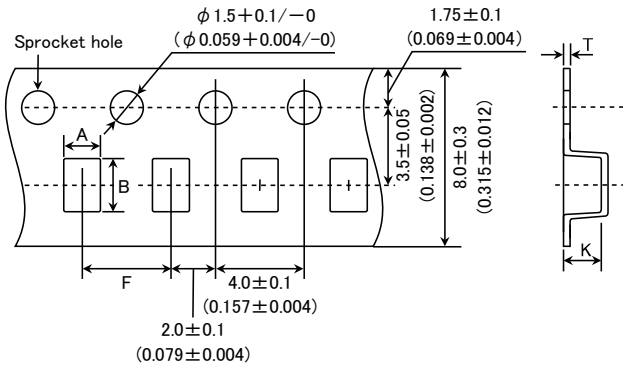

Type	Chip cavity		Insertion pitch F	Tape thickness	
	A	B		T	K
B201616	1.75±0.1 (0.069±0.004)	2.1±0.1 (0.083±0.004)	4.0±0.1 (0.157±0.004)	0.3±0.05 (0.012±0.002)	1.9max. (0.075max.)
A322525	2.8±0.1 (0.110±0.004)	3.5±0.1 (0.138±0.004)	4.0±0.1 (0.157±0.004)	0.3±0.05 (0.012±0.002)	4.0max. (0.157max.)
A321818	2.1±0.1 (0.083±0.004)	3.5±0.1 (0.138±0.004)	4.0±0.1 (0.157±0.004)	0.3±0.05 (0.012±0.002)	2.2max. (0.087max.)
A251818	2.15±0.1 (0.085±0.004)	2.7±0.1 (0.106±0.004)	4.0±0.1 (0.157±0.004)	0.3±0.05 (0.012±0.002)	2.2max. (0.087max.)
A201616	1.75±0.1 (0.069±0.004)	2.1±0.1 (0.083±0.004)	4.0±0.1 (0.157±0.004)	0.3±0.05 (0.012±0.002)	1.9max. (0.075max.)
A201212	1.45±0.1 (0.057±0.004)	2.25±0.1 (0.089±0.004)	4.0±0.1 (0.157±0.004)	0.25±0.05 (0.010±0.002)	1.45max. (0.057max.)
B160808	1.1±0.1 (0.043±0.004)	1.9±0.1 (0.075±0.004)	4.0±0.1 (0.157±0.004)	0.25±0.05 (0.010±0.002)	1.2max. (0.047max.)

Unit : mm (inch)

● Card board carrier tape (0.315 inches wide)

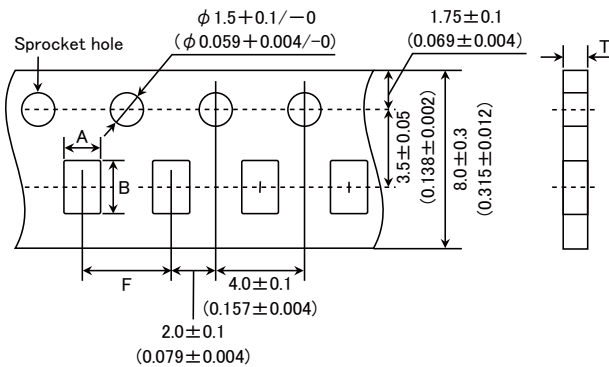

Type	Chip cavity		Insertion pitch F	Tape thickness
	A	B		T
A201209	1.55±0.1 (0.061±0.004)	2.3±0.1 (0.091±0.004)	4.0±0.1 (0.157±0.004)	1.1max. (0.043max.)
A160808	1.0±0.1 (0.039±0.004)	1.8±0.1 (0.071±0.004)	4.0±0.1 (0.157±0.004)	1.1max. (0.043max.)

Unit : mm (inch)

④ Leader and Blank Portion

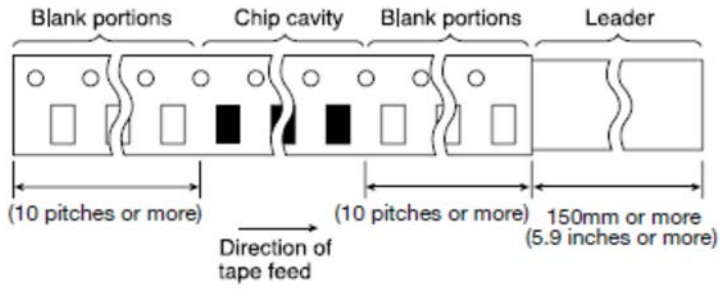

⑤ Reel Size

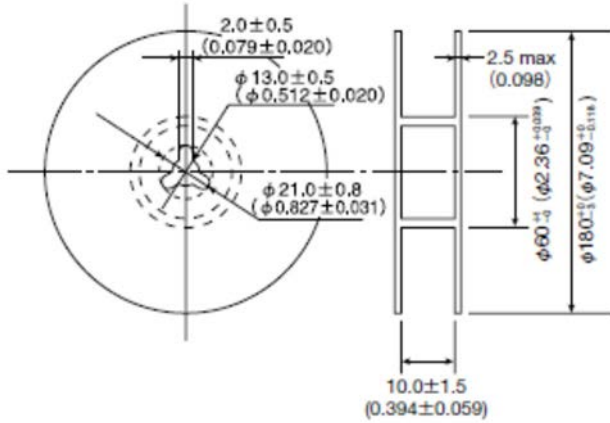

⑥ Top Tape Strength

The top tape requires a peel-off force 0.1 to 1.0N in the direction of the arrow as illustrated below.

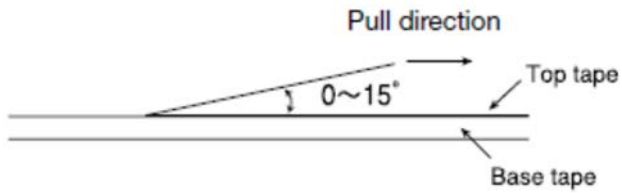

► This catalog contains the typical specification only due to the limitation of space. When you consider the purchase of our products, please check our specification. For details of each product (characteristics graph, reliability information, precautions for use, and so on), see our Web site (<http://www.ty-top.com/>).

Wire-wound Ferrite Inductors LSQB/LSQC/LSQE series

for General Electronic Equipment for Consumer

Wire-wound Ferrite Power Inductors LSQN/LSQPA series

for General Electronic Equipment for Consumer

Wire-wound Ferrite Inductors for Signal Lines LSQM series

for General Electronic Equipment for Consumer

Wire-wound Ferrite Inductors LLQB/LLQC/LLQE series

for Medical Devices classified as GHTF Classes A or B (Japan Classes I or II)

Wire-wound Ferrite Power Inductors LLQN/LLQPA series

for Medical Devices classified as GHTF Classes A or B (Japan Classes I or II)

Wire-wound Ferrite Inductors for Signal Lines LLQM series

for Medical Devices classified as GHTF Classes A or B (Japan Classes I or II)

■ RELIABILITY DATA

1. Operating temperature Range

Specified Value -40~+105°C (Including self-generated heat)

2. Storage Temperature Range (after soldering)

Specified Value -40~+85°C

Test Methods and Remarks Wire-wound Ferrite Inductors, Wire-wound Ferrite Power Inductors
Please refer the term of "7. storage conditions" in precautions.

3. Rated Current

Specified Value Within the specified tolerance

4. Inductance

Specified Value Within the specified tolerance

Test Methods and Remarks Measuring equipment : LCR Meter (HP4285A or its equivalent)
Measuring frequency : Specified frequency

5. Q

Specified Value Wire-wound Ferrite Inductors for Signal Lines:
Within the specified tolerance

Test Methods and Remarks Wire-wound Ferrite Inductors for Signal Lines:
Measuring equipment : LCR Meter (HP4285A or its equivalent)
Measuring frequency : Specified frequency

6. DC Resisitance

Specified Value Within the specified tolerance

Test Methods and Remarks Measuring equipment : DC Ohmmeter (HIOKI 3227 or its equivalent)

7. Self-Resonant Frequency

Specified Value Within the specified tolerance

Test Methods and Remarks Measuring equipment : Impedance analyzer (HP4291A or its equivalent)

▶ This catalog contains the typical specification only due to the limitation of space. When you consider the purchase of our products, please check our specification.
For details of each product (characteristics graph, reliability information, precautions for use, and so on), see our Web site (<http://www.ty-top.com/>).

8.Temperature Characteristic					
Specified Value	LSQMB2016				Inductance change : Within $\pm 5\%$
	LLQMB2016				
	LSQBA1608 LSQBA2012 LSQEA2012 LSQNA2012				Inductance change : Within $\pm 20\%$
	LSQNA2012 LSQBA2016 LSQNA2016 LSQBA2518				
	LSQEA2518 LSQNA2518 LSQCA3225 LSQPA3225				
	LLQBA2016 LLQBA2012 LLQEA2012 LLQNA2012				
	LLQNA2012 LLQBA2016 LLQNA2016 LLQBA2518				
	LLQEA2518 LLQNA2518 LLQCA3225 LLQPA3225				
	LSQBB1608 LSQNB1608 LSQCA2016 LSQPA2016				Inductance change : Within $\pm 25\%$
	LSQCA2518 LSQPA2518 LSQBA3218				
LLQBB1608 LLQNB1608 LLQCA2016 LLQPA2016					
LLQCA2518 LLQPA2518 LLQBA3218					
LSQCA2012 LSQPA2012				Inductance change : Within $\pm 35\%$	
LLQCA2012 LLQPA2012					
Test Methods and Remarks	Based on the inductance at 20°C and Measured at the ambient of $-40^{\circ}\text{C} \sim +85^{\circ}\text{C}$.				

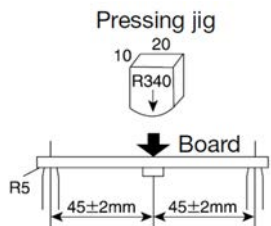
9.Rasistance to Flexure of Substrate	
Specified Value	No damage.
Test Methods and Remarks	<p>Warp : 2mm Test substrate : Glass epoxy-resin substrate Thickness : 1.0mm (1608 type:0.8mm)</p> <p>Pressing jig</p>  <p>Board</p> <p>45±2mm 45±2mm</p>

10.Body Strength	
Specified Value	No damage.
Test Methods and Remarks	<p>Applied force : 10N (1608 type :5N) Duration : 10sec.</p>

11.Adhesion of terminal electrode		
Specified Value	LB, LBC, LBR, LBMF Series	No abnormality.
	CB, CBC, CBL, CBMF Series	
	LBM Series	
Test Methods and Remarks	<p>Applied force : 10N to X and Y directions (1608 type :5N to X and Y directions) Duration : 5 sec. Test substrate : Printed board</p>	

12. Resistance to vibration

Specified Value	Wire-wound Ferrite Inductors, Wire-wound Ferrite Power Inductors Inductance change : Within $\pm 10\%$ No significant abnormality in appearance. Wire-wound Ferrite Inductors for Signal Lines Inductance change : Within $\pm 5\%$ No significant abnormality in appearance.														
Test Methods and Remarks	The given sample is soldered to the board and then it is tested depending on the conditions of the following table. <table border="1"> <tr> <td>Vibration Frequency</td> <td colspan="2">10~55Hz</td> </tr> <tr> <td>Total Amplitude</td> <td colspan="2">1.5mm (May not exceed acceleration 196m/s²)</td> </tr> <tr> <td>Sweeping Method</td> <td colspan="2">10Hz to 55Hz to 10Hz for 1min.</td> </tr> <tr> <td rowspan="3">Time</td> <td>X</td> <td rowspan="3">For 2 hours on each X, Y, and Z axis.</td> </tr> <tr> <td>Y</td> </tr> <tr> <td>Z</td> </tr> </table> Recovery : At least 2 hrs of recovery under the standard condition after the test, followed by the measurement within 48 hrs.	Vibration Frequency	10~55Hz		Total Amplitude	1.5mm (May not exceed acceleration 196m/s ²)		Sweeping Method	10Hz to 55Hz to 10Hz for 1min.		Time	X	For 2 hours on each X, Y, and Z axis.	Y	Z
Vibration Frequency	10~55Hz														
Total Amplitude	1.5mm (May not exceed acceleration 196m/s ²)														
Sweeping Method	10Hz to 55Hz to 10Hz for 1min.														
Time	X	For 2 hours on each X, Y, and Z axis.													
	Y														
	Z														

13. Drop test

Specified Value	—
-----------------	---

14. Solderability

Specified Value	At least 90% of surface of terminal electrode is covered by new
Test Methods and Remarks	Solder temperature : $245 \pm 5^\circ\text{C}$ Duration : $5 \pm 0.5\text{sec}$ Flux : Ethanol solution with 25% of colophony

15. Resistance to soldering

Specified Value	Wire-wound Ferrite Inductors, Wire-wound Ferrite Power Inductors Inductance change : Within $\pm 10\%$ Wire-wound Ferrite Inductors for Signal Lines Inductance change : Within $\pm 5\%$
Test Methods and Remarks	3 times of reflow oven at 230°C MIN for 40sec. with peak temperature at 260°C for 5sec. Recovery : At least 2 hrs of recovery under the standard condition after the test, followed by the measurement within 48 hrs.

16. Resistance to solvent

Specified Value	—
Test Methods and Remarks	Solvent temperature : Room temperature Type of solvent : Isopropyl alcohol Cleaning conditions : 90s. Immersion and cleaning.

17. Thermal shock

Specified Value	Inductance change : Within $\pm 10\%$ No significant abnormality in appearance.																		
Test Methods and Remarks	The given sample is soldered to the board and then its Inductance is measured after 100cycles of the following conditions. <table border="1"> <thead> <tr> <th colspan="3">Conditions of 1 cycle</th> </tr> <tr> <th>Step</th> <th>Temperature ($^\circ\text{C}$)</th> <th>Duration (min)</th> </tr> </thead> <tbody> <tr> <td>1</td> <td>-40 ± 3</td> <td>30 ± 3</td> </tr> <tr> <td>2</td> <td>Room temperature</td> <td>Within 3</td> </tr> <tr> <td>3</td> <td>$+85 \pm 2$</td> <td>30 ± 3</td> </tr> <tr> <td>4</td> <td>Room temperature</td> <td>Within 3</td> </tr> </tbody> </table> Recovery : At least 2 hrs of recovery under the standard condition after the test, followed by the measurement within 48 hrs.	Conditions of 1 cycle			Step	Temperature ($^\circ\text{C}$)	Duration (min)	1	-40 ± 3	30 ± 3	2	Room temperature	Within 3	3	$+85 \pm 2$	30 ± 3	4	Room temperature	Within 3
Conditions of 1 cycle																			
Step	Temperature ($^\circ\text{C}$)	Duration (min)																	
1	-40 ± 3	30 ± 3																	
2	Room temperature	Within 3																	
3	$+85 \pm 2$	30 ± 3																	
4	Room temperature	Within 3																	

18. Damp heat life test

Specified Value	Inductance change : Within $\pm 10\%$ No significant abnormality in appearance.
Test Methods and Remarks	Temperature : $60 \pm 2^\circ\text{C}$ Humidity : 90~95%RH Duration : 1000 hrs Recovery : At least 2 hrs of recovery under the standard condition after the test, followed by the measurement within 48 hrs.

19.Loading under damp heat life test	
Specified Value	Inductance change : Within $\pm 10\%$ No significant abnormality in appearance.
Test Methods and Remarks	Temperature : $60 \pm 2^\circ\text{C}$ Humidity : $90 \sim 95\% \text{RH}$ Duration : 1000 hrs Applied current : Rated current Recovery : At least 2 hrs of recovery under the standard condition after the test, followed by the measurement within 48 hrs.
20.High temperature life test	
Specified Value	Wire-wound Ferrite Power Inductors, Wire-wound Ferrite Inductors for Signal Lines : Inductance change : Within $\pm 10\%$ No significant abnormality in appearance.
Test Methods and Remarks	Temperature : $85 \pm 2^\circ\text{C}$ Duration : 1000 hrs Recovery : At least 2 hrs of recovery under the standard condition after the test, followed by the measurement within 48 hrs.
21.Loading at high temperature life test	
Specified Value	Wire-wound Ferrite Inductors : Inductance change : Within $\pm 10\%$ (3225 type : Within $\pm 20\%$) No significant abnormality in appearance.
Test Methods and Remarks	Temperature : $85 \pm 2^\circ\text{C}$ Duration : 1000 hrs Applied current : Rated current Recovery : At least 2 hrs of recovery under the standard condition after the test, followed by the measurement within 48 hrs.
22.Low temperature life test	
Specified Value	Inductance change : Within $\pm 10\%$ No significant abnormality in appearance.
Test Methods and Remarks	Temperature : $-40 \pm 2^\circ\text{C}$ Duration : 1000 hrs Recovery : At least 2 hrs of recovery under the standard condition after the test, followed by the measurement within 48 hrs.
23.Standard condition	
Specified Value	Standard test conditions Unless specified, Ambient temperature is $20 \pm 15^\circ\text{C}$ and the Relative humidity is $65 \pm 20\%$. If there is any doubt about the test results, further measurement shall be had within the following limits: Ambient Temperature: $20 \pm 2^\circ\text{C}$ Relative humidity: $65 \pm 5\%$ Inductance value is based on our standard measurement systems.

**Wire-wound Ferrite Inductors LSQB/LSQC/LSQE/LLQB/LLQC/LLQE/LMQB/LMQC/LMQE/
LBQB/LBQC/LBQE series**

**Wire-wound Ferrite Power Inductors LSQN/LSQPA/LLQN/LLQPA/LMQN/LMQPA/
LBQN/LBQPA series**

Wire-wound Ferrite Inductors for Signal Lines LSQM/LLQM/LMQM/LBQM series

■ PRECAUTIONS

1. Circuit Design	
Precautions	<ul style="list-style-type: none"> ◆ Verification of operating environment, electrical rating and performance <ol style="list-style-type: none"> 1. A malfunction in medical equipment, spacecraft, nuclear reactors, etc. may cause serious harm to human life or have severe social ramifications. As such, any inductors to be used in such equipment may require higher safety and/or reliability considerations and should be clearly differentiated from components used in general purpose applications. 2. When inductors are used in places where dew condensation develops and/or where corrosive gas such as hydrogen sulfide, sulfurous acid, or chlorine exists in the air, characteristic deterioration may occur. Please do not use inductors under such environmental conditions. ◆ Operating Current (Verification of Rated current) <ol style="list-style-type: none"> 1. The operating current including inrush current for inductors must always be lower than their rated values. 2. Do not apply current in excess of the rated value because the inductance may be reduced due to the magnetic saturation effect. ◆ Temperature rise <p>Temperature rise of power choke coil depends on the installation condition in end products.</p> <p>Make sure that temperature rise of power choke coils in actual end products is within the specified temperature range.</p>
2. PCB Design	
Precautions	<ul style="list-style-type: none"> ◆ Land pattern design <ol style="list-style-type: none"> 1. Please contact any of our offices for a land pattern, and refer to a recommended land pattern of a right figure or specifications.
Technical considerations	<p>PRECAUTIONS</p> <p>【Recommended Land Patterns】</p> <p>Surface Mounting</p> <ul style="list-style-type: none"> • Mounting and soldering conditions should be checked beforehand. • Applicable soldering process to those products is reflow soldering only.
3. Considerations for automatic placement	
Precautions	<ul style="list-style-type: none"> ◆ Adjustment of mounting machine <ol style="list-style-type: none"> 1. Excessive impact load should not be imposed on the products when mounting onto the PC boards. 2. Mounting and soldering conditions should be checked beforehand.
Technical considerations	<ol style="list-style-type: none"> 1. When installing products, care should be taken not to apply distortion stress as it may deform the products.
4. Soldering	
Precautions	<ul style="list-style-type: none"> ◆ Reflow soldering (Wire-wound Ferrite Inductors, Wire-wound Ferrite Power Inductors) <ol style="list-style-type: none"> 1. For reflow soldering with either leaded or lead-free solder, the profile specified in "point for controlling" is recommended. ◆ Recommended conditions for using a soldering iron <ol style="list-style-type: none"> 1. Put the soldering iron on the land-pattern. Soldering iron's temperature - Below 350°C Duration-3 seconds or less. The soldering iron should not come in contact with inductor directly.
Technical considerations	<ul style="list-style-type: none"> ◆ Reflow soldering (Wire-wound Ferrite Inductors, Wire-wound Ferrite Power Inductors) <ol style="list-style-type: none"> 1. Reflow profile <div style="text-align: center;"> <p>The graph shows a reflow profile with the following parameters:</p> <ul style="list-style-type: none"> Temperature range: 150~180°C Heating time to 150~180°C: 90±30sec Peak temperature: 260+0/-5°C Time at peak: 30±10sec Minimum peak temperature: 230°C min Cooling time: 5sec max </div> ◆ Recommended conditions for using a soldering iron <ol style="list-style-type: none"> 1. Components can be damaged by excessive heat where soldering conditions exceed the specified range.

▶ This catalog contains the typical specification only due to the limitation of space. When you consider the purchase of our products, please check our specification. For details of each product (characteristics graph, reliability information, precautions for use, and so on), see our Web site (<http://www.ty-top.com/>).

5. Cleaning

Precautions	<ul style="list-style-type: none">◆Cleaning conditions Washing by supersonic waves shall be avoided.
Technical considerations	<ul style="list-style-type: none">◆Cleaning conditions If washed by supersonic waves, the products might be broken.

6. Handling

Precautions	<ul style="list-style-type: none">◆Handling<ol style="list-style-type: none">1. Keep the inductors away from all magnets and magnetic objects.◆Breakaway PC boards (splitting along perforations)<ol style="list-style-type: none">1. When splitting the PC board after mounting inductors, care should be taken not to give any stresses of deflection or twisting to the board.2. Board separation should not be done manually, but by using the appropriate devices.◆Mechanical considerations<ol style="list-style-type: none">1. Please do not give the inductors any excessive mechanical shocks.
Technical considerations	<ul style="list-style-type: none">◆Handling<ol style="list-style-type: none">1. There is a case that a characteristic varies with magnetic influence.◆Breakaway PC boards (splitting along perforations)<ol style="list-style-type: none">1. Planning pattern configurations and the position of products should be carefully performed to minimize stress.◆Mechanical considerations<ol style="list-style-type: none">1. There is a case to be damaged by a mechanical shock.

7. Storage conditions

Precautions	<ul style="list-style-type: none">◆Storage<ol style="list-style-type: none">1. To maintain the solderability of terminal electrodes and to keep the packing material in good condition, temperature and humidity in the storage area should be controlled.<ul style="list-style-type: none">▪ Storage conditions Ambient temperature : 0~40°C Humidity : Below 70% RH▪ The recommended ambient temperature is below 30°C. Even under ideal storage conditions, solderability of products electrodes may decrease as time passes. For this reason, product should be used within 6 months from the time of delivery. In case of storage over 6 months, solderability shall be checked before actual usage.
Technical considerations	<ul style="list-style-type: none">◆Storage<ol style="list-style-type: none">1. Under a high temperature and humidity environment, problems such as reduced solderability caused by oxidation of terminal electrodes and deterioration of taping/packaging materials may take place.