

Notice for TAIYO YUDEN Products

Please read this notice before using the TAIYO YUDEN products.

REMINDERS

Product Information in this Catalog

Product information in this catalog is as of October 2021. All of the contents specified herein and production status of the products listed in this catalog are subject to change without notice due to technical improvement of our products, etc. Therefore, please check for the latest information carefully before practical application or use of our products.

Please note that TAIYO YUDEN shall not be in any way responsible for any damages and defects in products or equipment incorporating our products, which are caused under the conditions other than those specified in this catalog or individual product specification sheets.

Approval of Product Specifications

Please contact TAIYO YUDEN for further details of product specifications as the individual product specification sheets are available. When using our products, please be sure to approve our product specifications or make a written agreement on the product specification with TAIYO YUDEN in advance.

Pre-Evaluation in the Actual Equipment and Conditions

Please conduct validation and verification of our products in actual conditions of mounting and operating environment before using our products.

Safety Design

When using our products for high safety and/or reliability-required equipment or circuits, please fully perform safety and/or reliability evaluation. In addition, please install (i) systems equipped with a protection circuit and a protection device and/or (ii) systems equipped with a redundant circuit or other system to prevent an unsafe status in the event of a single fault for a failsafe design to ensure safety.

Intellectual Property Rights

Information contained in this catalog is intended to convey examples of typical performances and/or applications of our products and is not intended to make any warranty with respect to the intellectual property rights or any other related rights of TAIYO YUDEN or any third parties nor grant any license under such rights.

Limited Warranty

Please note that the scope of warranty for our products is limited to the delivered our products themselves conforming to the product specifications specified in the individual product specification sheets, and TAIYO YUDEN shall not be in any way responsible for any damages resulting from a failure or defect in our products. Notwithstanding the foregoing, if there is a written agreement (e.g., supply and purchase agreement, quality assurance agreement) signed by TAIYO YUDEN and your company, TAIYO YUDEN will warrant our products in accordance with such agreement, provided, however, that our products shall be used for general-purpose and standard use in the equipment specified in this catalog or the individual product specification sheets.

TAIYO YUDEN's Official Sales Channel

The contents of this catalog are applicable to our products which are purchased from our sales offices or authorized distributors (hereinafter "TAIYO YUDEN's official sales channel"). Please note that the contents of this catalog are not applicable to our products purchased from any seller other than TAIYO YUDEN's official sales channel.

Caution for Export

Some of our products listed in this catalog may require specific procedures for export according to "U.S. Export Administration Regulations", "Foreign Exchange and Foreign Trade Control Law" of Japan, and other applicable regulations. Should you have any questions on this matter, please contact our sales staff.

■ Limited Application

1. Equipment Intended for Use

The products listed in this catalog are intended for general-purpose and standard use in general electronic equipment for consumer (e.g., AV equipment, OA equipment, home electric appliances, office equipment, information and communication equipment including, without limitation, mobile phone, and PC) and other equipment specified in this catalog or the individual product specification sheets, or the equipment approved separately by TAIYO YUDEN.

TAIYO YUDEN has the product series intended for use in the following equipment. Therefore, when using our products for these equipment, please check available applications specified in this catalog or the individual product specification sheets and use the corresponding products.

Application	Product Series		Quality Grade ^{*3}
	Equipment ^{*1}	Category (Part Number Code ^{*2})	
Automotive	Automotive Electronic Equipment (POWERTRAIN, SAFETY)	A	1
	Automotive Electronic Equipment (BODY & CHASSIS, INFOTAINMENT)	C	2
Industrial	Telecommunications Infrastructure and Industrial Equipment	B	2
Medical	Medical Devices classified as GHTF Class C (Japan Class III)	M	2
	Medical Devices classified as GHTF Classes A or B (Japan Classes I or II)	L	3
Consumer	General Electronic Equipment	S	3

*Notes: 1. Based on the general specifications required for electronic components for such equipment, which are recognized by TAIYO YUDEN, the use of each product series for the equipment is recommended. Please be sure to contact TAIYO YUDEN before using our products for equipment other than those covered by the product series.

2. On each of our part number, the 2nd code from the left is a code indicating the "Category" as shown in the above table. For details, please check the explanatory materials regarding the part numbering system of each of our products.

3. Each product series is assigned a "Quality Grade" from 1 to 3 in order of higher quality. Please do not incorporate a product into any equipment with a higher Quality Grade than the Quality Grade of such product without the prior written consent of TAIYO YUDEN.

2. Equipment Requiring Inquiry

Please be sure to contact TAIYO YUDEN for further information before using the products listed in this catalog for the following equipment (excluding intended equipment as specified in this catalog or the individual product specification sheets) which may cause loss of human life, bodily injury, serious property damage and/or serious public impact due to a failure or defect of the products and/or malfunction attributed thereto.

- (1) Transportation equipment (automotive powertrain control system, train control system, and ship control system, etc.)
- (2) Traffic signal equipment
- (3) Disaster prevention equipment, crime prevention equipment
- (4) Medical devices classified as GHTF Class C (Japan Class III)
- (5) Highly public information network equipment, data-processing equipment (telephone exchange, and base station, etc.)
- (6) Any other equipment requiring high levels of quality and/or reliability equal to the equipment listed above

3. Equipment Prohibited for Use

Please do not incorporate our products into the following equipment requiring extremely high levels of safety and/or reliability.

- (1) Aerospace equipment (artificial satellite, rocket, etc.)
- (2) Aviation equipment ^{*1}
- (3) Medical devices classified as GHTF Class D (Japan Class IV), implantable medical devices ^{*2}
- (4) Power generation control equipment (nuclear power, hydroelectric power, thermal power plant control system, etc.)
- (5) Undersea equipment (submarine repeating equipment, etc.)
- (6) Military equipment
- (7) Any other equipment requiring extremely high levels of safety and/or reliability equal to the equipment listed above

*Notes: 1. There is a possibility that our products can be used only for aviation equipment that does not directly affect the safe operation of aircraft (e.g., in-flight entertainment, cabin light, electric seat, cooking equipment) if such use meets requirements specified separately by TAIYO YUDEN. Please be sure to contact TAIYO YUDEN for further information before using our products for such aviation equipment.

2. Implantable medical devices contain not only internal unit which is implanted in a body, but also external unit which is connected to the internal unit.

4. Limitation of Liability

Please note that unless you obtain prior written consent of TAIYO YUDEN, TAIYO YUDEN shall not be in any way responsible for any damages incurred by you or third parties arising from use of the products listed in this catalog for any equipment that is not intended for use by TAIYO YUDEN, or any equipment requiring inquiry to TAIYO YUDEN or prohibited for use by TAIYO YUDEN as described above.

Wire-wound Ferrite Power Inductors LSRN series for General Electronic Equipment for Consumer

Code in front of Series have been extracted from Part number, which describes the segment of products, such as kinds and characteristics.

REFLOW

PART NUMBER

* Operating Temp.: -40~+125°C (Including self-generated heat)

L	S	R	N	J	1	0	1	4	5	G	L	1	0	0	M	
①	②	③	④	⑤	⑥	⑦	⑧	⑨								

① Series

Code (1)(2)(3)(4)	
LSRN	Wire-wound Ferrite Power Inductor for General Electronic Equipment for Consumer

(1) Product Group

Code	
L	Inductors

(3) Type

Code	
R	Ferrite Wire-wound (Drum-sleeve, pedestal type)

(2) Category

Code	Recommended equipment	Quality Grade
S	General Electronic Equipment for Consumer	3

(4) Features, Characteristics

Code	
N	Standard Power choke

② Features

Code	Feature
J	Bottom electrode (Pedestal type)

⑥ Packaging

Code	Packaging
L	Taping

③ Dimensions (L × W)

Code	Dimensions (L × W) [mm]
101	10.1 × 10.1
125	12.5 × 12.5

⑦ Nominal inductance

Code (example)	Nominal inductance [μH]
1R0	1.0
100	10
101	100

※R=小数点

④ Dimensions (H)

Code	Dimensions (H) [mm]
45	4.5
55	5.5
65	6.5
75	7.5

⑧ Inductance tolerance

Code	Inductance tolerance
M	±20%
N	±30%

⑤ Operating temperature

Code	Operating temperature [°C]
G	-40~+125

⑨ Internal code

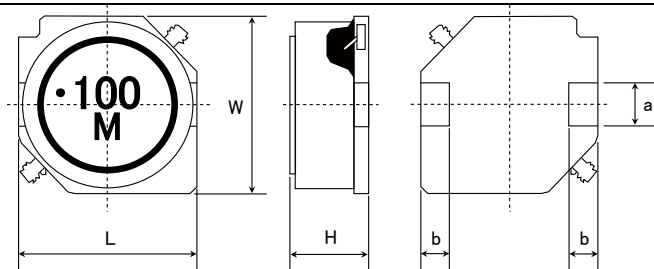
STANDARD EXTERNAL DIMENSIONS / MINIMUM QUANTITY

※101□□type does not have the indication of the Manufacturing date code.

Type	L	W	H	a	b	Minimum quantity [pcs]
10145	10.1±0.3 (0.398±0.012)	10.1±0.3 (0.398±0.012)	4.5±0.35 (0.177±0.014)	2.8±0.1 (0.110±0.004)	2.0±0.15 (0.079±0.006)	2000
10155	10.1±0.3 (0.398±0.012)	10.1±0.3 (0.398±0.012)	5.5±0.35 (0.217±0.014)	2.8±0.1 (0.110±0.004)	2.0±0.15 (0.079±0.006)	2000
10165	10.1±0.3 (0.398±0.012)	10.1±0.3 (0.398±0.012)	6.5±0.35 (0.256±0.014)	2.8±0.1 (0.110±0.004)	2.0±0.15 (0.079±0.006)	2000
12555	12.5±0.3 (0.492±0.012)	12.5±0.3 (0.492±0.012)	5.5±0.35 (0.217±0.014)	3.0±0.1 (0.118±0.004)	2.0±0.15 (0.079±0.006)	2000
12565	12.5±0.3 (0.492±0.012)	12.5±0.3 (0.492±0.012)	6.5±0.35 (0.256±0.014)	3.0±0.1 (0.118±0.004)	2.0±0.15 (0.079±0.006)	2000
12575	12.5±0.3 (0.492±0.012)	12.5±0.3 (0.492±0.012)	7.5±0.35 (0.295±0.014)	3.0±0.1 (0.118±0.004)	2.0±0.15 (0.079±0.006)	2000

Unit: mm (inch)

Recommended Land Patterns
Surface Mounting

- Mounting and soldering conditions should be checked beforehand.
- Applicable soldering process to these products is reflow soldering only.

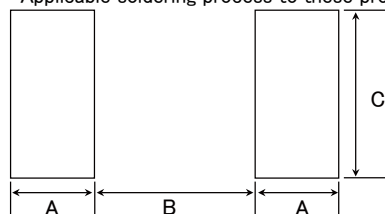

Type	A	B	C
10145	2.5	5.6	3.2
10155	2.5	5.6	3.2
10165	2.5	5.6	3.2
12555	2.5	8.6	3.2
12565	2.5	8.6	3.2
12575	2.5	8.6	3.2

Unit: mm

PART NUMBER

● 10145 type								
New part number	Old part number (for reference)	EHS	Nominal inductance [μ H]	Inductance tolerance	DC Resistance [Ω]($\pm 20\%$)	Rated current ※) [A]		Measuring frequency [kHz]
						Saturation current Idc1	Temperature rise current Idc2	
LSRNJ10145GL1R0NMY	NS 10145T 1R0NNA	RoHS	1.0	$\pm 30\%$	0.0049	12.54	8.90	100
LSRNJ10145GL1R5NMY	NS 10145T 1R5NNA	RoHS	1.5	$\pm 30\%$	0.0060	10.34	7.99	100
LSRNJ10145GL2R2NMY	NS 10145T 2R2NNA	RoHS	2.2	$\pm 30\%$	0.0085	8.91	6.64	100
LSRNJ10145GL3R3NMY	NS 10145T 3R3NNA	RoHS	3.3	$\pm 30\%$	0.0100	7.33	6.10	100
LSRNJ10145GL4R7NMY	NS 10145T 4R7NNA	RoHS	4.7	$\pm 30\%$	0.0144	6.69	5.03	100
LSRNJ10145GL5R6NMY	NS 10145T 5R6NNA	RoHS	5.6	$\pm 30\%$	0.0181	5.85	4.45	100
LSRNJ10145GL6R8NMY	NS 10145T 6R8NNA	RoHS	6.8	$\pm 30\%$	0.0200	5.05	4.22	100
LSRNJ10145GL100MNY	NS 10145T 100MNA	RoHS	10	$\pm 20\%$	0.0248	4.22	3.77	100
LSRNJ10145GL150MNY	NS 10145T 150MNA	RoHS	15	$\pm 20\%$	0.0381	3.44	3.00	100
LSRNJ10145GL220MNY	NS 10145T 220MNA	RoHS	22	$\pm 20\%$	0.0520	2.87	2.55	100
LSRNJ10145GL330MNY	NS 10145T 330MNA	RoHS	33	$\pm 20\%$	0.0815	2.36	2.01	100
LSRNJ10145GL470MNY	NS 10145T 470MNA	RoHS	47	$\pm 20\%$	0.100	1.85	1.80	100
LSRNJ10145GL680MNY	NS 10145T 680MNA	RoHS	68	$\pm 20\%$	0.150	1.66	1.45	100
LSRNJ10145GL101MNY	NS 10145T 101MNA	RoHS	100	$\pm 20\%$	0.200	1.29	1.25	100
LSRNJ10145GL151MNY	NS 10145T 151MNA	RoHS	150	$\pm 20\%$	0.341	1.11	0.94	100
LSRNJ10145GL221MNY	NS 10145T 221MNA	RoHS	220	$\pm 20\%$	0.485	0.91	0.78	100
LSRNJ10145GL331MNY	NS 10145T 331MNA	RoHS	330	$\pm 20\%$	0.700	0.71	0.64	100
LSRNJ10145GL471MNY	NS 10145T 471MNA	RoHS	470	$\pm 20\%$	1.030	0.61	0.52	100
LSRNJ10145GL681MNY	NS 10145T 681MNA	RoHS	680	$\pm 20\%$	1.57	0.50	0.42	100
LSRNJ10145GL102MNY	NS 10145T 102MNA	RoHS	1000	$\pm 20\%$	2.58	0.41	0.32	100
LSRNJ10145GL152MNY	NS 10145T 152MNA	RoHS	1500	$\pm 20\%$	3.70	0.36	0.27	100

● 10155 type								
New part number	Old part number (for reference)	EHS	Nominal inductance [μ H]	Inductance tolerance	DC Resistance [Ω]($\pm 20\%$)	Rated current ※) [A]		Measuring frequency [kHz]
						Saturation current Idc1	Temperature rise current Idc2	
LSRNJ10155GL1R5NMY	NS 10155T 1R5NNA	RoHS	1.5	$\pm 30\%$	0.0060	11.90	8.39	100
LSRNJ10155GL2R2NMY	NS 10155T 2R2NNA	RoHS	2.2	$\pm 30\%$	0.0072	10.00	7.61	100
LSRNJ10155GL3R3NMY	NS 10155T 3R3NNA	RoHS	3.3	$\pm 30\%$	0.0097	8.50	6.49	100
LSRNJ10155GL4R7NMY	NS 10155T 4R7NNA	RoHS	4.7	$\pm 30\%$	0.0112	7.40	6.01	100
LSRNJ10155GL6R8NMY	NS 10155T 6R8NNA	RoHS	6.8	$\pm 30\%$	0.0159	6.00	4.98	100
LSRNJ10155GL100MNY	NS 10155T 100MNA	RoHS	10	$\pm 20\%$	0.0200	4.49	4.40	100
LSRNJ10155GL150MNY	NS 10155T 150MNA	RoHS	15	$\pm 20\%$	0.0284	4.03	3.65	100
LSRNJ10155GL220MNY	NS 10155T 220MNA	RoHS	22	$\pm 20\%$	0.0380	3.37	3.12	100

● 10165 type								
New part number	Old part number (for reference)	EHS	Nominal inductance [μ H]	Inductance tolerance	DC Resistance [Ω]($\pm 20\%$)	Rated current ※) [A]		Measuring frequency [kHz]
						Saturation current Idc1	Temperature rise current Idc2	
LSRNJ10165GL1R5NMY	NS 10165T 1R5NNA	RoHS	1.5	$\pm 30\%$	0.0062	13.60	8.04	100
LSRNJ10165GL2R2NMY	NS 10165T 2R2NNA	RoHS	2.2	$\pm 30\%$	0.0074	10.80	7.32	100
LSRNJ10165GL3R3NMY	NS 10165T 3R3NNA	RoHS	3.3	$\pm 30\%$	0.0086	9.30	6.76	100
LSRNJ10165GL4R7NMY	NS 10165T 4R7NNA	RoHS	4.7	$\pm 30\%$	0.0112	7.70	5.88	100
LSRNJ10165GL6R8NMY	NS 10165T 6R8NNA	RoHS	6.8	$\pm 30\%$	0.0140	6.00	5.22	100
LSRNJ10165GL100MNY	NS 10165T 100MNA	RoHS	10	$\pm 20\%$	0.0174	5.20	4.66	100
LSRNJ10165GL150MNY	NS 10165T 150MNA	RoHS	15	$\pm 20\%$	0.0250	4.50	3.84	100
LSRNJ10165GL220MNY	NS 10165T 220MNA	RoHS	22	$\pm 20\%$	0.0313	3.60	3.41	100

● 12555 type								
New part number	Old part number (for reference)	EHS	Nominal inductance [μ H]	Inductance tolerance	DC Resistance [Ω]($\pm 20\%$)	Rated current ※) [A]		Measuring frequency [kHz]
						Saturation current Idc1	Temperature rise current Idc2	
LSRNJ12555GL6R0NMY	NS 12555T 6R0NN	RoHS	6.0	$\pm 30\%$	0.0140	5.01	5.60	100
LSRNJ12555GL100MNY	NS 12555T 100MN	RoHS	10	$\pm 20\%$	0.0175	4.73	5.04	100
LSRNJ12555GL150MNY	NS 12555T 150MN	RoHS	15	$\pm 20\%$	0.0233	3.89	4.18	100
LSRNJ12555GL220MNY	NS 12555T 220MN	RoHS	22	$\pm 20\%$	0.0297	3.20	3.81	100
LSRNJ12555GL330MNY	NS 12555T 330MN	RoHS	33	$\pm 20\%$	0.0415	2.64	3.16	100
LSRNJ12555GL470MNY	NS 12555T 470MN	RoHS	47	$\pm 20\%$	0.0551	2.23	2.70	100
LSRNJ12555GL680MNY	NS 12555T 680MN	RoHS	68	$\pm 20\%$	0.0797	1.81	2.14	100
LSRNJ12555GL101MNY	NS 12555T 101MN	RoHS	100	$\pm 20\%$	0.117	1.53	1.86	100
LSRNJ12555GL151MNY	NS 12555T 151MN	RoHS	150	$\pm 20\%$	0.176	1.22	1.43	100
LSRNJ12555GL221MNY	NS 12555T 221MN	RoHS	220	$\pm 20\%$	0.270	1.00	1.18	100
LSRNJ12555GL331MNY	NS 12555T 331MN	RoHS	330	$\pm 20\%$	0.410	0.82	0.96	100
LSRNJ12555GL471MNY	NS 12555T 471MN	RoHS	470	$\pm 20\%$	0.520	0.68	0.80	100
LSRNJ12555GL681MNY	NS 12555T 681MN	RoHS	680	$\pm 20\%$	0.760	0.60	0.72	100
LSRNJ12555GL102MNY	NS 12555T 102MN	RoHS	1000	$\pm 20\%$	1.12	0.47	0.59	100
LSRNJ12555GL152MNY	NS 12555T 152MN	RoHS	1500	$\pm 20\%$	1.73	0.40	0.44	100

※) The saturation current value (Idc1) is the DC current value having inductance decrease down to 30%. (at 20°C)

※) The temperature rise current value (Idc2) is the DC current value having temperature increase up to 40°C. (at 20°C)

※) The rated current is the DC current value that satisfies both of current value saturation current value and temperature rise current value.

PART NUMBER

● 12565 type								
New part number	Old part number (for reference)	EHS	Nominal inductance [μ H]	Inductance tolerance	DC Resistance [Ω]($\pm 20\%$)	Rated current ※) [A]		Measuring frequency [kHz]
						Saturation current Idc1	Temperature rise current Idc2	
LSRNJ12565GL2R0NMY	NS 12565T 2R0NN	RoHS	2.0	$\pm 30\%$	0.0080	13.91	7.60	100
LSRNJ12565GL4R2NMY	NS 12565T 4R2NN	RoHS	4.2	$\pm 30\%$	0.0126	10.15	5.91	100
LSRNJ12565GL7R0NMY	NS 12565T 7R0NN	RoHS	7.0	$\pm 30\%$	0.0162	7.93	5.21	100
LSRNJ12565GL100MMY	NS 12565T 100MN	RoHS	10	$\pm 20\%$	0.0199	6.96	4.75	100
LSRNJ12565GL150MMY	NS 12565T 150MN	RoHS	15	$\pm 20\%$	0.0237	5.84	4.33	100
LSRNJ12565GL220MMY	NS 12565T 220MN	RoHS	22	$\pm 20\%$	0.0310	4.87	3.91	100
LSRNJ12565GL330MMY	NS 12565T 330MN	RoHS	33	$\pm 20\%$	0.0390	3.89	3.22	100
LSRNJ12565GL470MMY	NS 12565T 470MN	RoHS	47	$\pm 20\%$	0.0575	3.34	2.78	100
LSRNJ12565GL680MMY	NS 12565T 680MN	RoHS	68	$\pm 20\%$	0.0775	2.78	2.30	100
LSRNJ12565GL101IMMY	NS 12565T 101MN	RoHS	100	$\pm 20\%$	0.123	2.23	1.81	100
LSRNJ12565GL151IMMY	NS 12565T 151MN	RoHS	150	$\pm 20\%$	0.173	1.84	1.54	100
LSRNJ12565GL221IMMY	NS 12565T 221MN	RoHS	220	$\pm 20\%$	0.273	1.39	1.18	100

● 12575 type								
New part number	Old part number (for reference)	EHS	Nominal inductance [μ H]	Inductance tolerance	DC Resistance [Ω]($\pm 20\%$)	Rated current ※) [A]		Measuring frequency [kHz]
						Saturation current Idc1	Temperature rise current Idc2	
LSRNJ12575GL1R2NMY	NS 12575T 1R2NN	RoHS	1.2	$\pm 30\%$	0.0058	18.08	9.15	100
LSRNJ12575GL2R7NMY	NS 12575T 2R7NN	RoHS	2.7	$\pm 30\%$	0.0085	13.91	7.69	100
LSRNJ12575GL3R9NMY	NS 12575T 3R9NN	RoHS	3.9	$\pm 30\%$	0.0099	12.52	7.38	100
LSRNJ12575GL5R6NMY	NS 12575T 5R6NN	RoHS	5.6	$\pm 30\%$	0.0116	10.85	6.36	100
LSRNJ12575GL6R8NMY	NS 12575T 6R8NN	RoHS	6.8	$\pm 30\%$	0.0131	10.02	5.84	100
LSRNJ12575GL100MMY	NS 12575T 100MN	RoHS	10	$\pm 20\%$	0.0156	7.65	5.55	100
LSRNJ12575GL150MMY	NS 12575T 150MN	RoHS	15	$\pm 20\%$	0.0184	6.54	5.22	100
LSRNJ12575GL220MMY	NS 12575T 220MN	RoHS	22	$\pm 20\%$	0.0260	5.56	4.05	100
LSRNJ12575GL330MMY	NS 12575T 330MN	RoHS	33	$\pm 20\%$	0.0390	4.45	3.48	100
LSRNJ12575GL470MMY	NS 12575T 470MN	RoHS	47	$\pm 20\%$	0.0515	3.76	2.95	100
LSRNJ12575GL680MMY	NS 12575T 680MN	RoHS	68	$\pm 20\%$	0.0720	2.78	2.49	100
LSRNJ12575GL101IMMY	NS 12575T 101MN	RoHS	100	$\pm 20\%$	0.110	2.64	2.01	100
LSRNJ12575GL151IMMY	NS 12575T 151MN	RoHS	150	$\pm 20\%$	0.161	2.09	1.51	100
LSRNJ12575GL221IMMY	NS 12575T 221MN	RoHS	220	$\pm 20\%$	0.245	1.81	1.35	100

※) The saturation current value (Idc1) is the DC current value having inductance decrease down to 30%. (at 20°C)

※) The temperature rise current value (Idc2) is the DC current value having temperature increase up to 40°C. (at 20°C)

※) The rated current is the DC current value that satisfies both of current value saturation current value and temperature rise current value.

Wire-wound Ferrite Power Inductors LSRN/LCRN/LBRN/LLRN/LMRN series

PACKAGING

① Packing Quantity

Type	Standard Quantity (1reel) [pcs]	Minimum Quantity [pcs]
	Embossed Tape	Embossed Tape
10145	500	2000
10155	500	2000
10165	500	2000
12555	500	2000
12565	500	2000
12575	500	2000

② Tape Material

● Embossed Tape

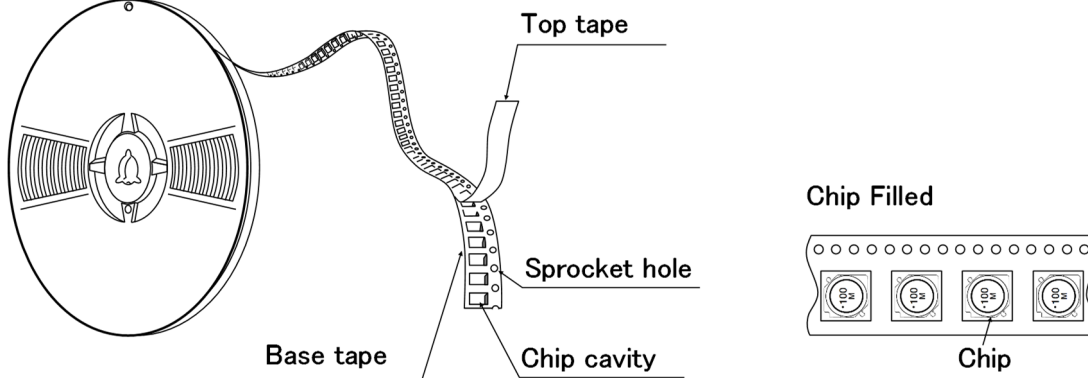

③ Taping dimensions

● Embossed tape 24mm wide (0.945 inches wide)

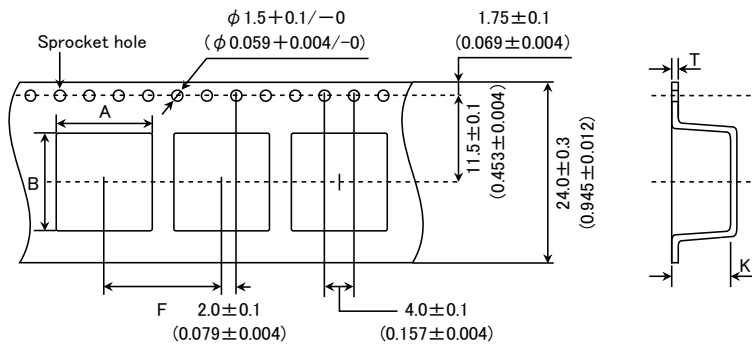

Type	Chip cavity		Insertion pitch	Tape thickness	
	A	B	F	T	K
10145	10.5 ± 0.1 (0.413 ± 0.004)	10.5 ± 0.1 (0.413 ± 0.004)	16.0 ± 0.1 (0.630 ± 0.004)	0.4 ± 0.1 (0.016 ± 0.004)	5.0 ± 0.1 (0.197 ± 0.004)
10155	10.5 ± 0.1 (0.413 ± 0.004)	10.5 ± 0.1 (0.413 ± 0.004)	16.0 ± 0.1 (0.630 ± 0.004)	0.4 ± 0.1 (0.016 ± 0.004)	6.0 ± 0.1 (0.236 ± 0.004)
10165	10.5 ± 0.1 (0.413 ± 0.004)	10.5 ± 0.1 (0.413 ± 0.004)	16.0 ± 0.1 (0.630 ± 0.004)	0.4 ± 0.1 (0.016 ± 0.004)	7.0 ± 0.1 (0.276 ± 0.004)
12555	13.0 ± 0.1 (0.512 ± 0.004)	13.0 ± 0.1 (0.512 ± 0.004)	16.0 ± 0.1 (0.630 ± 0.004)	0.4 ± 0.1 (0.016 ± 0.004)	6.1 ± 0.1 (0.240 ± 0.004)
12565	13.0 ± 0.1 (0.512 ± 0.004)	13.0 ± 0.1 (0.512 ± 0.004)	16.0 ± 0.1 (0.630 ± 0.004)	0.4 ± 0.1 (0.016 ± 0.004)	7.1 ± 0.1 (0.280 ± 0.004)
12575	13.0 ± 0.1 (0.512 ± 0.004)	13.0 ± 0.1 (0.512 ± 0.004)	16.0 ± 0.1 (0.630 ± 0.004)	0.4 ± 0.1 (0.016 ± 0.004)	8.0 ± 0.1 (0.315 ± 0.004)

Unit : mm (inch)

► This catalog contains the typical specification only due to the limitation of space. When you consider the purchase of our products, please check our specification. For details of each product (characteristics graph, reliability information, precautions for use, and so on), see our Web site (<http://www.ty-top.com/>).

④ Leader and Blank portion

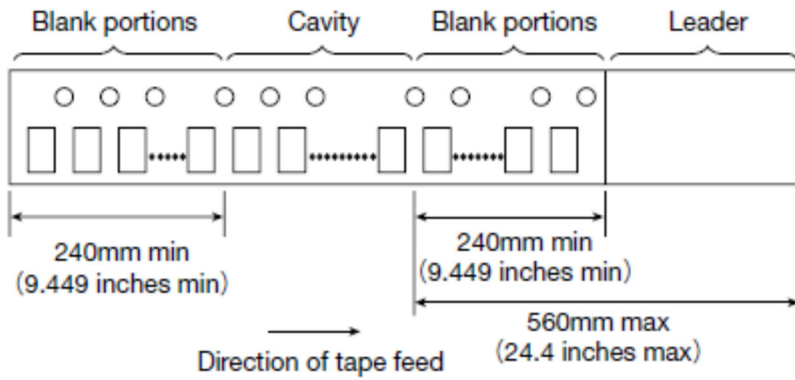

⑤ Reel size

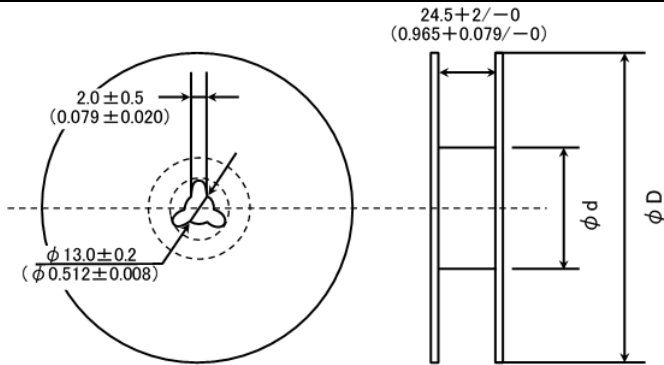

Type	Reel size (Reference values)	
	ϕD	ϕd
10145	330 ± 2 (12.99 ± 0.079)	100 ± 1 (3.937 ± 0.039)
10155		
10165		
12555		
12565		
12575		

Unit: mm (inch)

⑥ Top Tape Strength

The top tape requires a peel-off force of 0.1 to 1.3N in the direction of the arrow as illustrated below.

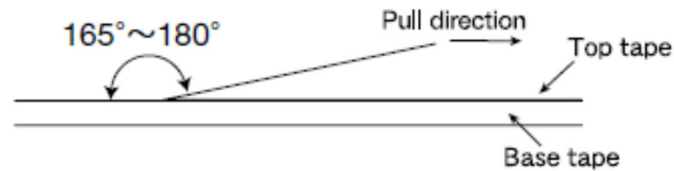

Wire-wound Ferrite Power Inductors LSRN series for General Electronic Equipment for Consumer
 Wire-wound Ferrite Power Inductors LLRN series
 for Medical Devices classified as GHTF Classes A or B (Japan Classes I or II)

■ RELIABILITY DATA

1. Operating Temperature Range													
Specified Value	-40~+125°C												
Test Methods and Remarks	Including self-generated heat												
2. Storage Temperature Range													
Specified Value	-40~+85°C												
Test Methods and Remarks	-5 to 40°C for the product with taping.												
3. Rated current													
Specified Value	Within the specified tolerance												
4. Inductance													
Specified Value	Within the specified tolerance												
Test Methods and Remarks	Measuring equipment : LCR Meter (HP 4285A or equivalent) Measuring frequency : 100kHz, 1V												
5. DC Resistance													
Specified Value	Within the specified tolerance												
Test Methods and Remarks	Measuring equipment : DC ohmmeter (HIOKI 3227 or equivalent)												
6. Self resonance frequency													
Specified Value	—												
7. Temperature characteristic													
Specified Value	Inductance change : Within $\pm 15\%$												
Test Methods and Remarks	<p>Measurement of inductance shall be taken at temperature range within $-40^{\circ}\text{C}\sim +125^{\circ}\text{C}$. With reference to inductance value at $+20^{\circ}\text{C}$., change rate shall be calculated. Change of maximum inductance deviation in step 1 to 5</p> <table border="1"> <thead> <tr> <th>Step</th> <th>Temperature (°C)</th> </tr> </thead> <tbody> <tr> <td>1</td> <td>20</td> </tr> <tr> <td>2</td> <td>Minimum operating temperature</td> </tr> <tr> <td>3</td> <td>20 (Standard temperature)</td> </tr> <tr> <td>4</td> <td>Maximum operating temperature</td> </tr> <tr> <td>5</td> <td>20</td> </tr> </tbody> </table>	Step	Temperature (°C)	1	20	2	Minimum operating temperature	3	20 (Standard temperature)	4	Maximum operating temperature	5	20
Step	Temperature (°C)												
1	20												
2	Minimum operating temperature												
3	20 (Standard temperature)												
4	Maximum operating temperature												
5	20												

► This catalog contains the typical specification only due to the limitation of space. When you consider the purchase of our products, please check our specification.
 For details of each product (characteristics graph, reliability information, precautions for use, and so on), see our Web site (<http://www.ty-top.com/>).

8. Resistance to flexure of substrate

Specified Value	No damage														
Test Methods and Remarks	The test samples shall be soldered to the test board by the reflow. As illustrated below, apply force in the direction of the arrow indicating until deflection of the test board reaches to 2 mm. Test board size : 100 × 40 × 1.0 Test board material : Glass epoxy-resin Solder cream thickness : 0.15mm														
	Land dimension	<table border="1"> <thead> <tr> <th>Type</th> <th>A</th> <th>B</th> <th>C</th> </tr> </thead> <tbody> <tr> <td>101</td> <td>2.5</td> <td>5.6</td> <td>3.2</td> </tr> <tr> <td>125</td> <td>2.5</td> <td>8.6</td> <td>3.2</td> </tr> </tbody> </table>			Type	A	B	C	101	2.5	5.6	3.2	125	2.5	8.6
Type	A	B	C												
101	2.5	5.6	3.2												
125	2.5	8.6	3.2												

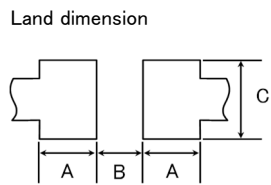

9. Insulation resistance : between wires

Specified Value	—
-----------------	---

10. Insulation resistance : between wire and core

Specified Value	—
-----------------	---

11. Withstanding voltage : between wire and core

Specified Value	—
-----------------	---

12. Adhesion of terminal electrode

Specified Value	Shall not come off PC board
Test Methods and Remarks	The test samples shall be soldered to the test board by the reflow. Applied force : 10N to X and Y directions. Duration : 5s. Solder cream thickness : 0.15mm

13. Resistance to vibration

Specified Value	Inductance change : Within ±10% No significant abnormality in appearance.		
Test Methods and Remarks	The test samples shall be soldered to the test board by the reflow. Then it shall be submitted to below test conditions.		
	Frequency Range	10~55Hz	
	Total Amplitude	1.5mm (May not exceed acceleration 196m/s ²)	
	Sweeping Method	10Hz to 55Hz to 10Hz for 1min.	
Time	X	For 2 hours on each X, Y, and Z axis.	
	Y		
	Z		
Recovery : At least 2hrs of recovery under the standard condition after the test, followed by the measurement within 48hrs.			

▶ This catalog contains the typical specification only due to the limitation of space. When you consider the purchase of our products, please check our specification. For details of each product (characteristics graph, reliability information, precautions for use, and so on), see our Web site (<http://www.ty-top.com/>).

14. Solderability

Specified Value	At least 90% of surface of terminal electrode is covered by new solder.	
Test Methods and Remarks	The test samples shall be dipped in flux, and then immersed in molten solder as shown in below table. Flux : Ethanol solution containing rosin 25%.	
	Solder Temperature	245±5°C
	Time	5±1.0 sec.
※Immersion depth : All sides of mounting terminal shall be immersed.		

15. Resistance to soldering heat

Specified Value	Inductance change : Within ±10% No significant abnormality in appearance.	
Test Methods and Remarks	The test sample shall be exposed to reflow oven at 230±5°C for 40 seconds, with peak temperature at 260±5°C for 5 seconds, 2 times.	
	Test board material	: Glass epoxy-resin
	Test board thickness	: 1.0mm

16. Thermal shock

Specified Value	Inductance change : Within ±10% No significant abnormality in appearance.		
Test Methods and Remarks	The test samples shall be soldered to the test board by the reflow. The test samples shall be placed at specified temperature for specified time by step 1 to step 4 as shown in below table in sequence. The temperature cycle shall be repeated 100 cycles.		
	Conditions of 1 cycle		
	Step	Temperature (°C)	Duration (min)
	1	-40±3	30±3
	2	Room temperature	Within 3
3	+85±2	30±3	
4	Room temperature	Within 3	
Recovery : At least 2hrs of recovery under the standard condition after the test, followed by the measurement within 48hrs.			

17. Damp heat

Specified Value	Inductance change : Within ±10% No significant abnormality in appearance.	
Test Methods and Remarks	The test samples shall be soldered to the test board by the reflow. The test samples shall be placed in thermostatic oven set at specified temperature and humidity as shown in below table.	
	Temperature	60±2°C
	Humidity	90~95%RH
	Time	500+24/-0 hour
Recovery : At least 2hrs of recovery under the standard condition after the test, followed by the measurement within 48hrs.		

18. Loading under damp heat

Specified Value	Inductance change : Within ±10% No significant abnormality in appearance.	
Test Methods and Remarks	The test samples shall be soldered to the test board by the reflow. The test samples shall be placed in thermostatic oven set at specified temperature and humidity and applied the rated current continuously as shown in below table.	
	Temperature	60±2°C
	Humidity	90~95%RH
	Applied current	Rated current
	Time	500+24/-0 hour
Recovery : At least 2hrs of recovery under the standard condition after the test, followed by the measurement within 48hrs.		

19. Low temperature life test

Specified Value	Inductance change : Within ±10% No significant abnormality in appearance.	
Test Methods and Remarks	The test samples shall be soldered to the test board by the reflow. After that, the test samples shall be placed at test conditions as shown in below table.	
	Temperature	-40±2°C
	Time	500+24/-0 hour
Recovery : At least 2hrs of recovery under the standard condition after the test, followed by the measurement within 48hrs.		

▶ This catalog contains the typical specification only due to the limitation of space. When you consider the purchase of our products, please check our specification.
For details of each product (characteristics graph, reliability information, precautions for use, and so on), see our Web site (<http://www.ty-top.com/>).

20. High temperature life test

Specified Value	—
-----------------	---

21. Loading at high temperature life test

Specified Value	Inductance change : Within $\pm 10\%$ No significant abnormality in appearance.	
Test Methods and Remarks	The test samples shall be soldered to the test board by the reflow soldering.	
	Temperature	$85 \pm 2^\circ\text{C}$
	Applied current	Rated current
	Time	$500 + 24 / - 0$ hour
	Recovery : At least 2hrs of recovery under the standard condition after the test, followed by the measurement within 48hrs.	

22. Standard condition

Specified Value	Standard test condition : Unless otherwise specified, temperature is $20 \pm 15^\circ\text{C}$ and $65 \pm 20\%$ of relative humidity. When there is any question concerning measurement result: In order to provide correlation data, the test shall be condition of $20 \pm 2^\circ\text{C}$ of temperature, $65 \pm 5\%$ relative humidity. Inductance is in accordance with our measured value.
-----------------	--

Wire-wound Ferrite Power Inductors LSXB/LSXN/LSXP series

for General Electronic Equipment for Consumer

Wire-wound Ferrite Power Inductors LSXBH10050 for General Electronic Equipment for Consumer

Wire-wound Ferrite Power Inductors LSRN series for General Electronic Equipment for Consumer

Wire-wound Ferrite Power Inductors LLXB/LLXN/LLXP series

for Medical Devices classified as GHTF Classes A or B (Japan Classes I or II)

Wire-wound Ferrite Power Inductors LLXBH10050

for Medical Devices classified as GHTF Classes A or B (Japan Classes I or II)

Wire-wound Ferrite Power Inductors LLRN series

for Medical Devices classified as GHTF Classes A or B (Japan Classes I or II)

■ PRECAUTIONS

1. Circuit Design

Precautions	<ul style="list-style-type: none"> ◆ Verification of operating environment, electrical rating and performance <ol style="list-style-type: none"> 1. A malfunction in medical equipment, spacecraft, nuclear reactors, etc. may cause serious harm to human life or have severe social ramifications. As such, any inductors to be used in such equipment may require higher safety and/or reliability considerations and should be clearly differentiated from components used in general purpose applications. 2. When inductors are used in places where dew condensation develops and/or where corrosive gas such as hydrogen sulfide, sulfurous acid, or chlorine exists in the air, characteristic deterioration may occur. Please do not use inductors under such environmental conditions. ◆ Operating Current (Verification of Rated current) <ol style="list-style-type: none"> 1. The operating current including inrush current for inductors must always be lower than their rated values. 2. Do not apply current in excess of the rated value because the inductance may be reduced due to the magnetic saturation effect. ◆ Temperature rise <p>Temperature rise of power choke coil depends on the installation condition in end products.</p> <p>Make sure that temperature rise of power choke coils in actual end products is within the specified temperature range.</p>
-------------	--

2. PCB Design

Precautions	<ul style="list-style-type: none"> ◆ Land pattern design <ol style="list-style-type: none"> 1. Please refer to a recommended land pattern. 2. There is stress, which has been caused by distortion of a PCB, to the inductor. (LSXB/LSXN/LSXP/LLXB/LLXN/LLXP) 3. Please consider the arrangement of parts on a PCB. (LSXB/LSXN/LSXP/LLXB/LLXN/LLXP)
Technical considerations	<ul style="list-style-type: none"> ◆ Land pattern design <p>Surface Mounting</p> <ol style="list-style-type: none"> 1. Mounting and soldering conditions should be checked beforehand. 2. Applicable soldering process to this products is reflow soldering only. 3. Please use the recommended land pattern shown as below. Electrical characteristics and the mounting ability of the product are being considered in the recommended land pattern. If a PCB is designed with other dimensions, defective soldering and stress to a product may occur due to misalignment. The performance of the product may not be brought out. If an adopted land pattern is different from the recommended land pattern, stress to the product will increase. It may cause cracks or defective electrical characteristics of the product. Please conduct validation completely before studying adoption of this product and please judge the pros and cons of adoption of this product with taking on responsibility. (LSXB/LSXN/LSXP/LLXB/LLXN/LLXP) 4. As coefficients of thermal expansion between an inductor and a PCB differs, cracks may occur on a ferrite core when thermal stress is applied to them after mounting an inductor. (Please refer to the drawings below.) Please conduct validation completely before studying adoption of this product and please judge the pros and cons of adoption of this product with taking on responsibility. (LSXB/LSXN/LSXP/LLXB/LLXN/LLXP)

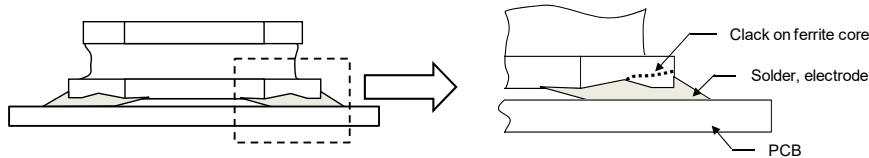

► This catalog contains the typical specification only due to the limitation of space. When you consider the purchase of our products, please check our specification. For details of each product (characteristics graph, reliability information, precautions for use, and so on), see our Web site (<http://www.ty-top.com/>)

5. SMD inductors should be located to minimize any possible mechanical stresses from board warp or deflection. When splitting the PC board after mounting inductors and other components, care is required so as not to give any stresses of deflection or twisting to the board. (LSXB/LSXN/LSXP/LLXB/LLXN/LLXP)

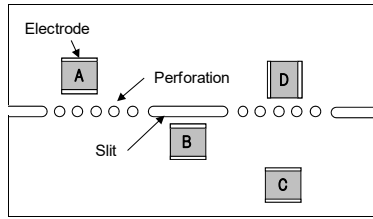

A product tends to undergo stress in order “A>C>B≡D”. Please consider the layouts of a product to minimize any stresses.

3. Considerations for automatic placement

Precautions	<ul style="list-style-type: none"> ◆ Adjustment of mounting machine 1. Excessive impact load should not be imposed on the products when mounting onto the PC boards. 2. Mounting and soldering conditions should be checked beforehand.
Technical considerations	<ul style="list-style-type: none"> ◆ Adjustment of mounting machine 1. When installing products, care should be taken not to apply distortion stress as it may deform the products. 2. Stress may be applied to a product with a warp or a twist in handling of the product. Please conduct validation completely before studying adoption of this product and please judge the pros and cons of adoption of this product with taking on responsibility. (LSXB/LSXN/LSXP/LLXB/LLXN/LLXP) <div style="display: flex; justify-content: space-around; align-items: center;"> <div style="text-align: center;"> <p><Wrap></p> </div> <div style="text-align: center;"> <p><Twist></p> </div> </div>

4. Soldering

Precautions	<ul style="list-style-type: none"> ◆ Reflow soldering 1. Please contact any of our offices for a reflow soldering, and refer to the recommended condition specified. 2. The product shall be used reflow soldering only. 3. Please do not add any stress to a product until it returns in normal temperature after reflow soldering. ◆ Lead free soldering 1. When using products with lead free soldering, we request to use them after confirming adhesion, temperature of resistance to soldering heat, soldering etc sufficiently. ◆ Recommended conditions for using a soldering iron (LSXBH10050/LLXBH10050) <ul style="list-style-type: none"> • Put the soldering iron on the land-pattern. • Soldering iron's temperature - Below 350°C • Duration - 3 seconds or less • The soldering iron should not directly touch the inductor.
Technical considerations	<ul style="list-style-type: none"> ◆ Reflow soldering 1. If products are used beyond the range of the recommended conditions, heat stresses may deform the products, and consequently degrade the reliability of the products. <p style="text-align: center;">Recommended reflow condition (Pb free solder)</p>

5. Cleaning

Precautions	<ul style="list-style-type: none"> ◆ Cleaning conditions 1. Washing by supersonic waves shall be avoided.
Technical considerations	<ul style="list-style-type: none"> ◆ Cleaning conditions 1. If washed by supersonic waves, the products might be broken.

6. Handling

Precautions	<ul style="list-style-type: none"> ◆ Handling <ol style="list-style-type: none"> 1. Keep the product away from all magnets and magnetic objects. ◆ Breakaway PC boards (splitting along perforations) <ol style="list-style-type: none"> 1. When splitting the PC board after mounting product, care should be taken not to give any stresses of deflection or twisting to the board. 2. Board separation should not be done manually, but by using the appropriate devices. ◆ Mechanical considerations <ol style="list-style-type: none"> 1. Please do not give the product any excessive mechanical shocks. 2. Please do not add any shock and power to a product in transportation. ◆ Pick-up pressure <ol style="list-style-type: none"> 1. Please do not push to add any pressure to a winding part. Please do not give any shock and push into a ferrite core exposure part. ◆ Packing <ol style="list-style-type: none"> 1. Please avoid accumulation of a packing box as much as possible.
Technical considerations	<ul style="list-style-type: none"> ◆ Handling <ol style="list-style-type: none"> 1. There is a case that a characteristic varies with magnetic influence. ◆ Breakaway PC boards (splitting along perforations) <ol style="list-style-type: none"> 1. The position of the product on PCBs shall be carefully considered to minimize the stress caused from splitting of the PCBs. ◆ Mechanical considerations <ol style="list-style-type: none"> 1. There is a case to be damaged by a mechanical shock. 2. There is a case to be broken by the handling in transportation. ◆ Pick-up pressure <ol style="list-style-type: none"> 1. Damage and a characteristic can vary with an excessive shock or stress. ◆ Packing <ol style="list-style-type: none"> 1. If packing boxes are accumulated, that could cause a deformation on packing tapes or a damage on the products.

7. Storage conditions

Precautions	<ul style="list-style-type: none"> ◆ Storage <ol style="list-style-type: none"> 1. To maintain the solderability of terminal electrodes and to keep the packing material in good condition, temperature and humidity in the storage area should be controlled. <ul style="list-style-type: none"> ▪ Recommended conditions <ul style="list-style-type: none"> Ambient temperature : $-5\sim 40^{\circ}\text{C}$ Humidity : Below 70% RH ▪ The ambient temperature must be kept below 30°C. Even under ideal storage conditions, solderability of products electrodes may decrease as time passes. <p style="margin-left: 20px;">For this reason, product should be used within 6 months from the time of delivery.</p> <p style="margin-left: 20px;">In case of storage over 6 months, solderability shall be checked before actual usage.</p>
Technical considerations	<ul style="list-style-type: none"> ◆ Storage <ol style="list-style-type: none"> 1. Under a high temperature and humidity environment, problems such as reduced solderability caused by oxidation of terminal electrodes and deterioration of taping/packaging materials may take place.