

Multilayer Ceramic Capacitors for Automotive Body & Chassis and Infotainment

REFLOW

AEC-Q200

■ PART NUMBER

M	C	A	S	J	3	1	L	S	B	5	1	0	6	K	T	N	A	0	1
①	②	③	④	⑤	⑥	⑦	⑧	⑨	⑩										

① Series

Code (1)(2)(3)(4)	
MCAS	Multilayer Ceramic Capacitor (High dielectric type) for Automotive Body & Chassis and Infotainment Multilayer Ceramic Capacitor (Temperature compensating type) for Automotive Body & Chassis and Infotainment Medium-High voltage Multilayer Ceramic Capacitor for Automotive Body & Chassis and Infotainment
MCAR	High frequency/Low loss Medium-High Voltage Multilayer Ceramic Capacitor for Automotive Body & Chassis and Infotainment
MCJC	Soft Termination Multilayer Ceramic Capacitor for Automotive Body & Chassis and Infotainment
MCRL	LW Reversal Decoupling Low ESL Capacitor (LWDC™) for Automotive Body & Chassis and Infotainment

(1) Product Group

Code	
M	Multilayer Ceramic Capacitor

(2) Category

Code	Recommended equipment	Quality Grade
C	Automotive Electronic Equipment (Body & Chassis, Infotainment)	2

(3) Type

Code	
A	2 terminals
J	Soft Termination
R	LW reversal

(4) Features, Characteristics

Code	
S	Standard/General
R	High frequency/Low loss
C	Internal code (Soft Termination)
L	Low ESL

② Rated voltage

Code	Rated voltage [VDC]
A	4
J	6.3
L	10
E	16
T	25
G	35
U	50
H	100
Q	250
S	630

④ Thickness

Code	Thickness [mm]
3	0.3
5	0.5
7	0.7
8	0.8
9	0.85
Q	1.15
G	1.25
L	1.6
N	1.9 (0.088 max ※)
M	2.5

Note : ※LW reverse type (MCRL)

③ Dimension (L × W)

Code	L × W [mm]	JIS(mm)	EIA(inch)
06	0.6 × 0.3	0603	0201
10	1.0 × 0.5	1005	0402
	0.52 × 1.0 ※	0510	0204
16	1.6 × 0.8	1608	0603
	0.8 × 1.6 ※	0816	0306
21	2.0 × 1.25	2012	0805
	1.25 × 2.0 ※	1220	0508
31	3.2 × 1.6	3216	1206
32	3.2 × 2.5	3225	1210
45	4.5 × 3.2	4532	1812

Note : ※LW reverse type (MCRL)

⑤Dimension tolerance

Code	Dimension code	L[mm]	W[mm]	T[mm]	Thickness code
A	10	1.0±0.10	0.5±0.10	0.5±0.10	5
	16	1.6+0.15/-0.05	0.8+0.15/-0.05	0.8+0.15/-0.05	8
	21	2.0+0.15/-0.05	1.25+0.15/-0.05	1.25+0.15/-0.05	G
	31	3.2±0.20	1.6±0.20	1.15±0.20	Q
	32	3.2±0.30	2.5±0.30	1.6±0.20	L
B	10	1.0+0.15/-0.05	0.5+0.15/-0.05	0.5+0.15/-0.05	5
	16	1.6+0.20/-0	0.8+0.20/-0	0.8+0.20/-0	8
	21	2.0+0.20/-0	1.25+0.20/-0	1.25+0.20/-0	G
	31	3.2±0.30	1.6±0.30	1.6±0.30	L
	32	3.2±0.30	2.5±0.30	2.5±0.30	M
C	10	1.0+0.20/-0	0.5+0.20/-0	0.5+0.20/-0	5
	16	1.6+0.25/-0	0.8+0.25/-0	0.8+0.25/-0	8
	21	2.0+0.25/-0	1.25+0.25/-0	1.25+0.25/-0	G
D	21	2.0+0.30/-0	1.25+0.30/-0	1.25+0.30/-0	G
H	31	3.2±0.15	1.6±0.15	1.15±0.10	Q
J	21	2.0+0.15/-0.05	1.25+0.15/-0.05	0.85±0.10	9
L	21	2.0+0.20/-0	1.25+0.20/-0	0.85±0.10	9
	32	3.2±0.50	2.5±0.30	2.5±0.30	M
N	21	2.0±0.15	1.25±0.15	0.85±0.15	9
S	06	0.6±0.03	0.3±0.03	0.3±0.03	3
	10	1.0±0.05	0.5±0.05	0.5±0.05	5
		0.52±0.05 ※	1.0±0.05	0.3±0.05	3
	16	1.6±0.10	0.8±0.10	0.7±0.10	7
		0.8±0.10 ※	1.6±0.10	0.8±0.10	8
	21	2.0±0.10	1.25±0.10	0.5±0.05	5
		2.0±0.10	1.25±0.10	0.85±0.10	9
		1.25±0.15 ※	2.0±0.15	1.25±0.10	G
	31	3.2±0.15	1.6±0.15	0.85±0.10	9
	32	3.2±0.15	1.6±0.15	1.6±0.20	L
		3.2±0.30	2.5±0.20	1.9±0.20	N
3.2±0.30		2.5±0.20	2.5±0.20	M	
45	4.5±0.40	3.2±0.30	2.5±0.20	M	

Note :※LW reverse type (MCRL)

⑥ Temperature characteristics code

■ High dielectric type

Code	Applicable standard		Temperature range [°C]	Ref. Temp. [°C]	Capacitance change	Capacitance tolerance	Tolerance code
B5	EIA	X5R	-55 ~ + 85	25	± 15%	± 10%	K
						± 20%	M
C6	EIA	X6S	-55 ~ + 105	25	± 22%	± 10%	K
						± 20%	M
B7	EIA	X7R	-55 ~ + 125	25	± 15%	± 10%	K
						± 20%	M
C7	EIA	X7S	-55 ~ + 125	25	± 22%	± 10%	K
						± 20%	M
D7	EIA	X7T	-55 ~ + 125	25	+ 22% / - 33%	± 10%	K
						± 20%	M

■ Temperature compensating type

Code	Applicable standard		Temperature range [°C]	Ref. Temp. [°C]	Capacitance change	Capacitance tolerance	Tolerance code
CG	JIS	CG	-55 ~ + 125	20	0 ± 30ppm/°C	± 0.05pF	A
						± 0.1pF	B
	± 0.25pF	C					
	EIA	C0G		25		± 0.5pF	D
						± 2%	G
± 5%			J				
CH	JIS	CH	-55 ~ + 125	20	0 ± 60ppm/°C	± 0.25pF	C
						± 0.5pF	D
	EIA	C0H		25		± 5%	J
CJ	JIS	CJ	-55 ~ + 125	20	0 ± 120ppm/°C	± 0.25pF	C
	EIA	C0J					
CK	JIS	CK	-55 ~ + 125	20	0 ± 250ppm/°C	± 0.25pF	C
	EIA	C0K		25			

⑦ Nominal capacitance

Code (example)	Nominal capacitance
0R5	0.5pF
010	1pF
100	10pF
101	100pF
102	1,000pF
103	0.01μF
104	0.1μF
105	1μF
106	10μF
107	100μF

Note : R=Decimal point

⑧ Capacitance tolerance

Code	Capacitance tolerance
A	± 0.05pF
B	± 0.1pF
C	± 0.25pF
D	± 0.5pF
G	± 2%
J	± 5%
K	± 10%
M	± 20%

⑨ Packaging

Code	Packaging
F	φ178mm Taping (2mm pitch)
R	φ178mm Embossed Taping (4mm pitch)
T	φ178mm Taping (4mm pitch)
P	φ178mm Taping (4mm pitch, 1000 pcs/reel) 3225 type (Thickness code M)

⑩ Internal code

STANDARD EXTERNAL DIMENSIONS

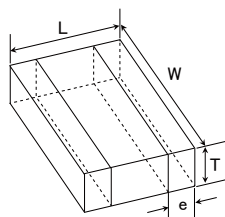
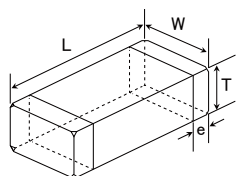

※LW reverse type

Type	JIS (mm)	EIA (inch)	Dimension [mm] (inch)				
			L	W	T	*1	e
MCAS□06	0603	0201	0.6±0.03 (0.024±0.001)	0.3±0.03 (0.012±0.001)	0.3±0.03 (0.012±0.001)	3	0.15±0.05 (0.006±0.002)
MCAR□10 MCAS□10	1005	0402	1.0±0.05 (0.039±0.002)	0.5±0.05 (0.020±0.002)	0.5±0.05 (0.020±0.002)	5	0.25±0.10 (0.010±0.004)
MCRL□10 ※	0510	0204	0.52±0.05 (0.020±0.002)	1.0±0.05 (0.039±0.002)	0.3±0.05 (0.012±0.002)	3	0.18±0.08 (0.007±0.003)
MCAS□16 MCAR□16	1608	0603	1.6±0.10 (0.063±0.004)	0.8±0.10 (0.031±0.004)	0.7±0.10 (0.028±0.004)	7	0.35±0.25 (0.014±0.010)
					0.8±0.10 (0.031±0.004)	8	
MCJC□16	1608	0603	1.6±0.10 (0.063±0.004)	0.8±0.10 (0.031±0.004)	0.8±0.10 (0.031±0.004)	8	0.35+0.3/-0.25 (0.014+0.012/-0.010)
MCRL□16 ※	0816	0306	0.8±0.10 (0.031±0.004)	1.6±0.10 (0.063±0.004)	0.5±0.05 (0.020±0.002)	5	0.25±0.15 (0.010±0.006)
MCAS□21 MCAR□21	2012	0805	2.0±0.10 (0.079±0.004)	1.25±0.10 (0.049±0.004)	0.85±0.10 (0.033±0.004)	9	0.5±0.25 (0.020±0.010)
					1.25±0.10 (0.049±0.004)	G	
MCJC□21	2012	0805	2.0±0.10 (0.079±0.004)	1.25±0.10 (0.049±0.004)	0.85±0.10 (0.033±0.004)	9	0.5+0.35/-0.25 (0.020+0.014/-0.010)
					1.25±0.10 (0.049±0.004)	G	
MCRL□21 ※	1220	0508	1.25±0.15 (0.049±0.006)	2.0±0.15 (0.079±0.006)	0.85±0.10 (0.033±0.004)	9	0.3±0.2 (0.012±0.008)
MCAS□31	3216	1206	3.2±0.15 (0.126±0.006)	1.6±0.15 (0.063±0.006)	1.15±0.10 (0.045±0.004)	Q	0.5+0.35/-0.25 (0.020+0.014/-0.010)
					1.6±0.20 (0.063±0.008)	L	
MCJC□31	3216	1206	3.2±0.15 (0.126±0.006)	1.6±0.15 (0.063±0.006)	1.15±0.10 (0.045±0.004)	Q	0.6+0.4/-0.3 (0.024+0.016/-0.012)
					1.6±0.20 (0.063±0.008)	L	
MCAS□32	3225	1210	3.2±0.30 (0.126±0.012)	2.5±0.20 (0.098±0.008)	1.9±0.20 (0.075±0.008)	N	0.6±0.3 (0.024±0.012)
					2.5±0.20 (0.098±0.008)	M	
MCJC□32	3225	1210	3.2±0.30 (0.126±0.012)	2.5±0.20 (0.098±0.008)	1.9±0.20 (0.075±0.008)	N	0.6+0.4/-0.3 (0.024+0.016/-0.012)
					2.5±0.20 (0.098±0.008)	M	
MCAS□45	4532	1812	4.5±0.40 (0.177±0.016)	3.2±0.30 (0.126±0.012)	2.5±0.20 (0.098±0.008)	M	0.9±0.6 (0.035±0.024)

Note :※LW reverse type (MCRL), *1.Thickness code

■ STANDARD QUANTITY

Type			Thickness		Standard quantity [pcs]	
Code	JIS(mm)	EIA(inch)	[mm]	Code	Paper tape	Embossed tape
06	0603	0201	0.3	3	15000	—
10	1005	0402	0.5	5	10000	—
	0510 ※	0204 ※	0.3	3		
16	1608	0603	0.7	7	4000	—
			0.8	8		
			0.8	8	3000 (Soft Termination)	3000 (Soft Termination)
			0.5	5	—	4000
21	2012	0805	0.85	9	4000	—
			1.25	G	—	3000
			1.25	G	—	2000 (Soft Termination)
			0.85	9	4000	—
31	3216	1206	1.15	Q	—	3000
			1.6	L	—	2000
32	3225	1210	1.9	N	—	2000
			2.5	M	—	500(T), 1000(P)
45	4532	1812	2.5	M	—	500

Note : ※.LW Reverse type (MCRL)

PART NUMBER

Medium-High Voltage Multilayer Ceramic Capacitors for Automotive Body & Chassis and Infotainment

1005TYPE

【Temperature Characteristic B7 : X7R(-55~+125°C), C7 : X7S(-55~+125°C)】 0.5mm Thickness

New part number	Old part number (for reference)	Rated voltage [V]	Temperature characteristics	Capacitance [F]	Capacitance tolerance [%]	tan δ [%]	HTLT	Thickness*1 [mm]	Note
							Rated voltage x %		
MCASH105SB7221[FCA01	HMK105 B7221[VHFE	100	X7R	220 p	±10, ±20	3.5	200	0.5±0.05	
MCASH105SB7331[FCA01	HMK105 B7331[VHFE	100	X7R	330 p	±10, ±20	3.5	200	0.5±0.05	
MCASH105SB7471[FCA01	HMK105 B7471[VHFE	100	X7R	470 p	±10, ±20	3.5	200	0.5±0.05	
MCASH105SB7681[FCA01	HMK105 B7681[VHFE	100	X7R	680 p	±10, ±20	3.5	200	0.5±0.05	
MCASH105SB7102[FCA01	HMK105 B7102[VHFE	100	X7R	1000 p	±10, ±20	3.5	200	0.5±0.05	
MCASH105SB7152[FCA01	HMK105 B7152[VHFE	100	X7R	1500 p	±10, ±20	3.5	200	0.5±0.05	
MCASH105SB7222[FCA01	HMK105 B7222[VHFE	100	X7R	2200 p	±10, ±20	3.5	200	0.5±0.05	
MCASH105SB7332[FCA01	HMK105 B7332[VHFE	100	X7R	3300 p	±10, ±20	3.5	200	0.5±0.05	
MCASH105SB7472[FCA01	HMK105 B7472[VHFE	100	X7R	4700 p	±10, ±20	3.5	200	0.5±0.05	
MCASH105SB7682[FCA01	HMK105 B7682[VHFE	100	X7R	6800 p	±10, ±20	3.5	200	0.5±0.05	
MCASH105SB7103[FCA01	HMK105 B7103[VHFE	100	X7R	0.01 μ	±10, ±20	3.5	200	0.5±0.05	

1608TYPE

【Temperature Characteristic B7 : X7R(-55~+125°C), C7 : X7S(-55~+125°C)】 0.8mm Thickness

New part number	Old part number (for reference)	Rated voltage [V]	Temperature characteristics	Capacitance [F]	Capacitance tolerance [%]	tan δ [%]	HTLT	Thickness*1 [mm]	Note
							Rated voltage x %		
MCASH168SB7102[TNA01	HMK107 B7102[AHT	100	X7R	1000 p	±10, ±20	3.5	200	0.8±0.10	
MCASH168SB7152[TNA01	HMK107 B7152[AHT	100	X7R	1500 p	±10, ±20	3.5	200	0.8±0.10	
MCASH168SB7222[TNA01	HMK107 B7222[AHT	100	X7R	2200 p	±10, ±20	3.5	200	0.8±0.10	
MCASH168SB7332[TNA01	HMK107 B7332[AHT	100	X7R	3300 p	±10, ±20	3.5	200	0.8±0.10	
MCASH168SB7472[TNA01	HMK107 B7472[AHT	100	X7R	4700 p	±10, ±20	3.5	200	0.8±0.10	
MCASH168SB7682[TNA01	HMK107 B7682[AHT	100	X7R	6800 p	±10, ±20	3.5	200	0.8±0.10	
MCASH168SB7103[TNA01	HMK107 B7103[AHT	100	X7R	0.01 μ	±10, ±20	3.5	200	0.8±0.10	
MCASH168SB7153[TNA01	HMK107 B7153[AHT	100	X7R	0.015 μ	±10, ±20	3.5	200	0.8±0.10	
MCASH168SB7223[TNA01	HMK107 B7223[AHT	100	X7R	0.022 μ	±10, ±20	3.5	200	0.8±0.10	
MCASH168SB7333[TNA01	HMK107 B7333[AHT	100	X7R	0.033 μ	±10, ±20	3.5	200	0.8±0.10	
MCASH168SB7473[TNA01	HMK107 B7473[AHT	100	X7R	0.047 μ	±10, ±20	3.5	200	0.8±0.10	
MCASH168AB7683[TCA01	HMK107AB7683[AHTE	100	X7R	0.068 μ	±10, ±20	3.5	200	0.8+0.15/-0.05	
MCASH168SB7104[TNA01	HMK107 B7104[AHT	100	X7R	0.1 μ	±10, ±20	3.5	200	0.8±0.10	
MCASH168AC7154[TCA01	HMK107AC7154[AHTE	100	X7S	0.15 μ	±10, ±20	3.5	150	0.8+0.15/-0.05	
MCASH168SC7224[TCA01	HMK107 C7224[AHTE	100	X7S	0.22 μ	±10, ±20	3.5	150	0.8±0.10	

2012TYPE

【Temperature Characteristic B7 : X7R(-55~+125°C), C7 : X7S(-55~+125°C)】 1.25mm Thickness

New part number	Old part number (for reference)	Rated voltage [V]	Temperature characteristics	Capacitance [F]	Capacitance tolerance [%]	tan δ [%]	HTLT	Thickness*1 [mm]	Note
							Rated voltage x %		
MCASH21GSB7472[TNA01	HMK212 B7472[GHT	100	X7R	4700 p	±10, ±20	2.5	200	1.25±0.10	
MCASH21GSB7682[TNA01	HMK212 B7682[GHT	100	X7R	6800 p	±10, ±20	2.5	200	1.25±0.10	
MCASH21GSB7103[TNA01	HMK212 B7103[GHT	100	X7R	0.01 μ	±10, ±20	3.5	200	1.25±0.10	
MCASH21GSB7153[TNA01	HMK212 B7153[GHT	100	X7R	0.015 μ	±10, ±20	3.5	200	1.25±0.10	
MCASH21GSB7223[TNA01	HMK212 B7223[GHT	100	X7R	0.022 μ	±10, ±20	3.5	200	1.25±0.10	
MCASH21GSB7333[TNA01	HMK212 B7333[GHT	100	X7R	0.033 μ	±10, ±20	3.5	200	1.25±0.10	
MCASH21GSB7473[TNA01	HMK212 B7473[GHT	100	X7R	0.047 μ	±10, ±20	3.5	200	1.25±0.10	
MCASH21GSB7683[TNA01	HMK212 B7683[GHT	100	X7R	0.068 μ	±10, ±20	3.5	200	1.25±0.10	
MCASH21GSB7104[TNA01	HMK212 B7104[GHT	100	X7R	0.1 μ	±10, ±20	3.5	200	1.25±0.10	
MCASH21GBB7154[TCA01	HMK212BB7154[GHTE	100	X7R	0.15 μ	±10, ±20	3.5	200	1.25+0.20/-0	
MCASH21GSB7224[TNA01	HMK212 B7224[GHT	100	X7R	0.22 μ	±10, ±20	3.5	200	1.25±0.10	
MCASH21GBC7334[TCA01	HMK212BC7334[GHTE	100	X7S	0.33 μ	±10, ±20	3.5	150	1.25+0.20/-0	
MCASH21GSC7474[TCA01	HMK212 C7474[GHTE	100	X7S	0.47 μ	±10, ±20	3.5	150	1.25±0.10	
MCASH21GCC7684[TCA01	HMK212CC7684[GHTE	100	X7S	0.68 μ	±10, ±20	3.5	150	1.25+0.25/-0	
MCASH21GBC7105[TCA01	HMK212BC7105[GHTE	100	X7S	1 μ	±10, ±20	3.5	150	1.25+0.20/-0	
MCASQ21GSB7472[TNA01	QMK212 B7472[GHT	250	X7R	4700 p	±10, ±20	2.5	150	1.25±0.10	
MCASQ21GSB7682[TNA01	QMK212 B7682[GHT	250	X7R	6800 p	±10, ±20	2.5	150	1.25±0.10	
MCASQ21GSB7103[TNA01	QMK212 B7103[GHT	250	X7R	0.01 μ	±10, ±20	2.5	150	1.25±0.10	
MCASQ21GSB7153[TNA01	QMK212 B7153[GHT	250	X7R	0.015 μ	±10, ±20	2.5	150	1.25±0.10	
MCASQ21GSB7223[TNA01	QMK212 B7223[GHT	250	X7R	0.022 μ	±10, ±20	2.5	150	1.25±0.10	

【Temperature Characteristic B7 : X7R(-55~+125°C)】 0.85mm Thickness

New part number	Old part number (for reference)	Rated voltage [V]	Temperature characteristics	Capacitance [F]	Capacitance tolerance [%]	tan δ [%]	HTLT	Thickness*1 [mm]	Note
							Rated voltage x %		
MCASH219SB7102[TNA01	HMK212 B7102[DHT	100	X7R	1000 p	±10, ±20	2.5	200	0.85±0.10	
MCASH219SB7152[TNA01	HMK212 B7152[DHT	100	X7R	1500 p	±10, ±20	2.5	200	0.85±0.10	
MCASH219SB7222[TNA01	HMK212 B7222[DHT	100	X7R	2200 p	±10, ±20	2.5	200	0.85±0.10	
MCASH219SB7332[TNA01	HMK212 B7332[DHT	100	X7R	3300 p	±10, ±20	2.5	200	0.85±0.10	
MCASQ219SB7102[TNA01	QMK212 B7102[DHT	250	X7R	1000 p	±10, ±20	2.5	150	0.85±0.10	
MCASQ219SB7152[TNA01	QMK212 B7152[DHT	250	X7R	1500 p	±10, ±20	2.5	150	0.85±0.10	
MCASQ219SB7222[TNA01	QMK212 B7222[DHT	250	X7R	2200 p	±10, ±20	2.5	150	0.85±0.10	
MCASQ219SB7332[TNA01	QMK212 B7332[DHT	250	X7R	3300 p	±10, ±20	2.5	150	0.85±0.10	

PART NUMBER

3216TYPE

【Temperature Characteristic B7 : X7R(-55~+125°C), C7 : X7S(-55~+125°C)】 1.6mm Thickness

New part number	Old part number (for reference)	Rated voltage [V]	Temperature characteristics	Capacitance [F]	Capacitance tolerance [%]	tan δ [%]	HTLT	Thickness*1 [mm]	Note
							Rated voltage x %		
MCASH31LSB7473□TNA01	HMK316 B7473□LHT	100	X7R	0.047 μ	±10, ±20	3.5	200	1.6±0.20	
MCASH31LSB7683□TNA01	HMK316 B7683□LHT	100	X7R	0.068 μ	±10, ±20	3.5	200	1.6±0.20	
MCASH31LSB7104□TNA01	HMK316 B7104□LHT	100	X7R	0.1 μ	±10, ±20	3.5	200	1.6±0.20	
MCASH31LSB7154□TNA01	HMK316 B7154□LHT	100	X7R	0.15 μ	±10, ±20	3.5	200	1.6±0.20	
MCASH31LSB7224□TNA01	HMK316 B7224□LHT	100	X7R	0.22 μ	±10, ±20	3.5	200	1.6±0.20	
MCASH31LSB7334□TNA01	HMK316 B7334□LHT	100	X7R	0.33 μ	±10, ±20	3.5	200	1.6±0.20	
MCASH31LSB7474□TNA01	HMK316 B7474□LHT	100	X7R	0.47 μ	±10, ±20	3.5	200	1.6±0.20	
MCASH31LSB7105□TNA01	HMK316 B7105□LHT	100	X7R	1 μ	±10, ±20	3.5	200	1.6±0.20	
MCASH31LBC7155□TCA01	HMK316BC7155□LHTE	100	X7S	1.5 μ	±10, ±20	3.5	150	1.6±0.30	
MCASH31LAC7225□TCA01	HMK316AC7225□LHTE	100	X7S	2.2 μ	±10, ±20	3.5	150	1.6±0.20	
MCASQ31LSB7223□TNA01	QMK316 B7223□LHT	250	X7R	0.022 μ	±10, ±20	2.5	150	1.6±0.20	
MCASQ31LSB7333□TNA01	QMK316 B7333□LHT	250	X7R	0.033 μ	±10, ±20	2.5	150	1.6±0.20	
MCASQ31LSB7473□TNA01	QMK316 B7473□LHT	250	X7R	0.047 μ	±10, ±20	2.5	150	1.6±0.20	
MCASQ31LSB7683□TNA01	QMK316 B7683□LHT	250	X7R	0.068 μ	±10, ±20	2.5	150	1.6±0.20	
MCASQ31LSB7104□TNA01	QMK316 B7104□LHT	250	X7R	0.1 μ	±10, ±20	2.5	150	1.6±0.20	
MCASS31LSB7153□TNA01	SMK316 B7153□LHT	630	X7R	0.015 μ	±10, ±20	2.5	120	1.6±0.20	
MCASS31LSB7223□TNA01	SMK316 B7223□LHT	630	X7R	0.022 μ	±10, ±20	2.5	120	1.6±0.20	
MCASS31LAB7333□TNA01	SMK316AB7333□LHT	630	X7R	0.033 μ	±10, ±20	2.5	120	1.6±0.20	
MCASS31LAB7473□TNA01	SMK316AB7473□LHT	630	X7R	0.047 μ	±10, ±20	2.5	120	1.6±0.20	

【Temperature Characteristic B7 : X7R(-55~+125°C)】 1.15mm Thickness

New part number	Old part number (for reference)	Rated voltage [V]	Temperature characteristics	Capacitance [F]	Capacitance tolerance [%]	tan δ [%]	HTLT	Thickness*1 [mm]	Note
							Rated voltage x %		
MCASS31QHB7102□TNA01	SMK316 B7102□FHT	630	X7R	1000 p	±10, ±20	2.5	120	1.15±0.10	
MCASS31QHB7152□TNA01	SMK316 B7152□FHT	630	X7R	1500 p	±10, ±20	2.5	120	1.15±0.10	
MCASS31QHB7222□TNA01	SMK316 B7222□FHT	630	X7R	2200 p	±10, ±20	2.5	120	1.15±0.10	
MCASS31QHB7332□TNA01	SMK316 B7332□FHT	630	X7R	3300 p	±10, ±20	2.5	120	1.15±0.10	
MCASS31QHB7472□TNA01	SMK316 B7472□FHT	630	X7R	4700 p	±10, ±20	2.5	120	1.15±0.10	
MCASS31QHB7682□TNA01	SMK316 B7682□FHT	630	X7R	6800 p	±10, ±20	2.5	120	1.15±0.10	
MCASS31QHB7103□TNA01	SMK316 B7103□FHT	630	X7R	0.01 μ	±10, ±20	2.5	120	1.15±0.10	

3225TYPE

【Temperature Characteristic B7 : X7R(-55~+125°C), C7 : X7S(-55~+125°C)】 2.5mm Thickness

New part number	Old part number (for reference)	Rated voltage [V]	Temperature characteristics	Capacitance [F]	Capacitance tolerance [%]	tan δ [%]	HTLT	Thickness*1 [mm]	Note
							Rated voltage x %		
MCASH32MSB7225□PNA01	HMK325 B7225□MHP	100	X7R	2.2 μ	±10, ±20	3.5	200	2.5±0.20	
MCASH32MSC7475□PCA01	HMK325 C7475□MHPE	100	X7S	4.7 μ	±10, ±20	3.5	150	2.5±0.20	

【Temperature Characteristic B7 : X7R(-55~+125°C)】 1.9mm Thickness

New part number	Old part number (for reference)	Rated voltage [V]	Temperature characteristics	Capacitance [F]	Capacitance tolerance [%]	tan δ [%]	HTLT	Thickness*1 [mm]	Note
							Rated voltage x %		
MCASH32NSB7224□TNA01	HMK325 B7224□NHT	100	X7R	0.22 μ	±10, ±20	3.5	200	1.9±0.20	
MCASH32NSB7474□TNA01	HMK325 B7474□NHT	100	X7R	0.47 μ	±10, ±20	3.5	200	1.9±0.20	
MCASH32NSB7684□TNA01	HMK325 B7684□NHT	100	X7R	0.68 μ	±10, ±20	3.5	200	1.9±0.20	
MCASH32NSB7105□TNA01	HMK325 B7105□NHT	100	X7R	1 μ	±10, ±20	3.5	200	1.9±0.20	
MCASQ32NSB7473□TNA01	QMK325 B7473□NHT	250	X7R	0.047 μ	±10, ±20	2.5	150	1.9±0.20	
MCASQ32NSB7104□TNA01	QMK325 B7104□NHT	250	X7R	0.1 μ	±10, ±20	2.5	150	1.9±0.20	
MCASQ32NSB7154□TNA01	QMK325 B7154□NHT	250	X7R	0.15 μ	±10, ±20	2.5	150	1.9±0.20	
MCASQ32NSB7224□TNA01	QMK325 B7224□NHT	250	X7R	0.22 μ	±10, ±20	2.5	150	1.9±0.20	
MCASS32NSB7223□TNA01	SMK325 B7223□NHT	630	X7R	0.022 μ	±10, ±20	2.5	120	1.9±0.20	
MCASS32NSB7333□TNA01	SMK325 B7333□NHT	630	X7R	0.033 μ	±10, ±20	2.5	120	1.9±0.20	
MCASS32NSB7473□TNA01	SMK325 B7473□NHT	630	X7R	0.047 μ	±10, ±20	2.5	120	1.9±0.20	

4532TYPE

【Temperature Characteristic B7 : X7R(-55~+125°C)】 2.5mm Thickness

New part number	Old part number (for reference)	Rated voltage [V]	Temperature characteristics	Capacitance [F]	Capacitance tolerance [%]	tan δ [%]	HTLT	Thickness*1 [mm]	Note
							Rated voltage x %		
MCASH45MSB7474□TNA01	HMK432 B7474□MHT	100	X7R	0.47 μ	±10, ±20	3.5	200	2.5±0.20	
MCASH45MSB7105□TNA01	HMK432 B7105□MHT	100	X7R	1 μ	±10, ±20	3.5	200	2.5±0.20	
MCASH45MSB7155□TNA01	HMK432 B7155□MHT	100	X7R	1.5 μ	±10, ±20	3.5	200	2.5±0.20	
MCASH45MSB7225□TNA01	HMK432 B7225□MHT	100	X7R	2.2 μ	±10, ±20	3.5	200	2.5±0.20	
MCASQ45MSB7104□TNA01	QMK432 B7104□MHT	250	X7R	0.1 μ	±10, ±20	2.5	150	2.5±0.20	
MCASQ45MSB7224□TNA01	QMK432 B7224□MHT	250	X7R	0.22 μ	±10, ±20	2.5	150	2.5±0.20	
MCASQ45MSB7334□TNA01	QMK432 B7334□MHT	250	X7R	0.33 μ	±10, ±20	2.5	150	2.5±0.20	
MCASQ45MSB7474□TNA01	QMK432 B7474□MHT	250	X7R	0.47 μ	±10, ±20	2.5	150	2.5±0.20	
MCASS45MSB7473□TNA01	SMK432 B7473□MHT	630	X7R	0.047 μ	±10, ±20	2.5	120	2.5±0.20	
MCASS45MSB7683□TNA01	SMK432 B7683□MHT	630	X7R	0.068 μ	±10, ±20	2.5	120	2.5±0.20	
MCASS45MSB7104□TNA01	SMK432 B7104□MHT	630	X7R	0.1 μ	±10, ±20	2.5	120	2.5±0.20	

Multilayer Ceramic Capacitors

PACKAGING

① Minimum Quantity

● Taped package

Type			Thickness		Standard Quantity [pcs]	
Code	JIS(mm)	EIA(inch)	[mm]	Code	Paper tape	Embossed tape
02	0201	008004	0.125	1	—	50000
04	0402	01005	0.2	2	—	40000
06	0603	0201	0.3	3	15000	—
1L	1005	0402	0.13	H	—	20000
			0.18	E	—	15000
			0.2	2	20000	—
			0.3	3	15000	—
10	1005	0402	0.5	5	10000	—
	0510 ※	0204	0.3	3	10000	—
16	1608	0603	0.45	K	4000	—
			0.7	7		
			0.8	8		
			0.8	8	3000 (Soft Termination)	3000 (Soft Termination)
	0816 ※	0306	0.5	5	—	4000
21	2012	0805	0.85	9	4000	—
			1.25	G	—	3000
			1.25	G	—	2000 (Soft Termination)
	1220 ※	0508	0.85	9	4000	—
31	3216	1206	0.85	9	4000	—
			1.15	Q	—	3000
			1.6	L	—	2000
32	3225	1210	0.85	9	—	2000
			1.15	Q		
			1.9	N		
			2.0 max	Y		
			2.5	M	—	500(T), 1000(P)
45	4532	1812	2.0 max	Y	—	1000
			2.5	M	—	500

注: ※LW Reverse type (MSRL, MCRL, MBRL, MLRL, MMRL)

② Taping material

※ No bottom tape for pressed carrier tape

- Card board carrier tape
- Embossed tape

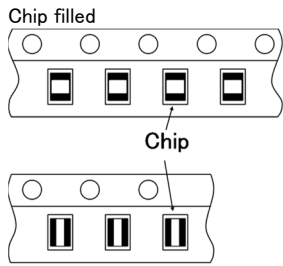
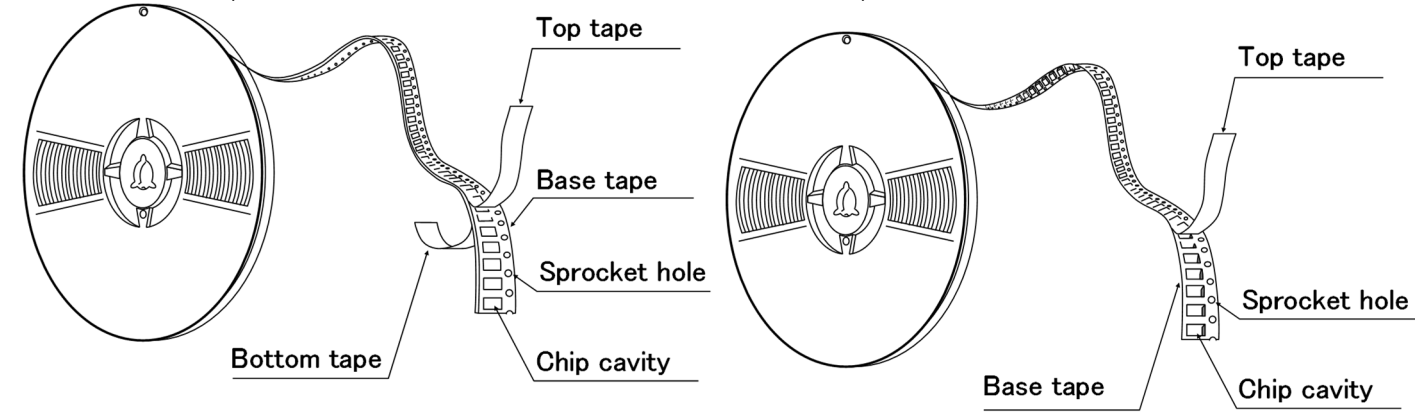

※ LW Reverse type.

③ Representative taping dimensions

● Paper Tape (8mm wide)

● Pressed carrier tape (2mm pitch)

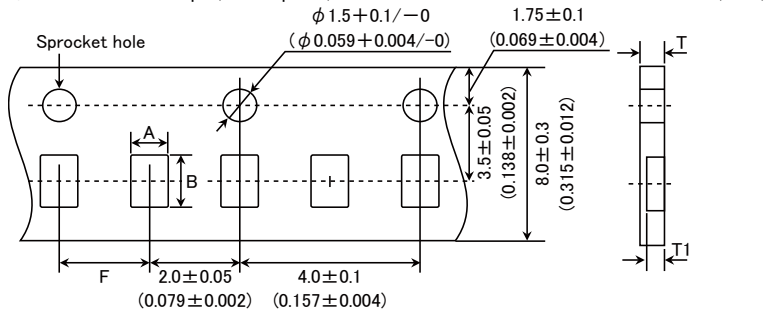

Type(EIA)	Chip Cavity		Insertion Pitch F	Tape Thickness	
	A	B		T	T1
0603 (0201)	0.37	0.67	2.0±0.05	0.45max.	0.42max.
0510 (0204) ※	0.65	1.15		0.4max.	0.3max.
1005 (0402) (*1 2)				0.45max.	0.42max.
1005 (0402) (*1 3)					

Note *1 Thickness, 2:0.2mm, 3:0.3mm. ※ LW Reverse type.

Unit: mm

● Punched carrier tape (2mm pitch)

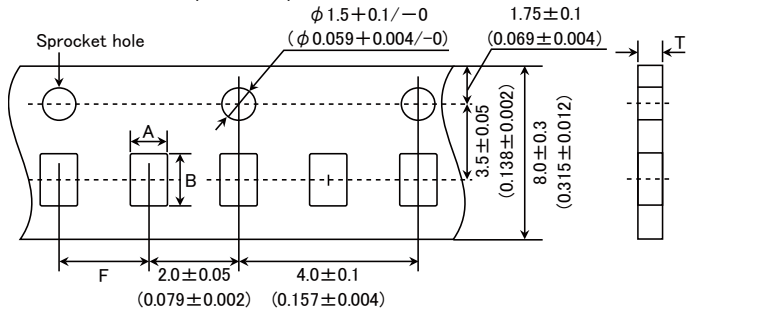

Type(EIA)	Chip Cavity		Insertion Pitch F	Tape Thickness
	A	B		T
1005 (0402)	0.65	1.15	2.0±0.05	0.8max.

Unit: mm

► This catalog contains the typical specification only due to the limitation of space. When you consider the purchase of our products, please check our specification. For details of each product (characteristics graph, reliability information, precautions for use, and so on), see our Web site (<http://www.ty-top.com/>).

● Punched carrier tape (4mm pitch)

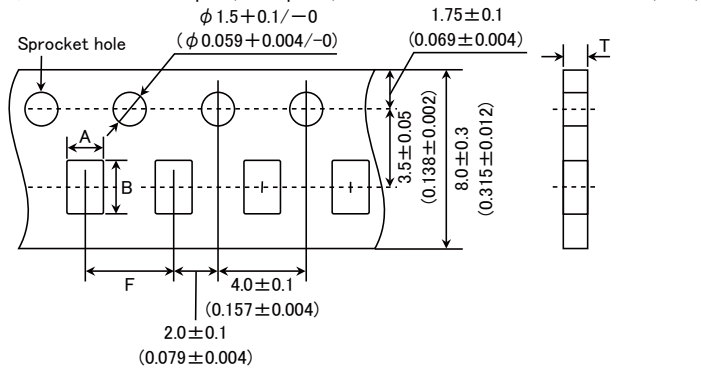

Type(EIA)	Chip Cavity		Insertion Pitch F	Tape Thickness	
	A	B		K	T
1608 (0603)	1.0	1.8	4.0 ± 0.1	1.1max.	1.1max.
0816 (0306) ※					
2012 (0805)					
1220 (0508) ※	1.65	2.4	4.0 ± 0.1	1.1max.	1.1max.
3216 (1206)	2.0	3.6			

Note: Taping size might be different depending on the size of the product. ※ LW Reverse type.

Unit: mm

● Embossed tape (4mm wide)

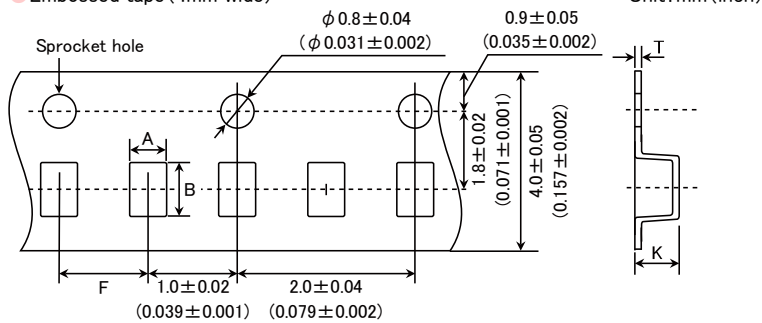

Type(EIA)	Chip Cavity		Insertion Pitch F	Tape Thickness	
	A	B		K	T
0201 (008004)	0.135	0.27	1.0 ± 0.02	0.5max.	0.25max.
0402 (01005)	0.23	0.43			

Unit: mm

● Embossed tape (8mm wide)

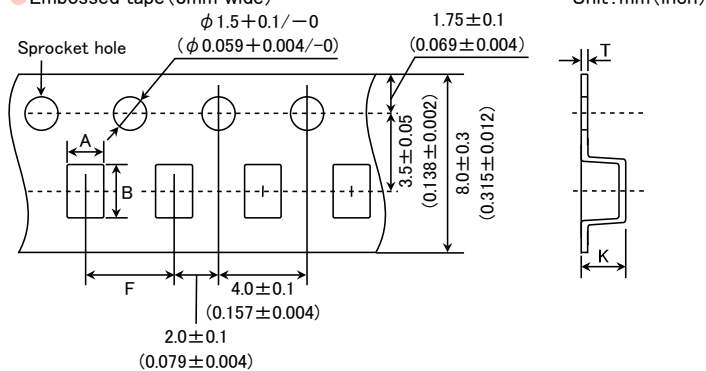

Type(EIA)	Chip Cavity		Insertion Pitch F	Tape Thickness	
	A	B		K	T
1005 (0402)	0.6	1.1	2.0 ± 0.1	0.6max	0.2 ± 0.1
0816 (0306) ※	1.0	1.8	4.0 ± 0.1	1.3max.	0.25 ± 0.1
2012 (0805)	1.65	2.4			
3216 (1206)	2.0	3.6		3.4max.	0.6max.
3225 (1210)	2.8	3.6			

Note: ※ LW Reverse type.

Unit: mm

► This catalog contains the typical specification only due to the limitation of space. When you consider the purchase of our products, please check our specification. For details of each product (characteristics graph, reliability information, precautions for use, and so on), see our Web site (<http://www.ty-top.com/>).

● Embossed tape (12mm wide) Unit: mm (inch)

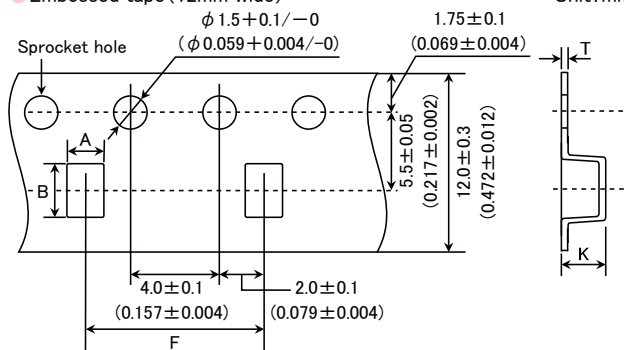

Type(EIA)	Chip Cavity		Insertion Pitch	Tape Thickness	
	A	B		K	T
3225 (1210)	3.1	4.0	8.0 ± 0.1	4.0max.	0.6max.
4532 (1812)	3.7	4.9	8.0 ± 0.1	4.0max.	0.6max.

Unit: mm

④ Trailer and Leader

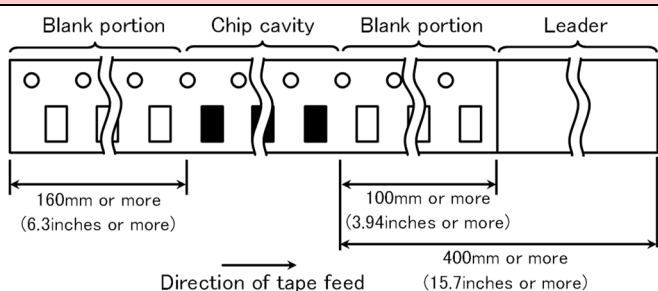

⑤ Reel size

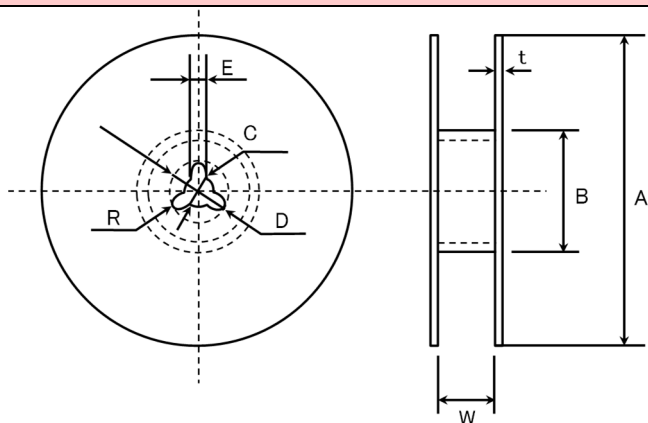

A	B	C	D	E	R
$\phi 178 \pm 2.0$	$\phi 50 \text{min.}$	$\phi 13.0 \pm 0.2$	$\phi 21.0 \pm 0.8$	2.0 ± 0.5	1.0

	T	W
4mm wide tape	1.5max.	5 ± 1.0
8mm wide tape	2.5max.	10 ± 1.5
12mm wide tape	2.5max.	14 ± 1.5

Unit: mm

⑥ Top Tape Strength

The top tape requires a peel-off force of 0.1 to 0.7N in the direction of the arrow as illustrated below.

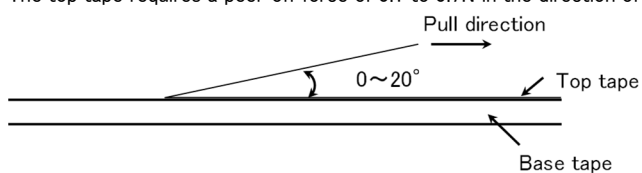

▶ This catalog contains the typical specification only due to the limitation of space. When you consider the purchase of our products, please check our specification. For details of each product (characteristics graph, reliability information, precautions for use, and so on), see our Web site (<http://www.ty-top.com/>).

Multilayer Ceramic Capacitors for Automotive Body & Chassis and Infotainment

RELIABILITY DATA

1. Operating Temperature Range

Specified Value	Temperature Compensating (Class1)	-55 to +125°C		
	High Permittivity (Class2)		Specification	Temperature Range
		B5	X5R	-55 to +85°C
		B7	X7R	-55 to +125°C
		C6	X6S	-55 to +105°C
		C7	X7S	-55 to +125°C
D7	X7T	-55 to +125°C		

2. Storage Conditions

Specified Value	Temperature Compensating (Class1)	-55 to +125°C		
	High Permittivity (Class2)		Specification	Temperature Range
		B5	X5R	-55 to +85°C
		B7	X7R	-55 to +125°C
		C6	X6S	-55 to +105°C
		C7	X7S	-55 to +125°C
D7	X7T	-55 to +125°C		

3. Rated Voltage

Specified Value	Temperature Compensating (Class1)	Standard	50VDC, 25VDC
		High Frequency Type	250VDC
	High Permittivity (Class2)		630VDC, 250VDC, 100VDC 50VDC, 35VDC, 25VDC, 16VDC, 10VDC, 6.3VDC, 4VDC

4. Withstanding Voltage (Between terminals)

Specified Value	Temperature Compensating (Class1)	No breakdown or damage	
	High Permittivity (Class2)		
Test Methods and Remarks		Class 1	Class 2
	Applied voltage	Rated voltage × 3 Rated voltage (Code Q) × 2	Rated voltage × 2.5 Rated voltage (Code Q) × 2, Rated voltage (Code S) × 1.2
	Duration	1 to 5 sec.	
	Charge/discharge current	50mA max.	

5. Insulation Resistance

Specified Value	Temperature Compensating (Class1)	10000 MΩ min.
	High Permittivity (Class2) Note 1	C ≤ 0.047 μF : 10000 MΩ min. C > 0.047 μF : 500 MΩ · μF (C : Nominal capacitance)
Test Methods and Remarks	Applied voltage	: Rated voltage, 500V (Code S)
	Duration	: 60 ± 5 sec.
	Charge/discharge current	: 50mA max.

► This catalog contains the typical specification only due to the limitation of space. When you consider the purchase of our products, please check our specification. For details of each product (characteristics graph, reliability information, precautions for use, and so on), see our Web site (<http://www.ty-top.com/>).

6. Capacitance (Tolerance)

Specified Value	Temperature Compensating (Class1)	Standard	$C \leq 5\text{pF} : \pm 0.25\text{pF}$ $5\text{pF} < C \leq 10\text{pF} : \pm 0.5\text{pF}$ $C > 10\text{pF} : \pm 5\%$ (C:Nominal capacitance)		
		High Frequency Type	Refer to detailed specification		
	High Permittivity (Class2)		$\pm 10\%$ or $\pm 20\%$		
Test Methods and Remarks		Class 1		Class 2	
		Standard	High Frequency Type	$C \leq 10 \mu\text{F}$	$C > 10 \mu\text{F}$
	Preconditioning	None		Thermal treatment (at 150°C for 1hr) No.9	
	Measuring frequency	1MHz $\pm 10\%$		1kHz $\pm 10\%$	120 ± 10 Hz
	Measuring voltage Note 1	0.5 to 5Vrms		1 ± 0.2 Vrms	0.5 ± 0.1 rms
	Bias application	None			

7. Q or Dissipation Factor

Specified Value	Temperature Compensating (Class1)	Standard	$C < 30\text{pF} : Q \geq 400 + 20C$ $C \geq 30\text{pF} : Q \geq 1000$ (C:Nominal capacitance)		
		High Frequency Type	Refer to detailed specification		
	High Permittivity (Class2) Note 1		2.5% max.		
Test Methods and Remarks		Class 1		Class 2	
		Standard	High Frequency Type	$C \leq 10 \mu\text{F}$	$C > 10 \mu\text{F}$
	Preconditioning	None		Thermal treatment (at 150°C for 1hr) No.9	
	Measuring frequency	1MHz $\pm 10\%$		1kHz $\pm 10\%$	120 ± 10 Hz
	Measuring voltage Note 1	0.5 to 5Vrms		1 ± 0.2 Vrms	0.5 ± 0.1 Vrms
	Bias application	None			

8. Pre- and Post-Stress Electrical test

Measurement at 25 $\pm 5^\circ\text{C}$

9. Heat treatment

Value shall be measured after test sample is heat treated at 150 +0/-10°C for an hour and kept at room temperature for 24 ± 2 hrs.
 ※ Heat treatment is applicable to High dielectric type.

10. High Temperature Exposure (Storage)

Specified Value	Temperature Compensating (Class1)	Standard	Appearance : No abnormality Cap. Change : Within $\pm 3\%$ or $\pm 0.3\text{pF}$, whichever is larger. Q : $C < 10\text{pF} : Q \geq 200 + 10C$ $10 \leq C < 30\text{pF} : Q \geq 275 + 2.5C$ $C \geq 30\text{pF} : Q \geq 350$ (C:Nominal capacitance) IR : 1000M Ω min
		High Frequency Type	Appearance : No abnormality Cap. Change : Within $\pm 3\%$ or $\pm 0.3\text{pF}$, whichever is larger. IR : 1000M Ω min
	High Permittivity (Class2) Note 1		Appearance : No abnormality Cap. Change : Within $\pm 12.5\%$ tan δ : 5% max IR : Within 50M Ω or 100M Ω , whichever is smaller.
Test Methods and Remarks	Heat treatment specified in this specification shall be conducted prior to test. No.9 Temperature: The maximum operating temperature shall be used. Duration: Unpowered 1000 hrs. Measurement shall be performed after test sample following the test is heated at 150+0/-10°C for an hour and kept at room temperature for 24 ± 2 hrs. No.9		

► This catalog contains the typical specification only due to the limitation of space. When you consider the purchase of our products, please check our specification.
 For details of each product (characteristics graph, reliability information, precautions for use, and so on), see our Web site (<http://www.ty-top.com/>).

11. Temperature Cycling			
Specified Value	Temperature Compensating (Class1)	Standard	Appearance : No abnormality Cap. Change : Within $\pm 2.5\%$ or $\pm 0.25\text{pF}$, whichever is larger. Q : Initial value IR : Initial value
		High Frequency Type	Appearance : No abnormality Cap. Change : Within $\pm 2.5\%$ or $\pm 0.25\text{pF}$, whichever is larger. IR : Initial value
	High Permittivity (Class2)		Appearance : No abnormality Cap. Change : Within $\pm 7.5\%$ $\tan \delta$: Initial value IR : Initial value
Test Methods and Remarks	Heat treatment specified in this specification shall be conducted prior to test. No.9 Temperature: Minimum operating temperature to Maximum operating temperature Number of cycles: 1000 cycles Maximum dwell time at each temperature extreme: 30 min Maximum transition time: Within 1 min Measurement shall be performed after test sample following the test is heated at $150+0/-10^\circ\text{C}$ for an hour and kept at room temperature for 24 ± 2 hours. No.9		

12. Destructive Physical Analysis	
Specified Value	No abnormality
Test Methods and Remarks	Per EIA-469

13. Biased Humidity			
Specified Value	Temperature Compensating (Class1)	Standard	Appearance : No abnormality Cap. Change : Within $\pm 7.5\%$ or $\pm 0.75\text{pF}$, whichever is larger. Q : $C < 30\text{pF} : Q \geq 100 + 10C/3$ $C \geq 30\text{pF} : Q \geq 200$ (C: Nominal capacitance) IR : $500M\Omega \text{ min}$
		High Frequency Type	Appearance : No abnormality Cap. Change : $C \leq 2.0\text{pF} : \pm 0.4\text{pF}$ $2.0\text{pF} < C < 10\text{pF} : \pm 0.75\text{pF}$ $C \geq 10\text{pF} : \pm 7.5\%$ (C: Nominal capacitance) IR : $500M\Omega \text{ min}$
	High Permittivity (Class2) Note 1		Appearance : No abnormality Cap. Change : Within $\pm 12.5\%$ $\tan \delta$: 5% max IR : Within $25M\Omega \mu\text{F}$ or $500M\Omega$ whichever is smaller.
Test Methods and Remarks	Heat treatment specified in this specification shall be conducted prior to test. No.9 Temperature: 85°C Humidity: 85%RH Duration: 1000hrs Applied voltage: Rated voltage and 1.3 to 1.5V. Measurement shall be performed after test sample following the test is heated at $150+0/-10^\circ\text{C}$ for an hour and kept at room temperature for 24 ± 2 hours. No.9		

14. Temperature Cycle (Thermal Shock)			
Specified Value	Temperature Compensating (Class1)	Standard	Appearance : No abnormality Cap. Change : Within $\pm 3.0\%$ or $\pm 0.3\text{pF}$, whichever is larger. Q : $C < 10\text{pF} : Q \geq 200 + 10C$ $10 \leq C < 30\text{pF} : Q \geq 275 + 2.5C$ $C \geq 30\text{pF} : Q \geq 350$ (C: Nominal capacitance) IR : $1000\text{M}\Omega \text{ min}$
		High Frequency Type	Appearance : No abnormality Cap. Change : Within $\pm 3.0\%$ or $\pm 0.3\text{pF}$, whichever is larger. IR : $1000\text{M}\Omega \text{ min}$
	High Permittivity (Class2) Note 1		Appearance : No abnormality Cap. Change : Within $\pm 12.5\%$ $\tan \delta$: 5% max IR : Within $50\text{M}\Omega/\mu\text{F}$ or $1000\text{M}\Omega$ whichever is smaller.
Test Methods and Remarks	Heat treatment specified in this specification shall be conducted prior to test. No.9 Temperature: Maximum operating temperature Duration: 1000hrs Applied voltage: Rated voltage Measurement shall be performed after test sample following the test is heated at $150 \pm 0 / -10^\circ\text{C}$ for an hour and kept at room temperature for 24 ± 2 hours. No.9		

15. External Visual	
Specified Value	No abnormality
Test Methods and Remarks	Visual inspection shall be performed.

16. Physical Dimension	
Specified Value	Refer to detailed specification
Test Methods and Remarks	Verify physical dimensions to the applicable device specification.

17. Resistance to Solvents	
Specified Value	Appearance : No abnormality Cap. Change : Initial value Q or $\tan \delta$: Initial value IR : Initial value
Test Methods and Remarks	Heat treatment specified in this specification shall be conducted prior to test. No.9 Add Aqueous wash chemical OKEMCLEAN (A 6% concentrated Oakite cleaner) or equivalent.

18. Mechanical Shock	
Specified Value	Appearance : No abnormality Cap. Change : Initial value Q or $\tan \delta$: Initial value IR : Initial value
Test Methods and Remarks	Heat treatment specified in this specification shall be conducted prior to test. No.9 Three shocks in each direction should be applied along 3 mutually perpendicular axes of the test specimen (18 shocks). Peak value: 1500g Duration: 0.5ms Test pulse: Half-sine Velocity change: 4.7m/s.

19. Vibration	
Specified Value	Appearance : No abnormality Cap. Change : Initial value Q or $\tan \delta$: Initial value IR : Initial value
Test Methods and Remarks	Heat treatment specified in this specification shall be conducted prior to test. No.9 5g's for 20 min., 12 cycles each of 3 orientations. (Total: 36 cycles) Frequency range: 10Hz~2000Hz

20. Resistance to Soldering Heat

Specified Value	Temperature Compensating (Class1)	Standard	Appearance : No abnormality Cap. Change : Within $\pm 2.5\%$ or $\pm 0.25\text{pF}$, whichever is larger. Q : Initial value IR : Initial value
		High Frequency Type	Appearance : No abnormality Cap. Change : Within $\pm 2.5\%$ or $\pm 0.25\text{pF}$, whichever is larger. IR : Initial value
	High Permittivity (Class2) Note 1		Appearance : No abnormality Cap. Change : Within $\pm 7.5\%$ $\tan \delta$: Initial value IR : Initial value
Test Methods and Remarks	Heat treatment specified in this specification shall be conducted prior to test. No.9 Dipping Solder: $260 \pm 5^\circ\text{C}$ Time: 10 ± 1 sec. Measurement shall be performed after test sample following the test kept at room temperature for 24 ± 2 hours.		

21. ESC

Specified Value	Appearance: No abnormality IR: Initial value
Test Methods and Remarks	Heat treatment specified in this specification shall be conducted prior to test. No.9 Per AEC-Q200-002

22. Solderability

Specified Value	More than 95% of terminal electrode shall be covered with fresh solder.
Test Methods and Remarks	(a) Pb Free Solder Solder at $235 \pm 5^\circ\text{C}$ for 5sec. (b) SnPb Solder Solder at $215 \pm 5^\circ\text{C}$ for 5sec. (c) Wave Soldering (Pb Free Solder) Solder at $260 \pm 5^\circ\text{C}$ for 7sec.

23. Temperature Characteristic

Specified Value	Temperature Compensating (Class1)	Temp. chara. [ppm/ $^\circ\text{C}$]		Tolerance [ppm/ $^\circ\text{C}$]		
		C□ : 0	CG, CH, CJ, CK	G : ± 30	H : ± 60	
	High Permittivity (Class2)		Capacitance change rate	Reference temperature	Temperature range	
		B5	X5R	$\pm 15\%$	25°C	$-55 \sim +85^\circ\text{C}$
		B7	X7R	$\pm 15\%$	25°C	$-55 \sim +125^\circ\text{C}$
		C6	X6S	$\pm 22\%$	25°C	$-55 \sim +105^\circ\text{C}$
		C7	X7S	$\pm 22\%$	25°C	$-55 \sim +125^\circ\text{C}$
		D7	X7T	$+22 / -33\%$	25°C	$-55 \sim +125^\circ\text{C}$
Test Methods and Remarks	Heat treatment specified in this specification shall be conducted prior to test. No.9 Capacitance shall be measured at room temperature as well as minimum and maximum operating temperatures.					

► This catalog contains the typical specification only due to the limitation of space. When you consider the purchase of our products, please check our specification. For details of each product (characteristics graph, reliability information, precautions for use, and so on), see our Web site (<http://www.ty-top.com/>).

24. Board Flex

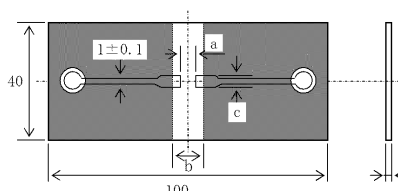
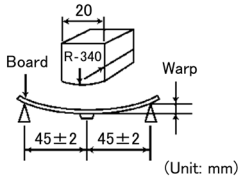
Specified Value	Appearance: No abnormality Cap. Change: $\pm 12.5\%$																																															
Test Methods and Remarks	<p>Heat treatment specified in this specification shall be conducted prior to test. No.9 Test sample is soldered onto the test board shown in Fig 1. The board is bent 2.0mm for 60 seconds as shown in Fig 2. Measurement shall be conducted as the board is bent 2.0mm.</p> <div style="display: flex; justify-content: space-around; align-items: flex-start;"> <div style="text-align: center;">  <p>Fig 1</p> </div> <table border="1" style="border-collapse: collapse; text-align: center;"> <thead> <tr> <th rowspan="2">Dimension</th> <th colspan="7">Case size [mm]</th> </tr> <tr> <th>0603</th> <th>1005</th> <th>1608</th> <th>2012</th> <th>3216</th> <th>3225</th> <th>4532</th> </tr> </thead> <tbody> <tr> <td>a</td> <td>0.3</td> <td>0.4</td> <td>1.0</td> <td>1.2</td> <td>2.2</td> <td>2.2</td> <td>3.5</td> </tr> <tr> <td>b</td> <td>0.9</td> <td>1.5</td> <td>3.0</td> <td>4.0</td> <td>5.0</td> <td>5.0</td> <td>7.0</td> </tr> <tr> <td>c</td> <td>0.3</td> <td>0.5</td> <td>1.2</td> <td>1.65</td> <td>2.0</td> <td>2.9</td> <td>3.7</td> </tr> <tr> <td>Thickness</td> <td colspan="7">0.8</td> </tr> </tbody> </table> </div> <div style="text-align: center; margin-top: 10px;">  <p>Fig 2</p> </div>	Dimension	Case size [mm]							0603	1005	1608	2012	3216	3225	4532	a	0.3	0.4	1.0	1.2	2.2	2.2	3.5	b	0.9	1.5	3.0	4.0	5.0	5.0	7.0	c	0.3	0.5	1.2	1.65	2.0	2.9	3.7	Thickness	0.8						
Dimension	Case size [mm]																																															
	0603	1005	1608	2012	3216	3225	4532																																									
a	0.3	0.4	1.0	1.2	2.2	2.2	3.5																																									
b	0.9	1.5	3.0	4.0	5.0	5.0	7.0																																									
c	0.3	0.5	1.2	1.65	2.0	2.9	3.7																																									
Thickness	0.8																																															

25. Terminal Strength

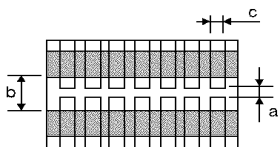
Specified Value	Appearance: No abnormality																																							
Test Methods and Remarks	<p>Per AEC-Q200-006 Test sample is soldered onto the test board shown in Fig 3. 0603 or greater (case size): 17.7N for 60\pm5 sec 0402 (case size): 5N for 30\pm5 sec. 0201 (case size): 2N for 30\pm5 sec.</p> <div style="display: flex; justify-content: space-around; align-items: flex-start;"> <div style="text-align: center;">  <p>Fig 3</p> </div> <table border="1" style="border-collapse: collapse; text-align: center;"> <thead> <tr> <th rowspan="2">Dimension</th> <th colspan="7">Case size [mm]</th> </tr> <tr> <th>0603</th> <th>1005</th> <th>1608</th> <th>2012</th> <th>3216</th> <th>3225</th> <th>4532</th> </tr> </thead> <tbody> <tr> <td>a</td> <td>0.3</td> <td>0.4</td> <td>1.0</td> <td>1.2</td> <td>2.2</td> <td>2.2</td> <td>3.5</td> </tr> <tr> <td>b</td> <td>0.9</td> <td>1.5</td> <td>3.0</td> <td>4.0</td> <td>5.0</td> <td>5.0</td> <td>7.0</td> </tr> <tr> <td>c</td> <td>0.3</td> <td>0.5</td> <td>1.2</td> <td>1.65</td> <td>2.0</td> <td>2.9</td> <td>3.7</td> </tr> </tbody> </table> </div>	Dimension	Case size [mm]							0603	1005	1608	2012	3216	3225	4532	a	0.3	0.4	1.0	1.2	2.2	2.2	3.5	b	0.9	1.5	3.0	4.0	5.0	5.0	7.0	c	0.3	0.5	1.2	1.65	2.0	2.9	3.7
Dimension	Case size [mm]																																							
	0603	1005	1608	2012	3216	3225	4532																																	
a	0.3	0.4	1.0	1.2	2.2	2.2	3.5																																	
b	0.9	1.5	3.0	4.0	5.0	5.0	7.0																																	
c	0.3	0.5	1.2	1.65	2.0	2.9	3.7																																	

26. Beam Load Test

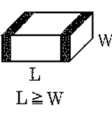
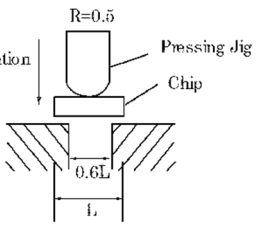
Specified Value	Destruction value should exceed 5N.
Test Methods and Remarks	<p>Per AEC-Q200-003</p> <div style="display: flex; align-items: center;"> <div style="margin-right: 20px;">  </div> <div>  </div> </div>

Note 1 The figures indicate typical specifications. Please refer to individual specifications in detail.

Multilayer Ceramic Capacitors

PRECAUTIONS

1. Circuit Design

- Precautions**
- ◆ Verification of operating environment, electrical rating and performance
 1. A malfunction of equipment in fields such as medical, aerospace, nuclear control, etc. may cause serious harm to human life or have severe social ramifications. Therefore, any capacitors to be used in such equipment may require higher safety and reliability, and shall be clearly differentiated from them used in general purpose applications.
 - ◆ Operating Voltage (Verification of Rated voltage)
 1. The operating voltage for capacitors must always be their rated voltage or less.
 - If an AC voltage is loaded on a DC voltage, the sum of the two peak voltages shall be the rated voltage or less.
 - For a circuit where an AC or a pulse voltage may be used, the sum of their peak voltages shall also be the rated voltage or less.
 2. Even if an applied voltage is the rated voltage or less reliability of capacitors may be deteriorated in case that either a high frequency AC voltage or a pulse voltage having rapid rise time is used in a circuit.

2. PCB Design

- Precautions**
- ◆ Pattern configurations (Design of Land-patterns)
 1. When capacitors are mounted on PCBs, the amount of solder used (size of fillet) can directly affect the capacitor performance. Therefore, the following items must be carefully considered in the design of land patterns:
 - (1) Excessive solder applied can cause mechanical stresses which lead to chip breaking or cracking. Therefore, please consider appropriate land-patterns for proper amount of solder.
 - (2) When more than one component are jointly soldered onto the same land, each component's soldering point shall be separated by solder-resist.
 - ◆ Pattern configurations (Capacitor layout on PCBs)

After capacitors are mounted on boards, they can be subjected to mechanical stresses in subsequent manufacturing processes (PCB cutting, board inspection, mounting of additional parts, assembly into the chassis, wave soldering of the boards, etc.). For this reason, land pattern configurations and positions of capacitors shall be carefully considered to minimize stresses.

Technical considerations

- ◆ Pattern configurations (Design of Land-patterns)

The following diagrams and tables show some examples of recommended land patterns to prevent excessive solder amounts.

(1) Recommended land dimensions for typical chip capacitors

 - Multilayer Ceramic Capacitors : Recommended land dimensions (unit: mm)

Wave-soldering

Type	1608	2012	3216	3225	
Size	L	1.6	2.0	3.2	3.2
	W	0.8	1.25	1.6	2.5
A	0.8 to 1.0	1.0 to 1.4	1.8 to 2.5	1.8 to 2.5	
B	0.5 to 0.8	0.8 to 1.5	0.8 to 1.7	0.8 to 1.7	
C	0.6 to 0.8	0.9 to 1.2	1.2 to 1.6	1.8 to 2.5	

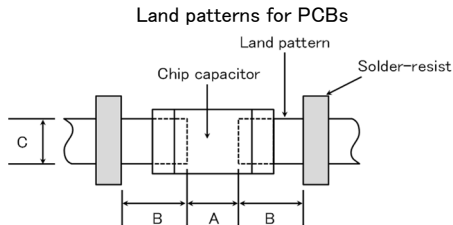

Reflow-soldering

Type	0201	0402	0603	1005	1608	2012	3216	3225	4532
Size	L	0.25	0.4	0.6	1.0	1.6	2.0	3.2	4.5
	W	0.125	0.2	0.3	0.5	0.8	1.25	1.6	3.2
A	0.095~0.135	0.15~0.25	0.20~0.30	0.45~0.55	0.6~0.8	0.8~1.2	1.8~2.5	1.8~2.5	2.5~3.5
B	0.085~0.125	0.10~0.20	0.20~0.30	0.40~0.50	0.6~0.8	0.8~1.2	1.0~1.5	1.0~1.5	1.5~1.8
C	0.110~0.150	0.15~0.30	0.25~0.40	0.45~0.55	0.6~0.8	0.9~1.6	1.2~2.0	1.8~3.2	2.3~3.5

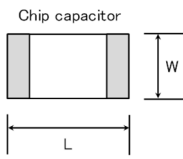

Note: Recommended land size might be different according to the allowance of the size of the product.

 - LWDC: Recommended land dimensions for reflow-soldering (unit: mm)

Type	0510	0816	1220	
Size	L	0.52	0.8	1.25
	W	1.0	1.6	2.0
A	0.18~0.22	0.25~0.3	0.5~0.7	
B	0.2~0.25	0.3~0.4	0.4~0.5	
C	0.9~1.1	1.5~1.7	1.9~2.1	

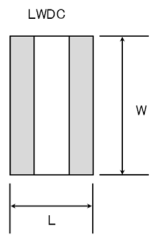

* This catalog contains the typical specification only due to the limitation of space. When you consider the purchase of our products, please check our specification. For details of each product (characteristics graph, reliability information, precautions for use, and so on), see our Web site (<http://www.ty-top.com/>).

(2) Examples of good and bad solder application

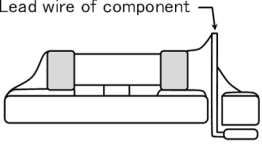
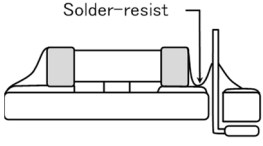
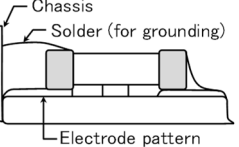
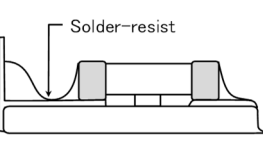
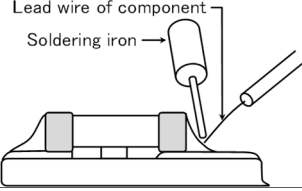
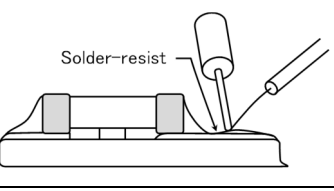
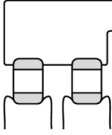
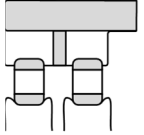
Item	Not recommended	Recommended
Mixed mounting of SMD and leaded components		
Component placement close to the chassis		
Hand-soldering of leaded components near mounted components		
Horizontal component placement		

◆ Pattern configurations (Capacitor layout on PCBs)

1-1. The following is examples of good and bad capacitor layouts ; capacitors shall be located to minimize any possible mechanical stresses from board warp or deflection.

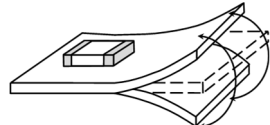
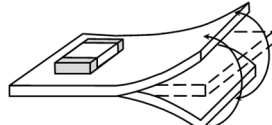
Items	Not recommended	Recommended
Deflection of board		 Place the product at a right angle to the direction of the anticipated mechanical stress.

1-2. The amount of mechanical stresses given will vary depending on capacitor layout. Please refer to diagram below.

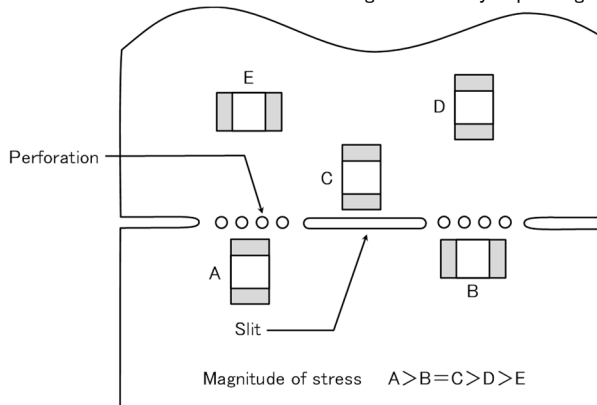

1-3. When PCB is split, the amount of mechanical stress on the capacitors can vary according to the method used. The following methods are listed in order from least stressful to most stressful: push-back, slit, V-grooving, and perforation. Thus, please consider the PCB, split methods as well as chip location.

3. Mounting

Precautions

◆ Adjustment of mounting machine

- When capacitors are mounted on PCB, excessive impact load shall not be imposed on them.
- Maintenance and inspection of mounting machines shall be conducted periodically.

◆ Selection of Adhesives

- When chips are attached on PCBs with adhesives prior to soldering, it may cause capacitor characteristics degradation unless the following factors are appropriately checked : size of land patterns, type of adhesive, amount applied, hardening temperature and hardening period. Therefore, please contact us for further information.

◆ Adjustment of mounting machine

1. When the bottom dead center of a pick-up nozzle is too low, excessive force is imposed on capacitors and causes damages. To avoid this, the following points shall be considerable.
 - (1) The bottom dead center of the pick-up nozzle shall be adjusted to the surface level of PCB without the board deflection.
 - (2) The pressure of nozzle shall be adjusted between 1 and 3 N static loads.
 - (3) To reduce the amount of deflection of the board caused by impact of the pick-up nozzle, supporting pins or back-up pins shall be used on the other side of the PCB. The following diagrams show some typical examples of good and bad pick-up nozzle placement:

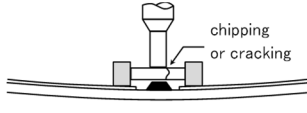
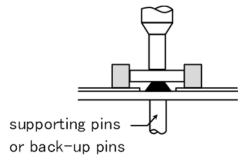
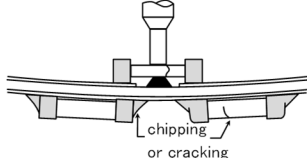
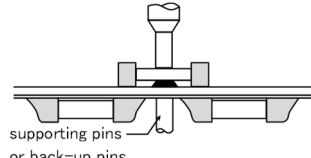
Item	Improper method	Proper method
Single-sided mounting		
Double-sided mounting		

Technical considerations

2. As the alignment pin is worn out, adjustment of the nozzle height can cause chipping or cracking of capacitors because of mechanical impact on the capacitors. To avoid this, the monitoring of the width between the alignment pins in the stopped position, maintenance, check and replacement of the pin shall be conducted periodically.

◆ Selection of Adhesives

Some adhesives may cause IR deterioration. The different shrinkage percentage of between the adhesive and the capacitors may result in stresses on the capacitors and lead to cracking. Moreover, too little or too much adhesive applied to the board may adversely affect components. Therefore, the following precautions shall be noted in the application of adhesives.

- (1) Required adhesive characteristics
 - a. The adhesive shall be strong enough to hold parts on the board during the mounting & solder process.
 - b. The adhesive shall have sufficient strength at high temperatures.
 - c. The adhesive shall have good coating and thickness consistency.
 - d. The adhesive shall be used during its prescribed shelf life.
 - e. The adhesive shall harden rapidly.
 - f. The adhesive shall have corrosion resistance.
 - g. The adhesive shall have excellent insulation characteristics.
 - h. The adhesive shall have no emission of toxic gasses and no effect on the human body.
- (2) The recommended amount of adhesives is as follows:

[Recommended condition]

Figure	2012/3216 case sizes as examples
a	0.3mm min
b	100 to 120 μm
c	Adhesives shall not contact land

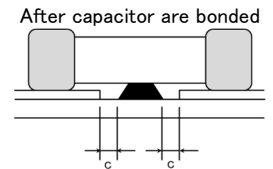
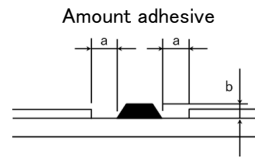

4. Soldering

◆ Selection of Flux

- Since flux may have a significant effect on the performance of capacitors, it is necessary to verify the following conditions prior to use;
- (1) Flux used shall be less than or equal to 0.1 wt% (in Cl equivalent) of halogenated content. Flux having a strong acidity content shall not be applied.
 - (2) When shall capacitors are soldered on boards, the amount of flux applied shall be controlled at the optimum level.
 - (3) When water-soluble flux is used, special care shall be taken to properly clean the boards.

Precautions

◆ Soldering

Temperature, time, amount of solder, etc. shall be set in accordance with their recommended conditions. Sn-Zn solder paste can adversely affect MLCC reliability. Please contact us prior to usage of Sn-Zn solder.

Technical considerations

◆ Selection of Flux

- 1-1. When too much halogenated substance (Chlorine, etc.) content is used to activate flux, or highly acidic flux is used, it may lead to corrosion of terminal electrodes or degradation of insulation resistance on the surfaces of the capacitors.
- 1-2. Flux is used to increase solderability in wave soldering. However if too much flux is applied, a large amount of flux gas may be emitted and may adversely affect the solderability. To minimize the amount of flux applied, it is recommended to use a flux-bubbling system.
- 1-3. Since the residue of water-soluble flux is easily dissolved in moisture in the air, the residues on the surfaces of capacitors in high humidity conditions may cause a degradation of insulation resistance and reliability of the capacitors. Therefore, the cleaning methods

► This catalog contains the typical specification only due to the limitation of space. When you consider the purchase of our products, please check our specification. For details of each product (characteristics graph, reliability information, precautions for use, and so on), see our Web site (<http://www.ty-top.com/>).

and the capability of the machines used shall also be considered carefully when water-soluble flux is used.

◆Soldering

- Ceramic chip capacitors are susceptible to thermal shock when exposed to rapid or concentrated heating or rapid cooling.
- Therefore, the soldering must be conducted with great care so as to prevent malfunction of the components due to excessive thermal shock.
- Preheating : Capacitors shall be preheated sufficiently, and the temperature difference between the capacitors and solder shall be within 130°C.
- Cooling : The temperature difference between the capacitors and cleaning process shall not be greater than 100°C.

[Reflow soldering]

【Recommended conditions for eutectic soldering】

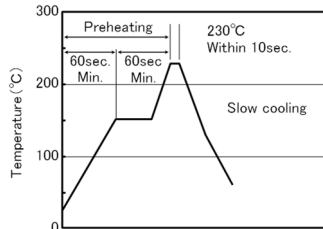

【Recommended condition for Pb-free soldering】

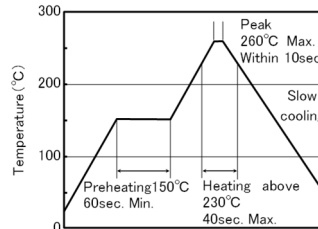

Caution

- ①The ideal condition is to have solder mass (fillet) controlled to 1/2 to 1/3 of the thickness of a capacitor.
- ②Because excessive dwell times can adversely affect solderability, soldering duration shall be kept as close to recommended times as possible. soldering for 2 times.

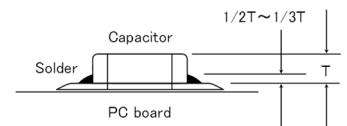

[Wave soldering]

【Recommended conditions for eutectic soldering】

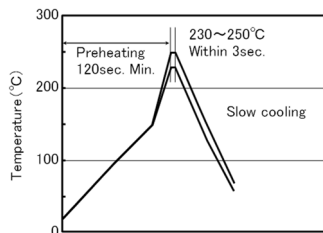

【Recommended condition for Pb-free soldering】

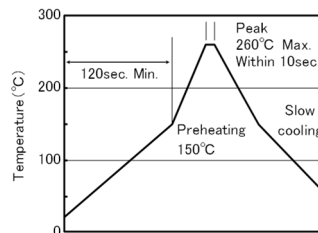

Caution

- ①Wave soldering must not be applied to capacitors designated as for reflow soldering only. soldering for 1 times.

[Hand soldering]

【Recommended conditions for eutectic soldering】

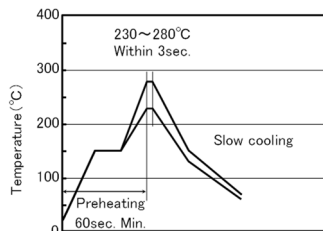

【Recommended condition for Pb-free soldering】

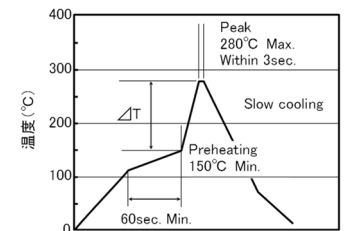
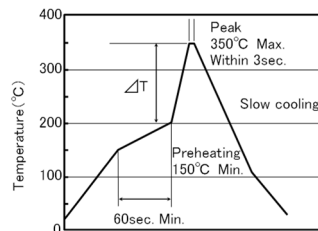

	ΔT
3216type or less	$\Delta T \leq 150^{\circ}\text{C}$

	ΔT
3225type or more	$\Delta T \leq 130^{\circ}\text{C}$

Caution

- ①Use a 50W soldering iron with a maximum tip diameter of 1.0 mm.
- ②The soldering iron shall not directly touch capacitors. soldering for 1 times.

5. Cleaning	
Precautions	<p>◆Cleaning conditions</p> <ol style="list-style-type: none"> When PCBs are cleaned after capacitors mounting, please select the appropriate cleaning solution in accordance with the intended use of the cleaning. (e.g. to remove soldering flux or other materials from the production process.) Cleaning condition shall be determined after it is verified by using actual cleaning machine that the cleaning process does not affect capacitor's characteristics.
Technical considerations	<ol style="list-style-type: none"> The use of inappropriate cleaning solutions can cause foreign substances such as flux residue to adhere to capacitors or deteriorate their outer coating, resulting in a degradation of the capacitor's electrical properties (especially insulation resistance). Inappropriate cleaning conditions (insufficient or excessive cleaning) may adversely affect the performance of the capacitors. In the case of ultrasonic cleaning, too much power output can cause excessive vibration of PCBs which may lead to the cracking of capacitors or the soldered portion, or decrease the terminal electrodes' strength. Therefore, the following conditions shall be carefully checked: Ultrasonic output : 20 W/l or less Ultrasonic frequency : 40 kHz or less Ultrasonic washing period : 5 min. or less

6. Resin coating and mold	
Precautions	<ol style="list-style-type: none"> With some type of resins, decomposition gas or chemical reaction vapor may remain inside the resin during the hardening period or while left under normal storage conditions resulting in the deterioration of the capacitor's performance. When a resin's hardening temperature is higher than capacitor's operating temperature, the stresses generated by the excessive heat may lead to damage or destruction of capacitors. The use of such resins, molding materials etc. is not recommended.

7. Handling	
Precautions	<p>◆Splitting of PCB</p> <ol style="list-style-type: none"> When PCBs are split after components mounting, care shall be taken so as not to give any stresses of deflection or twisting to the board. Board separation shall not be done manually, but by using the appropriate devices. <p>◆Mechanical considerations</p> <p>Be careful not to subject capacitors to excessive mechanical shocks.</p> <ol style="list-style-type: none"> If ceramic capacitors are dropped onto a floor or a hard surface, they shall not be used. Please be careful that the mounted components do not come in contact with or bump against other boards or components.

8. Storage conditions	
Precautions	<p>◆Storage</p> <ol style="list-style-type: none"> To maintain the solderability of terminal electrodes and to keep packaging materials in good condition, care must be taken to control temperature and humidity in the storage area. Humidity should especially be kept as low as possible. <ul style="list-style-type: none"> Recommended conditions Ambient temperature : Below 30°C Humidity : Below 70% RH The ambient temperature must be kept below 40°C. Even under ideal storage conditions, solderability of capacitor is deteriorated as time passes, so capacitors shall be used within 6 months from the time of delivery. <ul style="list-style-type: none"> Ceramic chip capacitors shall be kept where no chlorine or sulfur exists in the air. The capacitance values of high dielectric constant capacitors will gradually decrease with the passage of time, so care shall be taken to design circuits. Even if capacitance value decreases as time passes, it will get back to the initial value by a heat treatment at 150°C for 1hour.
Technical considerations	<p>If capacitors are stored in a high temperature and humidity environment, it might rapidly cause poor solderability due to terminal oxidation and quality loss of taping/packaging materials. For this reason, capacitors shall be used within 6 months from the time of delivery. If exceeding the above period, please check solderability before using the capacitors.</p>

※RCR-2335B (Safety Application Guide for fixed ceramic capacitors for use in electronic equipment) is published by JEITA.

Please check the guide regarding precautions for deflection test, soldering by spot heat, and so on.