

# Multilayer Ceramic Capacitors

## for Medical Devices classified as GHTF Classes A or B (Japan Classes I or II)

REFLOW

## PART NUMBER

M	L	A	S	U	3	1	L	B	B	5	1	0	6	K	T	N	A	0	1
①	②	③	④	⑤	⑥	⑦	⑧	⑨	⑩										

## ① Series

Code (1)(2)(3)(4)	
MLAS	Multilayer Ceramic Capacitor (High dielectric type) for Medical Devices classified as GHTF Classes A or B (Japan Classes I or II) Multilayer Ceramic Capacitor (Temperature compensating type) for Medical Devices classified as GHTF Classes A or B (Japan Classes I or II) Medium-High Voltage Multilayer Ceramic Capacitor for Medical Devices classified as GHTF Classes A or B (Japan Classes I or II)
MLAY	Low distortion design/Audible/Good bias Multilayer Ceramic Capacitor for Medical Devices classified as GHTF Classes A or B (Japan Classes I or II)
MLRL	LW Reversal Decoupling Low ESL Capacitor(LWDC™) for Medical Devices classified as GHTF Classes A or B (Japan Classes I or II)

## (1) Product Group

Code	
M	Multilayer Ceramic Capacitor

## (2) Category

Code	Recommended equipment	Quality Grade
L	Medical Devices classified as GHTF Classes A or B (Japan Classes I or II)	3

## (3) Type

Code	
A	2 terminals
R	LW reversal

## (4) Features, Characteristics

Code	
S	Standard/General
Y	Low distortion design/Audible/Good bias
L	Low ESL

## ② Rated voltage

Code	Rated voltage [VDC]
P	2.5
A	4
J	6.3
L	10
E	16
T	25
G	35
U	50
H	100
Q	250
S	630
X	2000

## ④ Thickness

Code	Thickness [mm]
H	0.13 (1.5 max ※)
E	0.18 (1.1 max ※)
2	0.2
3	0.3
K	0.45
5	0.5
8	0.8
9	0.85
Q	1.15
G	1.25
L	1.6
N	1.9 (0.088 ※)
Y	2.0 max
M	2.5

Note : ※LW reverse type (MLRL)

## ③ Dimension

Code	(L × W) [mm]	JIS(mm)	EIA(inch)
04	0.4 × 0.2	0402	01005
06	0.6 × 0.3	0603	0201
1L	1.0 × 0.5	1005	0402
10	1.0 × 0.5	1005	0402
	0.52 × 1.0 ※	0510	0204
16	1.6 × 0.8	1608	0603
	0.8 × 1.6 ※	0816	0306
21	2.0 × 1.25	2012	0805
	1.25 × 2.0 ※	1220	0508
31	3.2 × 1.6	3216	1206
32	3.2 × 2.5	3225	1210
45	4.5 × 3.2	4532	1812

Note : ※LW reverse type (MLRL)

## ⑤Dimension tolerance

Code	Dimension code	L[mm]	W[mm]	T[mm]	Thickness code
A	06	0.6±0.05	0.3±0.05	0.3±0.05	3
	10	1.0±0.10	0.5±0.10	0.5±0.10	5
	16	1.6+0.15/-0.05	0.8+0.15/-0.05	0.8+0.15/-0.05	8
	21	2.0+0.15/-0.05	1.25+0.15/-0.05	1.25+0.15/-0.05	G
	31	3.2±0.20	1.6±0.20	1.6±0.20	L
	32	3.2±0.30	2.5±0.30	2.5±0.30	M
	45	4.5±0.40	3.2±0.30	2.0+0/-0.30	Y
B	06	0.6±0.09	0.3±0.09	0.3±0.09	3
	10	1.0+0.15/-0.05	0.5+0.15/-0.05	0.5+0.15/-0.05	5
	16	1.6+0.20/-0	0.8+0.20/-0	0.8+0.20/-0	8
	21	2.0+0.20/-0	1.25+0.20/-0	1.25+0.20/-0	G
	31	3.2±0.30	1.6±0.30	1.6±0.30	L
	32	3.2±0.30	2.5±0.20	1.9+0.1/-0.20	Y
C	10	1.0+0.20/-0	0.5+0.20/-0	0.5+0.20/-0	5
E	06	0.6+0.25/-0	0.3+0.25/-0	0.3+0.25/-0	3
H	31	3.2±0.15	1.6±0.15	0.85±0.10	9
				1.15±0.10	Q
J	16	1.6+0.20/-0	0.8+0.20/-0	0.45±0.05	K
	21	2.0+0.15/-0.05	1.25+0.15/-0.05	0.85±0.10	9
	32	3.2±0.30	2.5±0.20	0.85±0.10	9
				1.15±0.10	Q
L	21	2.0+0.20/-0	1.25+0.20/-0	0.85±0.10	9
	31	3.2±0.20	1.6±0.20	0.85±0.10	9
S	04	0.4±0.02	0.2±0.02	0.2±0.02	2
	06	0.6±0.03	0.3±0.03	0.3±0.03	3
	10	1.0±0.05	0.5±0.05	0.5±0.05	5
		0.52±0.05 ※	1.0±0.05	0.3±0.05	3
	16	1.6±0.10	0.8±0.10	0.8±0.10	8
		0.8±0.10 ※	1.6±0.10	0.5±0.05	5
	21	2.0±0.10	1.25±0.10	0.85±0.10	9
				1.25±0.10	G
		1.25±0.15 ※	2.0±0.15	0.85±0.10	9
	31	3.2±0.15	1.6±0.15	1.6±0.20	L
	32	3.2±0.30	2.5±0.20	2.5±0.20	M
			1.9±0.20	N	
45	4.5±0.40	3.2±0.30	2.5±0.20	M	
T	16	1.6±0.10	0.8±0.10	0.45±0.05	K
X	1L	1.0±0.05	0.5±0.05	0.13±0.02	H
				0.18±0.02	E
				0.2±0.02	2
Y	1L	1.0±0.05	0.5±0.05	0.3±0.03	3

Note :※LW reverse type (MLRL)

⑥ Temperature characteristics code

■ High dielectric type (SD: Excluding Low distortion design/Audible/Good bias Multilayer Ceramic Capacitor)

Code	Applicable standard		Temperature range [°C]	Ref. Temp. [°C]	Capacitance change	Capacitance tolerance	Tolerance code
B5	JIS	B	-25 ~ + 85	20	± 10%	± 10%	K
						± 20%	M
	EIA	X5R	-55 ~ + 85	25	± 15%	± 10%	K
						± 20%	M
B7	EIA	X7R	-55 ~ + 125	25	± 15%	± 10%	K
						± 20%	M
C6	EIA	X6S	-55 ~ + 105	25	± 22%	± 10%	K
						± 20%	M
C7	EIA	X7S	-55 ~ + 125	25	± 22%	± 10%	K
						± 20%	M
LD(※)	EIA	X5R	-55 ~ + 85	25	± 15%	± 10%	K
						± 20%	M

Note : ※.LD: Low distortion design/Audible/Good bias Multilayer Ceramic Capacitor

■ Temperature compensating type

Code	Applicable standard		Temperature range [°C]	Ref. Temp. [°C]	Capacitance change	Capacitance tolerance	Tolerance code		
CG	JIS	CG	-55 ~ + 125	20	0 ± 30ppm/°C	± 0.05pF	A		
						± 0.1pF	B		
	± 0.25pF	C							
	± 0.5pF	D							
	EIA	C0G		25		± 5%	J		
	JIS	CH		-55 ~ + 125		20	0 ± 60ppm/°C	± 0.1pF	B
								± 0.25pF	C
EIA	C0H		25			± 0.5pF		D	
						± 5%		J	
CJ	JIS		CJ	-55 ~ + 125		20	0 ± 120ppm/°C	± 0.05pF	A
								± 0.1pF	B
	EIA	C0J			25			± 0.25pF	C
CK	JIS	CK		-55 ~ + 125	20		0 ± 250ppm/°C	± 0.05pF	A
								± 0.1pF	B
	EIA	C0K			25			± 0.25pF	C

⑥ Series code

• Low distortion design/Audible/Good bias Multilayer Ceramic Capacitor

Code	Series code
SD	Standard

• Medium-High Voltage Multilayer Ceramic Capacitor

Code	Series code
SD	Standard

⑦ Nominal capacitance

Code (example)	Nominal capacitance
0R5	0.5pF
010	1pF
100	10pF
101	100pF
102	1,000pF
103	0.01μF
104	0.1μF
105	1μF
106	10μF
107	100μF

Note : R=Decimal point

⑧ Capacitance tolerance

Code	Capacitance tolerance
A	± 0.05pF
B	± 0.1pF
C	± 0.25pF
D	± 0.5pF
G	± 2%
J	± 5%
K	± 10%
M	± 20%

⑨ Packaging

Code	Packaging
F	φ178mm Taping (2mm pitch)
T	φ178mm Taping (4mm pitch)
P	φ178mm Taping (4mm pitch, 1000 pcs/reel) 3225 type (Thickness code M)
R	φ178mm Embossed Taping 1005type (2mm pitch) 1608type (4mm pitch)
W	φ178mm Embossed Taping (1mm pitch) 0402type

⑩ Internal code

## STANDARD EXTERNAL DIMENSIONS

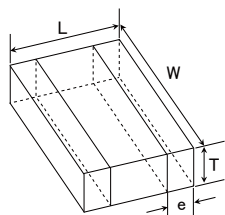
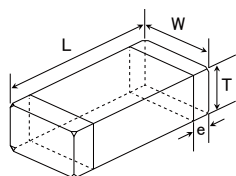

※LW reverse type

Type	JIS (mm)	EIA (inch)	Dimension [mm]				
			L	W	T	*1	e
MLAS□04	0402	01005	$0.4 \pm 0.02$	$0.2 \pm 0.02$	$0.2 \pm 0.02$	2	$0.1 \pm 0.03$
MLAS□06	0603	0201	$0.6 \pm 0.03$	$0.3 \pm 0.03$	$0.3 \pm 0.03$	3	$0.15 \pm 0.05$
MLAS□1L	1005	0402	$1.0 \pm 0.05$	$0.5 \pm 0.05$	$0.13 \pm 0.02$	H	$0.25 \pm 0.10$
					$0.18 \pm 0.02$	E	
					$0.2 \pm 0.02$	2	
					$0.3 \pm 0.03$	3	
MLAS□10	1005	0402	$1.0 \pm 0.05$	$0.5 \pm 0.05$	$0.5 \pm 0.05$	5	$0.25 \pm 0.10$
MLAY□1L	1005	0402	$1.0 \pm 0.05$	$0.5 \pm 0.05$	$0.3 \pm 0.03$	3	$0.25 \pm 0.10$
MLAY□10	1005	0402	$1.0 \pm 0.05$	$0.5 \pm 0.05$	$0.5 \pm 0.05$	5	$0.25 \pm 0.10$
MLRL□10 ※	0510	0204	$0.52 \pm 0.05$	$1.0 \pm 0.05$	$0.3 \pm 0.05$	3	$0.18 \pm 0.08$
MLAS□16	1608	0603	$1.6 \pm 0.10$	$0.8 \pm 0.10$	$0.45 \pm 0.05$	K	$0.35 \pm 0.25$
					$0.8 \pm 0.10$	8	
MLAY□16	1608	0603	$1.6 \pm 0.10$	$0.8 \pm 0.10$	$0.8 \pm 0.10$	8	$0.35 \pm 0.25$
MLRL□16 ※	0816	0306	$0.8 \pm 0.10$	$1.6 \pm 0.10$	$0.5 \pm 0.05$	5	$0.25 \pm 0.15$
MLAS□21	2012	0805	$2.0 \pm 0.10$	$1.25 \pm 0.10$	$0.85 \pm 0.10$	9	$0.5 \pm 0.25$
MLAY□21					$1.25 \pm 0.10$	G	
MLRL□21 ※	1220	0508	$1.25 \pm 0.15$	$2.0 \pm 0.15$	$0.85 \pm 0.10$	9	$0.3 \pm 0.2$
MLAS□31	3216	1206	$3.2 \pm 0.15$	$1.6 \pm 0.15$	$0.85 \pm 0.10$	9	$0.5 + 0.35 / - 0.25$
					$1.15 \pm 0.10$	Q	
					$1.6 \pm 0.20$	L	
MLAY□31	3216	1206	$3.2 \pm 0.15$	$1.6 \pm 0.15$	$1.15 \pm 0.10$	Q	$0.5 + 0.35 / - 0.25$
					$1.6 \pm 0.20$	L	
					$0.85 \pm 0.10$	9	
MLAS□32	3225	1210	$3.2 \pm 0.30$	$2.5 \pm 0.20$	$1.15 \pm 0.10$	Q	$0.6 \pm 0.3$
					$1.9 \pm 0.20$	N	
					$1.9 + 0.1 / - 0.20$	Y	
					$2.5 \pm 0.20$	M	
MLAY□32	3225	1210	$3.2 \pm 0.30$	$2.5 \pm 0.20$	$1.9 \pm 0.20$	N	$0.6 \pm 0.3$
					$2.5 \pm 0.20$	M	
					$2.0 + 0 / - 0.30$	Y	
MLAS□45	4532	1812	$4.5 \pm 0.40$	$3.2 \pm 0.30$	$2.0 + 0 / - 0.30$	Y	$0.6 \pm 0.4$
					$2.5 \pm 0.20$	M	

Note :※LW reverse type (MLRL), \*1.Thickness code

## ■ STANDARD QUANTITY

Type			Thickness		Standard quantity [pcs]	
Code	JIS(mm)	EIA(inch)	[mm]	Code	Paper tape	Embossed tape
04	0402	01005	0.2	2	—	40000
06	0603	0201	0.3	3	15000	—
1L	1005	0402	0.13	H	—	20000
			0.18	E	—	15000
			0.2	2	20000	—
			0.3	3	15000	—
10	1005	0402	0.5	5	10000	—
	0510 ※	0204 ※	0.3	3		
16	1608	0603	0.45	K	4000	—
			0.8	8		
	0816 ※	0306 ※	0.5	5	—	4000
21	2012	0805	0.85	9	4000	—
			1.25	G	—	3000
	1220 ※	0508 ※	0.85	9	4000	—
31	3216	1206	0.85	9	4000	—
			1.15	Q	—	3000
			1.6	L	—	2000
32	3225	1210	0.85	9	—	2000
			1.15	Q		
			1.9	N		
			2.0 max	Y		
			2.5	M		
45	4532	1812	2.0 max	Y	—	1000
			2.5	M	—	500

Note : ※.LW Reverse type (MLRL)

■ PARTS NUMBER

- All the Multilayer Ceramic Capacitors of the catalog lineup are RoHS Compliant.
- Capacitance tolerance code is applied to □ of part number.
- All the Multilayer Ceramic Capacitors in the catalog lineup are applicable for reflow-soldering. Please contact us for flow compatible products.

Note)  
 \*1 We may provide X7R/X7S for some items according to the individual specification.  
 \*2 The exchange of individual specification is necessary depending on the application and circuit condition. Please contact TAIYO YUDEN sales channels.  
 \*3 The size standard should look at Dimension, Thickness, Dimension tolerance, and STANDARD EXTERNAL DIMENSIONS.

**Multilayer Ceramic Capacitors (High dielectric type) for Medical Devices classified as GHTF Classes A or B (Japan Classes I or II)**

● 0402TYPE

【Temperature Characteristic B5(BJ): B (-25~+85°C)/X5R(-55~+85°C)】 0.2mm thickness

New part number	Old part number (for reference)	Rated voltage [V]	Temperature characteristics	Capacitance [F]	Capacitance tolerance [%]	tan δ [%]	HTLT	Thickness*3 [mm]	Note
							Rated voltage x %		
MLASE042SB5101□WNA01	EMK042 BJ101□C-W	16	X5R	100 p	±10, ±20	5	200	0.2±0.02	
MLASE042SB5151□WNA01	EMK042 BJ151□C-W	16	X5R	150 p	±10, ±20	5	200	0.2±0.02	
MLASE042SB5221□WNA01	EMK042 BJ221□C-W	16	X5R	220 p	±10, ±20	5	200	0.2±0.02	
MLASE042SB5331□WNA01	EMK042 BJ331□C-W	16	X5R	330 p	±10, ±20	5	200	0.2±0.02	
MLASE042SB5471□WNA01	EMK042 BJ471□C-W	16	X5R	470 p	±10, ±20	5	200	0.2±0.02	
MLASE042SB5681□WNA01	EMK042 BJ681□C-W	16	X5R	680 p	±10, ±20	5	200	0.2±0.02	
MLASE042SB5102□WNA01	EMK042 BJ102□C-W	16	B X5R	1000 p	±10, ±20	5	200	0.2±0.02	
MLASE042SB5152□WNA01	EMK042 BJ152□C-W	16	X5R	1500 p	±10, ±20	10	150	0.2±0.02	
MLASE042SB5222□WNA01	EMK042 BJ222□C-W	16	X5R	2200 p	±10, ±20	10	150	0.2±0.02	
MLASE042SB5332□WNA01	EMK042 BJ332□C-W	16	X5R	3300 p	±10, ±20	10	150	0.2±0.02	
MLASE042SB5472□WNA01	EMK042 BJ472□C-W	16	X5R	4700 p	±10, ±20	10	150	0.2±0.02	
MLASE042SB5682□WNA01	EMK042 BJ682□C-W	16	X5R	6800 p	±10, ±20	10	150	0.2±0.02	
MLASE042SB5103□WNA01	EMK042 BJ103□C-W	16	X5R	0.01 μ	±10, ±20	10	150	0.2±0.02	
MLASL042SB5101□WNA01	LМК042 BJ101□C-W	10	X5R*1	100 p	±10, ±20	5	200	0.2±0.02	
MLASL042SB5151□WNA01	LМК042 BJ151□C-W	10	X5R*1	150 p	±10, ±20	5	200	0.2±0.02	
MLASL042SB5221□WNA01	LМК042 BJ221□C-W	10	X5R*1	220 p	±10, ±20	5	200	0.2±0.02	
MLASL042SB5331□WNA01	LМК042 BJ331□C-W	10	X5R*1	330 p	±10, ±20	5	200	0.2±0.02	
MLASL042SB5471□WNA01	LМК042 BJ471□C-W	10	X5R*1	470 p	±10, ±20	5	200	0.2±0.02	
MLASL042SB5681□WNA01	LМК042 BJ681□C-W	10	X5R*1	680 p	±10, ±20	5	200	0.2±0.02	
MLASL042SB5102□WNA01	LМК042 BJ102□C-W	10	B X5R*1	1000 p	±10, ±20	5	200	0.2±0.02	
MLASL042SB5152□WNA01	LМК042 BJ152□C-W	10	X5R	1500 p	±10, ±20	10	150	0.2±0.02	
MLASL042SB5222□WNA01	LМК042 BJ222□C-W	10	X5R	2200 p	±10, ±20	10	150	0.2±0.02	
MLASL042SB5332□WNA01	LМК042 BJ332□C-W	10	X5R	3300 p	±10, ±20	10	150	0.2±0.02	
MLASL042SB5472□WNA01	LМК042 BJ472□C-W	10	X5R	4700 p	±10, ±20	10	150	0.2±0.02	
MLASL042SB5682□WNA01	LМК042 BJ682□C-W	10	X5R	6800 p	±10, ±20	10	150	0.2±0.02	
MLASL042SB5103□WNA01	LМК042 BJ103□C-W	10	X5R	0.01 μ	±10, ±20	10	150	0.2±0.02	
MLASJ042SB5152□WNA01	JMK042 BJ152□C-W	6.3	X5R*1	1500 p	±10, ±20	10	150	0.2±0.02	
MLASJ042SB5222□WNA01	JMK042 BJ222□C-W	6.3	X5R*1	2200 p	±10, ±20	10	150	0.2±0.02	
MLASJ042SB5332□WNA01	JMK042 BJ332□C-W	6.3	X5R*1	3300 p	±10, ±20	10	150	0.2±0.02	
MLASJ042SB5472□WNA01	JMK042 BJ472□C-W	6.3	X5R*1	4700 p	±10, ±20	10	150	0.2±0.02	
MLASJ042SB5682□WNA01	JMK042 BJ682□C-W	6.3	X5R*1	6800 p	±10, ±20	10	150	0.2±0.02	
MLASJ042SB5103□WNA01	JMK042 BJ103□C-W	6.3	X5R*1	0.01 μ	±10, ±20	10	150	0.2±0.02	
MLASJ042SB5223□WNA01	JMK042 BJ223□C-W	6.3	X5R	0.022 μ	±10, ±20	10	150	0.2±0.02	
MLASJ042SB5473□WNA01	JMK042 BJ473□C-W	6.3	X5R	0.047 μ	±10, ±20	10	150	0.2±0.02	
MLASJ042SB5104□WNA01	JMK042 BJ104□C-W	6.3	X5R	0.1 μ	±10, ±20	10	150	0.2±0.02	
MLASA042SB5473□WNA01	AMK042 BJ473□C-W	4	X5R	0.047 μ	±10, ±20	10	150	0.2±0.02	
MLASA042SB5104□WNA01	AMK042 BJ104□C-W	4	X5R	0.1 μ	±10, ±20	10	150	0.2±0.02	

【Temperature Characteristic B7 : X7R(-55~+125°C)】 0.2mm thickness

New part number	Old part number (for reference)	Rated voltage [V]	Temperature characteristics	Capacitance [F]	Capacitance tolerance [%]	tan δ [%]	HTLT	Thickness*3 [mm]	Note
							Rated voltage x %		
MLASE042SB7101□WNA01	EMK042 B7101□C-W	16	X7R	100 p	±10, ±20	5	200	0.2±0.02	
MLASE042SB7151□WNA01	EMK042 B7151□C-W	16	X7R	150 p	±10, ±20	5	200	0.2±0.02	
MLASE042SB7221□WNA01	EMK042 B7221□C-W	16	X7R	220 p	±10, ±20	5	200	0.2±0.02	
MLASE042SB7331□WNA01	EMK042 B7331□C-W	16	X7R	330 p	±10, ±20	5	200	0.2±0.02	
MLASE042SB7471□WNA01	EMK042 B7471□C-W	16	X7R	470 p	±10, ±20	5	200	0.2±0.02	
MLASE042SB7681□WNA01	EMK042 B7681□C-W	16	X7R	680 p	±10, ±20	5	200	0.2±0.02	
MLASE042SB7102□WNA01	EMK042 B7102□C-W	16	X7R	1000 p	±10, ±20	5	200	0.2±0.02	
MLASL042SB7101□WNA01	LМК042 B7101□C-W	10	X7R	100 p	±10, ±20	5	200	0.2±0.02	
MLASL042SB7151□WNA01	LМК042 B7151□C-W	10	X7R	150 p	±10, ±20	5	200	0.2±0.02	
MLASL042SB7221□WNA01	LМК042 B7221□C-W	10	X7R	220 p	±10, ±20	5	200	0.2±0.02	
MLASL042SB7331□WNA01	LМК042 B7331□C-W	10	X7R	330 p	±10, ±20	5	200	0.2±0.02	
MLASL042SB7471□WNA01	LМК042 B7471□C-W	10	X7R	470 p	±10, ±20	5	200	0.2±0.02	
MLASL042SB7681□WNA01	LМК042 B7681□C-W	10	X7R	680 p	±10, ±20	5	200	0.2±0.02	
MLASL042SB7102□WNA01	LМК042 B7102□C-W	10	X7R	1000 p	±10, ±20	5	200	0.2±0.02	

▶ This catalog contains the typical specification only due to the limitation of space. When you consider the purchase of our products, please check our specification.  
 For details of each product (characteristics graph, reliability information, precautions for use, and so on), see our Web site (<http://www.ty-top.com/>).

## PARTS NUMBER

## 0603TYPE

【Temperature Characteristic B5(BJ): B(-25~+85°C)/X5R(-55~+85°C)】 0.3mm thickness

New part number	Old part number (for reference)	Rated voltage [V]	Temperature characteristics		Capacitance [F]	Capacitance tolerance [%]	tan δ [%]	HTLT	Thickness*3 [mm]	Note
								Rated voltage x %		
MLASU063SB5101[FNA01]	UMK063 BJ101[P-F]	50	B	X5R <sup>+</sup>	100 p	±10, ±20	3.5	200	0.3±0.03	
MLASU063SB5151[FNA01]	UMK063 BJ151[P-F]	50	B	X5R <sup>+</sup>	150 p	±10, ±20	3.5	200	0.3±0.03	
MLASU063SB5221[FNA01]	UMK063 BJ221[P-F]	50	B	X5R <sup>+</sup>	220 p	±10, ±20	3.5	200	0.3±0.03	
MLASU063SB5331[FNA01]	UMK063 BJ331[P-F]	50	B	X5R <sup>+</sup>	330 p	±10, ±20	3.5	200	0.3±0.03	
MLASU063SB5471[FNA01]	UMK063 BJ471[P-F]	50	B	X5R <sup>+</sup>	470 p	±10, ±20	3.5	200	0.3±0.03	
MLASU063SB5681[FNA01]	UMK063 BJ681[P-F]	50	B	X5R <sup>+</sup>	680 p	±10, ±20	3.5	200	0.3±0.03	
MLASU063SB5102[FNA01]	UMK063 BJ102[P-F]	50	B	X5R <sup>+</sup>	1000 p	±10, ±20	3.5	200	0.3±0.03	
MLASU063SB5152[FNA01]	UMK063 BJ152[P-F]	50	B	X5R	1500 p	±10, ±20	5	200	0.3±0.03	
MLASU063SB5222[FNA01]	UMK063 BJ222[P-F]	50	B	X5R	2200 p	±10, ±20	5	200	0.3±0.03	
MLASU063SB5332[FNA01]	UMK063 BJ332[P-F]	50	B	X5R	3300 p	±10, ±20	5	200	0.3±0.03	
MLASU063SB5472[FNA01]	UMK063 BJ472[P-F]	50	B	X5R	4700 p	±10, ±20	5	200	0.3±0.03	
MLASU063SB5682[FNA01]	UMK063 BJ682[P-F]	50	B	X5R	6800 p	±10, ±20	5	200	0.3±0.03	
MLASU063SB5103[FNA01]	UMK063 BJ103[P-F]	50	B	X5R	0.01 μ	±10, ±20	5	200	0.3±0.03	
MLASG063SB5104[FNA01]	GMK063 BJ104[P-F]	35		X5R	0.1 μ	±10, ±20	10	150	0.3±0.03	
MLAST063SB5152[FNA01]	TMK063 BJ152[P-F]	25	B	X5R	1500 p	±10, ±20	5	200	0.3±0.03	
MLAST063SB5222[FNA01]	TMK063 BJ222[P-F]	25	B	X5R	2200 p	±10, ±20	5	200	0.3±0.03	
MLAST063SB5332[FNA01]	TMK063 BJ332[P-F]	25	B	X5R	3300 p	±10, ±20	5	200	0.3±0.03	
MLAST063SB5472[FNA01]	TMK063 BJ472[P-F]	25	B	X5R	4700 p	±10, ±20	5	200	0.3±0.03	
MLAST063SB5682[FNA01]	TMK063 BJ682[P-F]	25	B	X5R	6800 p	±10, ±20	5	200	0.3±0.03	
MLAST063SB5103[FNA01]	TMK063 BJ103[P-F]	25	B	X5R	0.01 μ	±10, ±20	5	200	0.3±0.03	
MLAST063SB5223[FNA01]	TMK063 BJ223[P-F]	25	B	X5R	0.022 μ	±10, ±20	7.5	200	0.3±0.03	
MLAST063AB5104[FNA01]	TMK063ABJ104[P-F]	25		X5R	0.1 μ	±10, ±20	10	150	0.3±0.05	
MLASE063SB5152[FNA01]	EMK063 BJ152[P-F]	16	B	X5R <sup>+</sup>	1500 p	±10, ±20	5	200	0.3±0.03	
MLASE063SB5222[FNA01]	EMK063 BJ222[P-F]	16	B	X5R <sup>+</sup>	2200 p	±10, ±20	5	200	0.3±0.03	
MLASE063SB5332[FNA01]	EMK063 BJ332[P-F]	16	B	X5R <sup>+</sup>	3300 p	±10, ±20	5	200	0.3±0.03	
MLASE063SB5472[FNA01]	EMK063 BJ472[P-F]	16	B	X5R <sup>+</sup>	4700 p	±10, ±20	5	200	0.3±0.03	
MLASE063SB5682[FNA01]	EMK063 BJ682[P-F]	16	B	X5R <sup>+</sup>	6800 p	±10, ±20	5	200	0.3±0.03	
MLASE063SB5103[FNA01]	EMK063 BJ103[P-F]	16	B	X5R <sup>+</sup>	0.01 μ	±10, ±20	5	200	0.3±0.03	
MLASE063SB5153[FNA01]	EMK063 BJ153[P-F]	16		X5R	0.015 μ	±10, ±20	7.5	200	0.3±0.03	
MLASE063SB5223[FNA01]	EMK063 BJ223[P-F]	16	B	X5R	0.022 μ	±10, ±20	7.5	200	0.3±0.03	
MLASE063SB5333[FNA01]	EMK063 BJ333[P-F]	16		X5R	0.033 μ	±10, ±20	7.5	150	0.3±0.03	
MLASE063SB5473[FNA01]	EMK063 BJ473[P-F]	16		X5R	0.047 μ	±10, ±20	7.5	150	0.3±0.03	
MLASE063SB5683[FNA01]	EMK063 BJ683[P-F]	16		X5R	0.068 μ	±10, ±20	10	150	0.3±0.03	
MLASE063SB5104[FNA01]	EMK063 BJ104[P-F]	16		X5R	0.1 μ	±10, ±20	10	150	0.3±0.03	
MLASE063SB5224[FNA01]	EMK063 BJ224[P-F]	16		X5R	0.22 μ	±10, ±20	10	150	0.3±0.03	
MLASE063BB5474[FNB33]	EMK063BBJ474[PLF]	16		X5R	0.47 μ	±10, ±20	10	150	0.3±0.09	
MLASL063SB5223[FNA01]	LMK063 BJ223[P-F]	10	B	X5R	0.022 μ	±10, ±20	7.5	150	0.3±0.03	
MLASL063SB5333[FNA01]	LMK063 BJ333[P-F]	10		X5R	0.033 μ	±10, ±20	7.5	150	0.3±0.03	
MLASL063SB5473[FNA01]	LMK063 BJ473[P-F]	10		X5R	0.047 μ	±10, ±20	7.5	150	0.3±0.03	
MLASL063SB5683[FNA01]	LMK063 BJ683[P-F]	10		X5R	0.068 μ	±10, ±20	10	150	0.3±0.03	
MLASL063SB5104[FNA01]	LMK063 BJ104[P-F]	10		X5R	0.1 μ	±10, ±20	10	150	0.3±0.03	
MLASL063SB5224[FNA01]	LMK063 BJ224[P-F]	10		X5R	0.22 μ	±10, ±20	10	150	0.3±0.03	
MLASL063BB5474[FNB33]	LMK063BBJ474[PLF]	10		X5R	0.47 μ	±10, ±20	10	150	0.3±0.09	
MLASL063BB5105MFNB33	LMK063BBJ105MPLF	10		X5R	1 μ	±20	10	150	0.3±0.09	
MLASJ063SB5104[FNA01]	JMK063 BJ104[P-F]	6.3		X5R	0.1 μ	±10, ±20	10	150	0.3±0.03	
MLASJ063SB5224[FNA01]	JMK063 BJ224[P-F]	6.3		X5R	0.22 μ	±10, ±20	10	150	0.3±0.03	
MLASJ063SB5334MFNA01	JMK063 BJ334MP-F	6.3		X5R	0.33 μ	±20	10	150	0.3±0.03	
MLASJ063SB5474[FNA01]	JMK063 BJ474[P-F]	6.3		X5R	0.47 μ	±10, ±20	10	150	0.3±0.03	
MLASJ063AB5105[FNA01]	JMK063ABJ105[P-F]	6.3		X5R	1 μ	±10, ±20	10	150	0.3±0.05	
MLASP063EB5475MFNA01	PMK063EBJ475MP-F	2.5		X5R	4.7 μ	±20	10	150	0.3+0.25/-0	

【Temperature Characteristic C6 : X6S(-55~+105°C)】 0.3mm thickness

New part number	Old part number (for reference)	Rated voltage [V]	Temperature characteristics		Capacitance [F]	Capacitance tolerance [%]	tan δ [%]	HTLT	Thickness*3 [mm]	Note
								Rated voltage x %		
MLAST063SC6104[FNA01]	TMK063 C6104[P-F]	25		X6S	0.1 μ	±10, ±20	10	150	0.3±0.03	
MLASE063AC6104[FNA01]	EMK063AC6104[P-F]	16		X6S	0.1 μ	±10, ±20	10	150	0.3±0.05	
MLASL063SC6104[FNA01]	LMK063 C6104[P-F]	10		X6S	0.1 μ	±10, ±20	10	150	0.3±0.03	
MLASL063SC6224[FNA01]	LMK063 C6224[P-F]	10		X6S	0.22 μ	±10, ±20	10	150	0.3±0.03	
MLASL063BC6474[FNB33]	LMK063BC6474[PLF]	10		X6S	0.47 μ	±10, ±20	10	150	0.3±0.09	
MLASJ063SC6104[FNA01]	JMK063 C6104[P-F]	6.3		X6S	0.1 μ	±10, ±20	10	150	0.3±0.03	
MLASJ063SC6224[FNA01]	JMK063 C6224[P-F]	6.3		X6S	0.22 μ	±10, ±20	10	150	0.3±0.03	
MLASJ063BC6474[FNA01]	JMK063BC6474[P-F]	6.3		X6S	0.47 μ	±10, ±20	10	150	0.3±0.09	
MLASJ063BC6105MFNA01	JMK063BC6105MP-F	6.3		X6S	1 μ	±20	10	150	0.3±0.09	
MLASA063SC6474[FNA01]	AMK063 C6474[P-F]	4		X6S	0.47 μ	±10, ±20	10	150	0.3±0.03	
MLASA063AC6105[FNA01]	AMK063AC6105[P-F]	4		X6S	1 μ	±10, ±20	10	150	0.3±0.05	

## PARTS NUMBER

## 【Temperature Characteristic B7 : X7R (−55~+125°C)】 0.3mm thickness

New part number	Old part number (for reference)	Rated voltage [V]	Temperature characteristics	Capacitance [F]	Capacitance tolerance [%]	tan δ [%]	HTLT	Thickness*3 [mm]	Note
							Rated voltage x %		
MLASU063SB7101□FNA01	UMK063 B7101□P-F	50	X7R	100 p	±10, ±20	3.5	200	0.3±0.03	
MLASU063SB7151□FNA01	UMK063 B7151□P-F	50	X7R	150 p	±10, ±20	3.5	200	0.3±0.03	
MLASU063SB7221□FNA01	UMK063 B7221□P-F	50	X7R	220 p	±10, ±20	3.5	200	0.3±0.03	
MLASU063SB7331□FNA01	UMK063 B7331□P-F	50	X7R	330 p	±10, ±20	3.5	200	0.3±0.03	
MLASU063SB7471□FNA01	UMK063 B7471□P-F	50	X7R	470 p	±10, ±20	3.5	200	0.3±0.03	
MLASU063SB7681□FNA01	UMK063 B7681□P-F	50	X7R	680 p	±10, ±20	3.5	200	0.3±0.03	
MLASU063SB7102□FNA01	UMK063 B7102□P-F	50	X7R	1000 p	±10, ±20	3.5	200	0.3±0.03	
MLAST063SB7152□FNA01	TMK063 B7152□P-F	25	X7R	1500 p	±10, ±20	5	200	0.3±0.03	
MLAST063SB7222□FNA01	TMK063 B7222□P-F	25	X7R	2200 p	±10, ±20	5	200	0.3±0.03	
MLAST063SB7332□FNA01	TMK063 B7332□P-F	25	X7R	3300 p	±10, ±20	5	200	0.3±0.03	
MLAST063SB7472□FNA01	TMK063 B7472□P-F	25	X7R	4700 p	±10, ±20	5	200	0.3±0.03	
MLAST063SB7682□FNA01	TMK063 B7682□P-F	25	X7R	6800 p	±10, ±20	5	200	0.3±0.03	
MLAST063SB7103□FNA01	TMK063 B7103□P-F	25	X7R	0.01 μ	±10, ±20	5	200	0.3±0.03	
MLASE063SB7152□FNA01	EMK063 B7152□P-F	16	X7R	1500 p	±10, ±20	5	200	0.3±0.03	
MLASE063SB7222□FNA01	EMK063 B7222□P-F	16	X7R	2200 p	±10, ±20	5	200	0.3±0.03	
MLASE063SB7332□FNA01	EMK063 B7332□P-F	16	X7R	3300 p	±10, ±20	5	200	0.3±0.03	
MLASE063SB7472□FNA01	EMK063 B7472□P-F	16	X7R	4700 p	±10, ±20	5	200	0.3±0.03	
MLASE063SB7682□FNA01	EMK063 B7682□P-F	16	X7R	6800 p	±10, ±20	5	200	0.3±0.03	
MLASE063SB7103□FNA01	EMK063 B7103□P-F	16	X7R	0.01 μ	±10, ±20	5	200	0.3±0.03	
MLASE063SB7223□FNA01	EMK063 B7223□P-F	16	X7R	0.022 μ	±10, ±20	7.5	150	0.3±0.03	

## ● 1005TYPE

## 【Temperature Characteristic B5(BJ): B (−25~+85°C)/X5R (−55~+85°C)】 0.5mm thickness

New part number	Old part number (for reference)	Rated voltage [V]	Temperature characteristics	Capacitance [F]	Capacitance tolerance [%]	tan δ [%]	HTLT	Thickness*3 [mm]	Note	
							Rated voltage x %			
MLASU105SB5223□FNA01	UMK105 BJ223□V-F	50	X5R	0.022 μ	±10, ±20	5	200	0.5±0.05		
MLASU105SB5473□FNA01	UMK105 BJ473□V-F	50	X5R	0.047 μ	±10, ±20	5	200	0.5±0.05		
MLASU105SB5104□FNA01	UMK105 BJ104□V-F	50	X5R	0.1 μ	±10, ±20	10	150	0.5±0.05		
MLASU105SB5224□FNA01	UMK105 BJ224□V-F	50	X5R	0.22 μ	±10, ±20	10	150	0.5±0.05		
MLASU105AB5474□FNA01	UMK105ABJ474□V-F	50	X5R	0.47 μ	±10, ±20	10	150	0.5±0.10		
MLASU105CB5105□FNA01	UMK105CBJ105□V-F	50	X5R	1 μ	±10, ±20	10	150	0.5±0.20/-0		
MLASG105SB5104□FNA01	GMK105 BJ104□V-F	35	B	0.1 μ	±10, ±20	5	150	0.5±0.05		
MLASG105AB5105□FNA01	GMK105ABJ105□V-F	35	X5R	1 μ	±10, ±20	10	150	0.5±0.10		
MLAST105SB5153□FNA01	TMK105 BJ153□V-F	25	B	X5R*1	0.015 μ	±10, ±20	3.5	200	0.5±0.05	
MLAST105SB5223□FNA01	TMK105 BJ223□V-F	25	B	X5R*1	0.022 μ	±10, ±20	3.5	200	0.5±0.05	
MLAST105SB5333□FNA01	TMK105 BJ333□V-F	25	B	X5R*1	0.033 μ	±10, ±20	3.5	150	0.5±0.05	
MLAST105SB5473□FNA01	TMK105 BJ473□V-F	25	B	X5R*1	0.047 μ	±10, ±20	3.5	150	0.5±0.05	
MLAST105SB5104□FNA01	TMK105 BJ104□V-F	25	B	X5R	0.1 μ	±10, ±20	5	150	0.5±0.05	
MLAST105SB5224□FNA01	TMK105 BJ224□V-F	25	X5R	0.22 μ	±10, ±20	10	200	0.5±0.05		
MLAST105AB5474□FNA01	TMK105ABJ474□V-F	25	X5R	0.47 μ	±10, ±20	10	200	0.5±0.10		
MLAST105SB5105□FNA01	TMK105 BJ105□V-F	25	X5R	1 μ	±10, ±20	10	150	0.5±0.05		
MLAST105CB5225□FNA01	TMK105CBJ225□V-F	25	X5R	2.2 μ	±10, ±20	10	150	0.5±0.20/-0		
MLASE105SB5224□FNA01	EMK105 BJ224□V-F	16	B	X5R	0.22 μ	±10, ±20	5	150	0.5±0.05	
MLASE105AB5474□FNA01	EMK105ABJ474□V-F	16	X5R	0.47 μ	±10, ±20	10	200	0.5±0.10		
MLASE105SB5105□FNA01	EMK105 BJ105□V-F	16	X5R	1 μ	±10, ±20	10	150	0.5±0.05		
MLASE105AB5225□FNA01	EMK105ABJ225□V-F	16	X5R	2.2 μ	±10, ±20	10	150	0.5±0.10		
MLASL105SB5225□FNA01	LKM105 BJ225□V-F	10	X5R	2.2 μ	±10, ±20	10	150	0.5±0.05		
MLASL105BB5475MFB33	LKM105BBJ475MFLF	10	X5R	4.7 μ	±20	10	150	0.5±0.15/-0.05		
MLASJ105SB5225□FNA01	JMK105 BJ225□V-F	6.3	X5R	2.2 μ	±10, ±20	10	150	0.5±0.05		
MLASJ105BB5475MFA01	JMK105BBJ475MV-F	6.3	X5R	4.7 μ	±20	10	150	0.5±0.15/-0.05		

## 【Temperature Characteristic B5(BJ): B (−25~+85°C)/X5R (−55~+85°C)】 0.3mm thickness

New part number	Old part number (for reference)	Rated voltage [V]	Temperature characteristics	Capacitance [F]	Capacitance tolerance [%]	tan δ [%]	HTLT	Thickness*3 [mm]	Note	
							Rated voltage x %			
MLASU1L3YB5104□FNA01	UMK105 BJ104□P-F	50	X5R	0.1 μ	±10, ±20	10	150	0.3±0.03		
MLAST1L3YB5103□FNA01	TMK105 BJ103□P-F	25	B	X5R	0.01 μ	±10, ±20	5	150	0.3±0.03	
MLAST1L3YB5104□FNA01	TMK105 BJ104□P-F	25	X5R	0.1 μ	±10, ±20	10	150	0.3±0.03		
MLAST1L3YB5224□FNA01	TMK105 BJ224□P-F	25	X5R	0.22 μ	±10, ±20	10	150	0.3±0.03		
MLAST1L3YB5474□FNA01	TMK105 BJ474□P-F	25	X5R	0.47 μ	±10, ±20	10	150	0.3±0.03		
MLASE1L3YB5474□FNA01	EMK105 BJ474□P-F	16	X5R	0.47 μ	±10, ±20	10	150	0.3±0.03		
MLASL1L3YB5105□FNB33	LKM105 BJ105□PLF	10	X5R	1 μ	±10, ±20	10	150	0.3±0.03		
MLASJ1L3YB5105□FNA01	JMK105 BJ105□P-F	6.3	X5R	1 μ	±10, ±20	10	150	0.3±0.03		
MLASA1L3YB5225MFA01	AMK105 BJ225MP-F	4	X5R	2.2 μ	±20	10	150	0.3±0.03		

## 【Temperature Characteristic B5(BJ): X5R (−55~+85°C)】 0.2mm thickness

New part number	Old part number (for reference)	Rated voltage [V]	Temperature characteristics	Capacitance [F]	Capacitance tolerance [%]	tan δ [%]	HTLT	Thickness*3 [mm]	Note
							Rated voltage x %		
MLASL1L2XB5104□FNA01	LKM105 BJ104□C-F	10	X5R	0.1 μ	±10, ±20	10	150	0.2±0.02	
MLASJ1L2XB5224□FNA01	JMK105 BJ224□C-F	6.3	X5R	0.22 μ	±10, ±20	10	150	0.2±0.02	
MLASJ1L2XB5474□FNA01	JMK105 BJ474□C-F	6.3	X5R	0.47 μ	±10, ±20	10	150	0.2±0.02	
MLASJ1L2XB5105MFA01	JMK105 BJ105MC-F	6.3	X5R	1 μ	±20	10	150	0.2±0.02	



## PARTS NUMBER

## 【Temperature Characteristic B5(BJ): X5R(-55~+85°C)】 0.1mm thickness

New part number	Old part number (for reference)	Rated voltage [V]	Temperature characteristics	Capacitance [F]	Capacitance tolerance [%]	tan δ [%]	HTLT	Thickness*3 [mm]	Note
							Rated voltage x %		
MLASL1LEXB5104[RNA01	LMK105 BJ104[E-R	10	X5R	0.1 μ	±10, ±20	10	150	0.18±0.02	
MLASJ1LEXB5224[RNA01	JMK105 BJ224[E-R	6.3	X5R	0.22 μ	±10, ±20	10	150	0.18±0.02	
MLASJ1LEXB5474[RNA01	JMK105 BJ474[E-R	6.3	X5R	0.47 μ	±10, ±20	10	150	0.18±0.02	
MLASA1LEXB5105MRNA01	AMK105 BJ105ME-R	4	X5R	1 μ	±20	10	150	0.18±0.02	

## 【Temperature Characteristic B5(BJ): X5R(-55~+85°C)】 0.13mm thickness

New part number	Old part number (for reference)	Rated voltage [V]	Temperature characteristics	Capacitance [F]	Capacitance tolerance [%]	tan δ [%]	HTLT	Thickness*3 [mm]	Note
							Rated voltage x %		
MLASL1LHXB5104MRNA01	LMK105 BJ104MH-R	10	X5R	0.1 μ	±20	10	150	0.13±0.02	
MLASJ1LHXB5224MRNA01	JMK105 BJ224MH-R	6.3	X5R	0.22 μ	±20	10	150	0.13±0.02	
MLASA1LHXB5474MRNA01	AMK105 BJ474MH-R	4	X5R	0.47 μ	±20	10	150	0.13±0.02	

## 【Temperature Characteristic C6 : X6S(-55~+105°C)】 0.5mm thickness

New part number	Old part number (for reference)	Rated voltage [V]	Temperature characteristics	Capacitance [F]	Capacitance tolerance [%]	tan δ [%]	HTLT	Thickness*3 [mm]	Note
							Rated voltage x %		
MLASG105CC6105[FNA01	GMK105CC6105[V-F	35	X6S	1 μ	±10, ±20	10	150	0.5+0.20/-0	
MLAST105AC6105[FNA01	TMK105AC6105[V-F	25	X6S	1 μ	±10, ±20	10	150	0.5±0.10	
MLAST105CC6105MFNA01	TMK105CC6105MV-F	25	X6S	1 μ	±20	10	150	0.5+0.20/-0	
MLASE105SC6105[FNA01	EMK105 C6105[V-F	16	X6S	1 μ	±10, ±20	10	150	0.5±0.05	
MLASE105CC6225[FNA01	EMK105CC6225[V-F	16	X6S	2.2 μ	±10, ±20	10	150	0.5+0.20/-0	
MLASL105SC6105[FNA01	LMK105 C6105[V-F	10	X6S	1 μ	±10, ±20	10	200	0.5±0.05	
MLASL105AC6225[FNA01	LMK105AC6225[V-F	10	X6S	2.2 μ	±10, ±20	10	150	0.5±0.10	
MLASJ105SC6225[FNA01	JMK105 C6225[V-F	6.3	X6S	2.2 μ	±10, ±20	10	150	0.5±0.05	
MLASJ105BC6475MFNA01	JMK105BC6475MV-F	6.3	X6S	4.7 μ	±20	10	150	0.5+0.15/-0.05	
MLASA105BC6475MFNA01	AMK105BC6475MV-F	4	X6S	4.7 μ	±20	10	200	0.5+0.15/-0.05	

## 【Temperature Characteristic B7 : X7R(-55~+125°C)】 0.5mm thickness

New part number	Old part number (for reference)	Rated voltage [V]	Temperature characteristics	Capacitance [F]	Capacitance tolerance [%]	tan δ [%]	HTLT	Thickness*3 [mm]	Note
							Rated voltage x %		
MLASU105SB7152[FNA01	UMK105 B7152[V-F	50	X7R	1500 p	±10, ±20	2.5	200	0.5±0.05	
MLASU105SB7222[FNA01	UMK105 B7222[V-F	50	X7R	2200 p	±10, ±20	2.5	200	0.5±0.05	
MLASU105SB7332[FNA01	UMK105 B7332[V-F	50	X7R	3300 p	±10, ±20	2.5	200	0.5±0.05	
MLASU105SB7472[FNA01	UMK105 B7472[V-F	50	X7R	4700 p	±10, ±20	2.5	150	0.5±0.05	
MLASU105SB7682[FNA01	UMK105 B7682[V-F	50	X7R	6800 p	±10, ±20	2.5	150	0.5±0.05	
MLASU105SB7103[FNA01	UMK105 B7103[V-F	50	X7R	0.01 μ	±10, ±20	3.5	150	0.5±0.05	
MLASU105SB7223[FNB25	UMK105 B7223[V-FR	50	X7R	0.022 μ	±10, ±20	10	200	0.5±0.05	
MLASU105SB7473[FNB25	UMK105 B7473[V-FR	50	X7R	0.047 μ	±10, ±20	10	200	0.5±0.05	
MLASU105SB7104[FNB25	UMK105 B7104[V-FR	50	X7R	0.1 μ	±10, ±20	10	150	0.5±0.05	
MLAST105SB7223[FNA01	TMK105 B7223[V-F	25	X7R	0.022 μ	±10, ±20	3.5	150	0.5±0.05	
MLAST105SB7473[FNA01	TMK105 B7473[V-F	25	X7R	0.047 μ	±10, ±20	3.5	150	0.5±0.05	
MLAST105SB7104[FNB25	TMK105 B7104[V-FR	25	X7R	0.1 μ	±10, ±20	10	200	0.5±0.05	
MLAST105SB7224[FNB25	TMK105 B7224[V-FR	25	X7R	0.22 μ	±10, ±20	10	150	0.5±0.05	
MLASE105SB7223[FNA01	EMK105 B7223[V-F	16	X7R	0.022 μ	±10, ±20	3.5	200	0.5±0.05	
MLASE105SB7473[FNA01	EMK105 B7473[V-F	16	X7R	0.047 μ	±10, ±20	3.5	200	0.5±0.05	
MLASE105SB7104[FNA01	EMK105 B7104[V-F	16	X7R	0.1 μ	±10, ±20	5	150	0.5±0.05	
MLASE105SB7224[FNB25	EMK105 B7224[V-FR	16	X7R	0.22 μ	±10, ±20	10	150	0.5±0.05	
MLASL105SB7224[FNB25	LMK105 B7224[V-FR	10	X7R	0.22 μ	±10, ±20	10	150	0.5±0.05	
MLASL105SB7474[FNA01	LMK105 B7474[V-F	10	X7R	0.47 μ	±10, ±20	10	150	0.5±0.05	
MLASJ105SB7224[FNA01	JMK105 B7224[V-F	6.3	X7R	0.22 μ	±10, ±20	5	150	0.5±0.05	
MLASJ105SB7474[FNA01	JMK105 B7474[V-F	6.3	X7R	0.47 μ	±10, ±20	10	150	0.5±0.05	

## ● 1608TYPE

## 【Temperature Characteristic B5(BJ): X5R(-55~+85°C)】 0.8mm thickness

New part number	Old part number (for reference)	Rated voltage [V]	Temperature characteristics	Capacitance [F]	Capacitance tolerance [%]	tan δ [%]	HTLT	Thickness*3 [mm]	Note
							Rated voltage x %		
MLASU168AB5474[TNA01	UMK107ABJ474[A-T	50	X5R	0.47 μ	±10, ±20	10	150	0.8+0.15/-0.05	
MLASU168BB5105[TNA01	UMK107 BJ105[A-T	50	X5R	1 μ	±10, ±20	10	150	0.8±0.10	
MLASU168BB5225[TNA01	UMK107BBJ225[A-T	50	X5R	2.2 μ	±10, ±20	10	150	0.8+0.20/-0	
MLASG168BB5475[TNA01	GMK107ABJ475[A-T	35	X5R	4.7 μ	±10, ±20	10	150	0.8+0.20/-0	
MLAST168AB5225[TNA01	TMK107ABJ225[A-T	25	X5R	2.2 μ	±10, ±20	10	150	0.8+0.15/-0.05	
MLAST168BB5475[TNA01	TMK107BBJ475[A-T	25	X5R	4.7 μ	±10, ±20	10	150	0.8+0.20/-0	
MLAST168BB5106MTNA01	TMK107BBJ106MA-T	25	X5R	10 μ	±20	10	150	0.8+0.20/-0	
MLASE168AB5475[TNA01	EMK107ABJ475[A-T	16	X5R	4.7 μ	±10, ±20	10	150	0.8+0.15/-0.05	
MLASE168BB5106MTNA01	EMK107BBJ106MA-T	16	X5R	10 μ	±20	10	150	0.8+0.20/-0	
MLASL168BB5106[TNB33	LMK107BBJ106[ALT	10	X5R	10 μ	±10, ±20	10	150	0.8+0.20/-0	
MLASL168BB5226MTNA01	LMK107BBJ226MA-T	10	X5R	22 μ	±20	10	150	0.8+0.20/-0	
MLASJ168AB5106[TNA01	JMK107ABJ106[A-T	6.3	X5R	10 μ	±10, ±20	10	150	0.8+0.15/-0.05	
MLASJ168BB5226MTNA01	JMK107BBJ226MA-T	6.3	X5R	22 μ	±20	10	150	0.8+0.20/-0	
MLASA168BB5476MRCA01	AMK107BBJ476MA-RE	4	X5R	47 μ	±20	20	150	0.8+0.20/-0	

## PARTS NUMBER

## 【Temperature Characteristic B5(BJ): X5R(-55~+85°C)】 0.45mm thickness

New part number	Old part number (for reference)	Rated voltage [V]	Temperature characteristics	Capacitance [F]	Capacitance tolerance [%]	tan δ [%]	HTLT	Thickness*3 [mm]	Note
							Rated voltage x %		
MLAST16KTB5105□TNA01	TMK107 BJ105□K-T	25	X5R	1 μ	±10, ±20	10	150	0.45±0.05	
MLASE16KTB5105□TNA01	EMK107 BJ105□K-T	16	X5R	1 μ	±10, ±20	10	150	0.45±0.05	
MLASE16KJB5225□TNA01	EMK107BJ225□K-T	16	X5R	2.2 μ	±10, ±20	10	150	0.45±0.05	
MLASL16KTB5105□TNA01	LMK107 BJ105□K-T	10	X5R	1 μ	±10, ±20	10	150	0.45±0.05	
MLASL16KTB5225□TNA01	LMK107 BJ225□K-T	10	X5R	2.2 μ	±10, ±20	10	150	0.45±0.05	
MLASL16KJB5475MTNB33	LMK107BJ475MKLT	10	X5R	4.7 μ	±20	10	150	0.45±0.05	
MLASJ16KTB5105□TNA01	JMK107 BJ105□K-T	6.3	X5R	1 μ	±10, ±20	10	150	0.45±0.05	
MLASJ16KTB5225□TNA01	JMK107 BJ225□K-T	6.3	X5R	2.2 μ	±10, ±20	10	150	0.45±0.05	
MLASJ16KTB5475MTNA01	JMK107 BJ475MK-T	6.3	X5R	4.7 μ	±20	10	150	0.45±0.05	

## 【Temperature Characteristic C6 : X6S(-55~+105°C)】 0.8mm thickness

New part number	Old part number (for reference)	Rated voltage [V]	Temperature characteristics	Capacitance [F]	Capacitance tolerance [%]	tan δ [%]	HTLT	Thickness*3 [mm]	Note
							Rated voltage x %		
MLAST168BC6225□TNA01	TMK107BC6225□A-T	25	X6S	2.2 μ	±10, ±20	10	150	0.8+0.20/-0	
MLASE168SC6105□TNA01	EMK107 C6105□A-T	16	X6S	1 μ	±10, ±20	5	150	0.8±0.10	
MLASE168BC6225□TNA01	EMK107BC6225□A-T	16	X6S	2.2 μ	±10, ±20	10	150	0.8+0.20/-0	
MLASE168BC6475□TNA01	EMK107BC6475□A-T	16	X6S	4.7 μ	±10, ±20	10	150	0.8+0.20/-0	
MLASE168BC6106MTNA01	EMK107BC6106MA-T	16	X6S	10 μ	±20	10	150	0.8+0.20/-0	
MLASL168SC6105□TNA01	LMK107 C6105□A-T	10	X6S	1 μ	±10, ±20	5	150	0.8±0.10	
MLASL168AC6475□TNA01	LMK107AC6475□A-T	10	X6S	4.7 μ	±10, ±20	10	150	0.8+0.15/-0.05	
MLASL168BC6106MTNA01	LMK107BC6106MA-T	10	X6S	10 μ	±20	10	150	0.8+0.20/-0	
MLASJ168SC6475□TNA01	JMK107 C6475□A-T	6.3	X6S	4.7 μ	±10, ±20	10	150	0.8±0.10	
MLASJ168BC6106MTNA01	JMK107BC6106MA-T	6.3	X6S	10 μ	±20	10	150	0.8+0.20/-0	
MLASA168BC6226MTNA01	AMK107BC6226MA-T	4	X6S	22 μ	±20	10	150	0.8+0.20/-0	
MLASA168BC6476MRCA01	AMK107BC6476MA-RE	4	X6S	47 μ	±20	20	150	0.8+0.20/-0	

## 【Temperature Characteristic B7 : X7R(-55~+125°C)】 0.8mm thickness

New part number	Old part number (for reference)	Rated voltage [V]	Temperature characteristics	Capacitance [F]	Capacitance tolerance [%]	tan δ [%]	HTLT	Thickness*3 [mm]	Note
							Rated voltage x %		
MLASU168SB7224□TNB25	UMK107 B7224□A-TR	50	X7R	0.22 μ	±10, ±20	10	150	0.8±0.10	
MLASU168SB7474□TNB25	UMK107 B7474□A-TR	50	X7R	0.47 μ	±10, ±20	10	150	0.8±0.10	
MLASU168AB7105□TNA01	UMK107AB7105□A-T	50	X7R	1 μ	±10, ±20	10	150	0.8+0.15/-0.05	
MLAST168SB7474□TNB25	TMK107 B7474□A-TR	25	X7R	0.47 μ	±10, ±20	10	150	0.8±0.10	
MLAST168SB7105□TNA01	TMK107 B7105□A-T	25	X7R	1 μ	±10, ±20	10	150	0.8±0.10	
MLASE168SB7474□TNA01	EMK107 B7474□A-T	16	X7R	0.47 μ	±10, ±20	3.5	150	0.8±0.10	
MLASE168SB7105□TNA01	EMK107 B7105□A-T	16	X7R	1 μ	±10, ±20	5	150	0.8±0.10	
MLASE168BB7225□TNA01	EMK107BB7225□A-T	16	X7R	2.2 μ	±10, ±20	10	150	0.8+0.20/-0	
MLASL168SB7225□TNB25	LMK107 B7225□A-TR	10	X7R	2.2 μ	±10, ±20	10	150	0.8±0.10	
MLASJ168SB7225□TNB25	JMK107 B7225□A-TR	6.3	X7R	2.2 μ	±10, ±20	10	200	0.8±0.10	
MLASJ168BB7475□TNA01	JMK107BB7475□A-T	6.3	X7R	4.7 μ	±10, ±20	10	150	0.8+0.20/-0	

## 2012TYPE

## 【Temperature Characteristic B5(BJ): X5R(-55~+85°C)】 1.25mm thickness

New part number	Old part number (for reference)	Rated voltage [V]	Temperature characteristics	Capacitance [F]	Capacitance tolerance [%]	tan δ [%]	HTLT	Thickness*3 [mm]	Note
							Rated voltage x %		
MLASU21GBB5475□TNA01	UMK212BBJ475□G-T	50	X5R	4.7 μ	±10, ±20	10	150	1.25+0.20/-0	
MLASG21GBB5106□TNA01	GMK212BBJ106□G-T	35	X5R	10 μ	±10, ±20	10	150	1.25+0.20/-0	
MLAST21GAB5475□TNA01	TMK212ABJ475□G-T	25	X5R	4.7 μ	±10, ±20	10	150	1.25+0.15/-0.05	
MLAST21GBB5106□TNA01	TMK212BBJ106□G-T	25	X5R	10 μ	±10, ±20	10	150	1.25+0.20/-0	
MLAST21GBB5226MTNC12	TMK212BBJ226MG-TT	25	X5R	22 μ	±20	10	150	1.25+0.20/-0	
MLASE21GAB5106□TNA01	EMK212ABJ106□G-T	16	X5R	10 μ	±10, ±20	10	150	1.25+0.15/-0.05	
MLASE21GBB5226MTNA01	EMK212BBJ226MG-T	16	X5R	22 μ	±20	10	150	1.25+0.20/-0	
MLASL21GBB5226MTNA01	LMK212BBJ226MG-T	10	X5R	22 μ	±20	10	150	1.25+0.20/-0	
MLASL21GAB5476MTNA01	LMK212BBJ476MG-T	10	X5R	47 μ	±20	10	150	1.25+0.20/-0	
MLASJ21GAB5226□TNA01	JMK212ABJ226□G-T	6.3	X5R	22 μ	±10, ±20	10	150	1.25+0.15/-0.05	
MLASJ21GBB5476MTNA01	JMK212BBJ476MG-T	6.3	X5R	47 μ	±20	10	150	1.25+0.20/-0	
MLASA21GBB5107MTCA01	AMK212BBJ107MG-TE	4	X5R	100 μ	±20	20	150	1.25+0.20/-0	

## PARTS NUMBER

## 【Temperature Characteristic B5(BJ): B(-25~+85°C)/X5R(-55~+85°C)】0.85mm thickness

New part number	Old part number (for reference)	Rated voltage [V]	Temperature characteristics	Capacitance [F]	Capacitance tolerance [%]	tan δ [%]	HTLT	Thickness*3 [mm]	Note
							Rated voltage x %		
MLASU219JB5105□TNA01	UMK212ABJ105□D-T	50	X5R	1 μ	±10, ±20	10	150	0.85±0.10	
MLASU219LB5225□TNA01	UMK212BBJ225□D-T	50	X5R	2.2 μ	±10, ±20	10	150	0.85±0.10	
MLASG219LB5475□TNA01	GMK212BBJ475□D-T	35	X5R	4.7 μ	±10, ±20	10	150	0.85±0.10	
MLAST219SB5474□TNA01	TMK212 BJ474□D-T	25	B X5R	0.47 μ	±10, ±20	3.5	200	0.85±0.10	
MLAST219SB5105□TNA01	TMK212 BJ105□D-T	25	B X5R	1 μ	±10, ±20	5	200	0.85±0.10	
MLAST219JB5225□TNA01	TMK212ABJ225□D-T	25	X5R	2.2 μ	±10, ±20	5	150	0.85±0.10	
MLAST219LB5475□TNA01	TMK212BBJ475□D-T	25	X5R	4.7 μ	±10, ±20	10	150	0.85±0.10	
MLAST219LB5106□TNA01	TMK212BBJ106□D-T	25	X5R	10 μ	±10, ±20	10	150	0.85±0.10	
MLASE219SB5105□TNA01	EMK212 BJ105□D-T	16	X5R*1	1 μ	±10, ±20	5	200	0.85±0.10	
MLASE219JB5225□TNA01	EMK212ABJ225□D-T	16	X5R*1	2.2 μ	±10, ±20	5	200	0.85±0.10	
MLASE219SB5475□TNA01	EMK212 BJ475□D-T	16	X5R	4.7 μ	±10, ±20	10	150	0.85±0.10	
MLASE219JB5106□TNA01	EMK212ABJ106□D-T	16	X5R	10 μ	±10, ±20	10	150	0.85±0.10	
MLASL219SB5105□TNA01	LМК212 BJ105□D-T	10	B X5R*1	1 μ	±10, ±20	3.5	200	0.85±0.10	
MLASL219SB5225□TNA01	LМК212 BJ225□D-T	10	X5R*1	2.2 μ	±10, ±20	5	200	0.85±0.10	
MLASL219JB5106□TNA01	LМК212ABJ106□D-T	10	X5R	10 μ	±10, ±20	10	150	0.85±0.10	
MLASL219LB5226MTNA01	LМК212BBJ226MD-T	10	X5R	22 μ	±20	10	150	0.85±0.10	
MLASJ219JB5106□TNA01	JMK212ABJ106□D-T	6.3	X5R	10 μ	±10, ±20	10	200	0.85±0.10	
MLASJ219JB5226MTNA01	JMK212ABJ226MD-T	6.3	X5R	22 μ	±20	10	150	0.85±0.10	

## 【Temperature Characteristic C6 : X6S(-55~+105°C)】1.25mm thickness

New part number	Old part number (for reference)	Rated voltage [V]	Temperature characteristics	Capacitance [F]	Capacitance tolerance [%]	tan δ [%]	HTLT	Thickness*3 [mm]	Note
							Rated voltage x %		
MLAST21GBC6106□TNA01	TMK212BC6106□G-T	25	X6S	10 μ	±10, ±20	10	150	1.25+0.20/-0	
MLASE21GBC6226MTNC12	EMK212BC6226MG-TT	16	X6S	22 μ	±20	10	150	1.25+0.20/-0	
MLASL21GBC6226MTNA01	LМК212BC6226MG-T	10	X6S	22 μ	±20	10	150	1.25+0.20/-0	
MLASJ21GBC6226MTNA01	JMK212BC6226MG-T	6.3	X6S	22 μ	±20	10	150	1.25+0.20/-0	
MLASA21GAC6226MTNA01	AMK212AC6226MG-T	4	X6S	22 μ	±20	10	150	1.25+0.15/-0.05	
MLASA21GBC6476MTNA01	AMK212BC6476MG-T	4	X6S	47 μ	±20	10	150	1.25+0.20/-0	

## 【Temperature Characteristic C6 : X6S(-55~+105°C)】0.85mm thickness

New part number	Old part number (for reference)	Rated voltage [V]	Temperature characteristics	Capacitance [F]	Capacitance tolerance [%]	tan δ [%]	HTLT	Thickness*3 [mm]	Note
							Rated voltage x %		
MLASL219JC6106□TNA01	LМК212AC6106□D-T	10	X6S	10 μ	±10, ±20	10	150	0.85±0.10	
MLASA219LC6226MTNA01	AMK212BC6226MD-T	4	X6S	22 μ	±20	10	150	0.85±0.10	

## 【Temperature Characteristic B7 : X7R(-55~+125°C)】1.25mm thickness

New part number	Old part number (for reference)	Rated voltage [V]	Temperature characteristics	Capacitance [F]	Capacitance tolerance [%]	tan δ [%]	HTLT	Thickness*3 [mm]	Note
							Rated voltage x %		
MLASU21GSB7224□TNA01	UMK212 B7224□G-T	50	X7R	0.22 μ	±10, ±20	3.5	150	1.25±0.10	
MLASU21GSB7474□TNA01	UMK212 B7474□G-T	50	X7R	0.47 μ	±10, ±20	3.5	150	1.25±0.10	
MLASU21GSB7105□TNA01	UMK212 B7105□G-T	50	X7R	1 μ	±10, ±20	10	150	1.25±0.10	
MLASU21GGB7225□TNA01	UMK212BB7225□G-T	50	X7R	2.2 μ	±10, ±20	10	150	1.25+0.20/-0	
MLASG21GSB7105□TNA01	GMK212 B7105□G-T	35	X7R	1 μ	±10, ±20	10	150	1.25±0.10	
MLAST21GSB7225□TNB25	TMK212 B7225□G-TR	25	X7R	2.2 μ	±10, ±20	10	150	1.25±0.10	
MLAST21GAB7475□TNA01	TMK212AB7475□G-T	25	X7R	4.7 μ	±10, ±20	10	150	1.25+0.15/-0.05	
MLASE21GSB7475□TNA01	EMK212 B7475□G-T	16	X7R	4.7 μ	±10, ±20	10	150	1.25±0.10	
MLASE21GGB7106MTNA01	EMK212BB7106MG-T	16	X7R	10 μ	±20	10	150	1.25+0.20/-0	
MLASL21GAB7106□TNA01	LМК212AB7106□G-T	10	X7R	10 μ	±10, ±20	10	150	1.25+0.15/-0.05	
MLASJ21GAB7106□TNA01	JMK212AB7106□G-T	6.3	X7R	10 μ	±10, ±20	10	150	1.25+0.15/-0.05	

## 【Temperature Characteristic B7 : X7R(-55~+125°C)】0.85mm thickness

New part number	Old part number (for reference)	Rated voltage [V]	Temperature characteristics	Capacitance [F]	Capacitance tolerance [%]	tan δ [%]	HTLT	Thickness*3 [mm]	Note
							Rated voltage x %		
MLASU219JB7104□TNA01	UMK212AB7104□D-T	50	X7R	0.1 μ	±10, ±20	10	150	0.85±0.10	
MLASU219JB7224□TNA01	UMK212AB7224□D-T	50	X7R	0.22 μ	±10, ±20	10	150	0.85±0.10	
MLASU219JB7474□TNA01	UMK212AB7474□D-T	50	X7R	0.47 μ	±10, ±20	10	150	0.85±0.10	
MLASU219JB7105□TNA01	UMK212AB7105□D-T	50	X7R	1 μ	±10, ±20	10	150	0.85±0.10	
MLAST219JB7225□TNB25	TMK212AB7225□D-TR	25	X7R	2.2 μ	±10, ±20	10	150	0.85±0.10	
MLASE219SB7474□TNA01	EMK212 B7474□D-T	16	X7R	0.47 μ	±10, ±20	3.5	200	0.85±0.10	
MLASE219SB7105□TNA01	EMK212 B7105□D-T	16	X7R	1 μ	±10, ±20	5	200	0.85±0.10	
MLASE219JB7225□TNA01	EMK212AB7225□D-T	16	X7R	2.2 μ	±10, ±20	5	150	0.85±0.10	
MLASE219LB7475MTNA01	EMK212BB7475MD-T	16	X7R	4.7 μ	±20	10	150	0.85±0.10	
MLASL219SB7105□TNA01	LМК212 B7105□D-T	10	X7R	1 μ	±10, ±20	3.5	200	0.85±0.10	
MLASL219JB7225□TNA01	LМК212AB7225□D-T	10	X7R	2.2 μ	±10, ±20	5	200	0.85±0.10	
MLASL219JB7475□TNB25	LМК212AB7475□D-TR	10	X7R	4.7 μ	±10, ±20	10	150	0.85±0.10	

## PARTS NUMBER

## 3216TYPE

【Temperature Characteristic B5(BJ): X5R(-55~+85°C)】 1.6mm thickness

New part number	Old part number (for reference)	Rated voltage [V]	Temperature characteristics	Capacitance [F]	Capacitance tolerance [%]	tan δ [%]	HTLT	Thickness*3 [mm]	Note
							Rated voltage x %		
MLASU31LSB5475□TNA01	UMK316 BJ475□L-T	50	X5R	4.7 μ	±10, ±20	10	150	1.6±0.20	
MLASU31LBB5106□TNA01	UMK316BBJ106□L-T	50	X5R	10 μ	±10, ±20	10	150	1.6±0.30	
MLAST31LBB5226MTNA01	TMK316BBJ226ML-T	25	X5R	22 μ	±20	10	150	1.6±0.30	
MLASE31LBB5476MTNA01	EMK316BBJ476ML-T	16	X5R	47 μ	±20	10	150	1.6±0.30	
MLASL31LAB5476MTNA01	LMK316ABJ476ML-T	10	X5R	47 μ	±20	10	150	1.6±0.20	
MLASJ31LAB5107MTNA01	JMK316ABJ107ML-T	6.3	X5R	100 μ	±20	10	150	1.6±0.20	
MLASA31LAB5107MTNA01	AMK316ABJ107ML-T	4	X5R	100 μ	±20	10	150	1.6±0.20	
MLASA31LBB5157MTNA01	AMK316BBJ157ML-T	4	X5R	150 μ	±20	10	150	1.6±0.30	
MLASP31LBB5227MTNA01	PMK316BBJ227ML-T	2.5	X5R	220 μ	±20	10	150	1.6±0.30	

【Temperature Characteristic B5(BJ): B(-25~+85°C)/X5R(-55~+85°C)】 0.85mm thickness

New part number	Old part number (for reference)	Rated voltage [V]	Temperature characteristics	Capacitance [F]	Capacitance tolerance [%]	tan δ [%]	HTLT	Thickness*3 [mm]	Note
							Rated voltage x %		
MLASU319HB5105□TNA01	UMK316 BJ105□D-T	50	B X5R	1 μ	±10, ±20	3.5	150	0.85±0.10	
MLASU319HB5225□TNA01	UMK316 BJ225□D-T	50	B X5R	2.2 μ	±10, ±20	3.5	150	0.85±0.10	
MLASU319LB5475□TNA01	UMK316ABJ475□D-T	50	X5R	4.7 μ	±10, ±20	10	150	0.85±0.10	
MLAST319HB5105□TNA01	TMK316 BJ105□D-T	25	B X5R	1 μ	±10, ±20	3.5	200	0.85±0.10	
MLAST319HB5225□TNA01	TMK316 BJ225□D-T	25	B X5R	2.2 μ	±10, ±20	3.5	150	0.85±0.10	
MLAST319HB5475□TNA01	TMK316 BJ475□D-T	25	X5R	4.7 μ	±10, ±20	5	150	0.85±0.10	
MLAST319LB5106□TNA01	TMK316ABJ106□D-T	25	X5R	10 μ	±10, ±20	10	150	0.85±0.10	
MLASE319HB5225□TNA01	EMK316 BJ225□D-T	16	B X5R	2.2 μ	±10, ±20	3.5	200	0.85±0.10	
MLASE319HB5475□TNA01	EMK316 BJ475□D-T	16	B X5R	4.7 μ	±10, ±20	5	200	0.85±0.10	
MLASE319HB5106□TNA01	EMK316 BJ106□D-T	16	X5R	10 μ	±10, ±20	10	150	0.85±0.10	
MLASE319LB5226MTNA01	EMK316ABJ226MD-T	16	X5R	22 μ	±20	10	150	0.85±0.10	
MLASL319HB5475□TNA01	LMK316 BJ475□D-T	10	B X5R	4.7 μ	±10, ±20	5	200	0.85±0.10	
MLASL319HB5106□TNA01	LMK316 BJ106□D-T	10	X5R	10 μ	±10, ±20	10	200	0.85±0.10	
MLASL319LB5226MTNA01	LMK316ABJ226MD-T	10	X5R	22 μ	±20	10	150	0.85±0.10	
MLASJ319HB5106□TNA01	JMK316 BJ106□D-T	6.3	X5R	10 μ	±10, ±20	10	200	0.85±0.10	
MLASJ319LB5226MTNA01	JMK316ABJ226MD-T	6.3	X5R	22 μ	±20	10	150	0.85±0.10	
MLASJ319LB5476MTNA01	JMK316ABJ476MD-T	6.3	X5R	47 μ	±20	10	150	0.85±0.10	

【Temperature Characteristic C6 : X6S(-55~+105°C)】 1.6mm thickness

New part number	Old part number (for reference)	Rated voltage [V]	Temperature characteristics	Capacitance [F]	Capacitance tolerance [%]	tan δ [%]	HTLT	Thickness*3 [mm]	Note
							Rated voltage x %		
MLASE31LBC6226MTNA01	EMK316BC6226ML-T	16	X6S	22 μ	±20	10	150	1.6±0.30	
MLASL31LBC6476MTNA01	LMK316BC6476ML-T	10	X6S	47 μ	±20	10	150	1.6±0.30	
MLASJ31LAC6476MTNA01	JMK316AC6476ML-T	6.3	X6S	47 μ	±20	10	150	1.6±0.20	
MLASA31LAC6476MTNA01	AMK316AC6476ML-T	4	X6S	47 μ	±20	10	200	1.6±0.20	
MLASA31LAC6107MTNA01	AMK316AC6107ML-T	4	X6S	100 μ	±20	10	150	1.6±0.20	

【Temperature Characteristic C7 : X7S(-55~+125°C)】 1.6mm thickness

New part number	Old part number (for reference)	Rated voltage [V]	Temperature characteristics	Capacitance [F]	Capacitance tolerance [%]	tan δ [%]	HTLT	Thickness*3 [mm]	Note
							Rated voltage x %		
MLASJ31LAC7476MTNA01	JMK316AC7476ML-T	6.3	X7S	47 μ	±20	10	150	1.6±0.20	
MLASA31LAC7476MTNA01	AMK316AC7476ML-T	4	X7S	47 μ	±20	10	150	1.6±0.20	

【Temperature Characteristic B7 : X7R(-55~+125°C)】 1.6mm thickness

New part number	Old part number (for reference)	Rated voltage [V]	Temperature characteristics	Capacitance [F]	Capacitance tolerance [%]	tan δ [%]	HTLT	Thickness*3 [mm]	Note
							Rated voltage x %		
MLASU31LSB7225□TNA01	UMK316 B7225□L-T	50	X7R	2.2 μ	±10, ±20	10	150	1.6±0.20	
MLASU31LAB7475□TNA01	UMK316AB7475□L-T	50	X7R	4.7 μ	±10, ±20	10	150	1.6±0.20	
MLASG31LAB7106□TNA01	GMK316AB7106□L-TR	35	X7R	10 μ	±10, ±20	10	150	1.6±0.20	
MLAST31LAB7475□TNA01	TMK316AB7475□L-T	25	X7R	4.7 μ	±10, ±20	10	200	1.6±0.20	
MLAST31LAB7106□TNA01	TMK316AB7106□L-T	25	X7R	10 μ	±10, ±20	10	150	1.6±0.20	
MLASE31LSB7475□TNA01	EMK316 B7475□L-T	16	X7R	4.7 μ	±10, ±20	5	200	1.6±0.20	
MLASE31LAB7106□TNA01	EMK316AB7106□L-T	16	X7R	10 μ	±10, ±20	10	200	1.6±0.20	
MLASL31LAB7106□TNA01	LMK316AB7106□L-T	10	X7R	10 μ	±10, ±20	10	200	1.6±0.20	
MLASL31LAB7226□TNA01	LMK316AB7226□L-TR	10	X7R	22 μ	±10, ±20	10	150	1.6±0.20	

【Temperature Characteristic B7 : X7R(-55~+125°C)】 0.85mm thickness

New part number	Old part number (for reference)	Rated voltage [V]	Temperature characteristics	Capacitance [F]	Capacitance tolerance [%]	tan δ [%]	HTLT	Thickness*3 [mm]	Note
							Rated voltage x %		
MLASU319HB7225□TNA01	UMK316 B7225□D-T	50	X7R	2.2 μ	±10, ±20	10	150	0.85±0.10	
MLAST319LB7475□TNA01	TMK316AB7475□D-T	25	X7R	4.7 μ	±10, ±20	10	150	0.85±0.10	
MLASL319LB7106MTNA01	LMK316AB7106MD-T	10	X7R	10 μ	±20	10	150	0.85±0.10	

## PARTS NUMBER

## 3225TYPE

【Temperature Characteristic B5(BJ): X5R(-55~+85°C)】 2.5mm thickness

New part number	Old part number (for reference)	Rated voltage [V]	Temperature characteristics	Capacitance [F]	Capacitance tolerance [%]	tan δ [%]	HTLT	Thickness*3 [mm]	Note
							Rated voltage x %		
MLASU32MSB5106[PNA01	UMK325 BJ106[M-P	50	X5R	10 μ	±10, ±20	5	150	2.5±0.20	
MLASG32MSB5226MPNA01	GMK325 BJ226MM-P	35	X5R	22 μ	±20	5	150	2.5±0.20	
MLAST32MAB5476MPNDT1	TMK325ABJ476MM-P	25	X5R	47 μ	±20	10	150	2.5±0.30	
MLASE32MAB5107MPNA01	EMK325ABJ107MM-P	16	X5R	100 μ	±20	10	150	2.5±0.30	
MLASL32MAB5107MPNA01	LMK325ABJ107MM-P	10	X5R	100 μ	±20	10	150	2.5±0.30	
MLASJ32MAB5157MPNDT1	JMK325ABJ157MM-P	6.3	X5R	150 μ	±20	10	150	2.5±0.30	
MLASJ32MAB5227MPNDT1	JMK325ABJ227MM-P	6.3	X5R	220 μ	±20	10	150	2.5±0.30	
MLASA32MAB5157MPNDT1	AMK325ABJ157MM-P	4	X5R	150 μ	±20	10	150	2.5±0.30	
MLASA32MAB5227MPNDT1	AMK325ABJ227MM-P	4	X5R	220 μ	±20	10	150	2.5±0.30	

【Temperature Characteristic B5(BJ): B(-25~+85°C)/X5R(-55~+85°C)】 1.9mm thickness

New part number	Old part number (for reference)	Rated voltage [V]	Temperature characteristics	Capacitance [F]	Capacitance tolerance [%]	tan δ [%]	HTLT	Thickness*3 [mm]	Note
							Rated voltage x %		
MLASU32NSB5475[TNA01	UMK325 BJ475[N-T	50	X5R	4.7 μ	±10, ±20	10	150	1.9±0.20	
MLASG32NSB5225[TNA01	GMK325 BJ225[N-T	35	B X5R	2.2 μ	±10, ±20	3.5	200	1.9±0.20	
MLASG32NSB5475[TNA01	GMK325 BJ475[N-T	35	X5R	4.7 μ	±10, ±20	10	150	1.9±0.20	
MLASG32NSB5106[TNA01	GMK325 BJ106[N-T	35	X5R	10 μ	±10, ±20	5	150	1.9±0.20	
MLAST32NSB5335MTNA01	TMK325 BJ335MN-T	25	B X5R <sup>*1</sup>	3.3 μ	±20	3.5	200	1.9±0.20	
MLAST32NSB5475[TNA01	TMK325 BJ475[N-T	25	B X5R <sup>*1</sup>	4.7 μ	±10, ±20	3.5	200	1.9±0.20	
MLAST32NSB5106[TNA01	TMK325 BJ106[N-T	25	X5R	10 μ	±10, ±20	5	200	1.9±0.20	
MLASE32NSB5475[TNA01	EMK325 BJ475[N-T	16	B X5R <sup>*1</sup>	4.7 μ	±10, ±20	3.5	200	1.9±0.20	
MLASE32NSB5106[TNA01	EMK325 BJ106[N-T	16	X5R	10 μ	±10, ±20	3.5	200	1.9±0.20	
MLASE32YBB5476MTNA01	EMK325 BJ476MY-T	16	X5R	47 μ	±20	10	150	1.9+0.1/-0.2	
MLASL32NSB5106[TNA01	LMK325 BJ106[N-T	10	X5R	10 μ	±10, ±20	3.5	200	1.9±0.20	
MLASL32YBB5226MTNA01	LMK325 BJ226MY-T	10	B X5R	22 μ	±20	5	150	1.9+0.1/-0.2	
MLASJ32YBB5226MTNA01	JMK325 BJ226MY-T	6.3	B X5R	22 μ	±20	5	200	1.9+0.1/-0.2	

【Temperature Characteristic B5(BJ): B(-25~+85°C)/X5R(-55~+85°C)】 0.85mm thickness

New part number	Old part number (for reference)	Rated voltage [V]	Temperature characteristics	Capacitance [F]	Capacitance tolerance [%]	tan δ [%]	HTLT	Thickness*3 [mm]	Note
							Rated voltage x %		
MLAST329JB5106[TNA01	TMK325 BJ106[D-T	25	X5R	10 μ	±10, ±20	5	150	0.85±0.10	
MLASE329JB5106[TNA01	EMK325 BJ106[D-T	16	X5R	10 μ	±10, ±20	5	150	0.85±0.10	
MLASE329JB5226MTNA01	EMK325 BJ226MD-T	16	X5R	22 μ	±20	10	150	0.85±0.10	
MLASL329JB5335[TNA01	LMK325 BJ335[D-T	10	B X5R	3.3 μ	±10, ±20	3.5	200	0.85±0.10	
MLASL329JB5475[TNA01	LMK325 BJ475[D-T	10	B X5R	4.7 μ	±10, ±20	5	200	0.85±0.10	
MLASL329JB5106[TNA01	LMK325 BJ106[D-T	10	X5R	10 μ	±10, ±20	5	150	0.85±0.10	

【Temperature Characteristic C6 : X6S(-55~+105°C)】 2.5mm thickness

New part number	Old part number (for reference)	Rated voltage [V]	Temperature characteristics	Capacitance [F]	Capacitance tolerance [%]	tan δ [%]	HTLT	Thickness*3 [mm]	Note
							Rated voltage x %		
MLASE32MAC6476MPNDT1	EMK325AC6476MM-P	16	X6S	47 μ	±20	10	150	2.5±0.30	
MLASL32MAC6107MPNA01	LMK325AC6107MM-P	10	X6S	100 μ	±20	10	150	2.5±0.30	
MLASA32MAC6157MPNDT1	AMK325AC6157MM-P	4	X6S	150 μ	±20	10	150	2.5±0.30	
MLASA32MAC6227MPNDT1	AMK325AC6227MM-P	4	X6S	220 μ	±20	10	150	2.5±0.30	
MLASP32MAC6227MPNDT1	PMK325AC6227MM-P	2.5	X6S	220 μ	±20	10	200	2.5±0.30	

【Temperature Characteristic B7 : X7R(-55~+125°C)】 2.5mm thickness

New part number	Old part number (for reference)	Rated voltage [V]	Temperature characteristics	Capacitance [F]	Capacitance tolerance [%]	tan δ [%]	HTLT	Thickness*3 [mm]	Note
							Rated voltage x %		
MLASU32MSB7335[PNA01	UMK325 B7335[M-P	50	X7R	3.3 μ	±10, ±20	3.5	200	2.5±0.20	
MLASU32MSB7475[PNA01	UMK325 B7475[M-P	50	X7R	4.7 μ	±10, ±20	5	150	2.5±0.20	
MLASU32MAB7106[PNA01	UMK325AB7106[M-P	50	X7R	10 μ	±10, ±20	10	150	2.5±0.30	
MLAST32MAB7106[PNA01	TMK325AB7106[M-P	25	X7R	10 μ	±10, ±20	10	200	2.5±0.30	
MLAST32MSB7226[PNB25	TMK325 B7226[M-PR	25	X7R	22 μ	±10, ±20	10	150	2.5±0.20	
MLASE32MSB7226[PNB25	EMK325 B7226[M-PR	16	X7R	22 μ	±10, ±20	10	150	2.5±0.20	
MLASL32MSB7476[PNB25	LMK325 B7476[M-PR	10	X7R	47 μ	±10, ±20	10	150	2.5±0.20	
MLASJ32MSB7476[PNB25	JMK325 B7476[M-PR	6.3	X7R	47 μ	±10, ±20	10	200	2.5±0.20	

【Temperature Characteristic B7 : X7R(-55~+125°C)】 1.9mm thickness

New part number	Old part number (for reference)	Rated voltage [V]	Temperature characteristics	Capacitance [F]	Capacitance tolerance [%]	tan δ [%]	HTLT	Thickness*3 [mm]	Note
							Rated voltage x %		
MLASU32NSB7475[TNB25	UMK325 B7475[N-TR	50	X7R	4.7 μ	±10, ±20	10	150	1.9±0.20	
MLAST32NSB7335[TNA01	TMK325 B7335[N-T	25	X7R	3.3 μ	±10, ±20	3.5	200	1.9±0.20	
MLAST32NSB7475[TNA01	TMK325 B7475[N-T	25	X7R	4.7 μ	±10, ±20	3.5	150	1.9±0.20	
MLAST32NSB7106[TNB25	TMK325 B7106[N-TR	25	X7R	10 μ	±10, ±20	10	150	1.9±0.20	
MLASE32NSB7475[TNA01	EMK325 B7475[N-T	16	X7R	4.7 μ	±10, ±20	3.5	200	1.9±0.20	
MLASE32NSB7106[TNA01	EMK325 B7106[N-T	16	X7R	10 μ	±10, ±20	3.5	150	1.9±0.20	
MLASL32NSB7106[TNA01	LMK325 B7106[N-T	10	X7R	10 μ	±10, ±20	3.5	200	1.9±0.20	



PARTS NUMBER

Multilayer Ceramic Capacitors (Temperature compensating type) for Medical Devices classified as GHTF Classes A or B (Japan Classes I or II)

0402TYPE

【Temperature Characteristic  $C\Delta$  :  $C\Delta/C0\Delta$  (-55~+125°C)】 0.2mm thickness

New part number	Old part number (for reference)	Rated voltage [V]	Temperature characteristics	Capacitance [F]	Capacitance tolerance	Q (at 1MHz) (min)	HTLT	Thickness*3 [mm]	Note
							Rated voltage x %		
MLAST042SCK0R4[WNA01]	TMK042 CK0R4[D-W]	25	CK C0K	0.4 p	±0.05pF, ±0.1pF, ±0.25pF	408	200	0.2±0.02	
MLAST042SCK0R5[WNA01]	TMK042 CK0R5[D-W]	25	CK C0K	0.5 p	±0.05pF, ±0.1pF, ±0.25pF	410	200	0.2±0.02	
MLAST042SCK0R6[WNA01]	TMK042 CK0R6[D-W]	25	CK C0K	0.6 p	±0.05pF, ±0.1pF, ±0.25pF	412	200	0.2±0.02	
MLAST042SCK0R7[WNA01]	TMK042 CK0R7[D-W]	25	CK C0K	0.7 p	±0.05pF, ±0.1pF, ±0.25pF	414	200	0.2±0.02	
MLAST042SCKR75[WNA01]	TMK042 CKR75[D-W]	25	CK C0K	0.75 p	±0.05pF, ±0.1pF, ±0.25pF	415	200	0.2±0.02	
MLAST042SCK0R8[WNA01]	TMK042 CK0R8[D-W]	25	CK C0K	0.8 p	±0.05pF, ±0.1pF, ±0.25pF	416	200	0.2±0.02	
MLAST042SCK0R9[WNA01]	TMK042 CK0R9[D-W]	25	CK C0K	0.9 p	±0.05pF, ±0.1pF, ±0.25pF	418	200	0.2±0.02	
MLAST042SCK010[WNA01]	TMK042 CK010[D-W]	25	CK C0K	1 p	±0.05pF, ±0.1pF, ±0.25pF	420	200	0.2±0.02	
MLAST042SCK1R1[WNA01]	TMK042 CK1R1[D-W]	25	CK C0K	1.1 p	±0.05pF, ±0.1pF, ±0.25pF	422	200	0.2±0.02	
MLAST042SCK1R2[WNA01]	TMK042 CK1R2[D-W]	25	CK C0K	1.2 p	±0.05pF, ±0.1pF, ±0.25pF	424	200	0.2±0.02	
MLAST042SCK1R3[WNA01]	TMK042 CK1R3[D-W]	25	CK C0K	1.3 p	±0.05pF, ±0.1pF, ±0.25pF	426	200	0.2±0.02	
MLAST042SCK1R4[WNA01]	TMK042 CK1R4[D-W]	25	CK C0K	1.4 p	±0.05pF, ±0.1pF, ±0.25pF	428	200	0.2±0.02	
MLAST042SCK1R5[WNA01]	TMK042 CK1R5[D-W]	25	CK C0K	1.5 p	±0.05pF, ±0.1pF, ±0.25pF	430	200	0.2±0.02	
MLAST042SCK1R6[WNA01]	TMK042 CK1R6[D-W]	25	CK C0K	1.6 p	±0.05pF, ±0.1pF, ±0.25pF	432	200	0.2±0.02	
MLAST042SCK1R7[WNA01]	TMK042 CK1R7[D-W]	25	CK C0K	1.7 p	±0.05pF, ±0.1pF, ±0.25pF	434	200	0.2±0.02	
MLAST042SCK1R8[WNA01]	TMK042 CK1R8[D-W]	25	CK C0K	1.8 p	±0.05pF, ±0.1pF, ±0.25pF	436	200	0.2±0.02	
MLAST042SCK1R9[WNA01]	TMK042 CK1R9[D-W]	25	CK C0K	1.9 p	±0.05pF, ±0.1pF, ±0.25pF	438	200	0.2±0.02	
MLAST042SCK020[WNA01]	TMK042 CK020[D-W]	25	CK C0K	2 p	±0.05pF, ±0.1pF, ±0.25pF	440	200	0.2±0.02	
MLAST042SCK2R1[WNA01]	TMK042 CK2R1[D-W]	25	CK C0K	2.1 p	±0.05pF, ±0.1pF, ±0.25pF	442	200	0.2±0.02	
MLAST042SCK2R2[WNA01]	TMK042 CK2R2[D-W]	25	CK C0K	2.2 p	±0.05pF, ±0.1pF, ±0.25pF	444	200	0.2±0.02	
MLAST042SCK2R3[WNA01]	TMK042 CK2R3[D-W]	25	CK C0K	2.3 p	±0.05pF, ±0.1pF, ±0.25pF	446	200	0.2±0.02	
MLAST042SCK2R4[WNA01]	TMK042 CK2R4[D-W]	25	CK C0K	2.4 p	±0.05pF, ±0.1pF, ±0.25pF	448	200	0.2±0.02	
MLAST042SCK2R5[WNA01]	TMK042 CK2R5[D-W]	25	CK C0K	2.5 p	±0.05pF, ±0.1pF, ±0.25pF	450	200	0.2±0.02	
MLAST042SCK2R6[WNA01]	TMK042 CK2R6[D-W]	25	CK C0K	2.6 p	±0.05pF, ±0.1pF, ±0.25pF	452	200	0.2±0.02	
MLAST042SCK2R7[WNA01]	TMK042 CK2R7[D-W]	25	CK C0K	2.7 p	±0.05pF, ±0.1pF, ±0.25pF	454	200	0.2±0.02	
MLAST042SCK2R8[WNA01]	TMK042 CK2R8[D-W]	25	CK C0K	2.8 p	±0.05pF, ±0.1pF, ±0.25pF	456	200	0.2±0.02	
MLAST042SCK2R9[WNA01]	TMK042 CK2R9[D-W]	25	CK C0K	2.9 p	±0.05pF, ±0.1pF, ±0.25pF	458	200	0.2±0.02	
MLAST042SCK030[WNA01]	TMK042 CJK030[D-W]	25	CK C0J	3 p	±0.05pF, ±0.1pF, ±0.25pF	460	200	0.2±0.02	
MLAST042SCK3R1[WNA01]	TMK042 CJK3R1[D-W]	25	CJ C0J	3.1 p	±0.1pF, ±0.25pF	462	200	0.2±0.02	
MLAST042SCK3R2[WNA01]	TMK042 CJK3R2[D-W]	25	CJ C0J	3.2 p	±0.1pF, ±0.25pF	464	200	0.2±0.02	
MLAST042SCK3R3[WNA01]	TMK042 CJK3R3[D-W]	25	CJ C0J	3.3 p	±0.1pF, ±0.25pF	466	200	0.2±0.02	
MLAST042SCK3R4[WNA01]	TMK042 CJK3R4[D-W]	25	CJ C0J	3.4 p	±0.1pF, ±0.25pF	468	200	0.2±0.02	
MLAST042SCK3R5[WNA01]	TMK042 CJK3R5[D-W]	25	CJ C0J	3.5 p	±0.1pF, ±0.25pF	470	200	0.2±0.02	
MLAST042SCK3R6[WNA01]	TMK042 CJK3R6[D-W]	25	CJ C0J	3.6 p	±0.1pF, ±0.25pF	472	200	0.2±0.02	
MLAST042SCK3R7[WNA01]	TMK042 CJK3R7[D-W]	25	CJ C0J	3.7 p	±0.1pF, ±0.25pF	474	200	0.2±0.02	
MLAST042SCK3R8[WNA01]	TMK042 CJK3R8[D-W]	25	CJ C0J	3.8 p	±0.1pF, ±0.25pF	476	200	0.2±0.02	
MLAST042SCK3R9[WNA01]	TMK042 CJK3R9[D-W]	25	CJ C0J	3.9 p	±0.1pF, ±0.25pF	478	200	0.2±0.02	
MLAST042SCH040[WNA01]	TMK042 CH040[D-W]	25	CH C0H	4 p	±0.1pF, ±0.25pF	480	200	0.2±0.02	
MLAST042SCH4R1[WNA01]	TMK042 CH4R1[D-W]	25	CH C0H	4.1 p	±0.1pF, ±0.25pF	482	200	0.2±0.02	
MLAST042SCH4R2[WNA01]	TMK042 CH4R2[D-W]	25	CH C0H	4.2 p	±0.1pF, ±0.25pF	484	200	0.2±0.02	
MLAST042SCH4R3[WNA01]	TMK042 CH4R3[D-W]	25	CH C0H	4.3 p	±0.1pF, ±0.25pF	486	200	0.2±0.02	
MLAST042SCH4R4[WNA01]	TMK042 CH4R4[D-W]	25	CH C0H	4.4 p	±0.1pF, ±0.25pF	488	200	0.2±0.02	
MLAST042SCH4R5[WNA01]	TMK042 CH4R5[D-W]	25	CH C0H	4.5 p	±0.1pF, ±0.25pF	490	200	0.2±0.02	
MLAST042SCH4R6[WNA01]	TMK042 CH4R6[D-W]	25	CH C0H	4.6 p	±0.1pF, ±0.25pF	492	200	0.2±0.02	
MLAST042SCH4R7[WNA01]	TMK042 CH4R7[D-W]	25	CH C0H	4.7 p	±0.1pF, ±0.25pF	494	200	0.2±0.02	
MLAST042SCH4R8[WNA01]	TMK042 CH4R8[D-W]	25	CH C0H	4.8 p	±0.1pF, ±0.25pF	496	200	0.2±0.02	
MLAST042SCH4R9[WNA01]	TMK042 CH4R9[D-W]	25	CH C0H	4.9 p	±0.1pF, ±0.25pF	498	200	0.2±0.02	
MLAST042SCH050[WNA01]	TMK042 CH050[D-W]	25	CH C0H	5 p	±0.1pF, ±0.25pF	500	200	0.2±0.02	
MLAST042SCH5R1[WNA01]	TMK042 CH5R1[D-W]	25	CH C0H	5.1 p	±0.1pF, ±0.25pF, ±0.5pF	502	200	0.2±0.02	
MLAST042SCH5R2[WNA01]	TMK042 CH5R2[D-W]	25	CH C0H	5.2 p	±0.1pF, ±0.25pF, ±0.5pF	504	200	0.2±0.02	
MLAST042SCH5R3[WNA01]	TMK042 CH5R3[D-W]	25	CH C0H	5.3 p	±0.1pF, ±0.25pF, ±0.5pF	506	200	0.2±0.02	
MLAST042SCH5R4[WNA01]	TMK042 CH5R4[D-W]	25	CH C0H	5.4 p	±0.1pF, ±0.25pF, ±0.5pF	508	200	0.2±0.02	
MLAST042SCH5R5[WNA01]	TMK042 CH5R5[D-W]	25	CH C0H	5.5 p	±0.1pF, ±0.25pF, ±0.5pF	510	200	0.2±0.02	
MLAST042SCH5R6[WNA01]	TMK042 CH5R6[D-W]	25	CH C0H	5.6 p	±0.1pF, ±0.25pF, ±0.5pF	512	200	0.2±0.02	
MLAST042SCH5R7[WNA01]	TMK042 CH5R7[D-W]	25	CH C0H	5.7 p	±0.1pF, ±0.25pF, ±0.5pF	514	200	0.2±0.02	
MLAST042SCH5R8[WNA01]	TMK042 CH5R8[D-W]	25	CH C0H	5.8 p	±0.1pF, ±0.25pF, ±0.5pF	516	200	0.2±0.02	
MLAST042SCH5R9[WNA01]	TMK042 CH5R9[D-W]	25	CH C0H	5.9 p	±0.1pF, ±0.25pF, ±0.5pF	518	200	0.2±0.02	
MLAST042SCH060[WNA01]	TMK042 CH060[D-W]	25	CH C0H	6 p	±0.1pF, ±0.25pF, ±0.5pF	520	200	0.2±0.02	
MLAST042SCH6R1[WNA01]	TMK042 CH6R1[D-W]	25	CH C0H	6.1 p	±0.1pF, ±0.25pF, ±0.5pF	522	200	0.2±0.02	
MLAST042SCH6R2[WNA01]	TMK042 CH6R2[D-W]	25	CH C0H	6.2 p	±0.1pF, ±0.25pF, ±0.5pF	524	200	0.2±0.02	
MLAST042SCH6R3[WNA01]	TMK042 CH6R3[D-W]	25	CH C0H	6.3 p	±0.1pF, ±0.25pF, ±0.5pF	526	200	0.2±0.02	
MLAST042SCH6R4[WNA01]	TMK042 CH6R4[D-W]	25	CH C0H	6.4 p	±0.1pF, ±0.25pF, ±0.5pF	528	200	0.2±0.02	
MLAST042SCH6R5[WNA01]	TMK042 CH6R5[D-W]	25	CH C0H	6.5 p	±0.1pF, ±0.25pF, ±0.5pF	530	200	0.2±0.02	
MLAST042SCH6R6[WNA01]	TMK042 CH6R6[D-W]	25	CH C0H	6.6 p	±0.1pF, ±0.25pF, ±0.5pF	532	200	0.2±0.02	
MLAST042SCH6R7[WNA01]	TMK042 CH6R7[D-W]	25	CH C0H	6.7 p	±0.1pF, ±0.25pF, ±0.5pF	534	200	0.2±0.02	
MLAST042SCH6R8[WNA01]	TMK042 CH6R8[D-W]	25	CH C0H	6.8 p	±0.1pF, ±0.25pF, ±0.5pF	536	200	0.2±0.02	
MLAST042SCH6R9[WNA01]	TMK042 CH6R9[D-W]	25	CH C0H	6.9 p	±0.1pF, ±0.25pF, ±0.5pF	538	200	0.2±0.02	
MLAST042SCH070[WNA01]	TMK042 CH070[D-W]	25	CH C0H	7 p	±0.1pF, ±0.25pF, ±0.5pF	540	200	0.2±0.02	
MLAST042SCH7R1[WNA01]	TMK042 CH7R1[D-W]	25	CH C0H	7.1 p	±0.1pF, ±0.25pF, ±0.5pF	542	200	0.2±0.02	
MLAST042SCH7R2[WNA01]	TMK042 CH7R2[D-W]	25	CH C0H	7.2 p	±0.1pF, ±0.25pF, ±0.5pF	544	200	0.2±0.02	
MLAST042SCH7R3[WNA01]	TMK042 CH7R3[D-W]	25	CH C0H	7.3 p	±0.1pF, ±0.25pF, ±0.5pF	546	200	0.2±0.02	
MLAST042SCH7R4[WNA01]	TMK042 CH7R4[D-W]	25	CH C0H	7.4 p	±0.1pF, ±0.25pF, ±0.5pF	548	200	0.2±0.02	
MLAST042SCH7R5[WNA01]	TMK042 CH7R5[D-W]	25	CH C0H	7.5 p	±0.1pF, ±0.25pF, ±0.5pF	550	200	0.2±0.02	
MLAST042SCH7R6[WNA01]	TMK042 CH7R6[D-W]	25	CH C0H	7.6 p	±0.1pF, ±0.25pF, ±0.5pF	552	200	0.2±0.02	
MLAST042SCH7R7[WNA01]	TMK042 CH7R7[D-W]	25	CH C0H	7.7 p	±0.1pF, ±0.25pF, ±0.5pF	554	200	0.2±0.02	
MLAST042SCH7R8[WNA01]	TMK042 CH7R8[D-W]	25	CH C0H	7.8 p	±0.1pF, ±0.25pF, ±0.5pF	556	200	0.2±0.02	
MLAST042SCH7R9[WNA01]	TMK042 CH7R9[D-W]	25	CH C0H	7.9 p	±0.1pF, ±0.25pF, ±0.5pF	558	200	0.2±0.02	
MLAST042SCH080[WNA01]	TMK042 CH080[D-W]	25	CH C0H	8 p	±0.1pF, ±0.25pF, ±0.5pF	560	200	0.2±0.02	
MLAST042SCH8R1[WNA01]	TMK042 CH8R1[D-W]	25	CH C0H	8.1 p	±0.1pF, ±0.25pF, ±0.5pF	562	200	0.2±0.02	
MLAST042SCH8R2[WNA01]	TMK042 CH8R2[D-W]	25	CH C0H	8.2 p	±0.1pF, ±0.25pF, ±0.5pF	564	200	0.2±0.02	
MLAST042SCH8R3[WNA01]	TMK042 CH8R3[D-W]	25	CH C0H	8.3 p	±0.1pF, ±0.25pF, ±0.5pF	566	200	0.2±0.02	
MLAST042SCH8R4[WNA01]	TMK042 CH8R4[D-W]	25	CH C0H	8.4 p	±0.1pF, ±0.25pF, ±0.5pF	568	200	0.2±0.02	

\* This catalog contains the typical specification only due to the limitation of space. When you consider the purchase of our products, please check our specification. For details of each product (characteristics graph, reliability information, precautions for use, and so on), see our Web site (<http://www.ty-top.com/>).

## PARTS NUMBER

New part number	Old part number (for reference)	Rated voltage [V]	Temperature characteristics		Capacitance [F]	Capacitance tolerance	Q (at 1MHz) (min)	HTLT	Thickness*3 [mm]	Note
								Rated voltage x %		
MLAST042SCH8R5[WNA01	TMK042 CH8R5[D-W	25	CH	C0H	8.5 p	±0.1pF, ±0.25pF, ±0.5pF	570	200	0.2±0.02	
MLAST042SCH8R6[WNA01	TMK042 CH8R6[D-W	25	CH	C0H	8.6 p	±0.1pF, ±0.25pF, ±0.5pF	572	200	0.2±0.02	
MLAST042SCH8R7[WNA01	TMK042 CH8R7[D-W	25	CH	C0H	8.7 p	±0.1pF, ±0.25pF, ±0.5pF	574	200	0.2±0.02	
MLAST042SCH8R8[WNA01	TMK042 CH8R8[D-W	25	CH	C0H	8.8 p	±0.1pF, ±0.25pF, ±0.5pF	576	200	0.2±0.02	
MLAST042SCH8R9[WNA01	TMK042 CH8R9[D-W	25	CH	C0H	8.9 p	±0.1pF, ±0.25pF, ±0.5pF	578	200	0.2±0.02	
MLAST042SCH090[WNA01	TMK042 CH090[D-W	25	CH	C0H	9 p	±0.1pF, ±0.25pF, ±0.5pF	580	200	0.2±0.02	
MLAST042SCH9R1[WNA01	TMK042 CH9R1[D-W	25	CH	C0H	9.1 p	±0.1pF, ±0.25pF, ±0.5pF	582	200	0.2±0.02	
MLAST042SCH9R2[WNA01	TMK042 CH9R2[D-W	25	CH	C0H	9.2 p	±0.1pF, ±0.25pF, ±0.5pF	584	200	0.2±0.02	
MLAST042SCH9R3[WNA01	TMK042 CH9R3[D-W	25	CH	C0H	9.3 p	±0.1pF, ±0.25pF, ±0.5pF	586	200	0.2±0.02	
MLAST042SCH9R4[WNA01	TMK042 CH9R4[D-W	25	CH	C0H	9.4 p	±0.1pF, ±0.25pF, ±0.5pF	588	200	0.2±0.02	
MLAST042SCH9R5[WNA01	TMK042 CH9R5[D-W	25	CH	C0H	9.5 p	±0.1pF, ±0.25pF, ±0.5pF	590	200	0.2±0.02	
MLAST042SCH9R6[WNA01	TMK042 CH9R6[D-W	25	CH	C0H	9.6 p	±0.1pF, ±0.25pF, ±0.5pF	592	200	0.2±0.02	
MLAST042SCH9R7[WNA01	TMK042 CH9R7[D-W	25	CH	C0H	9.7 p	±0.1pF, ±0.25pF, ±0.5pF	594	200	0.2±0.02	
MLAST042SCH9R8[WNA01	TMK042 CH9R8[D-W	25	CH	C0H	9.8 p	±0.1pF, ±0.25pF, ±0.5pF	596	200	0.2±0.02	
MLAST042SCH9R9[WNA01	TMK042 CH9R9[D-W	25	CH	C0H	9.9 p	±0.1pF, ±0.25pF, ±0.5pF	598	200	0.2±0.02	
MLAST042SCH100D[WNA01	TMK042 CH100D[D-W	25	CH	C0H	10 p	±0.5pF	600	200	0.2±0.02	
MLAST042SCH110J[WNA01	TMK042 CH110J[D-W	25	CH	C0H	11 p	±5%	620	200	0.2±0.02	
MLAST042SCH120J[WNA01	TMK042 CH120J[D-W	25	CH	C0H	12 p	±5%	640	200	0.2±0.02	
MLAST042SCH130J[WNA01	TMK042 CH130J[D-W	25	CH	C0H	13 p	±5%	660	200	0.2±0.02	
MLAST042SCH150J[WNA01	TMK042 CH150J[D-W	25	CH	C0H	15 p	±5%	700	200	0.2±0.02	
MLAST042SCH160J[WNA01	TMK042 CH160J[C-W	25	CH	C0H	16 p	±5%	720	200	0.2±0.02	
MLAST042SCH180J[WNA01	TMK042 CH180J[C-W	25	CH	C0H	18 p	±5%	760	200	0.2±0.02	
MLAST042SCH200J[WNA01	TMK042 CH200J[C-W	25	CH	C0H	20 p	±5%	800	200	0.2±0.02	
MLAST042SCH220J[WNA01	TMK042 CH220J[C-W	25	CH	C0H	22 p	±5%	840	200	0.2±0.02	
MLAST042SCH240J[WNA01	TMK042 CH240J[C-W	25	CH	C0H	24 p	±5%	880	200	0.2±0.02	
MLAST042SCH270J[WNA01	TMK042 CH270J[C-W	25	CH	C0H	27 p	±5%	940	200	0.2±0.02	
MLAST042SCH300J[WNA01	TMK042 CH300J[C-W	25	CH	C0H	30 p	±5%	1000	200	0.2±0.02	
MLAST042SCH330J[WNA01	TMK042 CH330J[C-W	25	CH	C0H	33 p	±5%	1000	200	0.2±0.02	
MLAST042SCH360J[WNA01	TMK042 CH360J[C-W	25	CH	C0H	36 p	±5%	1000	200	0.2±0.02	
MLAST042SCH390J[WNA01	TMK042 CH390J[C-W	25	CH	C0H	39 p	±5%	1000	200	0.2±0.02	
MLAST042SCH430J[WNA01	TMK042 CH430J[C-W	25	CH	C0H	43 p	±5%	1000	200	0.2±0.02	
MLAST042SCH470J[WNA01	TMK042 CH470J[C-W	25	CH	C0H	47 p	±5%	1000	200	0.2±0.02	
MLAST042SCH510J[WNA01	TMK042 CH510J[C-W	25	CH	C0H	51 p	±5%	1000	200	0.2±0.02	
MLAST042SCH560J[WNA01	TMK042 CH560J[C-W	25	CH	C0H	56 p	±5%	1000	200	0.2±0.02	
MLAST042SCH620J[WNA01	TMK042 CH620J[C-W	25	CH	C0H	62 p	±5%	1000	200	0.2±0.02	
MLAST042SCH680J[WNA01	TMK042 CH680J[C-W	25	CH	C0H	68 p	±5%	1000	200	0.2±0.02	
MLAST042SCH750J[WNA01	TMK042 CH750J[C-W	25	CH	C0H	75 p	±5%	1000	200	0.2±0.02	
MLAST042SCH820J[WNA01	TMK042 CH820J[C-W	25	CH	C0H	82 p	±5%	1000	200	0.2±0.02	
MLAST042SCH910J[WNA01	TMK042 CH910J[C-W	25	CH	C0H	91 p	±5%	1000	200	0.2±0.02	
MLAST042SCH101J[WNA01	TMK042 CH101J[C-W	25	CH	C0H	100 p	±5%	1000	200	0.2±0.02	

【Temperature Characteristic  $C\Delta : C\Delta / C0\Delta (-55\sim +125^{\circ}C)$ 】 0.2mm thickness

New part number	Old part number (for reference)	Rated voltage [V]	Temperature characteristics		Capacitance [F]	Capacitance tolerance	Q (at 1MHz) (min)	HTLT	Thickness*3 [mm]	Note
								Rated voltage x %		
MLASE042SCK0R4[WNA01	EMK042 CK0R4[D-W	16	CK	C0K	0.4 p	±0.05pF, ±0.1pF, ±0.25pF	408	200	0.2±0.02	
MLASE042SCK0R5[WNA01	EMK042 CK0R5[D-W	16	CK	C0K	0.5 p	±0.05pF, ±0.1pF, ±0.25pF	410	200	0.2±0.02	
MLASE042SCK0R6[WNA01	EMK042 CK0R6[D-W	16	CK	C0K	0.6 p	±0.05pF, ±0.1pF, ±0.25pF	412	200	0.2±0.02	
MLASE042SCK0R7[WNA01	EMK042 CK0R7[D-W	16	CK	C0K	0.7 p	±0.05pF, ±0.1pF, ±0.25pF	414	200	0.2±0.02	
MLASE042SCK0R75[WNA01	EMK042 CKR75[D-W	16	CK	C0K	0.75 p	±0.05pF, ±0.1pF, ±0.25pF	415	200	0.2±0.02	
MLASE042SCK0R8[WNA01	EMK042 CK0R8[D-W	16	CK	C0K	0.8 p	±0.05pF, ±0.1pF, ±0.25pF	416	200	0.2±0.02	
MLASE042SCK0R9[WNA01	EMK042 CK0R9[D-W	16	CK	C0K	0.9 p	±0.05pF, ±0.1pF, ±0.25pF	418	200	0.2±0.02	
MLASE042SCK010[WNA01	EMK042 CK010[D-W	16	CK	C0K	1 p	±0.05pF, ±0.1pF, ±0.25pF	420	200	0.2±0.02	
MLASE042SCK1R1[WNA01	EMK042 CK1R1[D-W	16	CK	C0K	1.1 p	±0.05pF, ±0.1pF, ±0.25pF	422	200	0.2±0.02	
MLASE042SCK1R2[WNA01	EMK042 CK1R2[D-W	16	CK	C0K	1.2 p	±0.05pF, ±0.1pF, ±0.25pF	424	200	0.2±0.02	
MLASE042SCK1R3[WNA01	EMK042 CK1R3[D-W	16	CK	C0K	1.3 p	±0.05pF, ±0.1pF, ±0.25pF	426	200	0.2±0.02	
MLASE042SCK1R4[WNA01	EMK042 CK1R4[D-W	16	CK	C0K	1.4 p	±0.05pF, ±0.1pF, ±0.25pF	428	200	0.2±0.02	
MLASE042SCK1R5[WNA01	EMK042 CK1R5[D-W	16	CK	C0K	1.5 p	±0.05pF, ±0.1pF, ±0.25pF	430	200	0.2±0.02	
MLASE042SCK1R6[WNA01	EMK042 CK1R6[D-W	16	CK	C0K	1.6 p	±0.05pF, ±0.1pF, ±0.25pF	432	200	0.2±0.02	
MLASE042SCK1R7[WNA01	EMK042 CK1R7[D-W	16	CK	C0K	1.7 p	±0.05pF, ±0.1pF, ±0.25pF	434	200	0.2±0.02	
MLASE042SCK1R8[WNA01	EMK042 CK1R8[D-W	16	CK	C0K	1.8 p	±0.05pF, ±0.1pF, ±0.25pF	436	200	0.2±0.02	
MLASE042SCK1R9[WNA01	EMK042 CK1R9[D-W	16	CK	C0K	1.9 p	±0.05pF, ±0.1pF, ±0.25pF	438	200	0.2±0.02	
MLASE042SCK020[WNA01	EMK042 CK020[D-W	16	CK	C0K	2 p	±0.05pF, ±0.1pF, ±0.25pF	440	200	0.2±0.02	
MLASE042SCK2R1[WNA01	EMK042 CK2R1[D-W	16	CK	C0K	2.1 p	±0.05pF, ±0.1pF, ±0.25pF	442	200	0.2±0.02	
MLASE042SCK2R2[WNA01	EMK042 CK2R2[D-W	16	CK	C0K	2.2 p	±0.05pF, ±0.1pF, ±0.25pF	444	200	0.2±0.02	
MLASE042SCK2R3[WNA01	EMK042 CK2R3[D-W	16	CK	C0K	2.3 p	±0.05pF, ±0.1pF, ±0.25pF	446	200	0.2±0.02	
MLASE042SCK2R4[WNA01	EMK042 CK2R4[D-W	16	CK	C0K	2.4 p	±0.05pF, ±0.1pF, ±0.25pF	448	200	0.2±0.02	
MLASE042SCK2R5[WNA01	EMK042 CK2R5[D-W	16	CK	C0K	2.5 p	±0.05pF, ±0.1pF, ±0.25pF	450	200	0.2±0.02	
MLASE042SCK2R6[WNA01	EMK042 CK2R6[D-W	16	CK	C0K	2.6 p	±0.05pF, ±0.1pF, ±0.25pF	452	200	0.2±0.02	
MLASE042SCK2R7[WNA01	EMK042 CK2R7[D-W	16	CK	C0K	2.7 p	±0.05pF, ±0.1pF, ±0.25pF	454	200	0.2±0.02	
MLASE042SCK2R8[WNA01	EMK042 CK2R8[D-W	16	CK	C0K	2.8 p	±0.05pF, ±0.1pF, ±0.25pF	456	200	0.2±0.02	
MLASE042SCK2R9[WNA01	EMK042 CK2R9[D-W	16	CK	C0K	2.9 p	±0.05pF, ±0.1pF, ±0.25pF	458	200	0.2±0.02	
MLASE042SCK030[WNA01	EMK042 CK030[D-W	16	CJ	C0J	3 p	±0.05pF, ±0.1pF, ±0.25pF	460	200	0.2±0.02	
MLASE042SCK3R1[WNA01	EMK042 C3R1[D-W	16	CJ	C0J	3.1 p	±0.1pF, ±0.25pF	462	200	0.2±0.02	
MLASE042SCK3R2[WNA01	EMK042 C3R2[D-W	16	CJ	C0J	3.2 p	±0.1pF, ±0.25pF	464	200	0.2±0.02	
MLASE042SCK3R3[WNA01	EMK042 C3R3[D-W	16	CJ	C0J	3.3 p	±0.1pF, ±0.25pF	466	200	0.2±0.02	
MLASE042SCK3R4[WNA01	EMK042 C3R4[D-W	16	CJ	C0J	3.4 p	±0.1pF, ±0.25pF	468	200	0.2±0.02	
MLASE042SCK3R5[WNA01	EMK042 C3R5[D-W	16	CJ	C0J	3.5 p	±0.1pF, ±0.25pF	470	200	0.2±0.02	
MLASE042SCK3R6[WNA01	EMK042 C3R6[D-W	16	CJ	C0J	3.6 p	±0.1pF, ±0.25pF	472	200	0.2±0.02	
MLASE042SCK3R7[WNA01	EMK042 C3R7[D-W	16	CJ	C0J	3.7 p	±0.1pF, ±0.25pF	474	200	0.2±0.02	
MLASE042SCK3R8[WNA01	EMK042 C3R8[D-W	16	CJ	C0J	3.8 p	±0.1pF, ±0.25pF	476	200	0.2±0.02	
MLASE042SCK3R9[WNA01	EMK042 C3R9[D-W	16	CJ	C0J	3.9 p	±0.1pF, ±0.25pF	478	200	0.2±0.02	
MLASE042SCH040[WNA01	EMK042 CH040[D-W	16	CH	C0H	4 p	±0.1pF, ±0.25pF	480	200	0.2±0.02	
MLASE042SCH4R1[WNA01	EMK042 CH4R1[D-W	16	CH	C0H	4.1 p	±0.1pF, ±0.25pF	482	200	0.2±0.02	
MLASE042SCH4R2[WNA01	EMK042 CH4R2[D-W	16	CH	C0H	4.2 p	±0.1pF, ±0.25pF	484	200	0.2±0.02	
MLASE042SCH4R3[WNA01	EMK042 CH4R3[D-W	16	CH	C0H	4.3 p	±0.1pF, ±0.25pF	486	200	0.2±0.02	

▶ This catalog contains the typical specification only due to the limitation of space. When you consider the purchase of our products, please check our specification.  
For details of each product (characteristics graph, reliability information, precautions for use, and so on), see our Web site (<http://www.ty-top.com/>).

CATALOG 2022

## PARTS NUMBER

New part number	Old part number (for reference)	Rated voltage [V]	Temperature characteristics		Capacitance [F]	Capacitance tolerance	Q (at 1MHz) (min)	HTLT	Thickness*3 [mm]	Note
								Rated voltage x %		
MLASE042SCH4R4[WNA01	EMK042 CH4R4[D-W	16	CH	C0H	4.4 p	±0.1pF, ±0.25pF	488	200	0.2±0.02	
MLASE042SCH4R5[WNA01	EMK042 CH4R5[D-W	16	CH	C0H	4.5 p	±0.1pF, ±0.25pF	490	200	0.2±0.02	
MLASE042SCH4R6[WNA01	EMK042 CH4R6[D-W	16	CH	C0H	4.6 p	±0.1pF, ±0.25pF	492	200	0.2±0.02	
MLASE042SCH4R7[WNA01	EMK042 CH4R7[D-W	16	CH	C0H	4.7 p	±0.1pF, ±0.25pF	494	200	0.2±0.02	
MLASE042SCH4R8[WNA01	EMK042 CH4R8[D-W	16	CH	C0H	4.8 p	±0.1pF, ±0.25pF	496	200	0.2±0.02	
MLASE042SCH4R9[WNA01	EMK042 CH4R9[D-W	16	CH	C0H	4.9 p	±0.1pF, ±0.25pF	498	200	0.2±0.02	
MLASE042SCH050[WNA01	EMK042 CH050[D-W	16	CH	C0H	5 p	±0.1pF, ±0.25pF	500	200	0.2±0.02	
MLASE042SCH5R1[WNA01	EMK042 CH5R1[D-W	16	CH	C0H	5.1 p	±0.1pF, ±0.25pF, ±0.5pF	502	200	0.2±0.02	
MLASE042SCH5R2[WNA01	EMK042 CH5R2[D-W	16	CH	C0H	5.2 p	±0.1pF, ±0.25pF, ±0.5pF	504	200	0.2±0.02	
MLASE042SCH5R3[WNA01	EMK042 CH5R3[D-W	16	CH	C0H	5.3 p	±0.1pF, ±0.25pF, ±0.5pF	506	200	0.2±0.02	
MLASE042SCH5R4[WNA01	EMK042 CH5R4[D-W	16	CH	C0H	5.4 p	±0.1pF, ±0.25pF, ±0.5pF	508	200	0.2±0.02	
MLASE042SCH5R5[WNA01	EMK042 CH5R5[D-W	16	CH	C0H	5.5 p	±0.1pF, ±0.25pF, ±0.5pF	510	200	0.2±0.02	
MLASE042SCH5R6[WNA01	EMK042 CH5R6[D-W	16	CH	C0H	5.6 p	±0.1pF, ±0.25pF, ±0.5pF	512	200	0.2±0.02	
MLASE042SCH5R7[WNA01	EMK042 CH5R7[D-W	16	CH	C0H	5.7 p	±0.1pF, ±0.25pF, ±0.5pF	514	200	0.2±0.02	
MLASE042SCH5R8[WNA01	EMK042 CH5R8[D-W	16	CH	C0H	5.8 p	±0.1pF, ±0.25pF, ±0.5pF	516	200	0.2±0.02	
MLASE042SCH5R9[WNA01	EMK042 CH5R9[D-W	16	CH	C0H	5.9 p	±0.1pF, ±0.25pF, ±0.5pF	518	200	0.2±0.02	
MLASE042SCH060[WNA01	EMK042 CH060[D-W	16	CH	C0H	6 p	±0.1pF, ±0.25pF, ±0.5pF	520	200	0.2±0.02	
MLASE042SCH6R1[WNA01	EMK042 CH6R1[D-W	16	CH	C0H	6.1 p	±0.1pF, ±0.25pF, ±0.5pF	522	200	0.2±0.02	
MLASE042SCH6R2[WNA01	EMK042 CH6R2[D-W	16	CH	C0H	6.2 p	±0.1pF, ±0.25pF, ±0.5pF	524	200	0.2±0.02	
MLASE042SCH6R3[WNA01	EMK042 CH6R3[D-W	16	CH	C0H	6.3 p	±0.1pF, ±0.25pF, ±0.5pF	526	200	0.2±0.02	
MLASE042SCH6R4[WNA01	EMK042 CH6R4[D-W	16	CH	C0H	6.4 p	±0.1pF, ±0.25pF, ±0.5pF	528	200	0.2±0.02	
MLASE042SCH6R5[WNA01	EMK042 CH6R5[D-W	16	CH	C0H	6.5 p	±0.1pF, ±0.25pF, ±0.5pF	530	200	0.2±0.02	
MLASE042SCH6R6[WNA01	EMK042 CH6R6[D-W	16	CH	C0H	6.6 p	±0.1pF, ±0.25pF, ±0.5pF	532	200	0.2±0.02	
MLASE042SCH6R7[WNA01	EMK042 CH6R7[D-W	16	CH	C0H	6.7 p	±0.1pF, ±0.25pF, ±0.5pF	534	200	0.2±0.02	
MLASE042SCH6R8[WNA01	EMK042 CH6R8[D-W	16	CH	C0H	6.8 p	±0.1pF, ±0.25pF, ±0.5pF	536	200	0.2±0.02	
MLASE042SCH6R9[WNA01	EMK042 CH6R9[D-W	16	CH	C0H	6.9 p	±0.1pF, ±0.25pF, ±0.5pF	538	200	0.2±0.02	
MLASE042SCH070[WNA01	EMK042 CH070[D-W	16	CH	C0H	7 p	±0.1pF, ±0.25pF, ±0.5pF	540	200	0.2±0.02	
MLASE042SCH7R1[WNA01	EMK042 CH7R1[D-W	16	CH	C0H	7.1 p	±0.1pF, ±0.25pF, ±0.5pF	542	200	0.2±0.02	
MLASE042SCH7R2[WNA01	EMK042 CH7R2[D-W	16	CH	C0H	7.2 p	±0.1pF, ±0.25pF, ±0.5pF	544	200	0.2±0.02	
MLASE042SCH7R3[WNA01	EMK042 CH7R3[D-W	16	CH	C0H	7.3 p	±0.1pF, ±0.25pF, ±0.5pF	546	200	0.2±0.02	
MLASE042SCH7R4[WNA01	EMK042 CH7R4[D-W	16	CH	C0H	7.4 p	±0.1pF, ±0.25pF, ±0.5pF	548	200	0.2±0.02	
MLASE042SCH7R5[WNA01	EMK042 CH7R5[D-W	16	CH	C0H	7.5 p	±0.1pF, ±0.25pF, ±0.5pF	550	200	0.2±0.02	
MLASE042SCH7R6[WNA01	EMK042 CH7R6[D-W	16	CH	C0H	7.6 p	±0.1pF, ±0.25pF, ±0.5pF	552	200	0.2±0.02	
MLASE042SCH7R7[WNA01	EMK042 CH7R7[D-W	16	CH	C0H	7.7 p	±0.1pF, ±0.25pF, ±0.5pF	554	200	0.2±0.02	
MLASE042SCH7R8[WNA01	EMK042 CH7R8[D-W	16	CH	C0H	7.8 p	±0.1pF, ±0.25pF, ±0.5pF	556	200	0.2±0.02	
MLASE042SCH7R9[WNA01	EMK042 CH7R9[D-W	16	CH	C0H	7.9 p	±0.1pF, ±0.25pF, ±0.5pF	558	200	0.2±0.02	
MLASE042SCH080[WNA01	EMK042 CH080[D-W	16	CH	C0H	8 p	±0.1pF, ±0.25pF, ±0.5pF	560	200	0.2±0.02	
MLASE042SCH8R1[WNA01	EMK042 CH8R1[D-W	16	CH	C0H	8.1 p	±0.1pF, ±0.25pF, ±0.5pF	562	200	0.2±0.02	
MLASE042SCH8R2[WNA01	EMK042 CH8R2[D-W	16	CH	C0H	8.2 p	±0.1pF, ±0.25pF, ±0.5pF	564	200	0.2±0.02	
MLASE042SCH8R3[WNA01	EMK042 CH8R3[D-W	16	CH	C0H	8.3 p	±0.1pF, ±0.25pF, ±0.5pF	566	200	0.2±0.02	
MLASE042SCH8R4[WNA01	EMK042 CH8R4[D-W	16	CH	C0H	8.4 p	±0.1pF, ±0.25pF, ±0.5pF	568	200	0.2±0.02	
MLASE042SCH8R5[WNA01	EMK042 CH8R5[D-W	16	CH	C0H	8.5 p	±0.1pF, ±0.25pF, ±0.5pF	570	200	0.2±0.02	
MLASE042SCH8R6[WNA01	EMK042 CH8R6[D-W	16	CH	C0H	8.6 p	±0.1pF, ±0.25pF, ±0.5pF	572	200	0.2±0.02	
MLASE042SCH8R7[WNA01	EMK042 CH8R7[D-W	16	CH	C0H	8.7 p	±0.1pF, ±0.25pF, ±0.5pF	574	200	0.2±0.02	
MLASE042SCH8R8[WNA01	EMK042 CH8R8[D-W	16	CH	C0H	8.8 p	±0.1pF, ±0.25pF, ±0.5pF	576	200	0.2±0.02	
MLASE042SCH8R9[WNA01	EMK042 CH8R9[D-W	16	CH	C0H	8.9 p	±0.1pF, ±0.25pF, ±0.5pF	578	200	0.2±0.02	
MLASE042SCH090[WNA01	EMK042 CH090[D-W	16	CH	C0H	9 p	±0.1pF, ±0.25pF, ±0.5pF	580	200	0.2±0.02	
MLASE042SCH9R1[WNA01	EMK042 CH9R1[D-W	16	CH	C0H	9.1 p	±0.1pF, ±0.25pF, ±0.5pF	582	200	0.2±0.02	
MLASE042SCH9R2[WNA01	EMK042 CH9R2[D-W	16	CH	C0H	9.2 p	±0.1pF, ±0.25pF, ±0.5pF	584	200	0.2±0.02	
MLASE042SCH9R3[WNA01	EMK042 CH9R3[D-W	16	CH	C0H	9.3 p	±0.1pF, ±0.25pF, ±0.5pF	586	200	0.2±0.02	
MLASE042SCH9R4[WNA01	EMK042 CH9R4[D-W	16	CH	C0H	9.4 p	±0.1pF, ±0.25pF, ±0.5pF	588	200	0.2±0.02	
MLASE042SCH9R5[WNA01	EMK042 CH9R5[D-W	16	CH	C0H	9.5 p	±0.1pF, ±0.25pF, ±0.5pF	590	200	0.2±0.02	
MLASE042SCH9R6[WNA01	EMK042 CH9R6[D-W	16	CH	C0H	9.6 p	±0.1pF, ±0.25pF, ±0.5pF	592	200	0.2±0.02	
MLASE042SCH9R7[WNA01	EMK042 CH9R7[D-W	16	CH	C0H	9.7 p	±0.1pF, ±0.25pF, ±0.5pF	594	200	0.2±0.02	
MLASE042SCH9R8[WNA01	EMK042 CH9R8[D-W	16	CH	C0H	9.8 p	±0.1pF, ±0.25pF, ±0.5pF	596	200	0.2±0.02	
MLASE042SCH9R9[WNA01	EMK042 CH9R9[D-W	16	CH	C0H	9.9 p	±0.1pF, ±0.25pF, ±0.5pF	598	200	0.2±0.02	
MLASE042SCH100D[WNA01	EMK042 CH100D-W	16	CH	C0H	10 p	±5%	600	200	0.2±0.02	
MLASE042SCH110JWNA01	EMK042 CH110JD-W	16	CH	C0H	11 p	±5%	620	200	0.2±0.02	
MLASE042SCH120JWNA01	EMK042 CH120JD-W	16	CH	C0H	12 p	±5%	640	200	0.2±0.02	
MLASE042SCH130JWNA01	EMK042 CH130JD-W	16	CH	C0H	13 p	±5%	660	200	0.2±0.02	
MLASE042SCH150JWNA01	EMK042 CH150JD-W	16	CH	C0H	15 p	±5%	700	200	0.2±0.02	
MLASE042SCH160JWNA01	EMK042 CH160JC-W	16	CH	C0H	16 p	±5%	720	200	0.2±0.02	
MLASE042SCH180JWNA01	EMK042 CH180JC-W	16	CH	C0H	18 p	±5%	760	200	0.2±0.02	
MLASE042SCH200JWNA01	EMK042 CH200JC-W	16	CH	C0H	20 p	±5%	800	200	0.2±0.02	
MLASE042SCH220JWNA01	EMK042 CH220JC-W	16	CH	C0H	22 p	±5%	840	200	0.2±0.02	
MLASE042SCH240JWNA01	EMK042 CH240JC-W	16	CH	C0H	24 p	±5%	880	200	0.2±0.02	
MLASE042SCH270JWNA01	EMK042 CH270JC-W	16	CH	C0H	27 p	±5%	940	200	0.2±0.02	
MLASE042SCH300JWNA01	EMK042 CH300JC-W	16	CH	C0H	30 p	±5%	1000	200	0.2±0.02	
MLASE042SCH330JWNA01	EMK042 CH330JC-W	16	CH	C0H	33 p	±5%	1000	200	0.2±0.02	
MLASE042SCH360JWNA01	EMK042 CH360JC-W	16	CH	C0H	36 p	±5%	1000	200	0.2±0.02	
MLASE042SCH390JWNA01	EMK042 CH390JC-W	16	CH	C0H	39 p	±5%	1000	200	0.2±0.02	
MLASE042SCH430JWNA01	EMK042 CH430JC-W	16	CH	C0H	43 p	±5%	1000	200	0.2±0.02	
MLASE042SCH470JWNA01	EMK042 CH470JC-W	16	CH	C0H	47 p	±5%	1000	200	0.2±0.02	
MLASE042SCH510JWNA01	EMK042 CH510JC-W	16	CH	C0H	51 p	±5%	1000	200	0.2±0.02	
MLASE042SCH560JWNA01	EMK042 CH560JC-W	16	CH	C0H	56 p	±5%	1000	200	0.2±0.02	
MLASE042SCH620JWNA01	EMK042 CH620JC-W	16	CH	C0H	62 p	±5%	1000	200	0.2±0.02	
MLASE042SCH680JWNA01	EMK042 CH680JC-W	16	CH	C0H	68 p	±5%	1000	200	0.2±0.02	
MLASE042SCH750JWNA01	EMK042 CH750JC-W	16	CH	C0H	75 p	±5%	1000	200	0.2±0.02	
MLASE042SCH820JWNA01	EMK042 CH820JC-W	16	CH	C0H	82 p	±5%	1000	200	0.2±0.02	
MLASE042SCH910JWNA01	EMK042 CH910JC-W	16	CH	C0H	91 p	±5%	1000	200	0.2±0.02	
MLASE042SCH101JWNA01	EMK042 CH101JC-W	16	CH	C0H	100 p	±5%	1000	200	0.2±0.02	
MLASE042SCH221JWNA01	EMK042 CH221JC-W	16	CH	C0H	220 p	±5%	1000	200	0.2±0.02	
MLASE042SCH241JWNA01	EMK042 CH241JC-W	16	CH	C0H	240 p	±5%	1000	200	0.2±0.02	
MLASE042SCH271JWNA01	EMK042 CH271JC-W	16	CH	C0H	270 p	±5%	1000	200	0.2±0.02	
MLASE042SCH331JWNA01	EMK042 CH331JC-W	16	CH	C0H	330 p	±5%	1000	200	0.2±0.02	

\* This catalog contains the typical specification only due to the limitation of space. When you consider the purchase of our products, please check our specification.  
For details of each product (characteristics graph, reliability information, precautions for use, and so on), see our Web site (<http://www.ty-top.com/>).



■ PARTS NUMBER

【Temperature Characteristic CG : CG/C0G (−55~+125°C)】 0.2mm thickness

New part number	Old part number (for reference)	Rated voltage [V]	Temperature characteristics	Capacitance [F]	Capacitance tolerance	Q (at 1MHz) (min)	HTLT	Thickness*3 [mm]	Note
							Rated voltage x %		
MLAST042SCG0R4[WNA01	TMK042 CG0R4[D-W	25	CG C0G	0.4 p	±0.05pF,±0.1pF,±0.25pF	408	200	0.2±0.02	
MLAST042SCG0R5[WNA01	TMK042 CG0R5[D-W	25	CG C0G	0.5 p	±0.05pF,±0.1pF,±0.25pF	410	200	0.2±0.02	
MLAST042SCG0R6[WNA01	TMK042 CG0R6[D-W	25	CG C0G	0.6 p	±0.05pF,±0.1pF,±0.25pF	412	200	0.2±0.02	
MLAST042SCG0R7[WNA01	TMK042 CG0R7[D-W	25	CG C0G	0.7 p	±0.05pF,±0.1pF,±0.25pF	414	200	0.2±0.02	
MLAST042SCGR75[WNA01	TMK042 CGR75[D-W	25	CG C0G	0.75 p	±0.05pF,±0.1pF,±0.25pF	415	200	0.2±0.02	
MLAST042SCG0R8[WNA01	TMK042 CG0R8[D-W	25	CG C0G	0.8 p	±0.05pF,±0.1pF,±0.25pF	416	200	0.2±0.02	
MLAST042SCG0R9[WNA01	TMK042 CG0R9[D-W	25	CG C0G	0.9 p	±0.05pF,±0.1pF,±0.25pF	418	200	0.2±0.02	
MLAST042SCG010[WNA01	TMK042 CG010[D-W	25	CG C0G	1 p	±0.05pF,±0.1pF,±0.25pF	420	200	0.2±0.02	
MLAST042SCG1R1[WNA01	TMK042 CG1R1[D-W	25	CG C0G	1.1 p	±0.05pF,±0.1pF,±0.25pF	422	200	0.2±0.02	
MLAST042SCG1R2[WNA01	TMK042 CG1R2[D-W	25	CG C0G	1.2 p	±0.05pF,±0.1pF,±0.25pF	424	200	0.2±0.02	
MLAST042SCG1R3[WNA01	TMK042 CG1R3[D-W	25	CG C0G	1.3 p	±0.05pF,±0.1pF,±0.25pF	426	200	0.2±0.02	
MLAST042SCG1R4[WNA01	TMK042 CG1R4[D-W	25	CG C0G	1.4 p	±0.05pF,±0.1pF,±0.25pF	428	200	0.2±0.02	
MLAST042SCG1R5[WNA01	TMK042 CG1R5[D-W	25	CG C0G	1.5 p	±0.05pF,±0.1pF,±0.25pF	430	200	0.2±0.02	
MLAST042SCG1R6[WNA01	TMK042 CG1R6[D-W	25	CG C0G	1.6 p	±0.05pF,±0.1pF,±0.25pF	432	200	0.2±0.02	
MLAST042SCG1R7[WNA01	TMK042 CG1R7[D-W	25	CG C0G	1.7 p	±0.05pF,±0.1pF,±0.25pF	434	200	0.2±0.02	
MLAST042SCG1R8[WNA01	TMK042 CG1R8[D-W	25	CG C0G	1.8 p	±0.05pF,±0.1pF,±0.25pF	436	200	0.2±0.02	
MLAST042SCG1R9[WNA01	TMK042 CG1R9[D-W	25	CG C0G	1.9 p	±0.05pF,±0.1pF,±0.25pF	438	200	0.2±0.02	
MLAST042SCG020[WNA01	TMK042 CG020[D-W	25	CG C0G	2 p	±0.05pF,±0.1pF,±0.25pF	440	200	0.2±0.02	
MLAST042SCG2R1[WNA01	TMK042 CG2R1[D-W	25	CG C0G	2.1 p	±0.05pF,±0.1pF,±0.25pF	442	200	0.2±0.02	
MLAST042SCG2R2[WNA01	TMK042 CG2R2[D-W	25	CG C0G	2.2 p	±0.05pF,±0.1pF,±0.25pF	444	200	0.2±0.02	
MLAST042SCG2R3[WNA01	TMK042 CG2R3[D-W	25	CG C0G	2.3 p	±0.05pF,±0.1pF,±0.25pF	446	200	0.2±0.02	
MLAST042SCG2R4[WNA01	TMK042 CG2R4[D-W	25	CG C0G	2.4 p	±0.05pF,±0.1pF,±0.25pF	448	200	0.2±0.02	
MLAST042SCG2R5[WNA01	TMK042 CG2R5[D-W	25	CG C0G	2.5 p	±0.05pF,±0.1pF,±0.25pF	450	200	0.2±0.02	
MLAST042SCG2R6[WNA01	TMK042 CG2R6[D-W	25	CG C0G	2.6 p	±0.05pF,±0.1pF,±0.25pF	452	200	0.2±0.02	
MLAST042SCG2R7[WNA01	TMK042 CG2R7[D-W	25	CG C0G	2.7 p	±0.05pF,±0.1pF,±0.25pF	454	200	0.2±0.02	
MLAST042SCG2R8[WNA01	TMK042 CG2R8[D-W	25	CG C0G	2.8 p	±0.05pF,±0.1pF,±0.25pF	456	200	0.2±0.02	
MLAST042SCG2R9[WNA01	TMK042 CG2R9[D-W	25	CG C0G	2.9 p	±0.05pF,±0.1pF,±0.25pF	458	200	0.2±0.02	
MLAST042SCG030[WNA01	TMK042 CG030[D-W	25	CG C0G	3 p	±0.05pF,±0.1pF,±0.25pF	460	200	0.2±0.02	
MLAST042SCG3R1[WNA01	TMK042 CG3R1[D-W	25	CG C0G	3.1 p	±0.1pF,±0.25pF	462	200	0.2±0.02	
MLAST042SCG3R2[WNA01	TMK042 CG3R2[D-W	25	CG C0G	3.2 p	±0.1pF,±0.25pF	464	200	0.2±0.02	
MLAST042SCG3R3[WNA01	TMK042 CG3R3[D-W	25	CG C0G	3.3 p	±0.1pF,±0.25pF	466	200	0.2±0.02	
MLAST042SCG3R4[WNA01	TMK042 CG3R4[D-W	25	CG C0G	3.4 p	±0.1pF,±0.25pF	468	200	0.2±0.02	
MLAST042SCG3R5[WNA01	TMK042 CG3R5[D-W	25	CG C0G	3.5 p	±0.1pF,±0.25pF	470	200	0.2±0.02	
MLAST042SCG3R6[WNA01	TMK042 CG3R6[D-W	25	CG C0G	3.6 p	±0.1pF,±0.25pF	472	200	0.2±0.02	
MLAST042SCG3R7[WNA01	TMK042 CG3R7[D-W	25	CG C0G	3.7 p	±0.1pF,±0.25pF	474	200	0.2±0.02	
MLAST042SCG3R8[WNA01	TMK042 CG3R8[D-W	25	CG C0G	3.8 p	±0.1pF,±0.25pF	476	200	0.2±0.02	
MLAST042SCG3R9[WNA01	TMK042 CG3R9[D-W	25	CG C0G	3.9 p	±0.1pF,±0.25pF	478	200	0.2±0.02	
MLAST042SCG040[WNA01	TMK042 CG040[D-W	25	CG C0G	4 p	±0.1pF,±0.25pF	480	200	0.2±0.02	
MLAST042SCG4R1[WNA01	TMK042 CG4R1[D-W	25	CG C0G	4.1 p	±0.1pF,±0.25pF	482	200	0.2±0.02	
MLAST042SCG4R2[WNA01	TMK042 CG4R2[D-W	25	CG C0G	4.2 p	±0.1pF,±0.25pF	484	200	0.2±0.02	
MLAST042SCG4R3[WNA01	TMK042 CG4R3[D-W	25	CG C0G	4.3 p	±0.1pF,±0.25pF	486	200	0.2±0.02	
MLAST042SCG4R4[WNA01	TMK042 CG4R4[D-W	25	CG C0G	4.4 p	±0.1pF,±0.25pF	488	200	0.2±0.02	
MLAST042SCG4R5[WNA01	TMK042 CG4R5[D-W	25	CG C0G	4.5 p	±0.1pF,±0.25pF	490	200	0.2±0.02	
MLAST042SCG4R6[WNA01	TMK042 CG4R6[D-W	25	CG C0G	4.6 p	±0.1pF,±0.25pF	492	200	0.2±0.02	
MLAST042SCG4R7[WNA01	TMK042 CG4R7[D-W	25	CG C0G	4.7 p	±0.1pF,±0.25pF	494	200	0.2±0.02	
MLAST042SCG4R8[WNA01	TMK042 CG4R8[D-W	25	CG C0G	4.8 p	±0.1pF,±0.25pF	496	200	0.2±0.02	
MLAST042SCG4R9[WNA01	TMK042 CG4R9[D-W	25	CG C0G	4.9 p	±0.1pF,±0.25pF	498	200	0.2±0.02	
MLAST042SCG050[WNA01	TMK042 CG050[D-W	25	CG C0G	5 p	±0.1pF,±0.25pF	500	200	0.2±0.02	
MLAST042SCG5R1[WNA01	TMK042 CG5R1[D-W	25	CG C0G	5.1 p	±0.1pF,±0.25pF,±0.5pF	502	200	0.2±0.02	
MLAST042SCG5R2[WNA01	TMK042 CG5R2[D-W	25	CG C0G	5.2 p	±0.1pF,±0.25pF,±0.5pF	504	200	0.2±0.02	
MLAST042SCG5R3[WNA01	TMK042 CG5R3[D-W	25	CG C0G	5.3 p	±0.1pF,±0.25pF,±0.5pF	506	200	0.2±0.02	
MLAST042SCG5R4[WNA01	TMK042 CG5R4[D-W	25	CG C0G	5.4 p	±0.1pF,±0.25pF,±0.5pF	508	200	0.2±0.02	
MLAST042SCG5R5[WNA01	TMK042 CG5R5[D-W	25	CG C0G	5.5 p	±0.1pF,±0.25pF,±0.5pF	510	200	0.2±0.02	
MLAST042SCG5R6[WNA01	TMK042 CG5R6[D-W	25	CG C0G	5.6 p	±0.1pF,±0.25pF,±0.5pF	512	200	0.2±0.02	
MLAST042SCG5R7[WNA01	TMK042 CG5R7[D-W	25	CG C0G	5.7 p	±0.1pF,±0.25pF,±0.5pF	514	200	0.2±0.02	
MLAST042SCG5R8[WNA01	TMK042 CG5R8[D-W	25	CG C0G	5.8 p	±0.1pF,±0.25pF,±0.5pF	516	200	0.2±0.02	
MLAST042SCG5R9[WNA01	TMK042 CG5R9[D-W	25	CG C0G	5.9 p	±0.1pF,±0.25pF,±0.5pF	518	200	0.2±0.02	
MLAST042SCG060[WNA01	TMK042 CG060[D-W	25	CG C0G	6 p	±0.1pF,±0.25pF,±0.5pF	520	200	0.2±0.02	
MLAST042SCG6R1[WNA01	TMK042 CG6R1[D-W	25	CG C0G	6.1 p	±0.1pF,±0.25pF,±0.5pF	522	200	0.2±0.02	
MLAST042SCG6R2[WNA01	TMK042 CG6R2[D-W	25	CG C0G	6.2 p	±0.1pF,±0.25pF,±0.5pF	524	200	0.2±0.02	
MLAST042SCG6R3[WNA01	TMK042 CG6R3[D-W	25	CG C0G	6.3 p	±0.1pF,±0.25pF,±0.5pF	526	200	0.2±0.02	
MLAST042SCG6R4[WNA01	TMK042 CG6R4[D-W	25	CG C0G	6.4 p	±0.1pF,±0.25pF,±0.5pF	528	200	0.2±0.02	
MLAST042SCG6R5[WNA01	TMK042 CG6R5[D-W	25	CG C0G	6.5 p	±0.1pF,±0.25pF,±0.5pF	530	200	0.2±0.02	
MLAST042SCG6R6[WNA01	TMK042 CG6R6[D-W	25	CG C0G	6.6 p	±0.1pF,±0.25pF,±0.5pF	532	200	0.2±0.02	
MLAST042SCG6R7[WNA01	TMK042 CG6R7[D-W	25	CG C0G	6.7 p	±0.1pF,±0.25pF,±0.5pF	534	200	0.2±0.02	
MLAST042SCG6R8[WNA01	TMK042 CG6R8[D-W	25	CG C0G	6.8 p	±0.1pF,±0.25pF,±0.5pF	536	200	0.2±0.02	
MLAST042SCG6R9[WNA01	TMK042 CG6R9[D-W	25	CG C0G	6.9 p	±0.1pF,±0.25pF,±0.5pF	538	200	0.2±0.02	
MLAST042SCG070[WNA01	TMK042 CG070[D-W	25	CG C0G	7 p	±0.1pF,±0.25pF,±0.5pF	540	200	0.2±0.02	
MLAST042SCG7R1[WNA01	TMK042 CG7R1[D-W	25	CG C0G	7.1 p	±0.1pF,±0.25pF,±0.5pF	542	200	0.2±0.02	
MLAST042SCG7R2[WNA01	TMK042 CG7R2[D-W	25	CG C0G	7.2 p	±0.1pF,±0.25pF,±0.5pF	544	200	0.2±0.02	
MLAST042SCG7R3[WNA01	TMK042 CG7R3[D-W	25	CG C0G	7.3 p	±0.1pF,±0.25pF,±0.5pF	546	200	0.2±0.02	
MLAST042SCG7R4[WNA01	TMK042 CG7R4[D-W	25	CG C0G	7.4 p	±0.1pF,±0.25pF,±0.5pF	548	200	0.2±0.02	
MLAST042SCG7R5[WNA01	TMK042 CG7R5[D-W	25	CG C0G	7.5 p	±0.1pF,±0.25pF,±0.5pF	550	200	0.2±0.02	
MLAST042SCG7R6[WNA01	TMK042 CG7R6[D-W	25	CG C0G	7.6 p	±0.1pF,±0.25pF,±0.5pF	552	200	0.2±0.02	
MLAST042SCG7R7[WNA01	TMK042 CG7R7[D-W	25	CG C0G	7.7 p	±0.1pF,±0.25pF,±0.5pF	554	200	0.2±0.02	
MLAST042SCG7R8[WNA01	TMK042 CG7R8[D-W	25	CG C0G	7.8 p	±0.1pF,±0.25pF,±0.5pF	556	200	0.2±0.02	
MLAST042SCG7R9[WNA01	TMK042 CG7R9[D-W	25	CG C0G	7.9 p	±0.1pF,±0.25pF,±0.5pF	558	200	0.2±0.02	
MLAST042SCG080[WNA01	TMK042 CG080[D-W	25	CG C0G	8 p	±0.1pF,±0.25pF,±0.5pF	560	200	0.2±0.02	
MLAST042SCG8R1[WNA01	TMK042 CG8R1[D-W	25	CG C0G	8.1 p	±0.1pF,±0.25pF,±0.5pF	562	200	0.2±0.02	
MLAST042SCG8R2[WNA01	TMK042 CG8R2[D-W	25	CG C0G	8.2 p	±0.1pF,±0.25pF,±0.5pF	564	200	0.2±0.02	
MLAST042SCG8R3[WNA01	TMK042 CG8R3[D-W	25	CG C0G	8.3 p	±0.1pF,±0.25pF,±0.5pF	566	200	0.2±0.02	
MLAST042SCG8R4[WNA01	TMK042 CG8R4[D-W	25	CG C0G	8.4 p	±0.1pF,±0.25pF,±0.5pF	568	200	0.2±0.02	
MLAST042SCG8R5[WNA01	TMK042 CG8R5[D-W	25	CG C0G	8.5 p	±0.1pF,±0.25pF,±0.5pF	570	200	0.2±0.02	
MLAST042SCG8R6[WNA01	TMK042 CG8R6[D-W	25	CG C0G	8.6 p	±0.1pF,±0.25pF,±0.5pF	572	200	0.2±0.02	
MLAST042SCG8R7[WNA01	TMK042 CG8R7[D-W	25	CG C0G	8.7 p	±0.1pF,±0.25pF,±0.5pF	574	200	0.2±0.02	

▶ This catalog contains the typical specification only due to the limitation of space. When you consider the purchase of our products, please check our specification. For details of each product (characteristics graph, reliability information, precautions for use, and so on), see our Web site (<http://www.ty-top.com/>).

■ PARTS NUMBER

New part number	Old part number (for reference)	Rated voltage [V]	Temperature characteristics		Capacitance [F]	Capacitance tolerance	Q (at 1MHz) (min)	HTLT	Thickness*3 [mm]	Note
								Rated voltage x %		
MLAST042SCG8R8[WNA01	TMK042 CG8R8[D-W	25	CG	C0G	8.8 p	±0.1pF, ±0.25pF, ±0.5pF	576	200	0.2±0.02	
MLAST042SCG8R9[WNA01	TMK042 CG8R9[D-W	25	CG	C0G	8.9 p	±0.1pF, ±0.25pF, ±0.5pF	578	200	0.2±0.02	
MLAST042SCG090[WNA01	TMK042 CG090[D-W	25	CG	C0G	9 p	±0.1pF, ±0.25pF, ±0.5pF	580	200	0.2±0.02	
MLAST042SCG9R1[WNA01	TMK042 CG9R1[D-W	25	CG	C0G	9.1 p	±0.1pF, ±0.25pF, ±0.5pF	582	200	0.2±0.02	
MLAST042SCG9R2[WNA01	TMK042 CG9R2[D-W	25	CG	C0G	9.2 p	±0.1pF, ±0.25pF, ±0.5pF	584	200	0.2±0.02	
MLAST042SCG9R3[WNA01	TMK042 CG9R3[D-W	25	CG	C0G	9.3 p	±0.1pF, ±0.25pF, ±0.5pF	586	200	0.2±0.02	
MLAST042SCG9R4[WNA01	TMK042 CG9R4[D-W	25	CG	C0G	9.4 p	±0.1pF, ±0.25pF, ±0.5pF	588	200	0.2±0.02	
MLAST042SCG9R5[WNA01	TMK042 CG9R5[D-W	25	CG	C0G	9.5 p	±0.1pF, ±0.25pF, ±0.5pF	590	200	0.2±0.02	
MLAST042SCG9R6[WNA01	TMK042 CG9R6[D-W	25	CG	C0G	9.6 p	±0.1pF, ±0.25pF, ±0.5pF	592	200	0.2±0.02	
MLAST042SCG9R7[WNA01	TMK042 CG9R7[D-W	25	CG	C0G	9.7 p	±0.1pF, ±0.25pF, ±0.5pF	594	200	0.2±0.02	
MLAST042SCG9R8[WNA01	TMK042 CG9R8[D-W	25	CG	C0G	9.8 p	±0.1pF, ±0.25pF, ±0.5pF	596	200	0.2±0.02	
MLAST042SCG9R9[WNA01	TMK042 CG9R9[D-W	25	CG	C0G	9.9 p	±0.1pF, ±0.25pF, ±0.5pF	598	200	0.2±0.02	
MLAST042SCG100DWNA01	TMK042 CG100DD-W	25	CG	C0G	10 p	±0.5pF	600	200	0.2±0.02	
MLAST042SCG110JWNA01	TMK042 CG110JD-W	25	CG	C0G	11 p	±5%	620	200	0.2±0.02	
MLAST042SCG120JWNA01	TMK042 CG120JD-W	25	CG	C0G	12 p	±5%	640	200	0.2±0.02	
MLAST042SCG130JWNA01	TMK042 CG130JD-W	25	CG	C0G	13 p	±5%	660	200	0.2±0.02	
MLAST042SCG150JWNA01	TMK042 CG150JD-W	25	CG	C0G	15 p	±5%	700	200	0.2±0.02	
MLAST042SCG160JWNA01	TMK042 CG160JC-W	25	CG	C0G	16 p	±5%	720	200	0.2±0.02	
MLAST042SCG180JWNA01	TMK042 CG180JC-W	25	CG	C0G	18 p	±5%	760	200	0.2±0.02	
MLAST042SCG200JWNA01	TMK042 CG200JC-W	25	CG	C0G	20 p	±5%	800	200	0.2±0.02	
MLAST042SCG220JWNA01	TMK042 CG220JC-W	25	CG	C0G	22 p	±5%	840	200	0.2±0.02	
MLAST042SCG240JWNA01	TMK042 CG240JC-W	25	CG	C0G	24 p	±5%	880	200	0.2±0.02	
MLAST042SCG270JWNA01	TMK042 CG270JC-W	25	CG	C0G	27 p	±5%	940	200	0.2±0.02	
MLAST042SCG300JWNA01	TMK042 CG300JC-W	25	CG	C0G	30 p	±5%	1000	200	0.2±0.02	
MLAST042SCG330JWNA01	TMK042 CG330JC-W	25	CG	C0G	33 p	±5%	1000	200	0.2±0.02	
MLAST042SCG360JWNA01	TMK042 CG360JC-W	25	CG	C0G	36 p	±5%	1000	200	0.2±0.02	
MLAST042SCG390JWNA01	TMK042 CG390JC-W	25	CG	C0G	39 p	±5%	1000	200	0.2±0.02	
MLAST042SCG430JWNA01	TMK042 CG430JC-W	25	CG	C0G	43 p	±5%	1000	200	0.2±0.02	
MLAST042SCG470JWNA01	TMK042 CG470JC-W	25	CG	C0G	47 p	±5%	1000	200	0.2±0.02	
MLAST042SCG510JWNA01	TMK042 CG510JC-W	25	CG	C0G	51 p	±5%	1000	200	0.2±0.02	
MLAST042SCG560JWNA01	TMK042 CG560JC-W	25	CG	C0G	56 p	±5%	1000	200	0.2±0.02	
MLAST042SCG620JWNA01	TMK042 CG620JC-W	25	CG	C0G	62 p	±5%	1000	200	0.2±0.02	
MLAST042SCG680JWNA01	TMK042 CG680JC-W	25	CG	C0G	68 p	±5%	1000	200	0.2±0.02	
MLAST042SCG750JWNA01	TMK042 CG750JC-W	25	CG	C0G	75 p	±5%	1000	200	0.2±0.02	
MLAST042SCG820JWNA01	TMK042 CG820JC-W	25	CG	C0G	82 p	±5%	1000	200	0.2±0.02	
MLAST042SCG910JWNA01	TMK042 CG910JC-W	25	CG	C0G	91 p	±5%	1000	200	0.2±0.02	
MLAST042SCG101JWNA01	TMK042 CG101JC-W	25	CG	C0G	100 p	±5%	1000	200	0.2±0.02	

【Temperature Characteristic CG : CG/C0G (-55~+125°C)】 0.2mm thickness

New part number	Old part number (for reference)	Rated voltage [V]	Temperature characteristics		Capacitance [F]	Capacitance tolerance	Q (at 1MHz) (min)	HTLT	Thickness*3 [mm]	Note
								Rated voltage x %		
MLASE042SCG0R4[WNA01	EMK042 CG0R4[D-W	16	CG	C0G	0.4 p	±0.05pF, ±0.1pF, ±0.25pF	408	200	0.2±0.02	
MLASE042SCG0R5[WNA01	EMK042 CG0R5[D-W	16	CG	C0G	0.5 p	±0.05pF, ±0.1pF, ±0.25pF	410	200	0.2±0.02	
MLASE042SCG0R6[WNA01	EMK042 CG0R6[D-W	16	CG	C0G	0.6 p	±0.05pF, ±0.1pF, ±0.25pF	412	200	0.2±0.02	
MLASE042SCG0R7[WNA01	EMK042 CG0R7[D-W	16	CG	C0G	0.7 p	±0.05pF, ±0.1pF, ±0.25pF	414	200	0.2±0.02	
MLASE042SCG0R75[WNA01	EMK042 CG0R75[D-W	16	CG	C0G	0.75 p	±0.05pF, ±0.1pF, ±0.25pF	415	200	0.2±0.02	
MLASE042SCG0R8[WNA01	EMK042 CG0R8[D-W	16	CG	C0G	0.8 p	±0.05pF, ±0.1pF, ±0.25pF	416	200	0.2±0.02	
MLASE042SCG0R9[WNA01	EMK042 CG0R9[D-W	16	CG	C0G	0.9 p	±0.05pF, ±0.1pF, ±0.25pF	418	200	0.2±0.02	
MLASE042SCG010[WNA01	EMK042 CG010[D-W	16	CG	C0G	1 p	±0.05pF, ±0.1pF, ±0.25pF	420	200	0.2±0.02	
MLASE042SCG1R1[WNA01	EMK042 CG1R1[D-W	16	CG	C0G	1.1 p	±0.05pF, ±0.1pF, ±0.25pF	422	200	0.2±0.02	
MLASE042SCG1R2[WNA01	EMK042 CG1R2[D-W	16	CG	C0G	1.2 p	±0.05pF, ±0.1pF, ±0.25pF	424	200	0.2±0.02	
MLASE042SCG1R3[WNA01	EMK042 CG1R3[D-W	16	CG	C0G	1.3 p	±0.05pF, ±0.1pF, ±0.25pF	426	200	0.2±0.02	
MLASE042SCG1R4[WNA01	EMK042 CG1R4[D-W	16	CG	C0G	1.4 p	±0.05pF, ±0.1pF, ±0.25pF	428	200	0.2±0.02	
MLASE042SCG1R5[WNA01	EMK042 CG1R5[D-W	16	CG	C0G	1.5 p	±0.05pF, ±0.1pF, ±0.25pF	430	200	0.2±0.02	
MLASE042SCG1R6[WNA01	EMK042 CG1R6[D-W	16	CG	C0G	1.6 p	±0.05pF, ±0.1pF, ±0.25pF	432	200	0.2±0.02	
MLASE042SCG1R7[WNA01	EMK042 CG1R7[D-W	16	CG	C0G	1.7 p	±0.05pF, ±0.1pF, ±0.25pF	434	200	0.2±0.02	
MLASE042SCG1R8[WNA01	EMK042 CG1R8[D-W	16	CG	C0G	1.8 p	±0.05pF, ±0.1pF, ±0.25pF	436	200	0.2±0.02	
MLASE042SCG1R9[WNA01	EMK042 CG1R9[D-W	16	CG	C0G	1.9 p	±0.05pF, ±0.1pF, ±0.25pF	438	200	0.2±0.02	
MLASE042SCG020[WNA01	EMK042 CG020[D-W	16	CG	C0G	2 p	±0.05pF, ±0.1pF, ±0.25pF	440	200	0.2±0.02	
MLASE042SCG2R1[WNA01	EMK042 CG2R1[D-W	16	CG	C0G	2.1 p	±0.05pF, ±0.1pF, ±0.25pF	442	200	0.2±0.02	
MLASE042SCG2R2[WNA01	EMK042 CG2R2[D-W	16	CG	C0G	2.2 p	±0.05pF, ±0.1pF, ±0.25pF	444	200	0.2±0.02	
MLASE042SCG2R3[WNA01	EMK042 CG2R3[D-W	16	CG	C0G	2.3 p	±0.05pF, ±0.1pF, ±0.25pF	446	200	0.2±0.02	
MLASE042SCG2R4[WNA01	EMK042 CG2R4[D-W	16	CG	C0G	2.4 p	±0.05pF, ±0.1pF, ±0.25pF	448	200	0.2±0.02	
MLASE042SCG2R5[WNA01	EMK042 CG2R5[D-W	16	CG	C0G	2.5 p	±0.05pF, ±0.1pF, ±0.25pF	450	200	0.2±0.02	
MLASE042SCG2R6[WNA01	EMK042 CG2R6[D-W	16	CG	C0G	2.6 p	±0.05pF, ±0.1pF, ±0.25pF	452	200	0.2±0.02	
MLASE042SCG2R7[WNA01	EMK042 CG2R7[D-W	16	CG	C0G	2.7 p	±0.05pF, ±0.1pF, ±0.25pF	454	200	0.2±0.02	
MLASE042SCG2R8[WNA01	EMK042 CG2R8[D-W	16	CG	C0G	2.8 p	±0.05pF, ±0.1pF, ±0.25pF	456	200	0.2±0.02	
MLASE042SCG2R9[WNA01	EMK042 CG2R9[D-W	16	CG	C0G	2.9 p	±0.05pF, ±0.1pF, ±0.25pF	458	200	0.2±0.02	
MLASE042SCG030[WNA01	EMK042 CG030[D-W	16	CG	C0G	3 p	±0.05pF, ±0.1pF, ±0.25pF	460	200	0.2±0.02	
MLASE042SCG3R1[WNA01	EMK042 CG3R1[D-W	16	CG	C0G	3.1 p	±0.1pF, ±0.25pF	462	200	0.2±0.02	
MLASE042SCG3R2[WNA01	EMK042 CG3R2[D-W	16	CG	C0G	3.2 p	±0.1pF, ±0.25pF	464	200	0.2±0.02	
MLASE042SCG3R3[WNA01	EMK042 CG3R3[D-W	16	CG	C0G	3.3 p	±0.1pF, ±0.25pF	466	200	0.2±0.02	
MLASE042SCG3R4[WNA01	EMK042 CG3R4[D-W	16	CG	C0G	3.4 p	±0.1pF, ±0.25pF	468	200	0.2±0.02	
MLASE042SCG3R5[WNA01	EMK042 CG3R5[D-W	16	CG	C0G	3.5 p	±0.1pF, ±0.25pF	470	200	0.2±0.02	
MLASE042SCG3R6[WNA01	EMK042 CG3R6[D-W	16	CG	C0G	3.6 p	±0.1pF, ±0.25pF	472	200	0.2±0.02	
MLASE042SCG3R7[WNA01	EMK042 CG3R7[D-W	16	CG	C0G	3.7 p	±0.1pF, ±0.25pF	474	200	0.2±0.02	
MLASE042SCG3R8[WNA01	EMK042 CG3R8[D-W	16	CG	C0G	3.8 p	±0.1pF, ±0.25pF	476	200	0.2±0.02	
MLASE042SCG3R9[WNA01	EMK042 CG3R9[D-W	16	CG	C0G	3.9 p	±0.1pF, ±0.25pF	478	200	0.2±0.02	
MLASE042SCG040[WNA01	EMK042 CG040[D-W	16	CG	C0G	4 p	±0.1pF, ±0.25pF	480	200	0.2±0.02	
MLASE042SCG4R1[WNA01	EMK042 CG4R1[D-W	16	CG	C0G	4.1 p	±0.1pF, ±0.25pF	482	200	0.2±0.02	
MLASE042SCG4R2[WNA01	EMK042 CG4R2[D-W	16	CG	C0G	4.2 p	±0.1pF, ±0.25pF	484	200	0.2±0.02	
MLASE042SCG4R3[WNA01	EMK042 CG4R3[D-W	16	CG	C0G	4.3 p	±0.1pF, ±0.25pF	486	200	0.2±0.02	
MLASE042SCG4R4[WNA01	EMK042 CG4R4[D-W	16	CG	C0G	4.4 p	±0.1pF, ±0.25pF	488	200	0.2±0.02	
MLASE042SCG4R5[WNA01	EMK042 CG4R5[D-W	16	CG	C0G	4.5 p	±0.1pF, ±0.25pF	490	200	0.2±0.02	
MLASE042SCG4R6[WNA01	EMK042 CG4R6[D-W	16	CG	C0G	4.6 p	±0.1pF, ±0.25pF	492	200	0.2±0.02	

▶ This catalog contains the typical specification only due to the limitation of space. When you consider the purchase of our products, please check our specification.  
For details of each product (characteristics graph, reliability information, precautions for use, and so on), see our Web site (<http://www.ty-top.com/>).

■ PARTS NUMBER

New part number	Old part number (for reference)	Rated voltage [V]	Temperature characteristics		Capacitance [F]	Capacitance tolerance	Q (at 1MHz) (min)	HTLT	Thickness*3 [mm]	Note
								Rated voltage x %		
MLASE042SCG4R7[WNA01	EMK042 CG4R7[D-W	16	CG	C0G	4.7 p	±0.1pF, ±0.25pF	494	200	0.2±0.02	
MLASE042SCG4R8[WNA01	EMK042 CG4R8[D-W	16	CG	C0G	4.8 p	±0.1pF, ±0.25pF	496	200	0.2±0.02	
MLASE042SCG4R9[WNA01	EMK042 CG4R9[D-W	16	CG	C0G	4.9 p	±0.1pF, ±0.25pF	498	200	0.2±0.02	
MLASE042SCG050[WNA01	EMK042 CG050[D-W	16	CG	C0G	5 p	±0.1pF, ±0.25pF	500	200	0.2±0.02	
MLASE042SCG5R1[WNA01	EMK042 CG5R1[D-W	16	CG	C0G	5.1 p	±0.1pF, ±0.25pF, ±0.5pF	502	200	0.2±0.02	
MLASE042SCG5R2[WNA01	EMK042 CG5R2[D-W	16	CG	C0G	5.2 p	±0.1pF, ±0.25pF, ±0.5pF	504	200	0.2±0.02	
MLASE042SCG5R3[WNA01	EMK042 CG5R3[D-W	16	CG	C0G	5.3 p	±0.1pF, ±0.25pF, ±0.5pF	506	200	0.2±0.02	
MLASE042SCG5R4[WNA01	EMK042 CG5R4[D-W	16	CG	C0G	5.4 p	±0.1pF, ±0.25pF, ±0.5pF	508	200	0.2±0.02	
MLASE042SCG5R5[WNA01	EMK042 CG5R5[D-W	16	CG	C0G	5.5 p	±0.1pF, ±0.25pF, ±0.5pF	510	200	0.2±0.02	
MLASE042SCG5R6[WNA01	EMK042 CG5R6[D-W	16	CG	C0G	5.6 p	±0.1pF, ±0.25pF, ±0.5pF	512	200	0.2±0.02	
MLASE042SCG5R7[WNA01	EMK042 CG5R7[D-W	16	CG	C0G	5.7 p	±0.1pF, ±0.25pF, ±0.5pF	514	200	0.2±0.02	
MLASE042SCG5R8[WNA01	EMK042 CG5R8[D-W	16	CG	C0G	5.8 p	±0.1pF, ±0.25pF, ±0.5pF	516	200	0.2±0.02	
MLASE042SCG5R9[WNA01	EMK042 CG5R9[D-W	16	CG	C0G	5.9 p	±0.1pF, ±0.25pF, ±0.5pF	518	200	0.2±0.02	
MLASE042SCG060[WNA01	EMK042 CG060[D-W	16	CG	C0G	6 p	±0.1pF, ±0.25pF, ±0.5pF	520	200	0.2±0.02	
MLASE042SCG6R1[WNA01	EMK042 CG6R1[D-W	16	CG	C0G	6.1 p	±0.1pF, ±0.25pF, ±0.5pF	522	200	0.2±0.02	
MLASE042SCG6R2[WNA01	EMK042 CG6R2[D-W	16	CG	C0G	6.2 p	±0.1pF, ±0.25pF, ±0.5pF	524	200	0.2±0.02	
MLASE042SCG6R3[WNA01	EMK042 CG6R3[D-W	16	CG	C0G	6.3 p	±0.1pF, ±0.25pF, ±0.5pF	526	200	0.2±0.02	
MLASE042SCG6R4[WNA01	EMK042 CG6R4[D-W	16	CG	C0G	6.4 p	±0.1pF, ±0.25pF, ±0.5pF	528	200	0.2±0.02	
MLASE042SCG6R5[WNA01	EMK042 CG6R5[D-W	16	CG	C0G	6.5 p	±0.1pF, ±0.25pF, ±0.5pF	530	200	0.2±0.02	
MLASE042SCG6R6[WNA01	EMK042 CG6R6[D-W	16	CG	C0G	6.6 p	±0.1pF, ±0.25pF, ±0.5pF	532	200	0.2±0.02	
MLASE042SCG6R7[WNA01	EMK042 CG6R7[D-W	16	CG	C0G	6.7 p	±0.1pF, ±0.25pF, ±0.5pF	534	200	0.2±0.02	
MLASE042SCG6R8[WNA01	EMK042 CG6R8[D-W	16	CG	C0G	6.8 p	±0.1pF, ±0.25pF, ±0.5pF	536	200	0.2±0.02	
MLASE042SCG6R9[WNA01	EMK042 CG6R9[D-W	16	CG	C0G	6.9 p	±0.1pF, ±0.25pF, ±0.5pF	538	200	0.2±0.02	
MLASE042SCG070[WNA01	EMK042 CG070[D-W	16	CG	C0G	7 p	±0.1pF, ±0.25pF, ±0.5pF	540	200	0.2±0.02	
MLASE042SCG7R1[WNA01	EMK042 CG7R1[D-W	16	CG	C0G	7.1 p	±0.1pF, ±0.25pF, ±0.5pF	542	200	0.2±0.02	
MLASE042SCG7R2[WNA01	EMK042 CG7R2[D-W	16	CG	C0G	7.2 p	±0.1pF, ±0.25pF, ±0.5pF	544	200	0.2±0.02	
MLASE042SCG7R3[WNA01	EMK042 CG7R3[D-W	16	CG	C0G	7.3 p	±0.1pF, ±0.25pF, ±0.5pF	546	200	0.2±0.02	
MLASE042SCG7R4[WNA01	EMK042 CG7R4[D-W	16	CG	C0G	7.4 p	±0.1pF, ±0.25pF, ±0.5pF	548	200	0.2±0.02	
MLASE042SCG7R5[WNA01	EMK042 CG7R5[D-W	16	CG	C0G	7.5 p	±0.1pF, ±0.25pF, ±0.5pF	550	200	0.2±0.02	
MLASE042SCG7R6[WNA01	EMK042 CG7R6[D-W	16	CG	C0G	7.6 p	±0.1pF, ±0.25pF, ±0.5pF	552	200	0.2±0.02	
MLASE042SCG7R7[WNA01	EMK042 CG7R7[D-W	16	CG	C0G	7.7 p	±0.1pF, ±0.25pF, ±0.5pF	554	200	0.2±0.02	
MLASE042SCG7R8[WNA01	EMK042 CG7R8[D-W	16	CG	C0G	7.8 p	±0.1pF, ±0.25pF, ±0.5pF	556	200	0.2±0.02	
MLASE042SCG7R9[WNA01	EMK042 CG7R9[D-W	16	CG	C0G	7.9 p	±0.1pF, ±0.25pF, ±0.5pF	558	200	0.2±0.02	
MLASE042SCG080[WNA01	EMK042 CG080[D-W	16	CG	C0G	8 p	±0.1pF, ±0.25pF, ±0.5pF	560	200	0.2±0.02	
MLASE042SCG8R1[WNA01	EMK042 CG8R1[D-W	16	CG	C0G	8.1 p	±0.1pF, ±0.25pF, ±0.5pF	562	200	0.2±0.02	
MLASE042SCG8R2[WNA01	EMK042 CG8R2[D-W	16	CG	C0G	8.2 p	±0.1pF, ±0.25pF, ±0.5pF	564	200	0.2±0.02	
MLASE042SCG8R3[WNA01	EMK042 CG8R3[D-W	16	CG	C0G	8.3 p	±0.1pF, ±0.25pF, ±0.5pF	566	200	0.2±0.02	
MLASE042SCG8R4[WNA01	EMK042 CG8R4[D-W	16	CG	C0G	8.4 p	±0.1pF, ±0.25pF, ±0.5pF	568	200	0.2±0.02	
MLASE042SCG8R5[WNA01	EMK042 CG8R5[D-W	16	CG	C0G	8.5 p	±0.1pF, ±0.25pF, ±0.5pF	570	200	0.2±0.02	
MLASE042SCG8R6[WNA01	EMK042 CG8R6[D-W	16	CG	C0G	8.6 p	±0.1pF, ±0.25pF, ±0.5pF	572	200	0.2±0.02	
MLASE042SCG8R7[WNA01	EMK042 CG8R7[D-W	16	CG	C0G	8.7 p	±0.1pF, ±0.25pF, ±0.5pF	574	200	0.2±0.02	
MLASE042SCG8R8[WNA01	EMK042 CG8R8[D-W	16	CG	C0G	8.8 p	±0.1pF, ±0.25pF, ±0.5pF	576	200	0.2±0.02	
MLASE042SCG8R9[WNA01	EMK042 CG8R9[D-W	16	CG	C0G	8.9 p	±0.1pF, ±0.25pF, ±0.5pF	578	200	0.2±0.02	
MLASE042SCG090[WNA01	EMK042 CG090[D-W	16	CG	C0G	9 p	±0.1pF, ±0.25pF, ±0.5pF	580	200	0.2±0.02	
MLASE042SCG9R1[WNA01	EMK042 CG9R1[D-W	16	CG	C0G	9.1 p	±0.1pF, ±0.25pF, ±0.5pF	582	200	0.2±0.02	
MLASE042SCG9R2[WNA01	EMK042 CG9R2[D-W	16	CG	C0G	9.2 p	±0.1pF, ±0.25pF, ±0.5pF	584	200	0.2±0.02	
MLASE042SCG9R3[WNA01	EMK042 CG9R3[D-W	16	CG	C0G	9.3 p	±0.1pF, ±0.25pF, ±0.5pF	586	200	0.2±0.02	
MLASE042SCG9R4[WNA01	EMK042 CG9R4[D-W	16	CG	C0G	9.4 p	±0.1pF, ±0.25pF, ±0.5pF	588	200	0.2±0.02	
MLASE042SCG9R5[WNA01	EMK042 CG9R5[D-W	16	CG	C0G	9.5 p	±0.1pF, ±0.25pF, ±0.5pF	590	200	0.2±0.02	
MLASE042SCG9R6[WNA01	EMK042 CG9R6[D-W	16	CG	C0G	9.6 p	±0.1pF, ±0.25pF, ±0.5pF	592	200	0.2±0.02	
MLASE042SCG9R7[WNA01	EMK042 CG9R7[D-W	16	CG	C0G	9.7 p	±0.1pF, ±0.25pF, ±0.5pF	594	200	0.2±0.02	
MLASE042SCG9R8[WNA01	EMK042 CG9R8[D-W	16	CG	C0G	9.8 p	±0.1pF, ±0.25pF, ±0.5pF	596	200	0.2±0.02	
MLASE042SCG9R9[WNA01	EMK042 CG9R9[D-W	16	CG	C0G	9.9 p	±0.1pF, ±0.25pF, ±0.5pF	598	200	0.2±0.02	
MLASE042SCG100D[WNA01	EMK042 CG100D[W	16	CG	C0G	10 p	±0.5pF	600	200	0.2±0.02	
MLASE042SCG110J[WNA01	EMK042 CG110J[W	16	CG	C0G	11 p	±5%	620	200	0.2±0.02	
MLASE042SCG120J[WNA01	EMK042 CG120J[W	16	CG	C0G	12 p	±5%	640	200	0.2±0.02	
MLASE042SCG130J[WNA01	EMK042 CG130J[W	16	CG	C0G	13 p	±5%	660	200	0.2±0.02	
MLASE042SCG150J[WNA01	EMK042 CG150J[W	16	CG	C0G	15 p	±5%	700	200	0.2±0.02	
MLASE042SCG160J[WNA01	EMK042 CG160J[W	16	CG	C0G	16 p	±5%	720	200	0.2±0.02	
MLASE042SCG180J[WNA01	EMK042 CG180J[W	16	CG	C0G	18 p	±5%	760	200	0.2±0.02	
MLASE042SCG200J[WNA01	EMK042 CG200J[W	16	CG	C0G	20 p	±5%	800	200	0.2±0.02	
MLASE042SCG220J[WNA01	EMK042 CG220J[W	16	CG	C0G	22 p	±5%	840	200	0.2±0.02	
MLASE042SCG240J[WNA01	EMK042 CG240J[W	16	CG	C0G	24 p	±5%	880	200	0.2±0.02	
MLASE042SCG270J[WNA01	EMK042 CG270J[W	16	CG	C0G	27 p	±5%	940	200	0.2±0.02	
MLASE042SCG300J[WNA01	EMK042 CG300J[W	16	CG	C0G	30 p	±5%	1000	200	0.2±0.02	
MLASE042SCG330J[WNA01	EMK042 CG330J[W	16	CG	C0G	33 p	±5%	1000	200	0.2±0.02	
MLASE042SCG360J[WNA01	EMK042 CG360J[W	16	CG	C0G	36 p	±5%	1000	200	0.2±0.02	
MLASE042SCG390J[WNA01	EMK042 CG390J[W	16	CG	C0G	39 p	±5%	1000	200	0.2±0.02	
MLASE042SCG430J[WNA01	EMK042 CG430J[W	16	CG	C0G	43 p	±5%	1000	200	0.2±0.02	
MLASE042SCG470J[WNA01	EMK042 CG470J[W	16	CG	C0G	47 p	±5%	1000	200	0.2±0.02	
MLASE042SCG510J[WNA01	EMK042 CG510J[W	16	CG	C0G	51 p	±5%	1000	200	0.2±0.02	
MLASE042SCG560J[WNA01	EMK042 CG560J[W	16	CG	C0G	56 p	±5%	1000	200	0.2±0.02	
MLASE042SCG620J[WNA01	EMK042 CG620J[W	16	CG	C0G	62 p	±5%	1000	200	0.2±0.02	
MLASE042SCG680J[WNA01	EMK042 CG680J[W	16	CG	C0G	68 p	±5%	1000	200	0.2±0.02	
MLASE042SCG750J[WNA01	EMK042 CG750J[W	16	CG	C0G	75 p	±5%	1000	200	0.2±0.02	
MLASE042SCG820J[WNA01	EMK042 CG820J[W	16	CG	C0G	82 p	±5%	1000	200	0.2±0.02	
MLASE042SCG910J[WNA01	EMK042 CG910J[W	16	CG	C0G	91 p	±5%	1000	200	0.2±0.02	
MLASE042SCG101J[WNA01	EMK042 CG101J[W	16	CG	C0G	100 p	±5%	1000	200	0.2±0.02	
MLASE042SCG221J[WNA01	EMK042 CG221J[W	16	CG	C0G	220 p	±5%	1000	200	0.2±0.02	
MLASE042SCG241J[WNA01	EMK042 CG241J[W	16	CG	C0G	240 p	±5%	1000	200	0.2±0.02	
MLASE042SCG271J[WNA01	EMK042 CG271J[W	16	CG	C0G	270 p	±5%	1000	200	0.2±0.02	
MLASE042SCG331J[WNA01	EMK042 CG331J[W	16	CG	C0G	330 p	±5%	1000	200	0.2±0.02	

▶ This catalog contains the typical specification only due to the limitation of space. When you consider the purchase of our products, please check our specification.  
For details of each product (characteristics graph, reliability information, precautions for use, and so on), see our Web site (<http://www.ty-top.com/>).

## PARTS NUMBER

## 0603TYPE

【Temperature Characteristic CH : CH/C0H(-55~+125°C)】 0.3mm thickness

New part number	Old part number (for reference)	Rated voltage [V]	Temperature characteristics		Capacitance [F]	Capacitance tolerance	Q (at 1MHz) (min)	HTLT	Thickness*3 [mm]	Note
								Rated voltage x %		
MLASU063SCH200JFNA01	UMK063 CH200JT-F	50	CH	C0H	20 p	±5%	800	200	0.3±0.03	
MLASU063SCH220JFNA01	UMK063 CH220JT-F	50	CH	C0H	22 p	±5%	840	200	0.3±0.03	
MLASU063SCH240JFNA01	UMK063 CH240JT-F	50	CH	C0H	24 p	±5%	880	200	0.3±0.03	
MLASU063SCH270JFNA01	UMK063 CH270JT-F	50	CH	C0H	27 p	±5%	940	200	0.3±0.03	
MLASU063SCH300JFNA01	UMK063 CH300JT-F	50	CH	C0H	30 p	±5%	1000	200	0.3±0.03	
MLASU063SCH330JFNA01	UMK063 CH330JT-F	50	CH	C0H	33 p	±5%	1000	200	0.3±0.03	
MLASU063SCH360JFNA01	UMK063 CH360JT-F	50	CH	C0H	36 p	±5%	1000	200	0.3±0.03	
MLASU063SCH390JFNA01	UMK063 CH390JT-F	50	CH	C0H	39 p	±5%	1000	200	0.3±0.03	
MLASU063SCH430JFNA01	UMK063 CH430JT-F	50	CH	C0H	43 p	±5%	1000	200	0.3±0.03	
MLASU063SCH470JFNA01	UMK063 CH470JT-F	50	CH	C0H	47 p	±5%	1000	200	0.3±0.03	
MLASU063SCH510JFNA01	UMK063 CH510JT-F	50	CH	C0H	51 p	±5%	1000	200	0.3±0.03	
MLASU063SCH560JFNA01	UMK063 CH560JT-F	50	CH	C0H	56 p	±5%	1000	200	0.3±0.03	
MLASU063SCH620JFNA01	UMK063 CH620JT-F	50	CH	C0H	62 p	±5%	1000	200	0.3±0.03	
MLASU063SCH680JFNA01	UMK063 CH680JT-F	50	CH	C0H	68 p	±5%	1000	200	0.3±0.03	
MLASU063SCH750JFNA01	UMK063 CH750JT-F	50	CH	C0H	75 p	±5%	1000	200	0.3±0.03	
MLASU063SCH820JFNA01	UMK063 CH820JT-F	50	CH	C0H	82 p	±5%	1000	200	0.3±0.03	
MLASU063SCH910JFNA01	UMK063 CH910JT-F	50	CH	C0H	91 p	±5%	1000	200	0.3±0.03	
MLASU063SCH101JFNA01	UMK063 CH101JT-F	50	CH	C0H	100 p	±5%	1000	200	0.3±0.03	
MLASU063SCH111JFNA01	UMK063 CH111JT-F	50	CH	C0H	110 p	±5%	1000	200	0.3±0.03	
MLASU063SCH121JFNA01	UMK063 CH121JT-F	50	CH	C0H	120 p	±5%	1000	200	0.3±0.03	
MLASU063SCH131JFNA01	UMK063 CH131JT-F	50	CH	C0H	130 p	±5%	1000	200	0.3±0.03	
MLASU063SCH151JFNA01	UMK063 CH151JT-F	50	CH	C0H	150 p	±5%	1000	200	0.3±0.03	
MLASU063SCH181JFNA01	UMK063 CH181JT-F	50	CH	C0H	180 p	±5%	1000	200	0.3±0.03	
MLASU063SCH201JFNA01	UMK063 CH201JT-F	50	CH	C0H	200 p	±5%	1000	200	0.3±0.03	
MLASU063SCH221JFNA01	UMK063 CH221JT-F	50	CH	C0H	220 p	±5%	1000	200	0.3±0.03	
MLAST063SCH241JFNA01	TMK063 CH241JT-F	25	CH	C0H	240 p	±5%	1000	200	0.3±0.03	
MLAST063SCH271JFNA01	TMK063 CH271JT-F	25	CH	C0H	270 p	±5%	1000	200	0.3±0.03	
MLAST063SCH301JFNA01	TMK063 CH301JT-F	25	CH	C0H	300 p	±5%	1000	200	0.3±0.03	
MLAST063SCH331JFNA01	TMK063 CH331JT-F	25	CH	C0H	330 p	±5%	1000	200	0.3±0.03	
MLAST063SCH361JFNA01	TMK063 CH361JT-F	25	CH	C0H	360 p	±5%	1000	200	0.3±0.03	
MLAST063SCH391JFNA01	TMK063 CH391JT-F	25	CH	C0H	390 p	±5%	1000	200	0.3±0.03	
MLAST063SCH431JFNA01	TMK063 CH431JT-F	25	CH	C0H	430 p	±5%	1000	200	0.3±0.03	
MLAST063SCH471JFNA01	TMK063 CH471JT-F	25	CH	C0H	470 p	±5%	1000	200	0.3±0.03	
MLAST063SCH511JFNA01	TMK063 CH511JT-F	25	CH	C0H	510 p	±5%	1000	200	0.3±0.03	
MLAST063SCH561JFNA01	TMK063 CH561JT-F	25	CH	C0H	560 p	±5%	1000	200	0.3±0.03	
MLAST063SCH621JFNA01	TMK063 CH621JT-F	25	CH	C0H	620 p	±5%	1000	200	0.3±0.03	
MLAST063SCH681JFNA01	TMK063 CH681JT-F	25	CH	C0H	680 p	±5%	1000	200	0.3±0.03	
MLAST063SCH751JFNA01	TMK063 CH751JT-F	25	CH	C0H	750 p	±5%	1000	200	0.3±0.03	
MLAST063SCH821JFNA01	TMK063 CH821JT-F	25	CH	C0H	820 p	±5%	1000	200	0.3±0.03	
MLAST063SCH911JFNA01	TMK063 CH911JT-F	25	CH	C0H	910 p	±5%	1000	200	0.3±0.03	
MLAST063SCH102JFNA01	TMK063 CH102JT-F	25	CH	C0H	1000 p	±5%	1000	200	0.3±0.03	

## PARTS NUMBER

【Temperature Characteristic CG : CG/C0G (−55~+125°C)】 0.3mm thickness

New part number	Old part number (for reference)	Rated voltage [V]	Temperature characteristics		Capacitance [F]	Capacitance tolerance	Q (at 1MHz) (min)	HTLT	Thickness*3 [mm]	Note
								Rated voltage x %		
MLASU063SCG200JFNA01	UMK063 CG200JT-F	50	CG	C0G	20 p	±5%	800	200	0.3±0.03	
MLASU063SCG220JFNA01	UMK063 CG220JT-F	50	CG	C0G	22 p	±5%	840	200	0.3±0.03	
MLASU063SCG240JFNA01	UMK063 CG240JT-F	50	CG	C0G	24 p	±5%	880	200	0.3±0.03	
MLASU063SCG270JFNA01	UMK063 CG270JT-F	50	CG	C0G	27 p	±5%	940	200	0.3±0.03	
MLASU063SCG300JFNA01	UMK063 CG300JT-F	50	CG	C0G	30 p	±5%	1000	200	0.3±0.03	
MLASU063SCG330JFNA01	UMK063 CG330JT-F	50	CG	C0G	33 p	±5%	1000	200	0.3±0.03	
MLASU063SCG360JFNA01	UMK063 CG360JT-F	50	CG	C0G	36 p	±5%	1000	200	0.3±0.03	
MLASU063SCG390JFNA01	UMK063 CG390JT-F	50	CG	C0G	39 p	±5%	1000	200	0.3±0.03	
MLASU063SCG430JFNA01	UMK063 CG430JT-F	50	CG	C0G	43 p	±5%	1000	200	0.3±0.03	
MLASU063SCG470JFNA01	UMK063 CG470JT-F	50	CG	C0G	47 p	±5%	1000	200	0.3±0.03	
MLASU063SCG510JFNA01	UMK063 CG510JT-F	50	CG	C0G	51 p	±5%	1000	200	0.3±0.03	
MLASU063SCG560JFNA01	UMK063 CG560JT-F	50	CG	C0G	56 p	±5%	1000	200	0.3±0.03	
MLASU063SCG620JFNA01	UMK063 CG620JT-F	50	CG	C0G	62 p	±5%	1000	200	0.3±0.03	
MLASU063SCG680JFNA01	UMK063 CG680JT-F	50	CG	C0G	68 p	±5%	1000	200	0.3±0.03	
MLASU063SCG750JFNA01	UMK063 CG750JT-F	50	CG	C0G	75 p	±5%	1000	200	0.3±0.03	
MLASU063SCG820JFNA01	UMK063 CG820JT-F	50	CG	C0G	82 p	±5%	1000	200	0.3±0.03	
MLASU063SCG910JFNA01	UMK063 CG910JT-F	50	CG	C0G	91 p	±5%	1000	200	0.3±0.03	
MLASU063SCG101JFNA01	UMK063 CG101JT-F	50	CG	C0G	100 p	±5%	1000	200	0.3±0.03	
MLASU063SCG111JFNA01	UMK063 CG111JT-F	50	CG	C0G	110 p	±5%	1000	200	0.3±0.03	
MLASU063SCG121JFNA01	UMK063 CG121JT-F	50	CG	C0G	120 p	±5%	1000	200	0.3±0.03	
MLASU063SCG131JFNA01	UMK063 CG131JT-F	50	CG	C0G	130 p	±5%	1000	200	0.3±0.03	
MLASU063SCG151JFNA01	UMK063 CG151JT-F	50	CG	C0G	150 p	±5%	1000	200	0.3±0.03	
MLASU063SCG181JFNA01	UMK063 CG181JT-F	50	CG	C0G	180 p	±5%	1000	200	0.3±0.03	
MLASU063SCG201JFNA01	UMK063 CG201JT-F	50	CG	C0G	200 p	±5%	1000	200	0.3±0.03	
MLASU063SCG221JFNA01	UMK063 CG221JT-F	50	CG	C0G	220 p	±5%	1000	200	0.3±0.03	
MLAST063SCG241JFNA01	TMK063 CG241JT-F	25	CG	C0G	240 p	±5%	1000	200	0.3±0.03	
MLAST063SCG271JFNA01	TMK063 CG271JT-F	25	CG	C0G	270 p	±5%	1000	200	0.3±0.03	
MLAST063SCG301JFNA01	TMK063 CG301JT-F	25	CG	C0G	300 p	±5%	1000	200	0.3±0.03	
MLAST063SCG331JFNA01	TMK063 CG331JT-F	25	CG	C0G	330 p	±5%	1000	200	0.3±0.03	
MLAST063SCG361JFNA01	TMK063 CG361JT-F	25	CG	C0G	360 p	±5%	1000	200	0.3±0.03	
MLAST063SCG391JFNA01	TMK063 CG391JT-F	25	CG	C0G	390 p	±5%	1000	200	0.3±0.03	
MLAST063SCG431JFNA01	TMK063 CG431JT-F	25	CG	C0G	430 p	±5%	1000	200	0.3±0.03	
MLAST063SCG471JFNA01	TMK063 CG471JT-F	25	CG	C0G	470 p	±5%	1000	200	0.3±0.03	
MLAST063SCG511JFNA01	TMK063 CG511JT-F	25	CG	C0G	510 p	±5%	1000	200	0.3±0.03	
MLAST063SCG561JFNA01	TMK063 CG561JT-F	25	CG	C0G	560 p	±5%	1000	200	0.3±0.03	
MLAST063SCG621JFNA01	TMK063 CG621JT-F	25	CG	C0G	620 p	±5%	1000	200	0.3±0.03	
MLAST063SCG681JFNA01	TMK063 CG681JT-F	25	CG	C0G	680 p	±5%	1000	200	0.3±0.03	
MLAST063SCG751JFNA01	TMK063 CG751JT-F	25	CG	C0G	750 p	±5%	1000	200	0.3±0.03	
MLAST063SCG821JFNA01	TMK063 CG821JT-F	25	CG	C0G	820 p	±5%	1000	200	0.3±0.03	
MLAST063SCG911JFNA01	TMK063 CG911JT-F	25	CG	C0G	910 p	±5%	1000	200	0.3±0.03	
MLAST063SCG102JFNA01	TMK063 CG102JT-F	25	CG	C0G	1000 p	±5%	1000	200	0.3±0.03	



## PARTS NUMBER

## Low distortion design/Audible/Good bias Multilayer Ceramic Capacitors (CFCAP) for Medical Devices classified as GHTF Classes A or B (Japan Classes I or II)

## 1005TYPE

【Temperature Characteristic SD : Standard(-55~+125°C)】0.5mm thickness

New part number	Old part number (for reference)	Rated voltage [V]	Temperature characteristics	Capacitance [F]	Capacitance tolerance [%]	tan δ [%]	HTLT	Thickness*3 [mm]	Note
							Rated voltage x %		
MLAYU105SSD391KFNA01	UMK105 SD391KV-F	50	Standard Type	390 p	±10	0.1	200	0.5±0.05	
MLAYU105SSD471KFNA01	UMK105 SD471KV-F	50	Standard Type	470 p	±10	0.1	200	0.5±0.05	
MLAYU105SSD561KFNA01	UMK105 SD561KV-F	50	Standard Type	560 p	±10	0.1	200	0.5±0.05	
MLAYT105SSD681KFNA01	TMK105 SD681KV-F	25	Standard Type	680 p	±10	0.1	200	0.5±0.05	
MLAYT105SSD821KFNA01	TMK105 SD821KV-F	25	Standard Type	820 p	±10	0.1	200	0.5±0.05	
MLAYT105SSD102KFNA01	TMK105 SD102KV-F	25	Standard Type	1000 p	±10	0.1	200	0.5±0.05	
MLAYT105SSD122KFNA01	TMK105 SD122KV-F	25	Standard Type	1200 p	±10	0.1	200	0.5±0.05	
MLAYE105SSD152KFNA01	EMK105 SD152KV-F	16	Standard Type	1500 p	±10	0.1	200	0.5±0.05	
MLAYE105SSD182KFNA01	EMK105 SD182KV-F	16	Standard Type	1800 p	±10	0.1	200	0.5±0.05	
MLAYE105SSD222KFNA01	EMK105 SD222KV-F	16	Standard Type	2200 p	±10	0.1	200	0.5±0.05	
MLAYE105SSD272KFNA01	EMK105 SD272KV-F	16	Standard Type	2700 p	±10	0.1	200	0.5±0.05	
MLAYL105SSD332KFNA01	LMK105 SD332KV-F	10	Standard Type	3300 p	±10	0.1	200	0.5±0.05	
MLAYL105SSD392KFNA01	LMK105 SD392KV-F	10	Standard Type	3900 p	±10	0.1	200	0.5±0.05	
MLAYL105SSD472KFNA01	LMK105 SD472KV-F	10	Standard Type	4700 p	±10	0.1	200	0.5±0.05	

【Temperature Characteristic SD : Standard(-55~+125°C)】0.3mm thickness

New part number	Old part number (for reference)	Rated voltage [V]	Temperature characteristics	Capacitance [F]	Capacitance tolerance [%]	tan δ [%]	HTLT	Thickness*3 [mm]	Note
							Rated voltage x %		
MLAYL1L3YSD152KFNA01	LMK105 SD152KP-F	10	Standard Type	1500 p	±10	0.1	200	0.3±0.03	
MLAYJ1L3YSD272KFNA01	JMK105 SD272KP-F	6.3	Standard Type	2700 p	±10	0.1	200	0.3±0.03	

## 1608TYPE

【Temperature Characteristic SD : Standard(-55~+125°C)】0.8mm thickness

New part number	Old part number (for reference)	Rated voltage [V]	Temperature characteristics	Capacitance [F]	Capacitance tolerance [%]	tan δ [%]	HTLT	Thickness*3 [mm]	Note
							Rated voltage x %		
MLAYU168SSD102KTNA01	UMK107 SD102KA-T	50	Standard Type	1000 p	±10	0.1	200	0.8±0.10	
MLAYU168SSD122KTNA01	UMK107 SD122KA-T	50	Standard Type	1200 p	±10	0.1	200	0.8±0.10	
MLAYU168SSD152KTNA01	UMK107 SD152KA-T	50	Standard Type	1500 p	±10	0.1	200	0.8±0.10	
MLAYU168SSD182KTNA01	UMK107 SD182KA-T	50	Standard Type	1800 p	±10	0.1	200	0.8±0.10	
MLAYU168SSD222KTNA01	UMK107 SD222KA-T	50	Standard Type	2200 p	±10	0.1	200	0.8±0.10	
MLAYU168SSD272KTNA01	UMK107 SD272KA-T	50	Standard Type	2700 p	±10	0.1	200	0.8±0.10	
MLAYU168SSD332KTNA01	UMK107 SD332KA-T	50	Standard Type	3300 p	±10	0.1	200	0.8±0.10	
MLAYT168SSD392KTNA01	TMK107 SD392KA-T	25	Standard Type	3900 p	±10	0.1	200	0.8±0.10	
MLAYT168SSD472KTNA01	TMK107 SD472KA-T	25	Standard Type	4700 p	±10	0.1	200	0.8±0.10	
MLAYE168SSD562KTNA01	EMK107 SD562KA-T	16	Standard Type	5600 p	±10	0.1	200	0.8±0.10	
MLAYE168SSD682KTNA01	EMK107 SD682KA-T	16	Standard Type	6800 p	±10	0.1	200	0.8±0.10	
MLAYE168SSD822KTNA01	EMK107 SD822KA-T	16	Standard Type	8200 p	±10	0.1	200	0.8±0.10	
MLAYE168SSD103KTNA01	EMK107 SD103KA-T	16	Standard Type	0.01 μ	±10	0.1	200	0.8±0.10	
MLAYL168SSD123KTNA01	LMK107 SD123KA-T	10	Standard Type	0.012 μ	±10	0.1	200	0.8±0.10	
MLAYL168SSD153KTNA01	LMK107 SD153KA-T	10	Standard Type	0.015 μ	±10	0.1	200	0.8±0.10	
MLAYL168SSD183KTNA01	LMK107 SD183KA-T	10	Standard Type	0.018 μ	±10	0.1	200	0.8±0.10	
MLAYL168SSD223KTNA01	LMK107 SD223KA-T	10	Standard Type	0.022 μ	±10	0.1	200	0.8±0.10	

## 2012TYPE

【Temperature Characteristic SD : Standard(-55~+125°C)】1.25mm thickness

New part number	Old part number (for reference)	Rated voltage [V]	Temperature characteristics	Capacitance [F]	Capacitance tolerance [%]	tan δ [%]	HTLT	Thickness*3 [mm]	Note
							Rated voltage x %		
MLAYG21GSSD183KTNA01	GMK212 SD183KG-T	35	Standard Type	0.018 μ	±10	0.1	200	1.25±0.10	
MLAYG21GSSD223KTNA01	GMK212 SD223KG-T	35	Standard Type	0.022 μ	±10	0.1	200	1.25±0.10	
MLAYG21GSSD273KTNA01	GMK212 SD273KG-T	35	Standard Type	0.027 μ	±10	0.1	200	1.25±0.10	
MLAYL21GSSD683KTNA01	LMK212 SD683KG-T	10	Standard Type	0.068 μ	±10	0.1	200	1.25±0.10	
MLAYL21GSSD823KTNA01	LMK212 SD823KG-T	10	Standard Type	0.082 μ	±10	0.1	200	1.25±0.10	
MLAYL21GSSD104KTNA01	LMK212 SD104KG-T	10	Standard Type	0.1 μ	±10	0.1	200	1.25±0.10	

【Temperature Characteristic SD : Standard(-55~+125°C)】0.85mm thickness

New part number	Old part number (for reference)	Rated voltage [V]	Temperature characteristics	Capacitance [F]	Capacitance tolerance [%]	tan δ [%]	HTLT	Thickness*3 [mm]	Note
							Rated voltage x %		
MLAYU219SSD392KTNA01	UMK212 SD392KD-T	50	Standard Type	3900 p	±10	0.1	200	0.85±0.10	
MLAYU219SSD472KTNA01	UMK212 SD472KD-T	50	Standard Type	4700 p	±10	0.1	200	0.85±0.10	
MLAYU219SSD562KTNA01	UMK212 SD562KD-T	50	Standard Type	5600 p	±10	0.1	200	0.85±0.10	
MLAYU219SSD682KTNA01	UMK212 SD682KD-T	50	Standard Type	6800 p	±10	0.1	200	0.85±0.10	
MLAYU219SSD822KTNA01	UMK212 SD822KD-T	50	Standard Type	8200 p	±10	0.1	200	0.85±0.10	
MLAYU219SSD103KTNA01	UMK212 SD103KD-T	50	Standard Type	0.01 μ	±10	0.1	200	0.85±0.10	
MLAYG219SSD123KTNA01	GMK212 SD123KD-T	35	Standard Type	0.012 μ	±10	0.1	200	0.85±0.10	
MLAYG219SSD153KTNA01	GMK212 SD153KD-T	35	Standard Type	0.015 μ	±10	0.1	200	0.85±0.10	
MLAYE219SSD333KTNA01	EMK212 SD333KD-T	16	Standard Type	0.033 μ	±10	0.1	200	0.85±0.10	
MLAYL219SSD473KTNA01	LMK212 SD473KD-T	10	Standard Type	0.047 μ	±10	0.1	200	0.85±0.10	

## PARTS NUMBER

## 3216TYPE

【Temperature Characteristic SD : Standard (−55~+125°C)】 1.6mm thickness

New part number	Old part number (for reference)	Rated voltage [V]	Temperature characteristics	Capacitance [F]	Capacitance tolerance [%]	tan δ [%]	HTLT	Thickness*3 [mm]	Note
							Rated voltage x %		
MLAYT31LSSD823KTNA01	TMK316 SD823KL-T	25	Standard Type	0.082 μ	±10	0.1	200	1.6±0.20	
MLAYT31LSSD104KTNA01	TMK316 SD104KL-T	25	Standard Type	0.1 μ	±10	0.1	200	1.6±0.20	

【Temperature Characteristic SD : Standard (−55~+125°C)】 1.15mm thickness

New part number	Old part number (for reference)	Rated voltage [V]	Temperature characteristics	Capacitance [F]	Capacitance tolerance [%]	tan δ [%]	HTLT	Thickness*3 [mm]	Note
							Rated voltage x %		
MLAYG31QHSD333KTNA01	GMK316 SD333KF-T	35	Standard Type	0.033 μ	±10	0.1	200	1.15±0.10	
MLAYG31QHSD393KTNA01	GMK316 SD393KF-T	35	Standard Type	0.039 μ	±10	0.1	200	1.15±0.10	
MLAYT31QHSD473KTNA01	TMK316 SD473KF-T	25	Standard Type	0.047 μ	±10	0.1	200	1.15±0.10	
MLAYT31QHSD563KTNA01	TMK316 SD563KF-T	25	Standard Type	0.056 μ	±10	0.1	200	1.15±0.10	
MLAYT31QHSD683KTNA01	TMK316 SD683KF-T	25	Standard Type	0.068 μ	±10	0.1	200	1.15±0.10	

## PARTS NUMBER

## Low distortion design/Audible/Good bias Multilayer Ceramic Capacitors (CF LD) for Medical Devices classified as GHTF Classes A or B (Japan Classes I or II)

## ● 1608TYPE

【Temperature Characteristic LD : X5R (−55~+85°C)】 0.8mm thickness

New part number	Old part number (for reference)	Rated voltage [V]	Temperature characteristics	Capacitance [F]	Capacitance tolerance [%]	tan δ [%]	HTLT	Thickness*3 [mm]	Note
							Rated voltage x %		
MLAYU168BLD224□TNA01	UMK107BLD224□A-T	50	X5R	0.22 μ	±10, ±20	10	150	0.8+0.20/-0	
MLAYT168BLD474□TNA01	TMK107BLD474□A-T	25	X5R	0.47 μ	±10, ±20	10	150	0.8+0.20/-0	
MLAYT168BLD105□TNA01	TMK107BLD105□A-T	25	X5R	1 μ	±10, ±20	10	150	0.8+0.20/-0	

## ● 2012TYPE

【Temperature Characteristic LD : X5R (−55~+85°C)】 1.25mm thickness

New part number	Old part number (for reference)	Rated voltage [V]	Temperature characteristics	Capacitance [F]	Capacitance tolerance [%]	tan δ [%]	HTLT	Thickness*3 [mm]	Note
							Rated voltage x %		
MLAYG21GSLD105□TNA01	GMK212 LD105□G-T	35	X5R	1 μ	±10, ±20	10	150	1.25±0.10	
MLAYG21GBLD225□TNA01	GMK212BLD225□G-T	35	X5R	2.2 μ	±10, ±20	10	150	1.25+0.20/-0	

## ● 3216TYPE

【Temperature Characteristic LD : X5R (−55~+85°C)】 1.6mm thickness

New part number	Old part number (for reference)	Rated voltage [V]	Temperature characteristics	Capacitance [F]	Capacitance tolerance [%]	tan δ [%]	HTLT	Thickness*3 [mm]	Note
							Rated voltage x %		
MLAYU31LSLD105□TNA01	UMK316 LD105□L-T	50	X5R	1 μ	±10, ±20	10	150	1.6±0.20	
MLAYG31LBLD475□TNA01	GMK316BLD475□L-T	35	X5R	4.7 μ	±10, ±20	10	150	1.6±0.30	
MLAYT31LBD106□TNA01	TMK316BLD106□L-T	25	X5R	10 μ	±10, ±20	10	150	1.6±0.30	

## ● 3225TYPE

【Temperature Characteristic LD : X5R (−55~+85°C)】 1.9mm thickness

New part number	Old part number (for reference)	Rated voltage [V]	Temperature characteristics	Capacitance [F]	Capacitance tolerance [%]	tan δ [%]	HTLT	Thickness*3 [mm]	Note
							Rated voltage x %		
MLAYU32NSLD105□TNA01	UMK325 LD105□N-T	50	X5R	1 μ	±10, ±20	10	200	1.9±0.20	

【Temperature Characteristic LD : X5R (−55~+85°C)】 2.5mm thickness

New part number	Old part number (for reference)	Rated voltage [V]	Temperature characteristics	Capacitance [F]	Capacitance tolerance [%]	tan δ [%]	HTLT	Thickness*3 [mm]	Note
							Rated voltage x %		
MLAYU32MSLD475□PNA01	UMK325 LD475□M-P	50	X5R	4.7 μ	±10, ±20	10	200	2.5±0.20	



## PARTS NUMBER

## Medium-High Voltage Multilayer Ceramic Capacitors for Medical Devices classified as GHTF Classes A or B (Japan Classes I or II)

## ● 1005TYPE

【Temperature Characteristic B7 : X7R (−55~+125°C)】 0.5mm thickness

New part number	Old part number (for reference)	Rated voltage [V]	Temperature characteristics		Capacitance [F]	Capacitance tolerance [%]	tan δ [%]	HTLT	Thickness*3 [mm]	Note
								Rated voltage x %		
MLASH105SB7221[FNA01]	HMK105 B7221[V-F]	100		X7R	220 p	±10, ±20	2.5	200	0.5±0.05	
MLASH105SB7331[FNA01]	HMK105 B7331[V-F]	100		X7R	330 p	±10, ±20	2.5	200	0.5±0.05	
MLASH105SB7471[FNA01]	HMK105 B7471[V-F]	100		X7R	470 p	±10, ±20	2.5	200	0.5±0.05	
MLASH105SB7681[FNA01]	HMK105 B7681[V-F]	100		X7R	680 p	±10, ±20	2.5	200	0.5±0.05	
MLASH105SB7102[FNA01]	HMK105 B7102[V-F]	100		X7R	1000 p	±10, ±20	2.5	200	0.5±0.05	
MLASH105SB7152[FNA01]	HMK105 B7152[V-F]	100		X7R	1500 p	±10, ±20	2.5	200	0.5±0.05	
MLASH105SB7222[FNA01]	HMK105 B7222[V-F]	100		X7R	2200 p	±10, ±20	2.5	200	0.5±0.05	
MLASH105SB7332[FNA01]	HMK105 B7332[V-F]	100		X7R	3300 p	±10, ±20	2.5	200	0.5±0.05	
MLASH105SB7472[FNA01]	HMK105 B7472[V-F]	100		X7R	4700 p	±10, ±20	2.5	200	0.5±0.05	

【Temperature Characteristic CH : CH/C0H (−55~+125°C)】 0.5mm thickness

New part number	Old part number (for reference)	Rated voltage [V]	Temperature characteristics		Capacitance [F]	Capacitance tolerance	Q (at 1MHz) (min)	HTLT	Thickness*3 [mm]	Note
								Rated voltage x %		
MLASH105SCH080DFNA01	HMK105 CH080DV-F	100	CH	C0H	8 p	±0.5pF	560	200	0.5±0.05	
MLASH105SCH090DFNA01	HMK105 CH090DV-F	100	CH	C0H	9 p	±0.5pF	580	200	0.5±0.05	
MLASH105SCH100DFNA01	HMK105 CH100DV-F	100	CH	C0H	10 p	±0.5pF	600	200	0.5±0.05	
MLASH105SCH120JFNA01	HMK105 CH120JV-F	100	CH	C0H	12 p	±5%	640	200	0.5±0.05	
MLASH105SCH150JFNA01	HMK105 CH150JV-F	100	CH	C0H	15 p	±5%	700	200	0.5±0.05	
MLASH105SCH180JFNA01	HMK105 CH180JV-F	100	CH	C0H	18 p	±5%	760	200	0.5±0.05	
MLASH105SCH220JFNA01	HMK105 CH220JV-F	100	CH	C0H	22 p	±5%	840	200	0.5±0.05	
MLASH105SCH240JFNA01	HMK105 CH240JV-F	100	CH	C0H	24 p	±5%	880	200	0.5±0.05	
MLASH105SCH270JFNA01	HMK105 CH270JV-F	100	CH	C0H	27 p	±5%	940	200	0.5±0.05	
MLASH105SCH330JFNA01	HMK105 CH330JV-F	100	CH	C0H	33 p	±5%	1000	200	0.5±0.05	
MLASH105SCH390JFNA01	HMK105 CH390JV-F	100	CH	C0H	39 p	±5%	1000	200	0.5±0.05	
MLASH105SCH470JFNA01	HMK105 CH470JV-F	100	CH	C0H	47 p	±5%	1000	200	0.5±0.05	
MLASH105SCH560JFNA01	HMK105 CH560JV-F	100	CH	C0H	56 p	±5%	1000	200	0.5±0.05	
MLASH105SCH680JFNA01	HMK105 CH680JV-F	100	CH	C0H	68 p	±5%	1000	200	0.5±0.05	
MLASH105SCH820JFNA01	HMK105 CH820JV-F	100	CH	C0H	82 p	±5%	1000	200	0.5±0.05	
MLASH105SCH101JFNA01	HMK105 CH101JV-F	100	CH	C0H	100 p	±5%	1000	200	0.5±0.05	

【Temperature Characteristic CG : CG/C0G (−55~+125°C)】 0.5mm thickness

New part number	Old part number (for reference)	Rated voltage [V]	Temperature characteristics		Capacitance [F]	Capacitance tolerance	Q (at 1MHz) (min)	HTLT	Thickness*3 [mm]	Note
								Rated voltage x %		
MLASH105SCG080DFNA01	HMK105 CG080DV-F	100	CG	C0G	8 p	±0.5pF	560	200	0.5±0.05	
MLASH105SCG090DFNA01	HMK105 CG090DV-F	100	CG	C0G	9 p	±0.5pF	580	200	0.5±0.05	
MLASH105SCG100DFNA01	HMK105 CG100DV-F	100	CG	C0G	10 p	±0.5pF	600	200	0.5±0.05	
MLASH105SCG120JFNA01	HMK105 CG120JV-F	100	CG	C0G	12 p	±5%	640	200	0.5±0.05	
MLASH105SCG150JFNA01	HMK105 CG150JV-F	100	CG	C0G	15 p	±5%	700	200	0.5±0.05	
MLASH105SCG180JFNA01	HMK105 CG180JV-F	100	CG	C0G	18 p	±5%	760	200	0.5±0.05	
MLASH105SCG220JFNA01	HMK105 CG220JV-F	100	CG	C0G	22 p	±5%	840	200	0.5±0.05	
MLASH105SCG240JFNA01	HMK105 CG240JV-F	100	CG	C0G	24 p	±5%	880	200	0.5±0.05	
MLASH105SCG270JFNA01	HMK105 CG270JV-F	100	CG	C0G	27 p	±5%	940	200	0.5±0.05	
MLASH105SCG330JFNA01	HMK105 CG330JV-F	100	CG	C0G	33 p	±5%	1000	200	0.5±0.05	
MLASH105SCG390JFNA01	HMK105 CG390JV-F	100	CG	C0G	39 p	±5%	1000	200	0.5±0.05	
MLASH105SCG470JFNA01	HMK105 CG470JV-F	100	CG	C0G	47 p	±5%	1000	200	0.5±0.05	
MLASH105SCG560JFNA01	HMK105 CG560JV-F	100	CG	C0G	56 p	±5%	1000	200	0.5±0.05	
MLASH105SCG680JFNA01	HMK105 CG680JV-F	100	CG	C0G	68 p	±5%	1000	200	0.5±0.05	
MLASH105SCG820JFNA01	HMK105 CG820JV-F	100	CG	C0G	82 p	±5%	1000	200	0.5±0.05	
MLASH105SCG101JFNA01	HMK105 CG101JV-F	100	CG	C0G	100 p	±5%	1000	200	0.5±0.05	

## ● 1608TYPE

【Temperature Characteristic B5(BJ) : B (−25~+85°C)/X5R (−55~+85°C)】 0.8mm thickness

New part number	Old part number (for reference)	Rated voltage [V]	Temperature characteristics		Capacitance [F]	Capacitance tolerance [%]	tan δ [%]	HTLT	Thickness*3 [mm]	Note
								Rated voltage x %		
MLASH168SB5102[TNA01]	HMK107 BJ102[A-T]	100	B	X5R <sup>+</sup>	1000 p	±10, ±20	3.5	200	0.8±0.10	
MLASH168SB5152[TNA01]	HMK107 BJ152[A-T]	100	B	X5R <sup>+</sup>	1500 p	±10, ±20	3.5	200	0.8±0.10	
MLASH168SB5222[TNA01]	HMK107 BJ222[A-T]	100	B	X5R <sup>+</sup>	2200 p	±10, ±20	3.5	200	0.8±0.10	
MLASH168SB5332[TNA01]	HMK107 BJ332[A-T]	100	B	X5R <sup>+</sup>	3300 p	±10, ±20	3.5	200	0.8±0.10	
MLASH168SB5472[TNA01]	HMK107 BJ472[A-T]	100	B	X5R <sup>+</sup>	4700 p	±10, ±20	3.5	200	0.8±0.10	
MLASH168SB5682[TNA01]	HMK107 BJ682[A-T]	100	B	X5R <sup>+</sup>	6800 p	±10, ±20	3.5	200	0.8±0.10	
MLASH168SB5103[TNA01]	HMK107 BJ103[A-T]	100	B	X5R <sup>+</sup>	0.01 μ	±10, ±20	3.5	200	0.8±0.10	
MLASH168SB5153[TNA01]	HMK107 BJ153[A-T]	100	B	X5R <sup>+</sup>	0.015 μ	±10, ±20	3.5	200	0.8±0.10	
MLASH168SB5223[TNA01]	HMK107 BJ223[A-T]	100	B	X5R <sup>+</sup>	0.022 μ	±10, ±20	3.5	200	0.8±0.10	
MLASH168SB5333[TNA01]	HMK107 BJ333[A-T]	100	B	X5R <sup>+</sup>	0.033 μ	±10, ±20	3.5	200	0.8±0.10	
MLASH168SB5473[TNA01]	HMK107 BJ473[A-T]	100	B	X5R <sup>+</sup>	0.047 μ	±10, ±20	3.5	200	0.8±0.10	
MLASH168SB5104[TNA01]	HMK107 BJ104[A-T]	100	B	X5R <sup>+</sup>	0.1 μ	±10, ±20	3.5	200	0.8±0.10	
MLASH168SB5224[TCA01]	HMK107 BJ224[A-TE]	100	B	X5R <sup>+</sup>	0.22 μ	±10, ±20	3.5	150	0.8±0.10	

【Temperature Characteristic C7 : X7S (−55~+125°C)】 0.8mm thickness

New part number	Old part number (for reference)	Rated voltage [V]	Temperature characteristics		Capacitance [F]	Capacitance tolerance [%]	tan δ [%]	HTLT	Thickness*3 [mm]	Note
								Rated voltage x %		
MLASH168SC7224[TCA01]	HMK107 C7224[A-TE]	100		X7S	0.22 μ	±10, ±20	3.5	150	0.8±0.10	

## PARTS NUMBER

## 【Temperature Characteristic B7 : X7R (−55~+125°C)】 0.8mm thickness

New part number	Old part number (for reference)	Rated voltage [V]	Temperature characteristics		Capacitance [F]	Capacitance tolerance [%]	tan δ [%]	HTLT	Thickness*3 [mm]	Note
								Rated voltage x %		
MLASH168SB7102□TNA01	HMK107 B7102□A-T	100		X7R	1000 p	±10, ±20	3.5	200	0.8±0.10	
MLASH168SB7152□TNA01	HMK107 B7152□A-T	100		X7R	1500 p	±10, ±20	3.5	200	0.8±0.10	
MLASH168SB7222□TNA01	HMK107 B7222□A-T	100		X7R	2200 p	±10, ±20	3.5	200	0.8±0.10	
MLASH168SB7332□TNA01	HMK107 B7332□A-T	100		X7R	3300 p	±10, ±20	3.5	200	0.8±0.10	
MLASH168SB7472□TNA01	HMK107 B7472□A-T	100		X7R	4700 p	±10, ±20	3.5	200	0.8±0.10	
MLASH168SB7682□TNA01	HMK107 B7682□A-T	100		X7R	6800 p	±10, ±20	3.5	200	0.8±0.10	
MLASH168SB7103□TNA01	HMK107 B7103□A-T	100		X7R	0.01 μ	±10, ±20	3.5	200	0.8±0.10	
MLASH168SB7153□TNA01	HMK107 B7153□A-T	100		X7R	0.015 μ	±10, ±20	3.5	200	0.8±0.10	
MLASH168SB7223□TNA01	HMK107 B7223□A-T	100		X7R	0.022 μ	±10, ±20	3.5	200	0.8±0.10	
MLASH168SB7333□TNA01	HMK107 B7333□A-T	100		X7R	0.033 μ	±10, ±20	3.5	200	0.8±0.10	
MLASH168SB7473□TNA01	HMK107 B7473□A-T	100		X7R	0.047 μ	±10, ±20	3.5	200	0.8±0.10	
MLASH168SB7104□TNA01	HMK107 B7104□A-T	100		X7R	0.1 μ	±10, ±20	3.5	200	0.8±0.10	

## 【Temperature Characteristic SD : Standard (−55~+125°C)】 0.8mm thickness

New part number	Old part number (for reference)	Rated voltage [V]	Temperature characteristics		Capacitance [F]	Capacitance tolerance [%]	tan δ [%]	HTLT	Thickness*3 [mm]	Note
								Rated voltage x %		
MLASH168SSD101KTNA01	HMK107 SD101KA-T	100		Standard Type	100 p	±10	0.1	200	0.8±0.10	
MLASH168SSD121KTNA01	HMK107 SD121KA-T	100		Standard Type	120 p	±10	0.1	200	0.8±0.10	
MLASH168SSD151KTNA01	HMK107 SD151KA-T	100		Standard Type	150 p	±10	0.1	200	0.8±0.10	
MLASH168SSD181KTNA01	HMK107 SD181KA-T	100		Standard Type	180 p	±10	0.1	200	0.8±0.10	
MLASH168SSD221KTNA01	HMK107 SD221KA-T	100		Standard Type	220 p	±10	0.1	200	0.8±0.10	
MLASH168SSD271KTNA01	HMK107 SD271KA-T	100		Standard Type	270 p	±10	0.1	200	0.8±0.10	
MLASH168SSD331KTNA01	HMK107 SD331KA-T	100		Standard Type	330 p	±10	0.1	200	0.8±0.10	
MLASH168SSD391KTNA01	HMK107 SD391KA-T	100		Standard Type	390 p	±10	0.1	200	0.8±0.10	
MLASH168SSD471KTNA01	HMK107 SD471KA-T	100		Standard Type	470 p	±10	0.1	200	0.8±0.10	
MLASH168SSD561KTNA01	HMK107 SD561KA-T	100		Standard Type	560 p	±10	0.1	200	0.8±0.10	
MLASH168SSD681KTNA01	HMK107 SD681KA-T	100		Standard Type	680 p	±10	0.1	200	0.8±0.10	
MLASH168SSD821KTNA01	HMK107 SD821KA-T	100		Standard Type	820 p	±10	0.1	200	0.8±0.10	
MLASH168SSD102KTNA01	HMK107 SD102KA-T	100		Standard Type	1000 p	±10	0.1	200	0.8±0.10	

## 2012TYPE

## 【Temperature Characteristic B5(BJ) : B (−25~+85°C)/X5R (−55~+85°C)】 1.25mm thickness

New part number	Old part number (for reference)	Rated voltage [V]	Temperature characteristics		Capacitance [F]	Capacitance tolerance [%]	tan δ [%]	HTLT	Thickness*3 [mm]	Note
								Rated voltage x %		
MLASH21GSB5103□TNA01	HMK212 BJ103□G-T	100	B	X5R <sup>+</sup>	0.01 μ	±10, ±20	3.5	200	1.25±0.10	
MLASH21GSB5153□TNA01	HMK212 BJ153□G-T	100	B	X5R <sup>+</sup>	0.015 μ	±10, ±20	3.5	200	1.25±0.10	
MLASH21GSB5223□TNA01	HMK212 BJ223□G-T	100	B	X5R <sup>+</sup>	0.022 μ	±10, ±20	3.5	200	1.25±0.10	
MLASH21GSB5333□TNA01	HMK212 BJ333□G-T	100	B	X5R <sup>+</sup>	0.033 μ	±10, ±20	3.5	200	1.25±0.10	
MLASH21GSB5473□TNA01	HMK212 BJ473□G-T	100	B	X5R <sup>+</sup>	0.047 μ	±10, ±20	3.5	200	1.25±0.10	
MLASH21GSB5683□TNA01	HMK212 BJ683□G-T	100	B	X5R <sup>+</sup>	0.068 μ	±10, ±20	3.5	200	1.25±0.10	
MLASH21GSB5104□TNA01	HMK212 BJ104□G-T	100	B	X5R <sup>+</sup>	0.1 μ	±10, ±20	3.5	200	1.25±0.10	
MLASH21GSB5224□TNA01	HMK212 BJ224□G-T	100	B	X5R <sup>+</sup>	0.22 μ	±10, ±20	3.5	200	1.25±0.10	
MLASH21GSB5474□TCA01	HMK212 BJ474□G-TE	100	B	X5R <sup>+</sup>	0.47 μ	±10, ±20	3.5	150	1.25±0.10	
MLASH21GGB5105□TCA01	HMK212BBJ105□G-TE	100	B	X5R <sup>+</sup>	1 μ	±10, ±20	3.5	150	1.25+0.20/-0	
MLASQ21GSB5472□TNA01	QMK212 BJ472□G-T	250	B	X5R <sup>+</sup>	4700 p	±10, ±20	2.5	150	1.25±0.10	
MLASQ21GSB5682□TNA01	QMK212 BJ682□G-T	250	B	X5R <sup>+</sup>	6800 p	±10, ±20	2.5	150	1.25±0.10	
MLASQ21GSB5103□TNA01	QMK212 BJ103□G-T	250	B	X5R <sup>+</sup>	0.01 μ	±10, ±20	2.5	150	1.25±0.10	
MLASQ21GSB5153□TNA01	QMK212 BJ153□G-T	250	B	X5R <sup>+</sup>	0.015 μ	±10, ±20	2.5	150	1.25±0.10	
MLASQ21GSB5223□TNA01	QMK212 BJ223□G-T	250	B	X5R <sup>+</sup>	0.022 μ	±10, ±20	2.5	150	1.25±0.10	

## 【Temperature Characteristic B5(BJ) : B (−25~+85°C)/X5R (−55~+85°C)】 0.85mm thickness

New part number	Old part number (for reference)	Rated voltage [V]	Temperature characteristics		Capacitance [F]	Capacitance tolerance [%]	tan δ [%]	HTLT	Thickness*3 [mm]	Note
								Rated voltage x %		
MLASQ219SB5102□TNA01	QMK212 BJ102□D-T	250	B	X5R <sup>+</sup>	1000 p	±10, ±20	2.5	150	0.85±0.10	
MLASQ219SB5152□TNA01	QMK212 BJ152□D-T	250	B	X5R <sup>+</sup>	1500 p	±10, ±20	2.5	150	0.85±0.10	
MLASQ219SB5222□TNA01	QMK212 BJ222□D-T	250	B	X5R <sup>+</sup>	2200 p	±10, ±20	2.5	150	0.85±0.10	
MLASQ219SB5332□TNA01	QMK212 BJ332□D-T	250	B	X5R <sup>+</sup>	3300 p	±10, ±20	2.5	150	0.85±0.10	

## 【Temperature Characteristic C7 : X7S (−55~+125°C)】 1.25mm thickness

New part number	Old part number (for reference)	Rated voltage [V]	Temperature characteristics		Capacitance [F]	Capacitance tolerance [%]	tan δ [%]	HTLT	Thickness*3 [mm]	Note
								Rated voltage x %		
MLASH21GSC7474□TCA01	HMK212 C7474□G-TE	100		X7S	0.47 μ	±10, ±20	3.5	150	1.25±0.10	
MLASH21GBC7105□TCA01	HMK212BC7105□G-TE	100		X7S	1 μ	±10, ±20	3.5	150	1.25+0.20/-0	

PARTS NUMBER

【Temperature Characteristic B7 : X7R (−55~+125°C)】 1.25mm thickness

New part number	Old part number (for reference)	Rated voltage [V]	Temperature characteristics		Capacitance [F]	Capacitance tolerance [%]	tan δ [%]	HTLT	Thickness*3 [mm]	Note
								Rated voltage x %		
MLASH21GSB7103□TNA01	HMK212 B7103□G-T	100		X7R	0.01 μ	±10, ±20	3.5	200	1.25±0.10	
MLASH21GSB7153□TNA01	HMK212 B7153□G-T	100		X7R	0.015 μ	±10, ±20	3.5	200	1.25±0.10	
MLASH21GSB7223□TNA01	HMK212 B7223□G-T	100		X7R	0.022 μ	±10, ±20	3.5	200	1.25±0.10	
MLASH21GSB7333□TNA01	HMK212 B7333□G-T	100		X7R	0.033 μ	±10, ±20	3.5	200	1.25±0.10	
MLASH21GSB7473□TNA01	HMK212 B7473□G-T	100		X7R	0.047 μ	±10, ±20	3.5	200	1.25±0.10	
MLASH21GSB7683□TNA01	HMK212 B7683□G-T	100		X7R	0.068 μ	±10, ±20	3.5	200	1.25±0.10	
MLASH21GSB7104□TNA01	HMK212 B7104□G-T	100		X7R	0.1 μ	±10, ±20	3.5	200	1.25±0.10	
MLASH21GSB7224□TNA01	HMK212 B7224□G-T	100		X7R	0.22 μ	±10, ±20	3.5	200	1.25±0.10	
MLASQ21GSB7472□TNA01	QMK212 B7472□G-T	250		X7R	4700 p	±10, ±20	2.5	150	1.25±0.10	
MLASQ21GSB7682□TNA01	QMK212 B7682□G-T	250		X7R	6800 p	±10, ±20	2.5	150	1.25±0.10	
MLASQ21GSB7103□TNA01	QMK212 B7103□G-T	250		X7R	0.01 μ	±10, ±20	2.5	150	1.25±0.10	
MLASQ21GSB7153□TNA01	QMK212 B7153□G-T	250		X7R	0.015 μ	±10, ±20	2.5	150	1.25±0.10	
MLASQ21GSB7223□TNA01	QMK212 B7223□G-T	250		X7R	0.022 μ	±10, ±20	2.5	150	1.25±0.10	

【Temperature Characteristic B7 : X7R (−55~+125°C)】 0.85mm thickness

New part number	Old part number (for reference)	Rated voltage [V]	Temperature characteristics		Capacitance [F]	Capacitance tolerance [%]	tan δ [%]	HTLT	Thickness*3 [mm]	Note
								Rated voltage x %		
MLASQ219SB7102□TNA01	QMK212 B7102□D-T	250		X7R	1000 p	±10, ±20	2.5	150	0.85±0.10	
MLASQ219SB7152□TNA01	QMK212 B7152□D-T	250		X7R	1500 p	±10, ±20	2.5	150	0.85±0.10	
MLASQ219SB7222□TNA01	QMK212 B7222□D-T	250		X7R	2200 p	±10, ±20	2.5	150	0.85±0.10	
MLASQ219SB7332□TNA01	QMK212 B7332□D-T	250		X7R	3300 p	±10, ±20	2.5	150	0.85±0.10	

【Temperature Characteristic SD : Standard (−55~+125°C)】 0.85mm thickness

New part number	Old part number (for reference)	Rated voltage [V]	Temperature characteristics		Capacitance [F]	Capacitance tolerance [%]	tan δ [%]	HTLT	Thickness*3 [mm]	Note
								Rated voltage x %		
MLASH219SSD222KTNA01	HMK212 SD222KD-T	100		Standard Type	2200 p	±10	0.1	200	0.85±0.10	
MLASH219SSD472KTNA01	HMK212 SD472KD-T	100		Standard Type	4700 p	±10	0.1	200	0.85±0.10	
MLASQ219SSD101KTNA01	QMK212 SD101KD-T	250		Standard Type	100 p	±10	0.1	150	0.85±0.10	
MLASQ219SSD121KTNA01	QMK212 SD121KD-T	250		Standard Type	120 p	±10	0.1	150	0.85±0.10	
MLASQ219SSD151KTNA01	QMK212 SD151KD-T	250		Standard Type	150 p	±10	0.1	150	0.85±0.10	
MLASQ219SSD181KTNA01	QMK212 SD181KD-T	250		Standard Type	180 p	±10	0.1	150	0.85±0.10	
MLASQ219SSD221KTNA01	QMK212 SD221KD-T	250		Standard Type	220 p	±10	0.1	150	0.85±0.10	
MLASQ219SSD331KTNA01	QMK212 SD331KD-T	250		Standard Type	330 p	±10	0.1	150	0.85±0.10	
MLASQ219SSD391KTNA01	QMK212 SD391KD-T	250		Standard Type	390 p	±10	0.1	150	0.85±0.10	
MLASQ219SSD471KTNA01	QMK212 SD471KD-T	250		Standard Type	470 p	±10	0.1	150	0.85±0.10	
MLASQ219SSD561KTNA01	QMK212 SD561KD-T	250		Standard Type	560 p	±10	0.1	150	0.85±0.10	
MLASQ219SSD681KTNA01	QMK212 SD681KD-T	250		Standard Type	680 p	±10	0.1	150	0.85±0.10	
MLASQ219SSD821KTNA01	QMK212 SD821KD-T	250		Standard Type	820 p	±10	0.1	150	0.85±0.10	
MLASQ219SSD102KTNA01	QMK212 SD102KD-T	250		Standard Type	1000 p	±10	0.1	150	0.85±0.10	

【Temperature Characteristic SD : Standard (−55~+125°C)】 1.25mm thickness

New part number	Old part number (for reference)	Rated voltage [V]	Temperature characteristics		Capacitance [F]	Capacitance tolerance [%]	tan δ [%]	HTLT	Thickness*3 [mm]	Note
								Rated voltage x %		
MLASH21GSSD392KTNA01	HMK212 SD392KG-T	100		Standard Type	3900 p	±10	0.1	200	1.25±0.10	

3216TYPE

【Temperature Characteristic B5(BJ) : B (−25~+85°C)/X5R (−55~+85°C)】 1.6mm thickness

New part number	Old part number (for reference)	Rated voltage [V]	Temperature characteristics		Capacitance [F]	Capacitance tolerance [%]	tan δ [%]	HTLT	Thickness*3 [mm]	Note
								Rated voltage x %		
MLASH31LSB5473□TNA01	HMK316 BJ473□L-T	100	B	X5R <sup>+</sup>	0.047 μ	±10, ±20	3.5	200	1.6±0.20	
MLASH31LSB5683□TNA01	HMK316 BJ683□L-T	100	B	X5R <sup>+</sup>	0.068 μ	±10, ±20	3.5	200	1.6±0.20	
MLASH31LSB5104□TNA01	HMK316 BJ104□L-T	100	B	X5R <sup>+</sup>	0.1 μ	±10, ±20	3.5	200	1.6±0.20	
MLASH31LSB5154□TNA01	HMK316 BJ154□L-T	100	B	X5R <sup>+</sup>	0.15 μ	±10, ±20	3.5	200	1.6±0.20	
MLASH31LSB5224□TNA01	HMK316 BJ224□L-T	100	B	X5R <sup>+</sup>	0.22 μ	±10, ±20	3.5	200	1.6±0.20	
MLASH31LSB5334□TNA01	HMK316 BJ334□L-T	100	B	X5R <sup>+</sup>	0.33 μ	±10, ±20	3.5	200	1.6±0.20	
MLASH31LSB5474□TNA01	HMK316 BJ474□L-T	100	B	X5R <sup>+</sup>	0.47 μ	±10, ±20	3.5	200	1.6±0.20	
MLASH31LSB5105□TNA01	HMK316 BJ105□L-T	100	B	X5R <sup>+</sup>	1 μ	±10, ±20	3.5	200	1.6±0.20	
MLASH31LAB5225□TCA01	HMK316 ABJ225□L-TE	100	B	X5R <sup>+</sup>	2.2 μ	±10, ±20	3.5	150	1.6±0.20	
MLASQ31LSB5333□TNA01	QMK316 BJ333□L-T	250	B	X5R <sup>+</sup>	0.033 μ	±10, ±20	2.5	150	1.6±0.20	
MLASQ31LSB5473□TNA01	QMK316 BJ473□L-T	250	B	X5R <sup>+</sup>	0.047 μ	±10, ±20	2.5	150	1.6±0.20	
MLASQ31LSB5683□TNA01	QMK316 BJ683□L-T	250	B	X5R <sup>+</sup>	0.068 μ	±10, ±20	2.5	150	1.6±0.20	
MLASQ31LSB5104□TNA01	QMK316 BJ104□L-T	250	B	X5R <sup>+</sup>	0.1 μ	±10, ±20	2.5	150	1.6±0.20	
MLASS31LSB5153□TNA01	SMK316 BJ153□L-T	630	B	X5R <sup>+</sup>	0.015 μ	±10, ±20	2.5	120	1.6±0.20	
MLASS31LSB5223□TNA01	SMK316 BJ223□L-T	630	B	X5R <sup>+</sup>	0.022 μ	±10, ±20	2.5	120	1.6±0.20	

【Temperature Characteristic B5(BJ) : B (−25~+85°C)/X5R (−55~+85°C)】 1.15mm thickness

New part number	Old part number (for reference)	Rated voltage [V]	Temperature characteristics		Capacitance [F]	Capacitance tolerance [%]	tan δ [%]	HTLT	Thickness*3 [mm]	Note
								Rated voltage x %		
MLASS31QHB5102□TNA01	SMK316 BJ102□F-T	630	B	X5R <sup>+</sup>	1000 p	±10, ±20	2.5	120	1.15±0.10	
MLASS31QHB5152□TNA01	SMK316 BJ152□F-T	630	B	X5R <sup>+</sup>	1500 p	±10, ±20	2.5	120	1.15±0.10	
MLASS31QHB5222□TNA01	SMK316 BJ222□F-T	630	B	X5R <sup>+</sup>	2200 p	±10, ±20	2.5	120	1.15±0.10	
MLASS31QHB5332□TNA01	SMK316 BJ332□F-T	630	B	X5R <sup>+</sup>	3300 p	±10, ±20	2.5	120	1.15±0.10	
MLASS31QHB5472□TNA01	SMK316 BJ472□F-T	630	B	X5R <sup>+</sup>	4700 p	±10, ±20	2.5	120	1.15±0.10	
MLASS31QHB5682□TNA01	SMK316 BJ682□F-T	630	B	X5R <sup>+</sup>	6800 p	±10, ±20	2.5	120	1.15±0.10	
MLASS31QHB5103□TNA01	SMK316 BJ103□F-T	630	B	X5R <sup>+</sup>	0.01 μ	±10, ±20	2.5	120	1.15±0.10	

▶ This catalog contains the typical specification only due to the limitation of space. When you consider the purchase of our products, please check our specification. For details of each product (characteristics graph, reliability information, precautions for use, and so on), see our Web site (<http://www.ty-top.com/>).

■ PARTS NUMBER

【Temperature Characteristic C7 : X7S (−55~+125°C)】 1.6mm thickness

New part number	Old part number (for reference)	Rated voltage [V]	Temperature characteristics	Capacitance [F]	Capacitance tolerance [%]	tan δ [%]	HTLT	Thickness*3 [mm]	Note
							Rated voltage x %		
MLASH31LAC7225□TCA01	HMK316AC7225□L-TE	100	X7S	2.2 μ	±10, ±20	3.5	150	1.6±0.20	

【Temperature Characteristic B7 : X7R (−55~+125°C)】 1.6mm thickness

New part number	Old part number (for reference)	Rated voltage [V]	Temperature characteristics	Capacitance [F]	Capacitance tolerance [%]	tan δ [%]	HTLT	Thickness*3 [mm]	Note
							Rated voltage x %		
MLASH31LSB7473□TNA01	HMK316 B7473□L-T	100	X7R	0.047 μ	±10, ±20	3.5	200	1.6±0.20	
MLASH31LSB7683□TNA01	HMK316 B7683□L-T	100	X7R	0.068 μ	±10, ±20	3.5	200	1.6±0.20	
MLASH31LSB7104□TNA01	HMK316 B7104□L-T	100	X7R	0.1 μ	±10, ±20	3.5	200	1.6±0.20	
MLASH31LSB7154□TNA01	HMK316 B7154□L-T	100	X7R	0.15 μ	±10, ±20	3.5	200	1.6±0.20	
MLASH31LSB7224□TNA01	HMK316 B7224□L-T	100	X7R	0.22 μ	±10, ±20	3.5	200	1.6±0.20	
MLASH31LSB7334□TNA01	HMK316 B7334□L-T	100	X7R	0.33 μ	±10, ±20	3.5	200	1.6±0.20	
MLASH31LSB7474□TNA01	HMK316 B7474□L-T	100	X7R	0.47 μ	±10, ±20	3.5	200	1.6±0.20	
MLASH31LSB7105□TNA01	HMK316 B7105□L-T	100	X7R	1 μ	±10, ±20	3.5	200	1.6±0.20	
MLASQ31LSB7333□TNA01	QMK316 B7333□L-T	250	X7R	0.033 μ	±10, ±20	2.5	150	1.6±0.20	
MLASQ31LSB7473□TNA01	QMK316 B7473□L-T	250	X7R	0.047 μ	±10, ±20	2.5	150	1.6±0.20	
MLASQ31LSB7683□TNA01	QMK316 B7683□L-T	250	X7R	0.068 μ	±10, ±20	2.5	150	1.6±0.20	
MLASQ31LSB7104□TNA01	QMK316 B7104□L-T	250	X7R	0.1 μ	±10, ±20	2.5	150	1.6±0.20	
MLASS31LSB7153□TNA01	SMK316 B7153□L-T	630	X7R	0.015 μ	±10, ±20	2.5	120	1.6±0.20	
MLASS31LSB7223□TNA01	SMK316 B7223□L-T	630	X7R	0.022 μ	±10, ±20	2.5	120	1.6±0.20	
MLASS31LAB7333□TNA01	SMK316AB7333□L-T	630	X7R	0.033 μ	±10, ±20	2.5	120	1.6±0.20	
MLASS31LAB7473□TNA01	SMK316AB7473□L-T	630	X7R	0.047 μ	±10, ±20	2.5	120	1.6±0.20	

【Temperature Characteristic B7 : X7R (−55~+125°C)】 1.15mm thickness

New part number	Old part number (for reference)	Rated voltage [V]	Temperature characteristics	Capacitance [F]	Capacitance tolerance [%]	tan δ [%]	HTLT	Thickness*3 [mm]	Note
							Rated voltage x %		
MLASS31QHB7102□TNA01	SMK316 B7102□F-T	630	X7R	1000 p	±10, ±20	2.5	120	1.15±0.10	
MLASS31QHB7152□TNA01	SMK316 B7152□F-T	630	X7R	1500 p	±10, ±20	2.5	120	1.15±0.10	
MLASS31QHB7222□TNA01	SMK316 B7222□F-T	630	X7R	2200 p	±10, ±20	2.5	120	1.15±0.10	
MLASS31QHB7332□TNA01	SMK316 B7332□F-T	630	X7R	3300 p	±10, ±20	2.5	120	1.15±0.10	
MLASS31QHB7472□TNA01	SMK316 B7472□F-T	630	X7R	4700 p	±10, ±20	2.5	120	1.15±0.10	
MLASS31QHB7682□TNA01	SMK316 B7682□F-T	630	X7R	6800 p	±10, ±20	2.5	120	1.15±0.10	
MLASS31QHB7103□TNA01	SMK316 B7103□F-T	630	X7R	0.01 μ	±10, ±20	2.5	120	1.15±0.10	

【Temperature Characteristic SD : Standard (−55~+125°C)】 1.6mm thickness

New part number	Old part number (for reference)	Rated voltage [V]	Temperature characteristics	Capacitance [F]	Capacitance tolerance [%]	tan δ [%]	HTLT	Thickness*3 [mm]	Note
							Rated voltage x %		
MLASH31LSSD223KTNA01	HMK316 SD223KL-T	100	Standard Type	0.022 μ	±10	0.1	200	1.6±0.20	
MLASQ31LSSD103KTNA01	QMK316 SD103KL-T	250	Standard Type	0.01 μ	±10	0.1	150	1.6±0.20	

● 3225TYPE

【Temperature Characteristic B5(BJ) : B (−25~+85°C)/X5R (−55~+85°C)】 2.5mm thickness

New part number	Old part number (for reference)	Rated voltage [V]	Temperature characteristics	Capacitance [F]	Capacitance tolerance [%]	tan δ [%]	HTLT	Thickness*3 [mm]	Note
							Rated voltage x %		
MLASH32MSB5225□PNA01	HMK325 BJ225□M-P	100	B X5R*1	2.2 μ	±10, ±20	3.5	200	2.5±0.20	
MLASH32MSB5475□PCA01	HMK325 BJ475□M-PE	100	B X5R*1	4.7 μ	±10, ±20	3.5	150	2.5±0.20	

【Temperature Characteristic B5(BJ) : B (−25~+85°C)/X5R (−55~+85°C)】 1.9mm thickness

New part number	Old part number (for reference)	Rated voltage [V]	Temperature characteristics	Capacitance [F]	Capacitance tolerance [%]	tan δ [%]	HTLT	Thickness*3 [mm]	Note
							Rated voltage x %		
MLASH32NSB5154□TNA01	HMK325 BJ154□N-T	100	B X5R*1	0.15 μ	±10, ±20	3.5	200	1.9±0.20	
MLASH32NSB5224□TNA01	HMK325 BJ224□N-T	100	B X5R*1	0.22 μ	±10, ±20	3.5	200	1.9±0.20	
MLASH32NSB5334□TNA01	HMK325 BJ334□N-T	100	B X5R*1	0.33 μ	±10, ±20	3.5	200	1.9±0.20	
MLASH32NSB5474□TNA01	HMK325 BJ474□N-T	100	B X5R*1	0.47 μ	±10, ±20	3.5	200	1.9±0.20	
MLASH32NSB5684□TNA01	HMK325 BJ684□N-T	100	B X5R*1	0.68 μ	±10, ±20	3.5	200	1.9±0.20	
MLASH32NSB5105□TNA01	HMK325 BJ105□N-T	100	B X5R*1	1 μ	±10, ±20	3.5	200	1.9±0.20	
MLASH32NSB5475□TCA01	HMK325 BJ475□N-TE	100	B X5R*1	4.7 μ	±10, ±20	3.5	150	1.9±0.20	
MLASQ32NSB5473□TNA01	QMK325 BJ473□N-T	250	B X5R*1	0.047 μ	±10, ±20	2.5	150	1.9±0.20	
MLASQ32NSB5104□TNA01	QMK325 BJ104□N-T	250	B X5R*1	0.1 μ	±10, ±20	2.5	150	1.9±0.20	
MLASQ32NSB5154□TNA01	QMK325 BJ154□N-T	250	B X5R*1	0.15 μ	±10, ±20	2.5	150	1.9±0.20	
MLASQ32NSB5224□TNA01	QMK325 BJ224□N-T	250	B X5R*1	0.22 μ	±10, ±20	2.5	150	1.9±0.20	
MLASS32NSB5223□TNA01	SMK325 BJ223□N-T	630	B X5R*1	0.022 μ	±10, ±20	2.5	120	1.9±0.20	
MLASS32NSB5333□TNA01	SMK325 BJ333□N-T	630	B X5R*1	0.033 μ	±10, ±20	2.5	120	1.9±0.20	
MLASS32NSB5473□TNA01	SMK325 BJ473□N-T	630	B X5R*1	0.047 μ	±10, ±20	2.5	120	1.9±0.20	

【Temperature Characteristic B5(BJ) : B (−25~+85°C)/X5R (−55~+85°C)】 1.15mm thickness

New part number	Old part number (for reference)	Rated voltage [V]	Temperature characteristics	Capacitance [F]	Capacitance tolerance [%]	tan δ [%]	HTLT	Thickness*3 [mm]	Note
							Rated voltage x %		
MLASH32QJB5104□TNA01	HMK325 BJ104□F-T	100	B X5R*1	0.1 μ	±10, ±20	3.5	200	1.15±0.10	

【Temperature Characteristic B7 : X7R (−55~+125°C)】 2.5mm thickness

New part number	Old part number (for reference)	Rated voltage [V]	Temperature characteristics	Capacitance [F]	Capacitance tolerance [%]	tan δ [%]	HTLT	Thickness*3 [mm]	Note
							Rated voltage x %		
MLASH32MSB7225□PNA01	HMK325 B7225□M-P	100	X7R	2.2 μ	±10, ±20	3.5	200	2.5±0.20	

▶ This catalog contains the typical specification only due to the limitation of space. When you consider the purchase of our products, please check our specification.  
For details of each product (characteristics graph, reliability information, precautions for use, and so on), see our Web site (<http://www.ty-top.com/>).

## PARTS NUMBER

## 【Temperature Characteristic B7 : X7R (−55~+125°C)】 1.9mm thickness

New part number	Old part number (for reference)	Rated voltage [V]	Temperature characteristics	Capacitance [F]	Capacitance tolerance [%]	tan δ [%]	HTLT	Thickness*3 [mm]	Note
							Rated voltage x %		
MLASH32NSB7154□TNA01	HMK325 B7154□N-T	100	X7R	0.15 μ	±10, ±20	3.5	200	1.9±0.20	
MLASH32NSB7224□TNA01	HMK325 B7224□N-T	100	X7R	0.22 μ	±10, ±20	3.5	200	1.9±0.20	
MLASH32NSB7334□TNA01	HMK325 B7334□N-T	100	X7R	0.33 μ	±10, ±20	3.5	200	1.9±0.20	
MLASH32NSB7474□TNA01	HMK325 B7474□N-T	100	X7R	0.47 μ	±10, ±20	3.5	200	1.9±0.20	
MLASH32NSB7684□TNA01	HMK325 B7684□N-T	100	X7R	0.68 μ	±10, ±20	3.5	200	1.9±0.20	
MLASH32NSB7105□TNA01	HMK325 B7105□N-T	100	X7R	1 μ	±10, ±20	3.5	200	1.9±0.20	
MLASQ32NSB7473□TNA01	QMK325 B7473□N-T	250	X7R	0.047 μ	±10, ±20	2.5	150	1.9±0.20	
MLASQ32NSB7104□TNA01	QMK325 B7104□N-T	250	X7R	0.1 μ	±10, ±20	2.5	150	1.9±0.20	
MLASQ32NSB7154□TNA01	QMK325 B7154□N-T	250	X7R	0.15 μ	±10, ±20	2.5	150	1.9±0.20	
MLASQ32NSB7224□TNA01	QMK325 B7224□N-T	250	X7R	0.22 μ	±10, ±20	2.5	150	1.9±0.20	
MLASS32NSB7223□TNA01	SMK325 B7223□N-T	630	X7R	0.022 μ	±10, ±20	2.5	120	1.9±0.20	
MLASS32NSB7333□TNA01	SMK325 B7333□N-T	630	X7R	0.033 μ	±10, ±20	2.5	120	1.9±0.20	
MLASS32NSB7473□TNA01	SMK325 B7473□N-T	630	X7R	0.047 μ	±10, ±20	2.5	120	1.9±0.20	

## 【Temperature Characteristic C7 : X7S (−55~+125°C)】 2.5mm thickness

New part number	Old part number (for reference)	Rated voltage [V]	Temperature characteristics	Capacitance [F]	Capacitance tolerance [%]	tan δ [%]	HTLT	Thickness*3 [mm]	Note
							Rated voltage x %		
MLASH32MSC7475□PCA01	HMK325 C7475□M-PE	100	X7S	4.7 μ	±10, ±20	3.5	150	2.5±0.20	

## 【Temperature Characteristic B7 : X7R (−55~+125°C)】 1.15mm thickness

New part number	Old part number (for reference)	Rated voltage [V]	Temperature characteristics	Capacitance [F]	Capacitance tolerance [%]	tan δ [%]	HTLT	Thickness*3 [mm]	Note
							Rated voltage x %		
MLASH32QJB7104□TNA01	HMK325 B7104□F-T	100	X7R	0.1 μ	±10, ±20	3.5	200	1.15±0.10	

## 4532TYPE

## 【Temperature Characteristic B5(BJ) : B (−25~+85°C)/X5R (−55~+85°C)】 2.5mm thickness

New part number	Old part number (for reference)	Rated voltage [V]	Temperature characteristics	Capacitance [F]	Capacitance tolerance [%]	tan δ [%]	HTLT	Thickness*3 [mm]	Note
							Rated voltage x %		
MLASH45MSB5474□TNA01	HMK432 BJ474□M-T	100	B X5R <sup>+</sup>	0.47 μ	±10, ±20	3.5	200	2.5±0.20	
MLASH45MSB5105□TNA01	HMK432 BJ105□M-T	100	B X5R <sup>+</sup>	1 μ	±10, ±20	3.5	200	2.5±0.20	
MLASH45MSB5155□TNA01	HMK432 BJ155□M-T	100	B X5R <sup>+</sup>	1.5 μ	±10, ±20	3.5	200	2.5±0.20	
MLASH45MSB5225□TNA01	HMK432 BJ225□M-T	100	B X5R <sup>+</sup>	2.2 μ	±10, ±20	3.5	200	2.5±0.20	
MLASQ45MSB5104□TNA01	QMK432 BJ104□M-T	250	B X5R <sup>+</sup>	0.1 μ	±10, ±20	2.5	150	2.5±0.20	
MLASQ45MSB5224□TNA01	QMK432 BJ224□M-T	250	B X5R <sup>+</sup>	0.22 μ	±10, ±20	2.5	150	2.5±0.20	
MLASQ45MSB5334□TNA01	QMK432 BJ334□M-T	250	B X5R <sup>+</sup>	0.33 μ	±10, ±20	2.5	150	2.5±0.20	
MLASQ45MSB5474□TNA01	QMK432 BJ474□M-T	250	B X5R <sup>+</sup>	0.47 μ	±10, ±20	2.5	150	2.5±0.20	
MLASS45MSB5473□TNA01	SMK432 BJ473□M-T	630	B X5R <sup>+</sup>	0.047 μ	±10, ±20	2.5	120	2.5±0.20	
MLASS45MSB5683□TNA01	SMK432 BJ683□M-T	630	B X5R <sup>+</sup>	0.068 μ	±10, ±20	2.5	120	2.5±0.20	
MLASS45MSB5104□TNA01	SMK432 BJ104□M-T	630	B X5R <sup>+</sup>	0.1 μ	±10, ±20	2.5	120	2.5±0.20	

## 【Temperature Characteristic B7 : X7R (−55~+125°C)】 2.5mm thickness

New part number	Old part number (for reference)	Rated voltage [V]	Temperature characteristics	Capacitance [F]	Capacitance tolerance [%]	tan δ [%]	HTLT	Thickness*3 [mm]	Note
							Rated voltage x %		
MLASH45MSB7474□TNA01	HMK432 B7474□M-T	100	X7R	0.47 μ	±10, ±20	3.5	200	2.5±0.20	
MLASH45MSB7105□TNA01	HMK432 B7105□M-T	100	X7R	1 μ	±10, ±20	3.5	200	2.5±0.20	
MLASH45MSB7155□TNA01	HMK432 B7155□M-T	100	X7R	1.5 μ	±10, ±20	3.5	200	2.5±0.20	
MLASH45MSB7225□TNA01	HMK432 B7225□M-T	100	X7R	2.2 μ	±10, ±20	3.5	200	2.5±0.20	
MLASQ45MSB7104□TNA01	QMK432 B7104□M-T	250	X7R	0.1 μ	±10, ±20	2.5	150	2.5±0.20	
MLASQ45MSB7224□TNA01	QMK432 B7224□M-T	250	X7R	0.22 μ	±10, ±20	2.5	150	2.5±0.20	
MLASQ45MSB7334□TNA01	QMK432 B7334□M-T	250	X7R	0.33 μ	±10, ±20	2.5	150	2.5±0.20	
MLASQ45MSB7474□TNA01	QMK432 B7474□M-T	250	X7R	0.47 μ	±10, ±20	2.5	150	2.5±0.20	
MLASS45MSB7473□TNA01	SMK432 B7473□M-T	630	X7R	0.047 μ	±10, ±20	2.5	120	2.5±0.20	
MLASS45MSB7683□TNA01	SMK432 B7683□M-T	630	X7R	0.068 μ	±10, ±20	2.5	120	2.5±0.20	
MLASS45MSB7104□TNA01	SMK432 B7104□M-T	630	X7R	0.1 μ	±10, ±20	2.5	120	2.5±0.20	

## 【Temperature Characteristic B7 : X7R (−55~+125°C)】 2.0mm thickness

New part number	Old part number (for reference)	Rated voltage [V]	Temperature characteristics	Capacitance [F]	Capacitance tolerance [%]	tan δ [%]	HTLT	Thickness*3 [mm]	Note
							Rated voltage x %		
MLASX45YAB7222KTCA01	XMK432 B7222KY-TE	2000	X7R	2200 p	±10	2.5	110	2.0+0/-0.30	
MLASX45YAB7472KTCA01	XMK432 B7472KY-TE	2000	X7R	4700 p	±10	2.5	110	2.0+0/-0.30	



## PARTS NUMBER

**LW Reversal Decoupling Low ESL Capacitors (LWDC™) for Medical Devices classified as GHTF Classes A or B (Japan Classes I or II)**

## ● 0510TYPE

【Temperature Characteristic B5(BJ): X5R(-55~+85°C)】 0.3mm thickness

New part number	Old part number (for reference)	Rated voltage [V]	Temperature characteristics	Capacitance [F]	Capacitance tolerance [%]	tan δ [%]	HTLT	Thickness*3 [mm]	Note
							Rated voltage x %		
MLRLT103SB5104MFNA01	TWK105 BJ104MP-F	25	X5R	0.1 μ	±20	5	150	0.3±0.05	
MLRLE103SB5224MFNA01	EWK105 BJ224MP-F	16	X5R	0.22 μ	±20	10	150	0.3±0.05	
MLRLL103SB5474MFNA01	LWK105 BJ474MP-F	10	X5R	0.47 μ	±20	10	150	0.3±0.05	
MLRLJ103SB5104MFNA01	JWK105 BJ104MP-F	6.3	X5R <sup>*1</sup>	0.1 μ	±20	5	150	0.3±0.05	
MLRLJ103SB5474MFNA01	JWK105 BJ474MP-F	6.3	X5R <sup>*1</sup>	0.47 μ	±20	10	150	0.3±0.05	
MLRLJ103SB5105MFNA01	JWK105 BJ105MP-F	6.3	X5R	1 μ	±20	10	150	0.3±0.05	
MLRLJ103SB5225MFNA01	JWK105 BJ225MP-F	6.3	X5R	2.2 μ	±20	10	150	0.3±0.05	

【Temperature Characteristic C6 : X6S(-55~+105°C), C7 : X7S(-55~+125°C)】 0.3mm thickness

New part number	Old part number (for reference)	Rated voltage [V]	Temperature characteristics	Capacitance [F]	Capacitance tolerance [%]	tan δ [%]	HTLT	Thickness*3 [mm]	Note
							Rated voltage x %		
MLRLE103SC6104MFNA01	EWK105 C6104MP-F	16	X6S	0.1 μ	±20	5	150	0.3±0.05	
MLRLL103SC7104MFNA01	LWK105 C7104MP-F	10	X7S	0.1 μ	±20	5	150	0.3±0.05	
MLRLL103SC6224MFNA01	LWK105 C6224MP-F	10	X6S	0.22 μ	±20	10	150	0.3±0.05	
MLRLJ103SC7104MFNA01	JWK105 C7104MP-F	6.3	X7S	0.1 μ	±20	5	150	0.3±0.05	
MLRLJ103SC7224MFNA01	JWK105 C7224MP-F	6.3	X7S	0.22 μ	±20	10	150	0.3±0.05	
MLRLJ103SC6474MFNA01	JWK105 C6474MP-F	6.3	X6S	0.47 μ	±20	10	150	0.3±0.05	
MLRLA103SC6224MFNA01	AWK105 C6224MP-F	4	X6S	0.22 μ	±20	10	150	0.3±0.05	
MLRLA103SC6474MFNA01	AWK105 C6474MP-F	4	X6S	0.47 μ	±20	10	150	0.3±0.05	
MLRLA103SC6105MFNA01	AWK105 C6105MP-F	4	X6S	1 μ	±20	10	150	0.3±0.05	
MLRLA103SC6225MFNA01	AWK105 C6225MP-F	4	X6S	2.2 μ	±20	10	150	0.3±0.05	

## ● 0816TYPE

【Temperature Characteristic B5(BJ): X5R(-55~+85°C)】 0.5mm thickness

New part number	Old part number (for reference)	Rated voltage [V]	Temperature characteristics	Capacitance [F]	Capacitance tolerance [%]	tan δ [%]	HTLT	Thickness*3 [mm]	Note
							Rated voltage x %		
MLRLT165SB5104MTNA01	TWK107 BJ104MV-T	25	X5R <sup>*1</sup>	0.1 μ	±20	5	150	0.5±0.05	
MLRLE165SB5224MTNA01	EWK107 BJ224MV-T	16	X5R <sup>*1</sup>	0.22 μ	±20	5	150	0.5±0.05	
MLRLE165SB5474MTNA01	EWK107 BJ474MV-T	16	X5R <sup>*1</sup>	0.47 μ	±20	5	150	0.5±0.05	
MLRLL165SB5105MTNA01	LWK107 BJ105MV-T	10	X5R	1 μ	±20	10	150	0.5±0.05	
MLRLL165SB5225MTNA01	LWK107 BJ225MV-T	10	X5R	2.2 μ	±20	10	150	0.5±0.05	
MLRLJ165SB5105MTNA01	JWK107 BJ105MV-T	6.3	X5R <sup>*1</sup>	1 μ	±20	10	150	0.5±0.05	
MLRLJ165SB5225MTNA01	JWK107 BJ225MV-T	6.3	X5R	2.2 μ	±20	10	150	0.5±0.05	
MLRLJ165SB5475MTNA01	JWK107 BJ475MV-T	6.3	X5R	4.7 μ	±20	10	150	0.5±0.05	
MLRLA165SB5106MTNA01	AWK107 BJ106MV-T	4	X5R	10 μ	±20	10	150	0.5±0.05	

【Temperature Characteristic B7 : X7R(-55~+125°C), C6 : X6S(-55~+105°C), C7 : X7S(-55~+125°C)】 0.5mm thickness

New part number	Old part number (for reference)	Rated voltage [V]	Temperature characteristics	Capacitance [F]	Capacitance tolerance [%]	tan δ [%]	HTLT	Thickness*3 [mm]	Note
							Rated voltage x %		
MLRLT165SB7104MTNA01	TWK107 B7104MV-T	25	X7R	0.1 μ	±20	5	150	0.5±0.05	
MLRLE165SB7224MTNA01	EWK107 B7224MV-T	16	X7R	0.22 μ	±20	5	150	0.5±0.05	
MLRLE165SB7474MTNA01	EWK107 B7474MV-T	16	X7R	0.47 μ	±20	5	150	0.5±0.05	
MLRLJ165SC7105MTNA01	JWK107 C7105MV-T	6.3	X7S	1 μ	±20	10	150	0.5±0.05	
MLRLA165SC7225MTNA01	AWK107 C7225MV-T	4	X7S	2.2 μ	±20	10	150	0.5±0.05	
MLRLA165SC6475MTNA01	AWK107 C6475MV-T	4	X6S	4.7 μ	±20	10	150	0.5±0.05	
MLRLP165SC6106MTNA01	PWK107 C6106MV-T	2.5	X6S	10 μ	±20	10	150	0.5±0.05	

## ● 1220TYPE

【Temperature Characteristic B5(BJ): X5R(-55~+85°C)】 0.85mm thickness

New part number	Old part number (for reference)	Rated voltage [V]	Temperature characteristics	Capacitance [F]	Capacitance tolerance [%]	tan δ [%]	HTLT	Thickness*3 [mm]	Note
							Rated voltage x %		
MLRLT219SB5475□TNA01	TWK212 BJ475□D-T	25	X5R	4.7 μ	±10, ±20	10	150	0.85±0.10	
MLRLE219SB5106MTNA01	EWK212 BJ106MD-T	16	X5R	10 μ	±20	10	150	0.85±0.10	
MLRLL219SB5475□TNA01	LWK212 BJ475□D-T	10	X5R	4.7 μ	±10, ±20	10	150	0.85±0.10	
MLRLL219SB5106MTNA01	LWK212 BJ106MD-T	10	X5R	10 μ	±20	10	150	0.85±0.10	
MLRLJ219SB5226MTNA01	JWK212 BJ226MD-T	6.3	X5R	22 μ	±20	10	150	0.85±0.10	

【Temperature Characteristic B7 : X7R(-55~+125°C), C6 : X6S(-55~+105°C)】 0.85mm thickness

New part number	Old part number (for reference)	Rated voltage [V]	Temperature characteristics	Capacitance [F]	Capacitance tolerance [%]	tan δ [%]	HTLT	Thickness*3 [mm]	Note
							Rated voltage x %		
MLRLT219SB7225□TNA01	TWK212 B7225□D-T	25	X7R	2.2 μ	±10, ±20	5	150	0.85±0.10	
MLRLE219SC6475□TNA01	EWK212 C6475□D-T	16	X6S	4.7 μ	±10, ±20	10	150	0.85±0.10	
MLRLL219SC6106MTNA01	LWK212 C6106MD-T	10	X6S	10 μ	±20	10	150	0.85±0.10	
MLRLA219SC6226MTNA01	AWK212 C6226MD-T	4	X6S	22 μ	±20	10	150	0.85±0.10	

# Multilayer Ceramic Capacitors

## ■ PACKAGING

### ① Minimum Quantity

#### ● Taped package

Type			Thickness		Standard Quantity [pcs]	
Code	JIS(mm)	EIA(inch)	[mm]	Code	Paper tape	Embossed tape
02	0201	008004	0.125	1	—	50000
04	0402	01005	0.2	2	—	40000
06	0603	0201	0.3	3	15000	—
1L	1005	0402	0.13	H	—	20000
			0.18	E	—	15000
			0.2	2	20000	—
			0.3	3	15000	—
10	1005	0402	0.5	5	10000	—
	0510 ※	0204	0.3	3	10000	—
16	1608	0603	0.45	K	4000	—
			0.7	7		
			0.8	8		
			0.8	8	3000 (Soft Termination)	3000 (Soft Termination)
	0816 ※	0306	0.5	5	—	4000
21	2012	0805	0.85	9	4000	—
			1.25	G	—	3000
			1.25	G	—	2000 (Soft Termination)
	1220 ※	0508	0.85	9	4000	—
31	3216	1206	0.85	9	4000	—
			1.15	Q	—	3000
			1.6	L	—	2000
32	3225	1210	0.85	9	—	2000
			1.15	Q		
			1.9	N		
			2.0 max	Y		
			2.5	M	—	500(T), 1000(P)
45	4532	1812	2.0 max	Y	—	1000
			2.5	M	—	500

注: ※LW Reverse type (MSRL, MCRL, MBRL, MLRL, MMRL)

## ② Taping material

※No bottom tape for pressed carrier tape

- Card board carrier tape
- Embossed tape

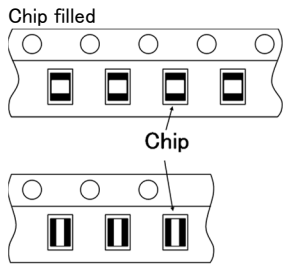
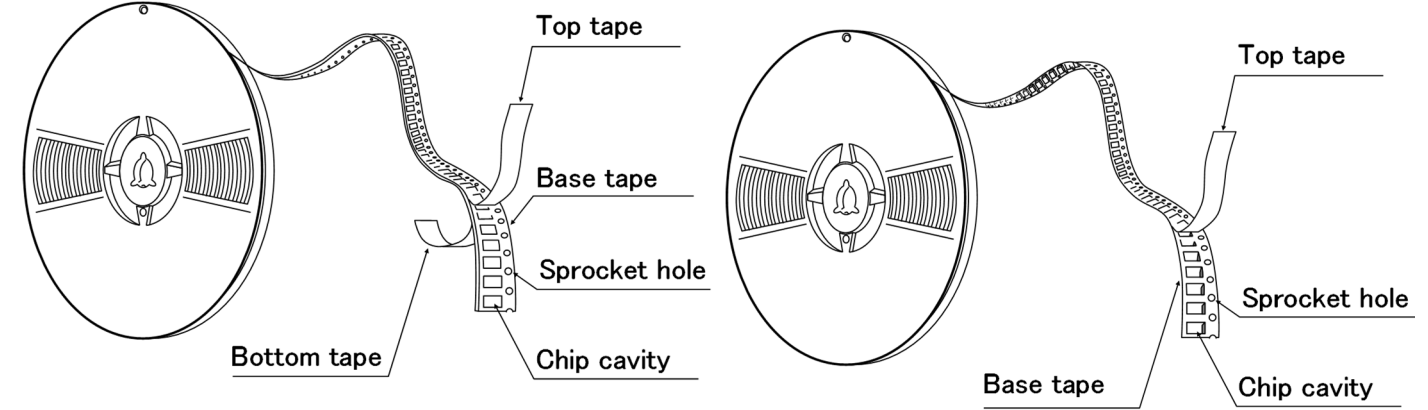

※ LW Reverse type.

## ③ Representative taping dimensions

● Paper Tape (8mm wide)

● Pressed carrier tape ( 2mm pitch)

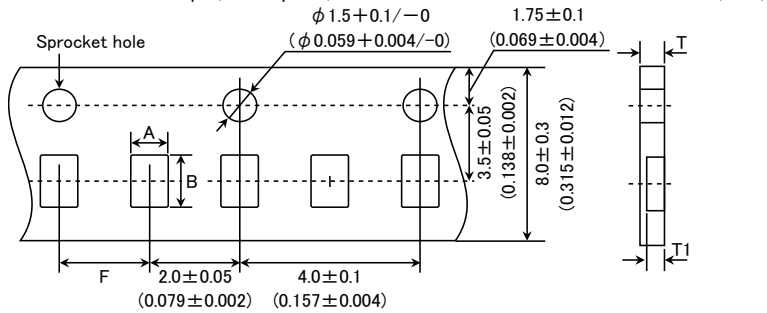

Type(EIA)	Chip Cavity		Insertion Pitch F	Tape Thickness	
	A	B		T	T1
0603 (0201)	0.37	0.67	2.0±0.05	0.45max.	0.42max.
0510 (0204) ※	0.65	1.15		0.4max.	0.3max.
1005 (0402) (*1 2)				0.45max.	0.42max.
1005 (0402) (*1 3)					

Note \*1 Thickness, 2:0.2mm, 3:0.3mm. ※ LW Reverse type.

Unit: mm

● Punched carrier tape (2mm pitch)

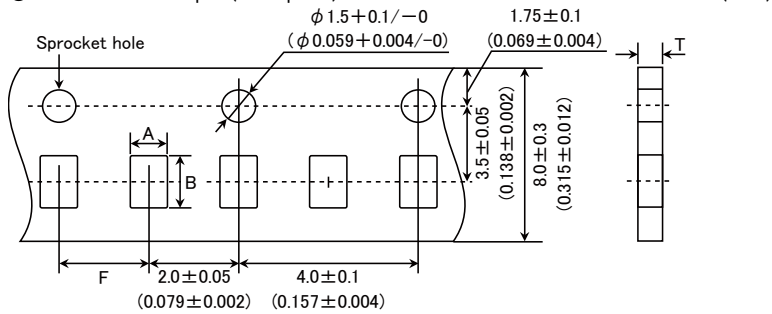

Type(EIA)	Chip Cavity		Insertion Pitch F	Tape Thickness
	A	B		T
1005 (0402)	0.65	1.15	2.0±0.05	0.8max.

Unit: mm

▶ This catalog contains the typical specification only due to the limitation of space. When you consider the purchase of our products, please check our specification. For details of each product (characteristics graph, reliability information, precautions for use, and so on), see our Web site (<http://www.ty-top.com/>).



● Punched carrier tape (4mm pitch)

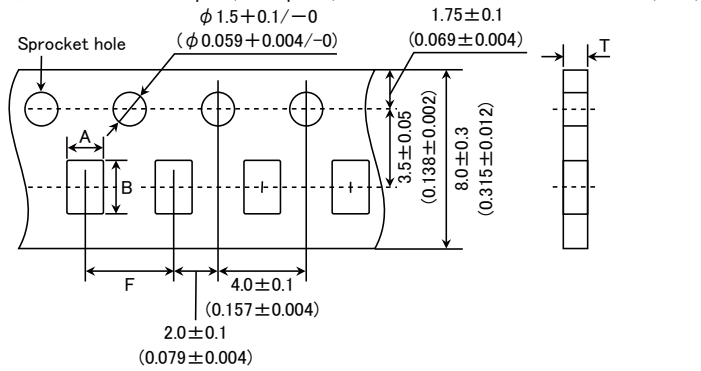

Type(EIA)	Chip Cavity		Insertion Pitch F	Tape Thickness	
	A	B		K	T
1608 (0603)	1.0	1.8	4.0 ± 0.1	1.1max.	1.1max.
0816 (0306) ※					
2012 (0805)					
1220 (0508) ※	1.65	2.4	4.0 ± 0.1	1.1max.	1.1max.
3216 (1206)	2.0	3.6			

Note: Taping size might be different depending on the size of the product. ※ LW Reverse type.

Unit: mm

● Embossed tape (4mm wide)

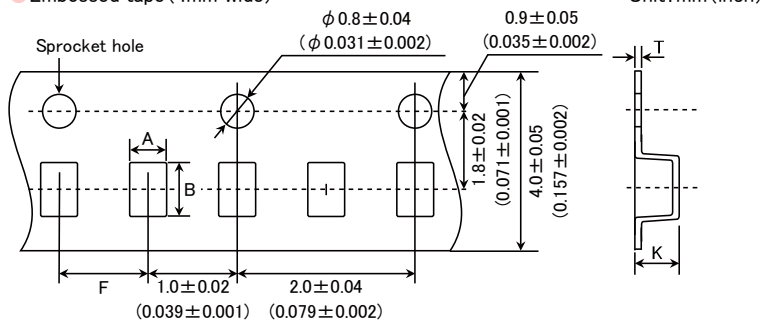

Type(EIA)	Chip Cavity		Insertion Pitch F	Tape Thickness	
	A	B		K	T
0201 (008004)	0.135	0.27	1.0 ± 0.02	0.5max.	0.25max.
0402 (01005)	0.23	0.43			

Unit: mm

● Embossed tape (8mm wide)

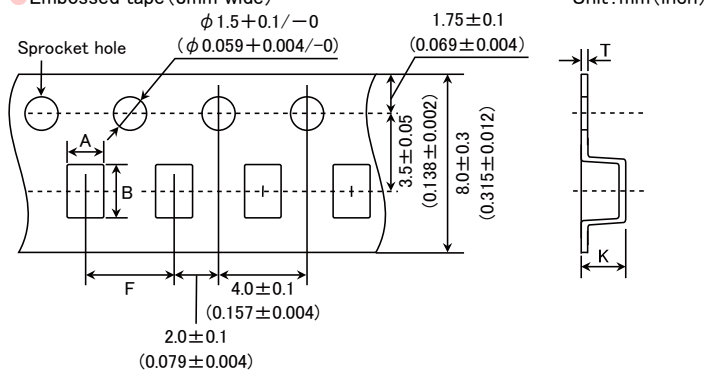

Type(EIA)	Chip Cavity		Insertion Pitch F	Tape Thickness	
	A	B		K	T
1005 (0402)	0.6	1.1	2.0 ± 0.1	0.6max	0.2 ± 0.1
0816 (0306) ※	1.0	1.8	4.0 ± 0.1	1.3max.	0.25 ± 0.1
2012 (0805)	1.65	2.4			
3216 (1206)	2.0	3.6			
3225 (1210)	2.8	3.6	4.0 ± 0.1	3.4max.	0.6max.

Note: ※ LW Reverse type.

Unit: mm

► This catalog contains the typical specification only due to the limitation of space. When you consider the purchase of our products, please check our specification. For details of each product (characteristics graph, reliability information, precautions for use, and so on), see our Web site (<http://www.ty-top.com/>).

● Embossed tape (12mm wide) Unit: mm (inch)

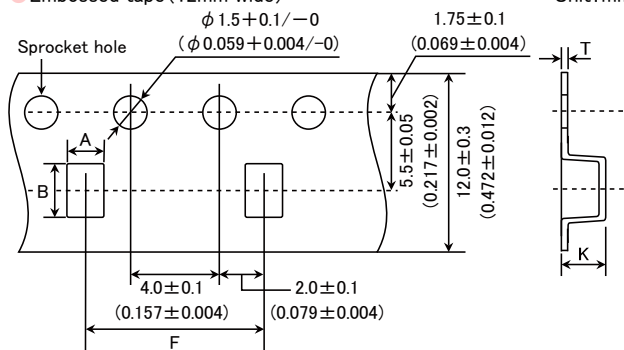

Type(EIA)	Chip Cavity		Insertion Pitch	Tape Thickness	
	A	B		K	T
3225 (1210)	3.1	4.0	8.0 ± 0.1	4.0max.	0.6max.
4532 (1812)	3.7	4.9	8.0 ± 0.1	4.0max.	0.6max.

Unit: mm

④ Trailer and Leader

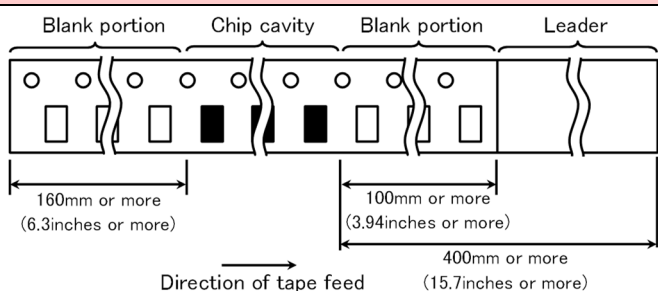

⑤ Reel size

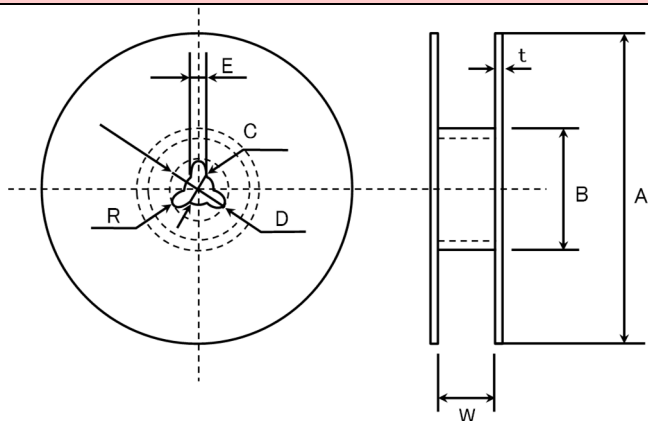

A	B	C	D	E	R
$\phi 178 \pm 2.0$	$\phi 50 \text{min.}$	$\phi 13.0 \pm 0.2$	$\phi 21.0 \pm 0.8$	$2.0 \pm 0.5$	1.0

	T	W
4mm wide tape	1.5max.	$5 \pm 1.0$
8mm wide tape	2.5max.	$10 \pm 1.5$
12mm wide tape	2.5max.	$14 \pm 1.5$

Unit: mm

⑥ Top Tape Strength

The top tape requires a peel-off force of 0.1 to 0.7N in the direction of the arrow as illustrated below.

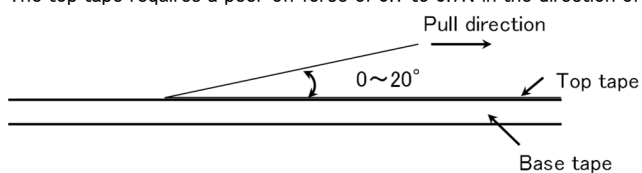

▶ This catalog contains the typical specification only due to the limitation of space. When you consider the purchase of our products, please check our specification. For details of each product (characteristics graph, reliability information, precautions for use, and so on), see our Web site (<http://www.ty-top.com/>).

**Multilayer Ceramic Capacitors for General Electronic Equipment for Consumer**  
**Multilayer Ceramic Capacitors**  
**for Medical Devices classified as GHTF Classes A or B (Japan Classes I or II)**

■ RELIABILITY DATA

1. Operating Temperature Range

Specified Value	Temperature Compensating (Class1)	Standard	-55 to +125°C	
		High Frequency Type		
High Permittivity (Class2)			Specification	Temperature Range
		B5	B	-25 to +85°C
			X5R	-55 to +85°C
		B7	X7R	-55 to +125°C
		C6	X6S	-55 to +105°C
	C7	X7S	-55 to +125°C	

2. Storage Conditions

Specified Value	Temperature Compensating (Class1)	Standard	-55 to +125°C	
		High Frequency Type		
High Permittivity (Class2)			Specification	Temperature Range
		B5	B	-25 to +85°C
			X5R	-55 to +85°C
		B7	X7R	-55 to +125°C
		C6	X6S	-55 to +105°C
	C7	X7S	-55 to +125°C	

3. Rated Voltage

Specified Value	Temperature Compensating (Class1)	Standard	50VDC, 25VDC, 16VDC
		High Frequency Type	25VDC, 16VDC
	High Permittivity (Class2)		50VDC, 35VDC, 25VDC, 16VDC, 10VDC, 6.3VDC, 4VDC, 2.5VDC

4. Withstanding Voltage (Between terminals)

Specified Value	Temperature Compensating (Class1)	Standard	No breakdown or damage
		High Frequency Type	
	High Permittivity (Class2)		
Test Methods and Remarks		Class 1	Class 2
	Applied voltage	Rated voltage × 3	Rated voltage × 2.5
	Duration	1 to 5 sec.	
	Charge/discharge current	50mA max.	

5. Insulation Resistance

Specified Value	Temperature Compensating (Class1)	Standard	10000 MΩ min.
		High Frequency Type	
	High Permittivity (Class2)	Note 1	$C \leq 0.047 \mu F$ : 10000 MΩ min. $C > 0.047 \mu F$ : $500 M\Omega \cdot \mu F$ (C: Nominal capacitance)
Test Methods and Remarks	Applied voltage	: Rated voltage	
	Duration	: 60±5 sec.	
	Charge/discharge current	: 50mA max.	

► This catalog contains the typical specification only due to the limitation of space. When you consider the purchase of our products, please check our specification.  
 For details of each product (characteristics graph, reliability information, precautions for use, and so on), see our Web site (<http://www.ty-top.com/>).

**6. Capacitance (Tolerance)**

Specified Value	Temperature Compensating (Class1)	Standard	$0.2\text{pF} \leq C \leq 5\text{pF} : \pm 0.25\text{pF}$ $5\text{pF} \leq C \leq 10\text{pF} : \pm 0.5\text{pF}$ $C > 10\text{pF} : \pm 5\%$	
		High Frequency Type	Refer to detailed specification	
	High Permittivity (Class2)		$\pm 10\%$ or $\pm 20\%$	
Test Methods and Remarks		Class 1		Class 2
		Standard	High Frequency Type	$C \leq 10 \mu\text{F}$ $C > 10 \mu\text{F}$
	Preconditioning	None		Thermal treatment (at 150°C for 1hr) Note 2
	Measuring frequency	1MHz $\pm 10\%$	1GHz	$1\text{kHz} \pm 10\%$ $120 \pm 10\text{Hz}$
	Measuring voltage Note 1	0.5 to 5Vrms		$1 \pm 0.2\text{Vrms}$ $0.5 \pm 0.1\text{Vrms}$
	Bias application	None		

**7. Q or Dissipation Factor**

Specified Value	Temperature Compensating (Class1)	Standard	$C < 30\text{pF} : Q \geq 400 + 20C$ $C \geq 30\text{pF} : Q \geq 1000$ (C: Nominal capacitance)	
		High Frequency Type	Refer to detailed specification	
	High Permittivity (Class2) Note 1		2.5% max.	
Test Methods and Remarks		Class 1		Class 2
		Standard	High Frequency Type	$C \leq 10 \mu\text{F}$ $C > 10 \mu\text{F}$
	Preconditioning	None		Thermal treatment (at 150°C for 1hr) Note 2
	Measuring frequency	1MHz $\pm 10\%$	1GHz	$1\text{kHz} \pm 10\%$ $120 \pm 10\text{Hz}$
	Measuring voltage Note 1	0.5 to 5Vrms		$1 \pm 0.2\text{Vrms}$ $0.5 \pm 0.1\text{Vrms}$
	Bias application	None		

**8. Temperature Characteristic (Without voltage application)**

Specified Value	Temperature Compensating (Class1)	Standard	Temperature Characteristic [ppm/°C]		Tolerance [ppm/°C]		
			$C \square : 0$	CG(C0G) CH(C0H) CJ(C0J) CK(C0K)	G: $\pm 30$ H: $\pm 60$ J: $\pm 120$ H: $\pm 250$		
	High Frequency Type	Temperature Characteristic [ppm/°C]		Tolerance [ppm/°C]			
			$C \square : 0$	CG(C0G) CH(C0H)	G: $\pm 30$ H: $\pm 60$		
	High Permittivity (Class2)		Specification	Capacitance change	Reference temperature	Temperature Range	
			B5	B X5R	$\pm 10\%$ $\pm 15\%$	20°C 25°C	-25 to +85°C -55 to +85°C
			B7	X7R	$\pm 15\%$	25°C	-55 to +125°C
			C6	XS	$\pm 22\%$	25°C	-55 to +105°C
			C7	X7S	$\pm 22\%$	25°C	-55 to +125°C

Test Methods and Remarks	Class 1 Capacitance at 20°C and 85°C shall be measured in thermal equilibrium, and the temperature characteristic shall be calculated from the following equation.																
	$\frac{(C_{85} - C_{20})}{C_{20} \times \Delta T} \times 10^6 (\text{ppm}/^\circ\text{C}) \quad \Delta T = 65$																
	Class 2 Capacitance at each step shall be measured in thermal equilibrium, and the temperature characteristic shall be calculated from the following equation.																
	<table border="1"> <thead> <tr> <th>Step</th> <th>B</th> <th>X5R, X7R, X6S, X7S</th> </tr> </thead> <tbody> <tr> <td>1</td> <td colspan="2">Minimum operating temperature</td> </tr> <tr> <td>2</td> <td>20°C</td> <td>25°C</td> </tr> <tr> <td>3</td> <td colspan="2">Maximum operating temperature</td> </tr> </tbody> </table>					Step	B	X5R, X7R, X6S, X7S	1	Minimum operating temperature		2	20°C	25°C	3	Maximum operating temperature	
	Step	B	X5R, X7R, X6S, X7S														
1	Minimum operating temperature																
2	20°C	25°C															
3	Maximum operating temperature																
$\frac{(C - C_2)}{C_2} \times 100 (\%) \quad C : \text{Capacitance in Step 1 or Step 3}$ $C_2 : \text{Capacitance in Step 2}$																	
※Measuring frequency and voltage: Refer to detailed specification																	

► This catalog contains the typical specification only due to the limitation of space. When you consider the purchase of our products, please check our specification. For details of each product (characteristics graph, reliability information, precautions for use, and so on), see our Web site (<http://www.ty-top.com/>).

## 9. Deflection

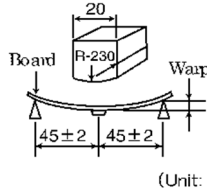
Specified Value	Temperature Compensating (Class1)	Standard	Appearance : No abnormality Capacitance change : Within $\pm 5\%$ or $\pm 0.5$ pF, whichever is larger.	
		High Frequency Type	Appearance : No abnormality Capacitance change : Within $\pm 0.5$ pF	
	High Permittivity (Class2)		Appearance : No abnormality Capacitance change : Within $\pm 12.5\%$	
Test Methods and Remarks	Multilayer Ceramic Capacitors		 <p style="font-size: small;">(Unit: mm) Capacitance measurement shall be conducted with the board bent</p>	
		0201, 0402, 0603, ※1005 Type		The other types
	Board	Glass epoxy-resin substrate		
	Thickness	0.8mm		1.6mm
	Warp	1mm		
	Duration	10 sec.		
	※1005 Type thickness, 2: 0.2mm, 3: 0.3mm.			

## 10. Adhesive Strength of Terminal Electrodes

Specified Value	Temperature Compensating (Class1)	Standard	No terminal separation or its indication.	
		High Frequency Type		
	High Permittivity (Class2)			
Test Methods and Remarks		0201Type	0402, 0603Type	1005Type or more
	Applied force	1N	2N	5N
	Duration	10 ± 1 sec		30 ± 5 sec

## 11. Vibration

Specified Value	Temperature Compensating (Class1)	Standard	Initial performance shall be satisfied.
		High Frequency Type	
	High Permittivity (Class2)		
Test Methods and Remarks	Preconditioning	: Thermal treatment (at 150°C for 1hr) Note2 (Only High permittivity)	
	Frequency range	: 10 to 55 Hz	
	Overall amplitude	: 1.5 mm	
	Sweeping method	: 10 to 55 to 10 Hz for 1 min Two hours each in X, Y, Z directions: 6 hrs in total	

## 12. Solderability

Specified Value	Temperature Compensating (Class1)	Standard	At least 95% of terminal electrode is covered by new solder.
		High Frequency Type	
	High Permittivity (Class2)		
Test Methods and Remarks		Eutectic solder	Lead-free solder
	Solder type	H60A or H63A	Sn-3.0Ag-0.5Cu
	Solder temperature	230 ± 5°C	
	Duration	4 ± 1 sec.	

### 13. Resistance to Soldering

Specified Value	Temperature Compensating (Class1)	Standard	Appearance : No abnormality Capacitance change : Within $\pm 2.5\%$ or $\pm 0.25\text{pF}$ , whichever is larger. Q : Initial value Insulation resistance : Initial value Withstanding voltage (between terminals) : No abnormality	
		High Frequency Type	Appearance : No abnormality Capacitance change : Within $\pm 2.5\%$ or $\pm 0.25\text{pF}$ , whichever is larger. Q : Initial value Insulation resistance : Initial value Withstanding voltage (between terminals) : No abnormality	
	High Permittivity (Class2) Note 1		Appearance : No abnormality Capacitance change : Within $\pm 7.5\%$ Dissipation factor : Initial value Insulation resistance : Initial value Withstanding voltage (between terminals) : No abnormality	
Test Methods and Remarks	Class 1			
		0201, 0402, 0603 Type	1005 Type	
	Preconditioning	None		
	Preheating	150°C, 1 to 2 min.	80 to 100°C, 2 to 5 min. 150 to 200°C, 2 to 5 min.	
	Solder temp.	270 $\pm$ 5°C		
	Duration	3 $\pm$ 0.5 sec.		
	Recovery	24 $\pm$ 2 hrs (Standard condition) Note 5		
	Class 2			
		0201, 0402, 0603 Type	1005, 1608, 2012 Type	3216, 3225, 4532 Type
	Preconditioning	Thermal treatment (at 150°C for 1 hr) Note 2		
	Preheating	150°C, 1 to 2 min.	80 to 100°C, 2 to 5 min. 150 to 200°C, 2 to 5 min.	80 to 100°C, 5 to 10 min. 150 to 200°C, 5 to 10 min.
	Solder temp.	270 $\pm$ 5°C		
	Duration	3 $\pm$ 0.5 sec.		
	Recovery	24 $\pm$ 2 hrs (Standard condition) Note 5		

### 14. Temperature Cycle (Thermal Shock)

Specified Value	Temperature Compensating (Class1)	Standard	Appearance : No abnormality Capacitance change : Within $\pm 2.5\%$ or $\pm 0.25\text{pF}$ , whichever is larger. Q : Initial value Insulation resistance : Initial value Withstanding voltage (between terminals) : No abnormality	
		High Frequency Type	Appearance : No abnormality Capacitance change : Within $\pm 2.5\%$ or $\pm 0.25\text{pF}$ , whichever is larger. Q : Initial value Insulation resistance : Initial value Withstanding voltage (between terminals) : No abnormality	
	High Permittivity (Class2) Note 1		Appearance : No abnormality Capacitance change : Within $\pm 7.5\%$ Dissipation factor : Initial value Insulation resistance : Initial value Withstanding voltage (between terminals) : No abnormality	
Test Methods and Remarks	Class 1		Class 2	
	Preconditioning	None	Thermal treatment (at 150°C for 1 hr) Note 2	
	1 cycle	Step	Temperature (°C)	Time (min.)
		1	Minimum operating temperature	30 $\pm$ 3
		2	Normal temperature	2 to 3
		3	Maximum operating temperature	30 $\pm$ 3
4	Normal temperature	2 to 3		
Number of cycles	5 times			
Recovery	24 $\pm$ 2 hrs (Standard condition) Note 5			

► This catalog contains the typical specification only due to the limitation of space. When you consider the purchase of our products, please check our specification. For details of each product (characteristics graph, reliability information, precautions for use, and so on), see our Web site (<http://www.ty-top.com/>).

15. Humidity (Steady State)			
Specified Value	Temperature Compensating (Class1)	Standard	Appearance : No abnormality Capacitance change : Within $\pm 5\%$ or $\pm 0.5\text{pF}$ , whichever is larger. Q : $C < 10\text{pF} : Q \geq 200 + 10C$ $10 \leq C < 30\text{pF} : Q \geq 275 + 2.5C$ $C \geq 30\text{pF} : Q \geq 350$ (C: Nominal capacitance) Insulation resistance : $1000 \text{ M}\Omega$ min.
		High Frequency Type	Appearance : No abnormality Capacitance change : Within $\pm 5\%$ or $\pm 0.5\text{pF}$ , whichever is larger. Insulation resistance : $1000 \text{ M}\Omega$ min.
	High Permittivity (Class2) Note 1		Appearance : No abnormality Capacitance change : Within $\pm 12.5\%$ Dissipation factor : 5.0% max. Insulation resistance : $50 \text{ M}\Omega \mu\text{F}$ or $1000 \text{ M}\Omega$ whichever is smaller.
Test Methods and Remarks	Preconditioning : Thermal treatment (at $150^\circ\text{C}$ for 1hr) Note2 (Only High permittivity) Temperature : $40 \pm 2^\circ\text{C}$ Humidity : 90 to 95%RH Duration : 500 +24/−0 hrs Recovery : $24 \pm 2$ hrs under the standard condition Note 1,5		

16. Humidity Loading			
Specified Value	Temperature Compensating (Class1)	Standard	Appearance : No abnormality Capacitance change : Within $\pm 7.5\%$ or $\pm 0.75\text{pF}$ , whichever is larger. Q : $C < 30\text{pF} : Q \geq 100 + 10C/3$ $C \geq 30\text{pF} : Q \geq 200$ (C: Nominal capacitance) Insulation resistance : $500 \text{ M}\Omega$ min.
		High Frequency Type	Appearance : No abnormality Capacitance change : $C \leq 2\text{pF} : \text{Within } \pm 0.4 \text{ pF}$ $C > 2\text{pF} : \text{Within } \pm 0.75 \text{ pF}$ $C > 10\text{pF} : \text{Within } \pm 0.75\%$ (C: Nominal capacitance) Insulation resistance : $500 \text{ M}\Omega$ min.
	High Permittivity (Class2) Note 1		Appearance : No abnormality Capacitance change : Within $\pm 12.5\%$ Dissipation factor : 5.0% max. Insulation resistance : $25 \text{ M}\Omega \mu\text{F}$ or $500 \text{ M}\Omega$ , whichever is smaller.
Test Methods and Remarks	Preconditioning : Voltage treatment (Rated voltage are applied for 1 hour at $40^\circ\text{C}$ ) Note 1,3 (Only High permittivity) Temperature : $40 \pm 2^\circ\text{C}$ Humidity : 90 to 95%RH Duration : 500 +24/−0 hrs Applied voltage : Rated voltage Charge/discharge current : 50mA max. Recovery : $24 \pm 2$ hrs under the standard condition Note 1,5		

## 17. High Temperature Loading

Specified Value	Temperature Compensating (Class1)	Standard	Appearance : No abnormality Capacitance change : Within $\pm 3\%$ or $\pm 0.3\text{pF}$ , whichever is larger. Q : $C < 10\text{pF}$ : $Q \geq 200 + 10C$ $10 \leq C < 30\text{pF}$ : $Q \geq 275 + 2.5C$ $C \geq 30\text{pF}$ : $Q \geq 350$ (C: Nominal capacitance) Insulation resistance : $1000 \text{ M}\Omega$ min.
		High Frequency Type	Appearance : No abnormality Capacitance change : Within $\pm 3\%$ or $\pm 0.3\text{pF}$ , whichever is larger. Insulation resistance : $1000 \text{ M}\Omega$ min.
	High Permittivity (Class2) Note 1	Appearance : No abnormality Capacitance change : Within $\pm 12.5\%$ Dissipation factor : $5.0\%$ max. Insulation resistance : $50 \text{ M}\Omega \mu\text{F}$ or $1000 \text{ M}\Omega$ , whichever is smaller.	
Test Methods and Remarks	Preconditioning : Voltage treatment (Twice the rated voltage shall be applied for 1 hour at $85^\circ\text{C}$ , $105^\circ\text{C}$ or $125^\circ\text{C}$ ) Note 1,3,4 (Only High permittivity) Temperature : Maximum operating temperature Duration : $1000 +24/-0$ hrs Applied voltage : Rated voltage $\times 2$ Note 4 Charge/discharge current : $50\text{mA}$ max. Recovery : $24 \pm 2$ hrs under the standard condition Note 1,5		

Note 1 The figures indicate typical specifications. Please refer to individual specifications in detail.

Note 2 Thermal treatment : Initial value shall be measured after test sample is heat-treated at  $150 \pm 0/-10^\circ\text{C}$  for an hour and kept at room temperature for  $24 \pm 2$  hours.

Note 3 Voltage treatment : Initial value shall be measured after test sample is voltage-treated for an hour at both the temperature and voltage specified in the test conditions, and kept at room temperature for  $24 \pm 2$  hours.

Note 4 150% of rated voltage is applicable to some items. Please refer to their specifications for further information.

Note 5 Standard condition: Temperature:  $5$  to  $35^\circ\text{C}$ , Relative humidity:  $45$  to  $85\%$  RH, Air pressure:  $86$  to  $106\text{kPa}$  When there are questions concerning measurement results, in order to provide correlation data, the test shall be conducted under the following condition.

Temperature:  $20 \pm 2^\circ\text{C}$ , Relative humidity:  $60$  to  $70\%$  RH, Air pressure:  $86$  to  $106\text{kPa}$  Unless otherwise specified, all the tests are conducted under the "standard condition".



**Low distortion design/Audible/Good bias Multilayer Ceramic Capacitors  
for General Electronic Equipment for Consumer**  
**Low distortion design/Audible/Good bias Multilayer Ceramic Capacitors  
for Medical Devices classified as GHTF Classes A or B (Japan Classes I or II)**

■ RELIABILITY DATA

1. Operating Temperature Range

Specified Value		Specification	Temperature Range
	LD	X5R	-55~+85°C
	SD	-	-55~+125°C

2. Storage Temperature Range

Specified Value		Specification	Temperature Range
	LD	X5R	-55~+85°C
	SD	-	-55~+125°C

3. Rated Voltage

Specified Value	6.3VDC, 10VDC, 16VDC, 25VDC, 35VDC, 50VDC
-----------------	---

4. Dielectric Withstanding Voltage (Between terminals)

Specified Value	No breakdown or damage	
Test Methods and Remarks	Applied voltage	: Rated voltage × 2.5(LD), Rated voltage × 3(SD)
	Duration	: 1 to 5 sec.
	Charge/discharge current	: 50mA max.

5. Insulation Resistance

Specified Value Note 1	10000 MΩ or 500MΩ μF, whichever is smaller	
Test Methods and Remarks	Applied voltage	: Rated voltage
	Duration	: 60±5 sec.
	Charge/discharge current	: 50mA max.

6. Capacitance (Tolerance)

Specified Value	±10% or ±20%	
Test Methods and Remarks	Measuring frequency	: 1kHz±10%
	Measuring voltage	: 1±0.2Vrms
	Bias application	: None

7. Dissipation Factor

Specified Value	10% max (LD), 0.1% max (SD)	
Test Methods and Remarks	Measuring frequency	: 1kHz±10%
	Measuring voltage	: 1±0.2Vrms
	Bias application	: None

► This catalog contains the typical specification only due to the limitation of space. When you consider the purchase of our products, please check our specification.  
 For details of each product (characteristics graph, reliability information, precautions for use, and so on), see our Web site (<http://www.ty-top.com/>).

**8. Temperature Characteristic (Without voltage application)**

Specified Value	Specification		Capacitance change	Reference temperature	Temperature Range
	LD	X5R	± 15%	25°C	-55~+85°C
Test Methods and Remarks	Capacitance at each step shall be measured in thermal equilibrium, and the temperature characteristic shall be calculated from the following equation.				
	Step	X5R			
	1	Minimum operating temperature			
	2	25°C			
	3	Maximum operating temperature			
	$\frac{(C-C_2)}{C_2} \times 100(\%)$			C :Capacitance value in Step1 or Step3 C <sub>2</sub> :Capacitance value in Step2	

**9. Bending Strength**

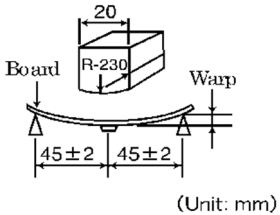
Specified Value	Appearance : No abnormality Capacitance change : Within ± 12.5% (LD), Within ± 5% (SD)
Test Methods and Remarks	Warp : 1mm Speed : 0.5mm/second Duration : 10 seconds Test board : glass epoxy resin substrate Thickness : 1.6mm  <p>(Unit: mm)</p> Capacitance measurement shall be conducted with the board bent.

**10. Adhesive Force of Terminal Electrodes**

Specified Value	Terminal electrodes shall be no exfoliation or a sign of exfoliation.
Test Methods and Remarks	Applied force : 5N Duration : 30 ± 5 seconds

**11. Vibration**

Specified Value	Initial performance shall be satisfied.
Test Methods and Remarks	Preconditioning : Thermal treatment (at 150°C for 1hr) Note2 (Only LD) Frequency range : 10 to 55 Hz Overall amplitude : 1.5 mm Sweeping method : 10 to 55 to 10 Hz for 1 min Two hours each in X, Y, Z directions: 6 hrs in total

**12. Solderability**

Specified Value	At least 95% of terminal electrode is covered by new solder.		
Test Methods and Remarks		Eutectic solder	Lead-free solder
	Solder type	H60A or H63A	Sn-3.0Ag-0.5Cu
	Solder temperature	230 ± 5°C	245 ± 3°C
	Duration	4 ± 1 sec.	

► This catalog contains the typical specification only due to the limitation of space. When you consider the purchase of our products, please check our specification. For details of each product (characteristics graph, reliability information, precautions for use, and so on), see our Web site (<http://www.ty-top.com/>).

### 13. Resistance to Soldering Heat

Specified Value	Appearance	: No abnormality	
	Capacitance change	: Within $\pm 7.5\%$ (LD), Within $\pm 2.5\%$ (SD)	
Specified Value	Dissipation factor	: Initial value	
	Insulation resistance	: Initial value	
Specified Value	Withstanding voltage (between terminals)	: No abnormality	
	Test Methods and Remarks		LD
		1608、2012type	3216、3225type
Preconditioning		Thermal treatment (at 150°C for 1 hr) Note 2	
Preheating conditions		80 to 100°C 2 to 5 min 150 to 200°C 2 to 5 min	80 to 100°C 5 to 10 min 150 to 200°C 5 to 10 min
Solder temp.		270 $\pm$ 5°C	
Duration		3 $\pm$ 0.5 sec.	
Measurement shall be conducted		24 $\pm$ 2hrs under the standard condition Note 5	
		SD	
		1005、1608、2012type	3216type
Preheating conditions		80 to 100°C 2 to 5 min 150 to 200°C 2 to 5 min	80 to 100°C 5 to 10 min 150 to 200°C 5 to 10 min
Solder temp.	270 $\pm$ 5°C		
Duration	3 $\pm$ 0.5 sec.		
Measurement shall be conducted	24 $\pm$ 2hrs under the standard condition Note 5		

### 14. Temperature Cycle (Thermal Shock)

Specified Value	Appearance	: No abnormality		
	Capacitance change	: Within $\pm 7.5\%$ (LD), Within $\pm 2.5\%$ (SD)		
Specified Value	Dissipation factor	: Initial value		
	Insulation resistance	: Initial value		
Specified Value	Withstanding voltage (between terminals)	: No abnormality		
	Test Methods and Remarks		LD	SD
Preconditioning		Thermal treatment (at 150°C for 1 hr) Note 2	None	
1 cycle		Step	temperature (°C)	Time (min.)
		1	Minimum operating temperature	30 $\pm$ 3 min.
		2	Normal temperature	2 to 3 min.
		3	Maximum operating temperature	30 $\pm$ 3 min.
4		Normal temperature	2 to 3 min.	
Number of cycles	5 time			
Measurement shall be conducted	24 $\pm$ 2hrs under the standard condition Note 5			

### 15. Humidity (Steady state)

Specified Value Note 1	Appearance	: No abnormality	
	Capacitance change	: Within $\pm 12.5\%$ (LD), $\pm 5\%$ Within(SD)	
Specified Value	Dissipation factor	: 20%max(LD), 0.5%max(SD)	
	Insulation resistance	: 50M $\Omega$ $\mu$ F or 1000M $\Omega$ , whichever is smaller	
Test Methods and Remarks		LD	SD
	Preconditioning	Thermal treatment (at 150°C for 1 hr) Note 2	None
	Temperature	40 $\pm$ 2°C	
	Humidity	90 to 95% RH	
	Duration	500 +24/-0 hrs	
	Measurement shall be conducted	24 $\pm$ 2hrs under the standard condition Note 5	

▶ This catalog contains the typical specification only due to the limitation of space. When you consider the purchase of our products, please check our specification.  
For details of each product (characteristics graph, reliability information, precautions for use, and so on), see our Web site (<http://www.ty-top.com/>).

**16. Humidity Loading**

Specified Value Note 1	Appearance	: No abnormality	
	Capacitance change	: Within $\pm 12.5\%$ (LD), Within $\pm 7.5\%$ (SD)	
	Dissipation factor	: 20%max (LD), 0.5%max (SD)	
	Insulation resistance	: 25M $\Omega$ $\mu$ F or 500M $\Omega$ , whichever is smaller	
Test Methods and Remarks		LD	SD
	Preconditioning	Voltage treatment (Rated voltage are applied for 1 hour at 40 °C) Note 3	
	Temperature	40 $\pm$ 2°C	
	Humidity	90 to 95% RH	
	Duration	500 +24/−0 hrs	
	Applied voltage	Rated voltage	
	Charge/discharge current	50mA max	
	Measurement shall be conducted	24 $\pm$ 2hrs under the standard condition Note 5	

**17. High Temperature Loading**

Specified Value Note 1	Appearance	: No abnormality	
	Capacitance change	: Within $\pm 12.5\%$ (LD), Within $\pm 3\%$ (SD)	
	Dissipation factor	: 20%max (LD), 0.35%max (SD)	
	Insulation resistance	: 50M $\Omega$ $\mu$ F or 1000M $\Omega$ , whichever is smaller	
Test Methods and Remarks		LD	SD
	Preconditioning	Voltage treatment (Twice the rated voltage shall be applied for 1 hour at 85°C or 125°C) Note 3, Note 4	
	Temperature	Maximum operating temperature	
	Duration	1000 +48/−0 hrs	
	Applied voltage	Rated voltage x 2 Note 4	Rated voltage x 2
	Charge/discharge current	50mA max	
	Measurement shall be conducted	24 $\pm$ 2hrs under the standard condition Note 5	

Note 1 The figures indicate typical specifications. Please refer to individual specifications in detail.

Note 2 Thermal treatment : Initial value shall be measured after test sample is heat-treated at 150+0/−10°C for an hour and kept at room temperature for 24 $\pm$ 2hours.

Note 3 Voltage treatment : Initial value shall be measured after test sample is voltage-treated for an hour at both the temperature and voltage specified in the test conditions, and kept at room temperature for 24 $\pm$ 2hours.

Note 4 150% of rated voltage is applicable to some items. Please refer to their specifications for further information.

Note 5 Standard condition: Temperature: 5 to 35°C, Relative humidity: 45 to 85 % RH, Air pressure: 86 to 106kPa When there are questions concerning measurement results, in order to provide correlation data, the test shall be conducted under the following condition.

Temperature: 20 $\pm$ 2°C, Relative humidity: 60 to 70 % RH, Air pressure: 86 to 106kPa Unless otherwise specified, all the tests are conducted under the "standard condition".

**Medium-High Voltage Multilayer Ceramic Capacitor for General Electronic Equipment for Consumer**  
**Medium-High Voltage Multilayer Ceramic Capacitor**  
**for Medical Devices classified as GHTF Classes A or B (Japan Classes I or II)**

■ RELIABILITY DATA

1. Operating Temperature Range		
Specified Value	Temperature Compensating(Class1)	C0G, C0H : -55 to +125°C
	High Permittivity (Class2)	X7R, X7S : -55 to +125°C X5R : -55 to +85°C B : -25 to +85°C SD : -55 to +125°C
2. Storage Temperature Range		
Specified Value	Temperature Compensating(Class1)	C0G, C0H : -55 to +125°C
	High Permittivity (Class2)	X7R, X7S : -55 to +125°C X5R : -55 to +85°C B : -25 to +85°C SD : -55 to +125°C
3. Rated Voltage		
Specified Value	Temperature Compensating(Class1)	100VDC(Code:H)
	High Permittivity (Class2)	100VDC(Code:H), 250VDC(Code:Q), 630VDC(Code:S), 2000VDC(Code:X)
4. Withstanding Voltage (Between terminals)		
Specified Value	No breakdown or damage	
Test Methods and Remarks	Applied voltage : Rated voltage (H) × 2.5, Rated voltage (Q) × 2, Rated voltage (S, X) × 1.2 Duration : 1 to 5sec. Charge/discharge current : 50mA max.	
5. Insulation Resistance		
Specified Value	Temperature Compensating(Class1)	10000 MΩ min.
	High Permittivity (Class2)	100MΩ · μF or 10GΩ, whichever is smaller.
Test Methods and Remarks	Applied voltage : Rated voltage (H, Q), 500V (S, X) Duration : 60±5sec. Charge/discharge current : 50mA max.	
6. Capacitance (Tolerance)		
Specified Value	Temperature Compensating(Class1)	C ≤ 10pF : ±0.5pF C > 10pF : ±5% (C: Nominal capacitance)
	High Permittivity (Class2)	±10%, ±20%
Test Methods and Remarks	Temperature Compensating(Class1)	Measuring frequency : 1MHz ± 10% Measuring voltage : 0.5~5Vrms Bias application : None
	High Permittivity (Class2)	Measuring frequency : 1kHz ± 10%, 1MHz ± 10% (SD: 1608type(H), 2012type(Q)) Measuring voltage : 1 ± 0.2Vrms Bias application : None

► This catalog contains the typical specification only due to the limitation of space. When you consider the purchase of our products, please check our specification.  
 For details of each product (characteristics graph, reliability information, precautions for use, and so on), see our Web site (<http://www.ty-top.com/>).

### 7. Q or Dissipation Factor

Specified Value	Temperature Compensating(Class1)	C < 30pF : Q ≥ 400 + 20C C ≥ 30pF : Q ≥ 1000 (C: Nominal capacitance)
	High Permittivity (Class2)	3.5%max(H: 1608type min), 2.5%max(H: 1005type,Q, S, X), 0.1type max (SD)
Test Methods and Remarks	Temperature Compensating(Class1)	Measuring frequency : 1MHz ± 10% Measuring voltage : 0.5 ~ 5Vrms Bias application : None
	High Permittivity (Class2)	Measuring frequency : 1kHz ± 10%, 1MHz ± 10% (SD:1608type(H), 2012type(Q)) Measuring voltage : 1 ± 0.2Vrms Bias application : None

### 8. Temperature Characteristic of Capacitance

Specified Value	Temperature Compensating(Class1)	C0G : 0 ± 30ppm/°C (-55 to +125°C) C0H : 0 ± 60ppm/°C (-55 ~ +125°C)											
	High Permittivity (Class2)	B : ± 10% (-25 to +85°C) X5R : ± 15% (-55 to +85°C) X7R : ± 15% (-55 to +125°C) X7S : ± 22% (-55 to +125°C)											
Test Methods and Remarks	<p>Class 1 Capacitance at 20°C and 85°C shall be measured in thermal equilibrium, and the temperature characteristic shall be calculated from the following equation.</p> $\frac{(C_{85} - C_{20})}{C_{20} \times \Delta T} \times 10^6 \text{ (ppm/°C)} \quad \Delta T = 65$												
	<p>Class 2 Capacitance at each step shall be measured in thermal equilibrium, and the temperature characteristic shall be calculated from the following equation.</p> <table border="1"> <thead> <tr> <th>Step</th> <th>B</th> <th>X5R, X7R, X7S</th> </tr> </thead> <tbody> <tr> <td>1</td> <td colspan="2">Minimum operating temperature</td> </tr> <tr> <td>2</td> <td>20°C</td> <td>25°C</td> </tr> <tr> <td>3</td> <td colspan="2">Maximum operating temperature</td> </tr> </tbody> </table> $\frac{(C - C_2)}{C_2} \times 100 \text{ (%)}$ <p>C : Capacitance value in Step 1 or Step 3 C2 : Capacitance value in Step 2</p>		Step	B	X5R, X7R, X7S	1	Minimum operating temperature		2	20°C	25°C	3	Maximum operating temperature
Step	B	X5R, X7R, X7S											
1	Minimum operating temperature												
2	20°C	25°C											
3	Maximum operating temperature												

### 9. Deflection

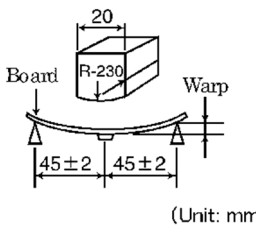
Specified Value	Temperature Compensating(Class1)	Appearance : No abnormality Capacitance change : Within ± 5% or ± 0.5 pF, whichever is larger.
	High Permittivity (Class2)	Appearance : No abnormality Capacitance change : ± 10%, ± 5%, (SD)
Test Methods and Remarks	<p>Warp : 1mm Duration : 10sec. Test board : Glass epoxy-resin substrate Thickness : 1.6mm</p>	 <p>(Unit: mm)</p> <p>Capacitance measurement shall be conducted with the board bent.</p>

### 10. Adhesive Strength of Terminal Electrodes

Specified Value	Temperature Compensating(Class1)	No terminal separation or its indication.
	High Permittivity (Class2)	
Test Methods and Remarks	Applied force : 5N	
	Duration : 30 ± 5sec.	

▶ This catalog contains the typical specification only due to the limitation of space. When you consider the purchase of our products, please check our specification. For details of each product (characteristics graph, reliability information, precautions for use, and so on), see our Web site (<http://www.ty-top.com/>).

11. Vibration			
Specified Value	Temperature Compensating(Class1)	Initial performance shall be satisfied.	
	High Permittivity (Class2)		
Test Methods and Remarks	Preconditioning : Thermal treatment(at 150°C for 1hr) Note1 (Only High permittivity)		
	Frequency range : 10 to 55 Hz		
	Overall amplitude : 1.5 mm		
	Sweeping method : 10 to 55 to 10 Hz for 1 min		
	Two hours each in X, Y, Z directions: 6 hrs in total		
12. Solderability			
Specified Value	Temperature Compensating(Class1)	At least 95% of terminal electrode is covered by new solder	
	High Permittivity (Class2)		
Test Methods and Remarks		Eutectic solder	Lead-free solder
	Solder type	H60A or H63A	Sn-3.0Ag-0.5Cu
	Solder temperature	230±5°C	245±3°C
	Duration	4±1 sec.	
13. Resistance to Soldering			
Specified Value	Temperature Compensating(Class1)	Appearance : No abnormality	
		Capacitance change : Within ±2.5% or ±0.25pF, whichever is larger.	
		Q : Initial value	
		Insulation resistance : Initial value	
		Withstanding voltage (between terminals) : No abnormality	
Specified Value	High Permittivity (Class2)	Appearance : No abnormality	
		Capacitance change : Within±7.5%(H: 1005type), ±15%(H: 1608type min) ±10%(Q, S, X), ±2.5%(SD)	
		Dissipation facto : Initial value	
		Insulation resistance : Initial value	
		Withstanding voltage (between terminals) : No abnormality	
Test Methods and Remarks	Temperature Compensating(Class1)		
	Preconditioning	None	
	Solder temperature	270±5°C	
	Duration	3±0.5sec.	
	Preheating conditions	80 to 100°C, 2 to 5 min. 150 to 200°C, 2 to 5min.	
	Recovery	24±2hrs under the standard condition Note3	
	High Permittivity (Class2)		
	Preconditioning	Thermal treatment(at 150°C for 1hr) Note1	
	Solder temperature	270±5°C	
	Duration	3±0.5sec.	
	Preheating conditions	80 to 100°C, 2 to 5 min.(2012type max), 5 to 10 min(3216type min) 150 to 200°C, 2 to 5min.(2012type max), 5 to 10 min(3216type min)	
	Recovery	24±2hrs under the standard condition Note3	



#### 14. Temperature Cycle (Thermal Shock)

Specified Value	Temperature Compensating(Class1)	Appearance : No abnormality Capacitance change : Within $\pm 2.5\%$ or $\pm 0.25\text{pF}$ , whichever is larger. Q : Initial value Insulation resistance : Initial value Withstanding voltage (between terminals) : No abnormality																							
	High Permittivity (Class2)	Appearance : No abnormality Capacitance change : Within $\pm 7.5\%$ (H: 1005type), $\pm 15\%$ (H: 1608type min) $\pm 10\%$ (Q, S, X), $\pm 2.5\%$ (SD) Dissipation facto : Initial value Insulation resistance : Initial value Withstanding voltage (between terminals) : No abnormality																							
Test Methods and Remarks	<table border="1"> <thead> <tr> <th></th> <th>Class 1</th> <th>Class 2</th> </tr> </thead> <tbody> <tr> <td>Preconditioning</td> <td>None</td> <td>Thermal treatment (at 150°C for 1 hr) Note 1</td> </tr> <tr> <td rowspan="4">1 cycle</td> <td>Step</td> <td>Temperature (°C)</td> </tr> <tr> <td>1</td> <td>Minimum operating temperature</td> </tr> <tr> <td>2</td> <td>Normal temperature</td> </tr> <tr> <td>3</td> <td>Maximum operating temperature</td> </tr> <tr> <td>4</td> <td>Normal temperature</td> </tr> <tr> <td>Number of cycles</td> <td colspan="2">5 times</td> </tr> <tr> <td>Recovery</td> <td colspan="2">24 <math>\pm</math> 2 hrs (Standard condition) Note 3</td> </tr> </tbody> </table>			Class 1	Class 2	Preconditioning	None	Thermal treatment (at 150°C for 1 hr) Note 1	1 cycle	Step	Temperature (°C)	1	Minimum operating temperature	2	Normal temperature	3	Maximum operating temperature	4	Normal temperature	Number of cycles	5 times		Recovery	24 $\pm$ 2 hrs (Standard condition) Note 3	
		Class 1	Class 2																						
	Preconditioning	None	Thermal treatment (at 150°C for 1 hr) Note 1																						
	1 cycle	Step	Temperature (°C)																						
		1	Minimum operating temperature																						
		2	Normal temperature																						
3		Maximum operating temperature																							
4	Normal temperature																								
Number of cycles	5 times																								
Recovery	24 $\pm$ 2 hrs (Standard condition) Note 3																								

#### 15. Humidity (Steady state)

Specified Value	Temperature Compensating(Class1)	Appearance : No abnormality Capacitance change : Within $\pm 5\%$ or $\pm 0.5\text{pF}$ , whichever is larger. Q : $C < 10\text{pF} : Q \geq 200 + 10C$ $10 \leq C < 30\text{pF} : Q \geq 275 + 2.5C$ $C \geq 30\text{pF} : Q \geq 350$ (C:Nominal capacitance) Insulation resistance : 1000 M $\Omega$ min.
	High Permittivity (Class2)	Appearance : No abnormality Capacitance change : $\pm 12.5\%$ max(1005type), $\pm 15\%$ max(1608type min), $\pm 5\%$ max(SD) Dissipation factor : 5%max(H: 1005type,Q, S, X), 7%max(H: 1608type min), 0.5%max(SD). Insulation resistance : 25M $\Omega$ $\mu$ F or 1000M $\Omega$ , whichever is smaller.
Test Methods and Remarks	Preconditioning : Thermal treatment(at 150°C for 1hr) Note1 (Only High permittivity) Temperature : 40 $\pm$ 2°C Humidity : 90 to 95%RH Duration : 500 +24/−0 hrs Recovery : 24 $\pm$ 2hrs under the standard condition Note3	

#### 16. Humidity Loading

Specified Value	Temperature Compensating(Class1)	Appearance : No abnormality Capacitance change : Within $\pm 7.5\%$ or $\pm 0.75\text{pF}$ , whichever is larger Q : $C < 30\text{pF} : Q \geq 100 + 10C/3$ $C \geq 30\text{pF} : Q \geq 200$ (C:Nominal capacitance) Insulation resistance : 500 M $\Omega$ min.
	High Permittivity (Class2)	Appearance : No abnormality Capacitance change : $\pm 12.5\%$ max(1005type), $\pm 15\%$ max(1608type min), $\pm 7.5\%$ max(SD) Dissipation factor : 5%max(H: 1005type,Q, S, X), 7%max(H: 1608type min), 0.5%max(SD) Insulation resistance : 10M $\Omega$ $\mu$ F or 500M $\Omega$ , whichever is smaller.
Test Methods and Remarks	Preconditioning : Voltage treatment(Rated voltage are applied for 1 hour at 40°C)Note 2 (Only High permittivity) Temperature : 40 $\pm$ 2°C Humidity : 90 to 95%RH Duration : 500 +24/−0 hrs Applied voltage : Rated voltage Charge/discharge current : 50mA max. Recovery : 24 $\pm$ 2hrs under the standard condition Note3	

► This catalog contains the typical specification only due to the limitation of space. When you consider the purchase of our products, please check our specification.  
For details of each product (characteristics graph, reliability information, precautions for use, and so on), see our Web site (<http://www.ty-top.com/>).

17. High Temperature Loading

Specified Value	Temperature Compensating(Class1)	Appearance : No abnormality Capacitance change : Within $\pm 3\%$ or $\pm 0.3\text{pF}$ , whichever is larger Q : $C < 10\text{pF}$ : $Q \geq 200 + 10C$ $10 \leq C < 30\text{pF}$ : $Q \geq 275 + 2.5C$ $C \geq 30\text{pF}$ : $Q \geq 350$ (C:Nominal capacitance) Insulation resistance : $1000\text{ M}\Omega$ min.
	High Permittivity (Class2)	Appearance : No abnormality Capacitance change : $\pm 12.5\% \text{max}(1005\text{type})$ , $\pm 15\% \text{max}(1608\text{type min})$ , $\pm 3\% \text{max}(SD)$ Dissipation factor : $5\% \text{max}(H: 1005\text{type}, Q, S, X)$ , $7\% \text{max}(H: 1608\text{type min})$ , $0.35\% \text{max}(SD)$ Insulation resistance : $50\text{M}\Omega \mu\text{F}$ or $1000\text{M}\Omega$ , whichever is smaller.
Test Methods and Remarks	Preconditioning : Voltage treatment(Twice the rated voltage shall be applied for 1 hour at $85^\circ\text{C}$ or $125^\circ\text{C}$ ) Note 2 (Only High permittivity) Temperature : Maximum operating temperature Duration : $1000 + 24/-0$ hrs Applied voltage : Rated voltage(H) $\times 2$ , Rated voltage(Q) $\times 1.5$ , Rated voltage $\times 1.2$ (S, X) $\times 1.2$ Charge/discharge current : $50\text{mA}$ max. Recovery : $24 \pm 2$ hrs under the standard condition Note3	
Note1 Thermal treatment : Initial value shall be measured after test sample is heat-treated at $150 \pm 0/-10^\circ\text{C}$ for an hour and kept at room temperature for $24 \pm 2$ hours. Note2 Voltage treatment : Initial value shall be measured after test sample is voltage-treated for an hour at both the temperature and voltage specified in the test conditions, and kept at room temperature for $24 \pm 2$ hours. Note3 Standard condition : Temperature: $5$ to $35^\circ\text{C}$ , Relative humidity: $45$ to $85\%$ RH, Air pressure: $86$ to $106\text{kPa}$ When there are questions concerning measurement results, in order to provide correlation data, the test shall be conducted under the following condition. Temperature: $20 \pm 2^\circ\text{C}$ , Relative humidity: $60$ to $70\%$ RH, Air pressure: $86$ to $106\text{kPa}$ Unless otherwise specified, all the tests are conducted under the "standard condition".		

# Multilayer Ceramic Capacitors

## PRECAUTIONS

### 1. Circuit Design

- Precautions**
- ◆ Verification of operating environment, electrical rating and performance
    1. A malfunction of equipment in fields such as medical, aerospace, nuclear control, etc. may cause serious harm to human life or have severe social ramifications. Therefore, any capacitors to be used in such equipment may require higher safety and reliability, and shall be clearly differentiated from them used in general purpose applications.
  - ◆ Operating Voltage (Verification of Rated voltage)
    1. The operating voltage for capacitors must always be their rated voltage or less.
      - If an AC voltage is loaded on a DC voltage, the sum of the two peak voltages shall be the rated voltage or less.
      - For a circuit where an AC or a pulse voltage may be used, the sum of their peak voltages shall also be the rated voltage or less.
    2. Even if an applied voltage is the rated voltage or less reliability of capacitors may be deteriorated in case that either a high frequency AC voltage or a pulse voltage having rapid rise time is used in a circuit.

### 2. PCB Design

- Precautions**
- ◆ Pattern configurations (Design of Land-patterns)
    1. When capacitors are mounted on PCBs, the amount of solder used (size of fillet) can directly affect the capacitor performance. Therefore, the following items must be carefully considered in the design of land patterns:
      - (1) Excessive solder applied can cause mechanical stresses which lead to chip breaking or cracking. Therefore, please consider appropriate land-patterns for proper amount of solder.
      - (2) When more than one component are jointly soldered onto the same land, each component's soldering point shall be separated by solder-resist.
  - ◆ Pattern configurations (Capacitor layout on PCBs)
 

After capacitors are mounted on boards, they can be subjected to mechanical stresses in subsequent manufacturing processes (PCB cutting, board inspection, mounting of additional parts, assembly into the chassis, wave soldering of the boards, etc.). For this reason, land pattern configurations and positions of capacitors shall be carefully considered to minimize stresses.

**Technical considerations**

- ◆ Pattern configurations (Design of Land-patterns)
 

The following diagrams and tables show some examples of recommended land patterns to prevent excessive solder amounts.

(1) Recommended land dimensions for typical chip capacitors

  - Multilayer Ceramic Capacitors : Recommended land dimensions (unit: mm)

**Wave-soldering**

Type	1608	2012	3216	3225	
Size	L	1.6	2.0	3.2	3.2
	W	0.8	1.25	1.6	2.5
A	0.8 to 1.0	1.0 to 1.4	1.8 to 2.5	1.8 to 2.5	
B	0.5 to 0.8	0.8 to 1.5	0.8 to 1.7	0.8 to 1.7	
C	0.6 to 0.8	0.9 to 1.2	1.2 to 1.6	1.8 to 2.5	

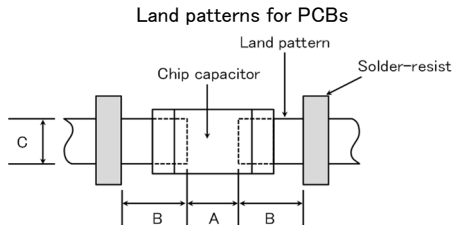

**Reflow-soldering**

Type	0201	0402	0603	1005	1608	2012	3216	3225	4532
Size	L	0.25	0.4	0.6	1.0	1.6	2.0	3.2	4.5
	W	0.125	0.2	0.3	0.5	0.8	1.25	1.6	3.2
A	0.095~0.135	0.15~0.25	0.20~0.30	0.45~0.55	0.6~0.8	0.8~1.2	1.8~2.5	1.8~2.5	2.5~3.5
B	0.085~0.125	0.10~0.20	0.20~0.30	0.40~0.50	0.6~0.8	0.8~1.2	1.0~1.5	1.0~1.5	1.5~1.8
C	0.110~0.150	0.15~0.30	0.25~0.40	0.45~0.55	0.6~0.8	0.9~1.6	1.2~2.0	1.8~3.2	2.3~3.5

Note: Recommended land size might be different according to the allowance of the size of the product.

  - LWDC: Recommended land dimensions for reflow-soldering (unit: mm)

Type	0510	0816	1220	
Size	L	0.52	0.8	1.25
	W	1.0	1.6	2.0
A	0.18~0.22	0.25~0.3	0.5~0.7	
B	0.2~0.25	0.3~0.4	0.4~0.5	
C	0.9~1.1	1.5~1.7	1.9~2.1	

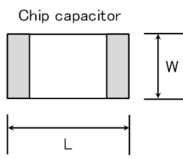

▶ This catalog contains the typical specification only due to the limitation of space. When you consider the purchase of our products, please check our specification. For details of each product (characteristics graph, reliability information, precautions for use, and so on), see our Web site (<http://www.ty-top.com/>).

(2) Examples of good and bad solder application

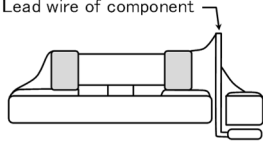
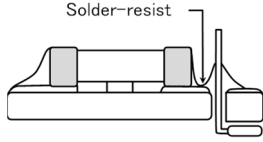
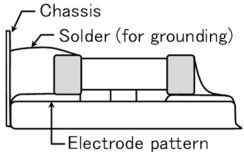
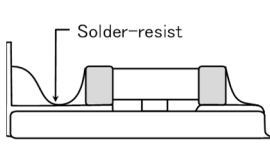
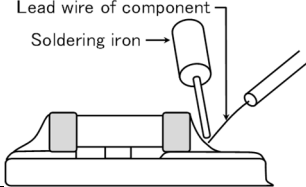
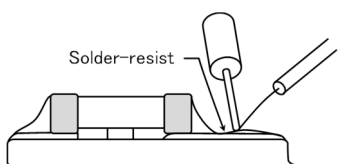
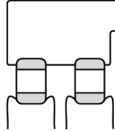
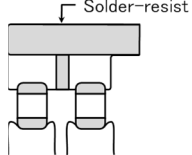
Item	Not recommended	Recommended
Mixed mounting of SMD and leaded components		
Component placement close to the chassis		
Hand-soldering of leaded components near mounted components		
Horizontal component placement		

◆ Pattern configurations (Capacitor layout on PCBs)

1-1. The following is examples of good and bad capacitor layouts ; capacitors shall be located to minimize any possible mechanical stresses from board warp or deflection.

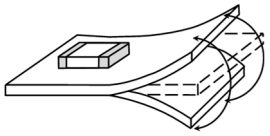
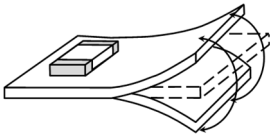
Items	Not recommended	Recommended
Deflection of board		 Place the product at a right angle to the direction of the anticipated mechanical stress.

1-2. The amount of mechanical stresses given will vary depending on capacitor layout. Please refer to diagram below.

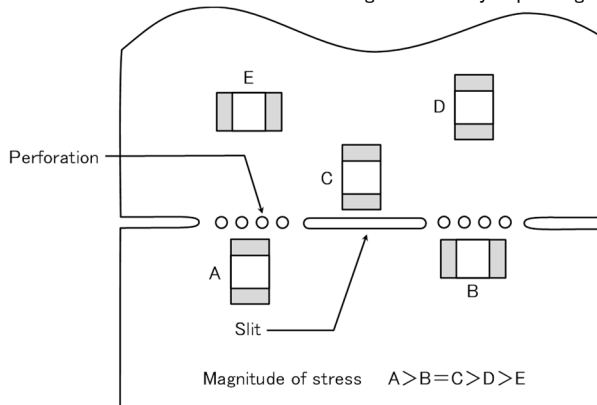

1-3. When PCB is split, the amount of mechanical stress on the capacitors can vary according to the method used. The following methods are listed in order from least stressful to most stressful: push-back, slit, V-grooving, and perforation. Thus, please consider the PCB, split methods as well as chip location.

3. Mounting

Precautions

◆ Adjustment of mounting machine

- When capacitors are mounted on PCB, excessive impact load shall not be imposed on them.
- Maintenance and inspection of mounting machines shall be conducted periodically.

◆ Selection of Adhesives

- When chips are attached on PCBs with adhesives prior to soldering, it may cause capacitor characteristics degradation unless the following factors are appropriately checked : size of land patterns, type of adhesive, amount applied, hardening temperature and hardening period. Therefore, please contact us for further information.

◆ Adjustment of mounting machine

1. When the bottom dead center of a pick-up nozzle is too low, excessive force is imposed on capacitors and causes damages. To avoid this, the following points shall be considerable.
  - (1) The bottom dead center of the pick-up nozzle shall be adjusted to the surface level of PCB without the board deflection.
  - (2) The pressure of nozzle shall be adjusted between 1 and 3 N static loads.
  - (3) To reduce the amount of deflection of the board caused by impact of the pick-up nozzle, supporting pins or back-up pins shall be used on the other side of the PCB. The following diagrams show some typical examples of good and bad pick-up nozzle placement:

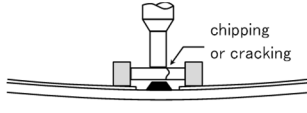
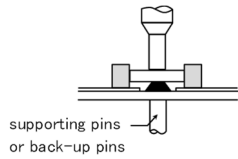
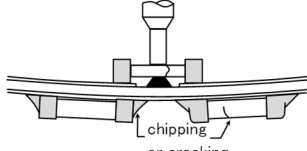
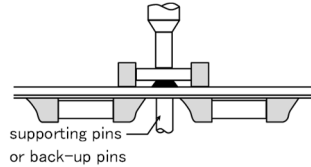
Item	Improper method	Proper method
Single-sided mounting		
Double-sided mounting		

Technical considerations

2. As the alignment pin is worn out, adjustment of the nozzle height can cause chipping or cracking of capacitors because of mechanical impact on the capacitors. To avoid this, the monitoring of the width between the alignment pins in the stopped position, maintenance, check and replacement of the pin shall be conducted periodically.

◆ Selection of Adhesives

Some adhesives may cause IR deterioration. The different shrinkage percentage of between the adhesive and the capacitors may result in stresses on the capacitors and lead to cracking. Moreover, too little or too much adhesive applied to the board may adversely affect components. Therefore, the following precautions shall be noted in the application of adhesives.

- (1) Required adhesive characteristics
  - a. The adhesive shall be strong enough to hold parts on the board during the mounting & solder process.
  - b. The adhesive shall have sufficient strength at high temperatures.
  - c. The adhesive shall have good coating and thickness consistency.
  - d. The adhesive shall be used during its prescribed shelf life.
  - e. The adhesive shall harden rapidly.
  - f. The adhesive shall have corrosion resistance.
  - g. The adhesive shall have excellent insulation characteristics.
  - h. The adhesive shall have no emission of toxic gasses and no effect on the human body.
- (2) The recommended amount of adhesives is as follows:

[Recommended condition]

Figure	2012/3216 case sizes as examples
a	0.3mm min
b	100 to 120 μm
c	Adhesives shall not contact land

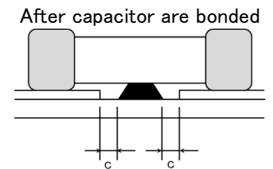
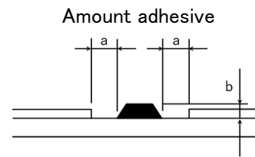

4. Soldering

◆ Selection of Flux

- Since flux may have a significant effect on the performance of capacitors, it is necessary to verify the following conditions prior to use;
- (1) Flux used shall be less than or equal to 0.1 wt% ( in Cl equivalent) of halogenated content. Flux having a strong acidity content shall not be applied.
  - (2) When shall capacitors are soldered on boards, the amount of flux applied shall be controlled at the optimum level.
  - (3) When water-soluble flux is used, special care shall be taken to properly clean the boards.

Precautions

◆ Soldering

Temperature, time, amount of solder, etc. shall be set in accordance with their recommended conditions. Sn-Zn solder paste can adversely affect MLCC reliability. Please contact us prior to usage of Sn-Zn solder.

Technical considerations

◆ Selection of Flux

- 1-1. When too much halogenated substance (Chlorine, etc.) content is used to activate flux, or highly acidic flux is used, it may lead to corrosion of terminal electrodes or degradation of insulation resistance on the surfaces of the capacitors.
- 1-2. Flux is used to increase solderability in wave soldering. However if too much flux is applied, a large amount of flux gas may be emitted and may adversely affect the solderability. To minimize the amount of flux applied, it is recommended to use a flux-bubbling system.
- 1-3. Since the residue of water-soluble flux is easily dissolved in moisture in the air, the residues on the surfaces of capacitors in high humidity conditions may cause a degradation of insulation resistance and reliability of the capacitors. Therefore, the cleaning methods

► This catalog contains the typical specification only due to the limitation of space. When you consider the purchase of our products, please check our specification. For details of each product (characteristics graph, reliability information, precautions for use, and so on), see our Web site (<http://www.ty-top.com/>).

and the capability of the machines used shall also be considered carefully when water-soluble flux is used.

◆Soldering

- Ceramic chip capacitors are susceptible to thermal shock when exposed to rapid or concentrated heating or rapid cooling.
- Therefore, the soldering must be conducted with great care so as to prevent malfunction of the components due to excessive thermal shock.
- Preheating : Capacitors shall be preheated sufficiently, and the temperature difference between the capacitors and solder shall be within 130°C.
- Cooling : The temperature difference between the capacitors and cleaning process shall not be greater than 100°C.

[Reflow soldering]

【Recommended conditions for eutectic soldering】

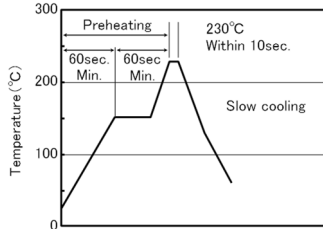

【Recommended condition for Pb-free soldering】

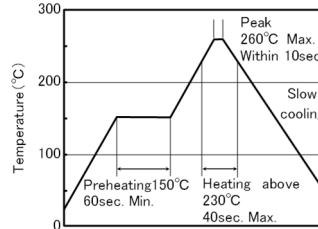

Caution

- ①The ideal condition is to have solder mass (fillet) controlled to 1/2 to 1/3 of the thickness of a capacitor.
- ②Because excessive dwell times can adversely affect solderability, soldering duration shall be kept as close to recommended times as possible. soldering for 2 times.

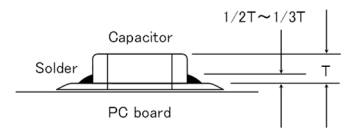

[Wave soldering]

【Recommended conditions for eutectic soldering】

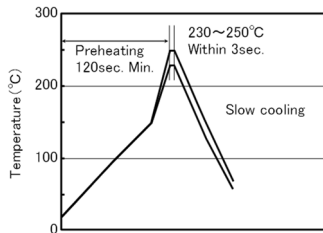

【Recommended condition for Pb-free soldering】

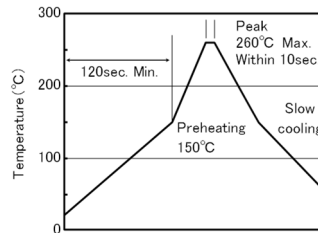

Caution

- ①Wave soldering must not be applied to capacitors designated as for reflow soldering only. soldering for 1 times.

[Hand soldering]

【Recommended conditions for eutectic soldering】

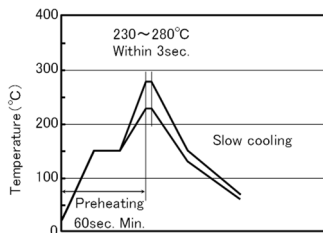

【Recommended condition for Pb-free soldering】

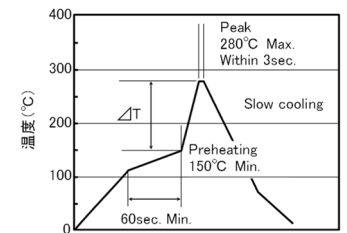
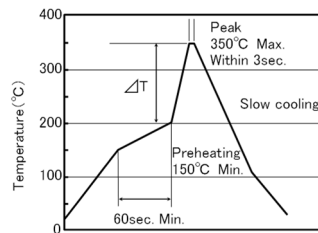

	$\Delta T$
3216type or less	$\Delta T \leq 150^{\circ}\text{C}$

	$\Delta T$
3225type or more	$\Delta T \leq 130^{\circ}\text{C}$

Caution

- ①Use a 50W soldering iron with a maximum tip diameter of 1.0 mm.
- ②The soldering iron shall not directly touch capacitors. soldering for 1 times.

► This catalog contains the typical specification only due to the limitation of space. When you consider the purchase of our products, please check our specification. For details of each product (characteristics graph, reliability information, precautions for use, and so on), see our Web site (<http://www.ty-top.com/>).

5. Cleaning	
Precautions	<p>◆Cleaning conditions</p> <ol style="list-style-type: none"> <li>When PCBs are cleaned after capacitors mounting, please select the appropriate cleaning solution in accordance with the intended use of the cleaning. (e.g. to remove soldering flux or other materials from the production process.)</li> <li>Cleaning condition shall be determined after it is verified by using actual cleaning machine that the cleaning process does not affect capacitor's characteristics.</li> </ol>
Technical considerations	<ol style="list-style-type: none"> <li>The use of inappropriate cleaning solutions can cause foreign substances such as flux residue to adhere to capacitors or deteriorate their outer coating, resulting in a degradation of the capacitor's electrical properties (especially insulation resistance).</li> <li>Inappropriate cleaning conditions (insufficient or excessive cleaning) may adversely affect the performance of the capacitors. In the case of ultrasonic cleaning, too much power output can cause excessive vibration of PCBs which may lead to the cracking of capacitors or the soldered portion, or decrease the terminal electrodes' strength. Therefore, the following conditions shall be carefully checked:            Ultrasonic output : 20 W/l or less      Ultrasonic frequency : 40 kHz or less            Ultrasonic washing period : 5 min. or less</li> </ol>

6. Resin coating and mold	
Precautions	<ol style="list-style-type: none"> <li>With some type of resins, decomposition gas or chemical reaction vapor may remain inside the resin during the hardening period or while left under normal storage conditions resulting in the deterioration of the capacitor's performance.</li> <li>When a resin's hardening temperature is higher than capacitor's operating temperature, the stresses generated by the excessive heat may lead to damage or destruction of capacitors. The use of such resins, molding materials etc. is not recommended.</li> </ol>

7. Handling	
Precautions	<p>◆Splitting of PCB</p> <ol style="list-style-type: none"> <li>When PCBs are split after components mounting, care shall be taken so as not to give any stresses of deflection or twisting to the board.</li> <li>Board separation shall not be done manually, but by using the appropriate devices.</li> </ol> <p>◆Mechanical considerations</p> <p>Be careful not to subject capacitors to excessive mechanical shocks.</p> <ol style="list-style-type: none"> <li>If ceramic capacitors are dropped onto a floor or a hard surface, they shall not be used.</li> <li>Please be careful that the mounted components do not come in contact with or bump against other boards or components.</li> </ol>

8. Storage conditions	
Precautions	<p>◆Storage</p> <ol style="list-style-type: none"> <li>To maintain the solderability of terminal electrodes and to keep packaging materials in good condition, care must be taken to control temperature and humidity in the storage area. Humidity should especially be kept as low as possible.           <ul style="list-style-type: none"> <li>Recommended conditions                Ambient temperature : Below 30°C      Humidity : Below 70% RH</li> </ul>           The ambient temperature must be kept below 40°C. Even under ideal storage conditions, solderability of capacitor is deteriorated as time passes, so capacitors shall be used within 6 months from the time of delivery.           <ul style="list-style-type: none"> <li>Ceramic chip capacitors shall be kept where no chlorine or sulfur exists in the air.</li> </ul> </li> <li>The capacitance values of high dielectric constant capacitors will gradually decrease with the passage of time, so care shall be taken to design circuits. Even if capacitance value decreases as time passes, it will get back to the initial value by a heat treatment at 150°C for 1hour.</li> </ol>
Technical considerations	<p>If capacitors are stored in a high temperature and humidity environment, it might rapidly cause poor solderability due to terminal oxidation and quality loss of taping/packaging materials. For this reason, capacitors shall be used within 6 months from the time of delivery. If exceeding the above period, please check solderability before using the capacitors.</p>

※RCR-2335B (Safety Application Guide for fixed ceramic capacitors for use in electronic equipment) is published by JEITA.

Please check the guide regarding precautions for deflection test, soldering by spot heat, and so on.