

有关敝公司产品的注意事项

请务必在使用敝公司产品之前阅读。



注意

产品目录中的记载内容

本产品目录中所记载的内容为2023年3月的内容。因产品改良等原因，可能会不经预告而变更其记载内容，或是停止供应本产品目录中所记载的产品。所以，请务必在使用前先确认最新的产品信息。

未按照本产品目录中所记载的内容或交货规格说明书使用敝公司产品的，即便其致使用设备发生损害、不良情况等时，敝公司也不承担任何责任，敬请知悉。

签署交货规格说明书

就本产品目录中所记载产品的产品规格等相关内容，敝公司备有交货规格说明书，详情请向敝公司咨询。在使用敝公司产品前请务必就交货规格说明书之内容确认并批准之。

实装前的事前评估

使用敝公司产品时，请务必事先安装到使用设备之后，在实际使用的环境下进行评估和确认。

用途的限定

1. 可以使用的设备

本产品目录中所记载的产品预设为使用于一般民用电子设备〔音像设备、办公自动化设备、家电产品、办公设备、信息通讯设备（手机、电脑等）〕以及面向本产品目录或是交货规格说明书中另行注明的设备或是敝公司另行承诺的设备的通用性，标准性用途。另外，面向下述设备的应用，敝公司也备有预设的产品系列，请参考本产品目录或是交货规格说明书的内容，使用相对应的产品。

用途	产品系列		品质等级 ^(注释3)
	对象设备 ^(注释1)	规格号 (型号标记 ^(注释2))	
车载	汽车用电子设备（控制系 / 安全系）	A	1
	汽车用电子设备（车身系 / 情报系）	C	2
工业	通信基础设备·工业设备	B	2
医疗	医疗设备（国际（GHTF）第三类）	M	2
	医疗设备（国际（GHTF）第一类、第二类）	L	3
民用	一般电子设备	S	3
	移动设备专用 ^(注释4)	E	4

注释1：基于敝公司所认知的该类设备对于电子元器件所需的一般要求规格，对于该产品系列进行的应用推荐。在讨论将各个产品系列使用在对象设备以外的设备上时，请务必事先向敝公司咨询。

注释2：在产品型号中左起第2位标注有上表中所记载的“规格号”。对于相关的详细内容，请参照有关各产品型号标示法的说明资料。

注释3：在各产品系列中，都设定了从上至下1至4的“品质等级”。另外，在未得到敝公司的事前书面承诺之前，请勿将敝公司的产品使用于相对于该产品的品质等级被设定为上位品质等级的设备。

注释4：本产品系列仅可应用于一般民用电子设备中的移动设备（智能手机、平板电脑、智能手表、掌上游戏机等）。由于其设计、规格和使用环境与面向“一般电子设备”的产品系列（规格号：S）不同，有关本产品系列的详细信息请参照交货规格说明书。另外，面向“一般电子设备”的产品系列（规格号：S）也可以应用于移动设备。

2. 需要另行确认的设备

若考虑将本产品目录中所记载的产品使用于当产品发生故障、品质不良，或是由此引起的运转失常而可能会危及生命、身体或是财产，以及有可能给社会造成深刻影响的以下设备（不包括本产品目录或是交货规格说明书中另行注明可以使用设备）等时，请务必事先向敝公司咨询。

- (1) 运输用设备（汽车驱动控制设备、火车控制设备、船舶控制设备等）
- (2) 交通信号设备
- (3) 防灾 / 保安设备
- (4) 医疗设备（国际（GHTF）第三类）
- (5) 高公共性信息通讯设备 / 信息处理设备（电话交换机、电话 / 无线 / 广播电视基站等）
- (6) 其他与上述设备有同等品质与可靠性要求的设备

3. 禁止使用的设备

请勿将敝公司产品使用于对安全性和可靠性有着极高要求的以下设备。

- (1) 航天设备（人工卫星、火箭等）
- (2) 航空设备^(注释1)
- (3) 医疗设备（国际（GHTF）第四类）、植体（体内植入型）医疗设备^(注释2)
- (4) 发电控制设备（面向核能 / 水力 / 火力发电厂等的设备）
- (5) 海底设备（海底中继设备、海中的作业设备等）
- (6) 军事设备
- (7) 其他与上述设备有同等品质与可靠性要求的设备

注释1：仅限于对航空设备的安全运行不产生直接干扰的设备 [机内娱乐设备、机内照明设备、电动座椅、餐饮设备等]，在满足敝公司另行指定的相关条件时，亦可将敝公司产品用于以上用途。在贵公司考虑将敝公司的产品用于以上用途时，请务必事先向敝公司咨询相关的信息。

注释2：包括注入人体内的部分和与此相连接的体外部分。

4. 责任的限制

未经敝公司的事先书面同意，把本产品目录中所记载的产品使用于非敝公司预设用途的设备、前述需要向敝公司咨询的设备或敝公司禁止使用的设备，从而给客户或第三方造成损害的，敝公司不承担任何责任，敬请知悉。

■ 安全设计

需将敝公司的产品使用于对安全性和可靠性要求较高的设备、电路上时，请进行充分的安全性评估和可靠性评估。另外，请通过设置保护电路、保护装置的系统，设置冗余电路不会被单一故障影响安全性的系统等失效导向安全（fail-safe）设计，确保充分的安全性。

■ 有关知识产权

本产品目录中所记载的信息是用于说明相关产品的典型操作以及相关应用。此类信息的使用不代表对于敝公司以及第三方的知识产权以及其他权利的使用许可或是不侵权保证。

■ 保证范围

敝公司产品的保证范围仅限于符合交货规格说明书中所记载的产品规格且已经交付的敝公司产品本身，由敝公司产品的故障或不良情况所诱发的损害，敝公司不承担任何责任，敬请知悉。但是，仅限于敝公司的产品作为通用性，标准性用途使用于本产品目录或是交货规格说明书中另行注明的设备，且以书面形式另行签署了交易基本合同书，品质保证协定时，敝公司将根据该合同等的条件提供保证。

■ 正规销售渠道

本产品目录中所记载的内容适用于从敝公司营业所、销售子公司、销售代理店（即“正规销售渠道”）购买的敝公司产品，并不适用于从其他渠道购买的敝公司产品，敬请知悉。

■ 出口时的注意事项

本产品目录中所记载的部分产品在出口时须事先确认《外汇和对外贸易法》以及美国在出口管理方面的相关法规，并办理相关手续。如有不明之处，请向敝公司咨询。

▶ 由于篇幅有限，本产品目录中只记载了有代表性的产品规格，若考虑使用敝公司产品时，请确认交货规格说明书中的详细规格。另外，有关各产品的详细信息（特性图、可靠性信息、使用时的注意事项等），请参阅敝公司网站（<http://www.ty-top.com/>）。

一般民生用 多层陶瓷电容器

回流焊

■ 型号标示法

M	S	A	S	U	3	1	L	B	B	5	1	0	6	K	T	N	A	0	1
①	②	③	④	⑤	⑥	⑦	⑧	⑨	⑩										

①系列

代码 (1) (2) (3) (4)	
MSAS	一般民生用 多层陶瓷电容器 (高介电常数) 一般民生用 多层陶瓷电容器 (温度补偿用) 一般民生用 中高耐压多层陶瓷电容器
MSAR	一般民生用 高频/低损耗中高耐压多层陶瓷电容器
MSAY	一般民生用 低失真设计/声音/良好偏置多层陶瓷电容器
MSRL	一般民生用 LW 反转/低 ESL 多层陶瓷电容器 (LWDC™)

(1) 产品群

代码	
M	多层陶瓷电容器

(2) 范畴

代码	推荐设备	品质等级
S	一般民生用电子设备	3

(3) 类型

代码	
A	2 端接
R	LW 反转

(4) 特效 / 特性

代码	
S	标准/一般
R	高频/低损耗
Y	低失真设计/声音/良好偏置
L	低 ESL

②额定电压

代码	额定电压 [VDC]
P	2.5
A	4
J	6.3
L	10
E	16
T	25
G	35
U	50
H	100
Q	250
S	630
X	2000

④产品厚度

代码	产品厚度 [mm]
1	0.125
H	0.13 (1.5 max ※)
E	0.18 (1.1 max ※)
2	0.2
3	0.3
K	0.45
5	0.5
8	0.8
9	0.85
Q	1.15
G	1.25
L	1.6
N	1.9 (0.088 ※)
Y	2.0 max
M	2.5

③外型尺寸

代码	L×W [mm]	JIS (mm)	EIA (inch)
02	0.25 × 0.125	0201	008004
04	0.4 × 0.2	0402	01005
06	0.6 × 0.3	0603	0201
1L	1.0 × 0.5	1005	0402
10	1.0 × 0.5	1005	0402
	0.52 × 1.0 ※	0510	0204
16	1.6 × 0.8	1608	0603
	0.8 × 1.6 ※	0816	0306
21	2.0 × 1.25	2012	0805
	1.25 × 2.0 ※	1220	0508
31	3.2 × 1.6	3216	1206
32	3.2 × 2.5	3225	1210
45	4.5 × 3.2	4532	1812

注: ※LW 反转型 (MSRL)

注: ※LW 反转型 (MSRL)

由于篇幅有限,本产品目录中只记载了有代表性的产品规格,若考虑使用敝公司产品时,请确认交货规格说明书中的详细规格。
另外,有关各产品的详细信息(特性图、可靠性信息、使用时的注意事项等),请参阅敝公司网站(<http://www.ty-top.com/>)。

⑤产品尺寸公差

代码	外型尺寸记号	L [mm]	W [mm]	T [mm]	产品厚度代
A	06	0.6±0.05	0.3±0.05	0.3±0.05	3
	10	1.0±0.10	0.5±0.10	0.5±0.10	5
	16	1.6+0.15/-0.05	0.8+0.15/-0.05	0.8+0.15/-0.05	8
	21	2.0+0.15/-0.05	1.25+0.15/-0.05	1.25+0.15/-0.05	G
	31	3.2±0.20	1.6±0.20	1.6±0.20	L
	32	3.2±0.30	2.5±0.30	2.5±0.30	M
B	06	0.6±0.09	0.3±0.09	0.3±0.09	3
	10	1.0+0.15/-0.05	0.5+0.15/-0.05	0.5+0.15/-0.05	5
	16	1.6+0.20/-0	0.8+0.20/-0	0.8+0.20/-0	8
	21	2.0+0.20/-0	1.25+0.20/-0	1.25+0.20/-0	G
	31	3.2±0.30	1.6±0.30	1.6±0.30	L
	32	3.2±0.30	2.5±0.20	1.9+0.1/-0.20	Y
C	10	1.0+0.20/-0	0.5+0.20/-0	0.5+0.20/-0	5
E	06	0.6+0.25/-0	0.3+0.25/-0	0.3+0.25/-0	3
	10	1.0+0.30/-0	0.5+0.30/-0	0.5+0.30/-0	5
H	31	3.2±0.15	1.6±0.15	0.85±0.10	9
				1.15±0.10	Q
J	16	1.6+0.20/-0	0.8+0.20/-0	0.45±0.05	K
	21	2.0+0.15/-0.05	1.25+0.15/-0.05	0.85±0.10	9
	32	3.2±0.30	2.5±0.20	0.85±0.10 1.15±0.10	9 Q
L	21	2.0+0.20/-0	1.25+0.20/-0	0.85±0.10	9
	31	3.2±0.20	1.6±0.20	0.85±0.10	9
S	02	0.25±0.013	0.125±0.013	0.125±0.013	1
	04	0.4±0.02	0.2±0.02	0.2±0.02	2
	06	0.6±0.03	0.3±0.03	0.3±0.03	3
	10	1.0±0.05	0.5±0.05	0.5±0.05	5
		0.52±0.05 ※	1.0±0.05	0.3±0.05	3
	16	1.6±0.10	0.8±0.10	0.8±0.10	8
		0.8±0.10 ※	1.6±0.10	0.5±0.05	5
	21	2.0±0.10	1.25±0.10	0.85±0.10 1.25±0.10	9 G
		1.25±0.15 ※	2.0±0.15	0.85±0.10	9
	31	3.2±0.15	1.6±0.15	1.6±0.20	L
	32	3.2±0.30	2.5±0.20	2.5±0.20	M
1.9±0.20				N	
45	4.5±0.40	3.2±0.30	2.5±0.20	M	
T	16	1.6±0.10	0.8±0.10	0.45±0.05	K
X	1L	1.0±0.05	0.5±0.05	0.13±0.02	H
				0.18±0.02	E
				0.2±0.02	2
Y	1L	1.0±0.05	0.5±0.05	0.3±0.03	3

注：※LW 反转型 (MSRL)

④温度特性

■高介电常数【SD: 低失真设计/声音/良好偏置多层陶瓷电容器除外】

代码	适用标准		温度范围 [°C]	基准温度 [°C]	静电容量变化率	静电容量允许偏差	允许偏差代码
B5	JIS	B	-25~+85	20	±10%	±10%	K
						±20%	M
B7	EIA	X5R	-55~+85	25	±15%	±10%	K
						±20%	M
C6	EIA	X7R	-55~+125	25	±15%	±10%	K
						±20%	M
C7	EIA	X6S	-55~+105	25	±22%	±10%	K
						±20%	M
LD(※)	EIA	X7S	-55~+125	25	±22%	±10%	K
						±20%	M
LD(※)	EIA	X5R	-55~+85	25	±15%	±10%	K
						±20%	M

注: ※LD: 低失真设计/声音/良好偏置多层陶瓷电容器

■温度补偿用

代码	适用标准		温度范围 [°C]	基准温度 [°C]	静电容量变化率	静电容量允许偏差	允许偏差代码		
CG	JIS	CG	-55~+125	20	0±30ppm/°C	±0.05pF	A		
						±0.1pF	B		
	±0.25pF	C							
	±0.5pF	D							
CH	EIA	C0G	-55~+125	25	0±30ppm/°C	±2%	G		
						±5%	J		
	JIS	CH		-55~+125		20	0±60ppm/°C	±0.05pF	A
								±0.1pF	B
±0.25pF	C								
±0.5pF	D								
CJ	EIA	C0H	-55~+125	25	0±60ppm/°C	±2%	G		
						±5%	J		
	JIS	CJ		-55~+125		20	0±120ppm/°C	±0.05pF	A
								±0.1pF	B
±0.25pF	C								
±0.5pF	D								
CK	EIA	C0J	-55~+125	25	0±120ppm/°C	±0.05pF	A		
						±0.1pF	B		
	±0.25pF	C							
	±0.5pF	D							
CK	JIS	CK	-55~+125	20	0±250ppm/°C	±0.05pF	A		
						±0.1pF	B		
	±0.25pF	C							
	±0.5pF	D							
CK	EIA	C0K	-55~+125	25	0±250ppm/°C	±0.05pF	A		
						±0.1pF	B		
	±0.25pF	C							
	±0.5pF	D							

⑥系列名称

·低失真设计/声音/良好偏置多层陶瓷电容器

代码	系列名称
SD	标准品

·中高耐压多层陶瓷电容器

代码	系列名称
SD	标准品

⑦静电容量

代码(例)	静电容量
OR5	0.5pF
010	1pF
100	10pF
101	100pF
102	1,000pF
103	0.01μF
104	0.1μF
105	1μF
106	10μF
107	100μF

注: R=小数点

⑧静电容量允许偏差

代码	静电容量允许偏差
A	±0.05pF
B	±0.1pF
C	±0.25pF
D	±0.5pF
G	±2%
J	±5%
K	±10%
M	±20%

⑨包装

代码	包装规格
F	φ178mm 卷盘带装 (2mm 间隔)
T	φ178mm 卷盘带装 (4mm 间隔)
P	φ178mm 卷盘带装 (4mm 间隔, 1000 个/卷盘) 3225 规格 (厚度代码 M)
R	φ178mm 压模带 1005 规格 (2mm 间隔) 1608 规格 (4mm 间隔)
W	φ178mm 压模带 (1mm 间隔) 0201/0402 规格

⑩管理记号

■标准产品尺寸

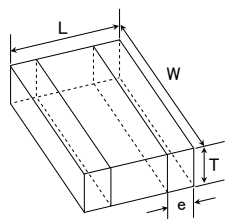
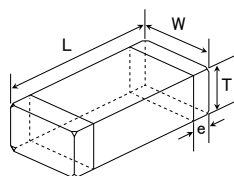

※LW 反转型

Type	JIS (mm)	EIA (inch)	标准产品尺寸 [mm]				
			L	W	T	*1	e
MSAS□02	0201	008004	0.25±0.013	0.125±0.013	0.125±0.013	1	0.0675±0.0275
MSAR□02	0201	008004	0.25±0.013	0.125±0.013	0.125±0.013	1	0.0675±0.0275
MSAS□04	0402	01005	0.4±0.02	0.2±0.02	0.2±0.02	2	0.1±0.03
MSAR□04	0402	01005	0.4±0.02	0.2±0.02	0.2±0.02	2	0.1±0.03
MSAS□06	0603	0201	0.6±0.03	0.3±0.03	0.3±0.03	3	0.15±0.05
MSAS□1L	1005	0402	1.0±0.05	0.5±0.05	0.13±0.02	H	0.25±0.10
					0.18±0.02	E	
					0.2±0.02	2	
					0.3±0.03	3	
MSAS□10	1005	0402	1.0±0.05	0.5±0.05	0.5±0.05	5	0.25±0.10
MSAY□1L	1005	0402	1.0±0.05	0.5±0.05	0.3±0.03	3	0.25±0.10
MSAY□10	1005	0402	1.0±0.05	0.5±0.05	0.5±0.05	5	0.25±0.10
MSRL□10 ※	0510	0204	0.52±0.05	1.0±0.05	0.3±0.05	3	0.18±0.08
MSAS□16	1608	0603	1.6±0.10	0.8±0.10	0.45±0.05	K	0.35±0.25
					0.8±0.10	8	
MSAY□16	1608	0603	1.6±0.10	0.8±0.10	0.8±0.10	8	0.35±0.25
MSRL□16 ※	0816	0306	0.8±0.10	1.6±0.10	0.5±0.05	5	0.25±0.15
MSAS□21	2012	0805	2.0±0.10	1.25±0.10	0.85±0.10	9	0.5±0.25
					1.25±0.10	G	
MSRL□21 ※	1220	0508	1.25±0.15	2.0±0.15	0.85±0.10	9	0.3±0.2
MSAS□31	3216	1206	3.2±0.15	1.6±0.15	0.85±0.10	9	0.5+0.35/-0.25
					1.15±0.10	Q	
					1.6±0.20	L	
MSAY□31	3216	1206	3.2±0.15	1.6±0.15	1.15±0.10	Q	0.5+0.35/-0.25
					1.6±0.20	L	
					0.85±0.10	9	
MSAS□32	3225	1210	3.2±0.30	2.5±0.20	1.15±0.10	Q	0.6±0.3
					1.9±0.20	N	
					1.9+0.1/-0.20	Y	
					2.5±0.20	M	
MSAY□32	3225	1210	3.2±0.30	2.5±0.20	1.9±0.20	N	0.6±0.3
					2.5±0.20	M	
MSAS□45	4532	1812	4.5±0.40	3.2±0.30	2.0+0/-0.30	Y	0.6±0.4
					2.5±0.20	M	

注： ※LW 反转型 (MSRL)、*1 产品厚度代码

■ 标准包装

外型			产品厚度		标准数量 [pcs]	
代码	JIS (mm)	EIA (inch)	[mm]	代码	纸带	压模带
02	0201	008004	0.125	1	—	50000
04	0402	01005	0.2	2	—	40000
06	0603	0201	0.3	3	15000	—
1L	1005	0402	0.13	H	—	20000
			0.18	E	—	15000
			0.2	2	20000	—
			0.3	3	15000	—
10	1005	0402	0.5	5	10000	—
	0510 ※	0204 ※	0.3	3		
16	1608	0603	0.45	K	4000	—
			0.8	8		
	0816 ※	0306 ※	0.5	5	—	4000
21	2012	0805	0.85	9	4000	—
			1.25	G	—	3000
	1220 ※	0508 ※	0.85	9	4000	—
31	3216	1206	0.85	9	4000	—
			1.15	Q	—	3000
			1.6	L	—	2000
32	3225	1210	0.85	9	—	2000
			1.15	Q		
			1.9	N		
			2.0 max	Y		
			2.5	M		
45	4532	1812	2.0 max	Y	—	1000
			2.5	M	—	500

注：※LW 反转型 (MSRL)

■ PART NUMBER

- All the Multilayer Ceramic Capacitors of the catalog lineup are RoHS Compliant.
- Capacitance tolerance code is applied to □ of part number.
- All the Multilayer Ceramic Capacitors in the catalog lineup are applicable for reflow-soldering. Please contact us for flow compatible products.

Note)
 *1 We may provide X7R/X7S for some items according to the individual specification.
 *2 The exchange of individual specification is necessary depending on the application and circuit condition. Please contact TAIYO YUDEN sales channels.
 *3 The size standard should look at Dimension, Thickness, Dimension tolerance, and STANDARD EXTERNAL DIMENSIONS.

Multilayer Ceramic Capacitors (High dielectric type) for General Electronic Equipment for Consumer

● 0201TYPE

【Temperature Characteristic B5(BJ) : X5R(−55~+85°C)】 0.125mm thickness

New part number	Old part number (for reference)	Rated voltage [V]	Temperature characteristics	Capacitance [F]	Capacitance tolerance [%]	tan δ [%]	HTLT	Thickness*3 [mm]	Note
							Rated voltage x %		
MSASE021SB5221□WNA01	EMK021 BJ221□K-W	16	X5R	220 p	±10, ±20	10	150	0.125±0.013	
MSASE021SB5471□WNA01	EMK021 BJ471□K-W		X5R	470 p	±10, ±20	10	150	0.125±0.013	
MSASE021SB5102□WNA01	EMK021 BJ102□K-W		X5R	1000 p	±10, ±20	10	150	0.125±0.013	
MSASJ021SB5222□WNA01	JMK021 BJ222□K-W	6.3	X5R	2200 p	±10, ±20	10	150	0.125±0.013	
MSASJ021SB5472□WNA01	JMK021 BJ472□K-W		X5R	4700 p	±10, ±20	10	150	0.125±0.013	
MSASJ021SB5103□WNA01	JMK021 BJ103□K-W		X5R	0.01 μ	±10, ±20	10	150	0.125±0.013	
MSASA021SB5223MWNA01	AMK021 BJ223MK-W	4	X5R	0.022 μ	±20	10	150	0.125±0.013	

● 0402TYPE

【Temperature Characteristic B5(BJ) : B(−25~+85°C)/X5R(−55~+85°C)】 0.2mm thickness

New part number	Old part number (for reference)	Rated voltage [V]	Temperature characteristics	Capacitance [F]	Capacitance tolerance [%]	tan δ [%]	HTLT	Thickness*3 [mm]	Note	
							Rated voltage x %			
MSASE042SB5101□WNA01	EMK042 BJ101□C-W	16	X5R	100 p	±10, ±20	5	200	0.2±0.02		
MSASE042SB5151□WNA01	EMK042 BJ151□C-W		X5R	150 p	±10, ±20	5	200	0.2±0.02		
MSASE042SB5221□WNA01	EMK042 BJ221□C-W		X5R	220 p	±10, ±20	5	200	0.2±0.02		
MSASE042SB5331□WNA01	EMK042 BJ331□C-W		X5R	330 p	±10, ±20	5	200	0.2±0.02		
MSASE042SB5471□WNA01	EMK042 BJ471□C-W		X5R	470 p	±10, ±20	5	200	0.2±0.02		
MSASE042SB5681□WNA01	EMK042 BJ681□C-W		X5R	680 p	±10, ±20	5	200	0.2±0.02		
MSASE042SB5102□WNA01	EMK042 BJ102□C-W		B	X5R	1000 p	±10, ±20	5	200	0.2±0.02	
MSASE042SB5152□WNA01	EMK042 BJ152□C-W		X5R	1500 p	±10, ±20	10	150	0.2±0.02		
MSASE042SB5222□WNA01	EMK042 BJ222□C-W		X5R	2200 p	±10, ±20	10	150	0.2±0.02		
MSASE042SB5332□WNA01	EMK042 BJ332□C-W		X5R	3300 p	±10, ±20	10	150	0.2±0.02		
MSASE042SB5472□WNA01	EMK042 BJ472□C-W	X5R	4700 p	±10, ±20	10	150	0.2±0.02			
MSASE042SB5682□WNA01	EMK042 BJ682□C-W	X5R	6800 p	±10, ±20	10	150	0.2±0.02			
MSASE042SB5103□WNA01	EMK042 BJ103□C-W	X5R	0.01 μ	±10, ±20	10	150	0.2±0.02			
MSASL042SB5101□WNA01	LМК042 BJ101□C-W	10	X5R*1	100 p	±10, ±20	5	200	0.2±0.02		
MSASL042SB5151□WNA01	LМК042 BJ151□C-W		X5R*1	150 p	±10, ±20	5	200	0.2±0.02		
MSASL042SB5221□WNA01	LМК042 BJ221□C-W		X5R*1	220 p	±10, ±20	5	200	0.2±0.02		
MSASL042SB5331□WNA01	LМК042 BJ331□C-W		X5R*1	330 p	±10, ±20	5	200	0.2±0.02		
MSASL042SB5471□WNA01	LМК042 BJ471□C-W		X5R*1	470 p	±10, ±20	5	200	0.2±0.02		
MSASL042SB5681□WNA01	LМК042 BJ681□C-W		X5R*1	680 p	±10, ±20	5	200	0.2±0.02		
MSASL042SB5102□WNA01	LМК042 BJ102□C-W		B	X5R*1	1000 p	±10, ±20	5	200	0.2±0.02	
MSASL042SB5152□WNA01	LМК042 BJ152□C-W		X5R	1500 p	±10, ±20	10	150	0.2±0.02		
MSASL042SB5222□WNA01	LМК042 BJ222□C-W		X5R	2200 p	±10, ±20	10	150	0.2±0.02		
MSASL042SB5332□WNA01	LМК042 BJ332□C-W		X5R	3300 p	±10, ±20	10	150	0.2±0.02		
MSASL042SB5472□WNA01	LМК042 BJ472□C-W	X5R	4700 p	±10, ±20	10	150	0.2±0.02			
MSASL042SB5682□WNA01	LМК042 BJ682□C-W	X5R	6800 p	±10, ±20	10	150	0.2±0.02			
MSASL042SB5103□WNA01	LМК042 BJ103□C-W	X5R	0.01 μ	±10, ±20	10	150	0.2±0.02			
MSASL042SB5104MWNA01	LМК042 BJ104MC-W	X5R	0.1 μ	±20	10	150	0.2±0.02			
MSASJ042SB5152□WNA01	JMK042 BJ152□C-W	6.3	X5R*1	1500 p	±10, ±20	10	150	0.2±0.02		
MSASJ042SB5222□WNA01	JMK042 BJ222□C-W		X5R*1	2200 p	±10, ±20	10	150	0.2±0.02		
MSASJ042SB5332□WNA01	JMK042 BJ332□C-W		X5R*1	3300 p	±10, ±20	10	150	0.2±0.02		
MSASJ042SB5472□WNA01	JMK042 BJ472□C-W		X5R*1	4700 p	±10, ±20	10	150	0.2±0.02		
MSASJ042SB5682□WNA01	JMK042 BJ682□C-W		X5R*1	6800 p	±10, ±20	10	150	0.2±0.02		
MSASJ042SB5103□WNA01	JMK042 BJ103□C-W		X5R*1	0.01 μ	±10, ±20	10	150	0.2±0.02		
MSASJ042SB5223□WNA01	JMK042 BJ223□C-W		X5R	0.022 μ	±10, ±20	10	150	0.2±0.02		
MSASJ042SB5473□WNA01	JMK042 BJ473□C-W		X5R	0.047 μ	±10, ±20	10	150	0.2±0.02		
MSASJ042SB5104□WNA01	JMK042 BJ104□C-W		X5R	0.1 μ	±10, ±20	10	150	0.2±0.02		
MSASA042SB5473□WNA01	AMK042 BJ473□C-W		X5R	0.047 μ	±10, ±20	10	150	0.2±0.02		
MSASA042SB5104□WNA01	AMK042 BJ104□C-W	4	X5R	0.1 μ	±10, ±20	10	150	0.2±0.02		

▶ This catalog contains the typical specification only due to the limitation of space. When you consider the purchase of our products, please check our specification.
 For details of each product (characteristics graph, reliability information, precautions for use, and so on), see our Web site (<http://www.ty-top.com/>).

PART NUMBER

【Temperature Characteristic B7 : X7R(−55~+125°C)】 0.2mm thickness

New part number	Old part number (for reference)	Rated voltage [V]	Temperature characteristics	Capacitance [F]	Capacitance tolerance [%]	tan δ [%]	HTLT	Thickness ³ [mm]	Note
							Rated voltage x %		
MSASE042SB7101[WNA01	EMK042 B7101[C-W	16	X7R	100 p	±10, ±20	5	200	0.2±0.02	
MSASE042SB7151[WNA01	EMK042 B7151[C-W		X7R	150 p	±10, ±20	5	200	0.2±0.02	
MSASE042SB7221[WNA01	EMK042 B7221[C-W		X7R	220 p	±10, ±20	5	200	0.2±0.02	
MSASE042SB7331[WNA01	EMK042 B7331[C-W		X7R	330 p	±10, ±20	5	200	0.2±0.02	
MSASE042SB7471[WNA01	EMK042 B7471[C-W		X7R	470 p	±10, ±20	5	200	0.2±0.02	
MSASE042SB7681[WNA01	EMK042 B7681[C-W		X7R	680 p	±10, ±20	5	200	0.2±0.02	
MSASE042SB7102[WNA01	EMK042 B7102[C-W	10	X7R	1000 p	±10, ±20	5	200	0.2±0.02	
MSASL042SB7101[WNA01	LMK042 B7101[C-W		X7R	100 p	±10, ±20	5	200	0.2±0.02	
MSASL042SB7151[WNA01	LMK042 B7151[C-W		X7R	150 p	±10, ±20	5	200	0.2±0.02	
MSASL042SB7221[WNA01	LMK042 B7221[C-W		X7R	220 p	±10, ±20	5	200	0.2±0.02	
MSASL042SB7331[WNA01	LMK042 B7331[C-W		X7R	330 p	±10, ±20	5	200	0.2±0.02	
MSASL042SB7471[WNA01	LMK042 B7471[C-W		X7R	470 p	±10, ±20	5	200	0.2±0.02	
MSASL042SB7681[WNA01	LMK042 B7681[C-W	X7R	680 p	±10, ±20	5	200	0.2±0.02		
MSASL042SB7102[WNA01	LMK042 B7102[C-W	X7R	1000 p	±10, ±20	5	200	0.2±0.02		

0603TYPE

【Temperature Characteristic B5(BJ) : B(−25~+85°C)/X5R(−55~+85°C)】 0.3mm thickness

New part number	Old part number (for reference)	Rated voltage [V]	Temperature characteristics	Capacitance [F]	Capacitance tolerance [%]	tan δ [%]	HTLT	Thickness ³ [mm]	Note	
							Rated voltage x %			
MSASU063SB5101[FNA01	UMK063 BJ101[P-F	50	B X5R ⁺	100 p	±10, ±20	3.5	200	0.3±0.03		
MSASU063SB5151[FNA01	UMK063 BJ151[P-F		B X5R ⁺	150 p	±10, ±20	3.5	200	0.3±0.03		
MSASU063SB5221[FNA01	UMK063 BJ221[P-F		B X5R ⁺	220 p	±10, ±20	3.5	200	0.3±0.03		
MSASU063SB5331[FNA01	UMK063 BJ331[P-F		B X5R ⁺	330 p	±10, ±20	3.5	200	0.3±0.03		
MSASU063SB5471[FNA01	UMK063 BJ471[P-F		B X5R ⁺	470 p	±10, ±20	3.5	200	0.3±0.03		
MSASU063SB5681[FNA01	UMK063 BJ681[P-F		B X5R ⁺	680 p	±10, ±20	3.5	200	0.3±0.03		
MSASU063SB5102[FNA01	UMK063 BJ102[P-F		B X5R ⁺	1000 p	±10, ±20	3.5	200	0.3±0.03		
MSASU063SB5152[FNA01	UMK063 BJ152[P-F		B X5R	1500 p	±10, ±20	5	200	0.3±0.03		
MSASU063SB5222[FNA01	UMK063 BJ222[P-F		B X5R	2200 p	±10, ±20	5	200	0.3±0.03		
MSASU063SB5332[FNA01	UMK063 BJ332[P-F		B X5R	3300 p	±10, ±20	5	200	0.3±0.03		
MSASU063SB5472[FNA01	UMK063 BJ472[P-F		B X5R	4700 p	±10, ±20	5	200	0.3±0.03		
MSASU063SB5682[FNA01	UMK063 BJ682[P-F		B X5R	6800 p	±10, ±20	5	200	0.3±0.03		
MSASU063SB5103[FNA01	UMK063 BJ103[P-F		B X5R	0.01 μ	±10, ±20	5	200	0.3±0.03		
MSASG063SB5104[FNA01	GMK063 BJ104[P-F		35	X5R	0.1 μ	±10, ±20	10	150	0.3±0.03	
MSAST063SB5152[FNA01	TMK063 BJ152[P-F			B X5R	1500 p	±10, ±20	5	200	0.3±0.03	
MSAST063SB5222[FNA01	TMK063 BJ222[P-F			B X5R	2200 p	±10, ±20	5	200	0.3±0.03	
MSAST063SB5332[FNA01	TMK063 BJ332[P-F			B X5R	3300 p	±10, ±20	5	200	0.3±0.03	
MSAST063SB5472[FNA01	TMK063 BJ472[P-F			B X5R	4700 p	±10, ±20	5	200	0.3±0.03	
MSAST063SB5682[FNA01	TMK063 BJ682[P-F	B X5R		6800 p	±10, ±20	5	200	0.3±0.03		
MSAST063SB5103[FNA01	TMK063 BJ103[P-F	B X5R	0.01 μ	±10, ±20	5	200	0.3±0.03			
MSAST063SB5223[FNA01	TMK063 BJ223[P-F	B X5R	0.022 μ	±10, ±20	7.5	200	0.3±0.03			
MSAST063AB5104[FNA01	TMK063ABJ104[P-F	X5R	0.1 μ	±10, ±20	10	150	0.3±0.05			
MSASE063SB5152[FNA01	EMK063 BJ152[P-F	16	B X5R ⁺	1500 p	±10, ±20	5	200	0.3±0.03		
MSASE063SB5222[FNA01	EMK063 BJ222[P-F		B X5R ⁺	2200 p	±10, ±20	5	200	0.3±0.03		
MSASE063SB5332[FNA01	EMK063 BJ332[P-F		B X5R ⁺	3300 p	±10, ±20	5	200	0.3±0.03		
MSASE063SB5472[FNA01	EMK063 BJ472[P-F		B X5R ⁺	4700 p	±10, ±20	5	200	0.3±0.03		
MSASE063SB5682[FNA01	EMK063 BJ682[P-F		B X5R ⁺	6800 p	±10, ±20	5	200	0.3±0.03		
MSASE063SB5103[FNA01	EMK063 BJ103[P-F		B X5R ⁺	0.01 μ	±10, ±20	5	200	0.3±0.03		
MSASE063SB5153[FNA01	EMK063 BJ153[P-F		X5R	0.015 μ	±10, ±20	7.5	200	0.3±0.03		
MSASE063SB5223[FNA01	EMK063 BJ223[P-F		B X5R	0.022 μ	±10, ±20	7.5	200	0.3±0.03		
MSASE063SB5333[FNA01	EMK063 BJ333[P-F		X5R	0.033 μ	±10, ±20	7.5	150	0.3±0.03		
MSASE063SB5473[FNA01	EMK063 BJ473[P-F		X5R	0.047 μ	±10, ±20	7.5	150	0.3±0.03		
MSASE063SB5683[FNA01	EMK063 BJ683[P-F		X5R	0.068 μ	±10, ±20	10	150	0.3±0.03		
MSASE063SB5104[FNA01	EMK063 BJ104[P-F		X5R	0.1 μ	±10, ±20	10	150	0.3±0.03		
MSASE063SB5224[FNA01	EMK063 BJ224[P-F		X5R	0.22 μ	±10, ±20	10	150	0.3±0.03		
MSASE063BB5474[FNB33	EMK063BBJ474[PLF		X5R	0.47 μ	±10, ±20	10	150	0.3±0.09		
MSASL063SB5223[FNA01	LMK063 BJ223[P-F		B X5R	0.022 μ	±10, ±20	7.5	150	0.3±0.03		
MSASL063SB5333[FNA01	LMK063 BJ333[P-F		X5R	0.033 μ	±10, ±20	7.5	150	0.3±0.03		
MSASL063SB5473[FNA01	LMK063 BJ473[P-F		X5R	0.047 μ	±10, ±20	7.5	150	0.3±0.03		
MSASL063SB5683[FNA01	LMK063 BJ683[P-F		X5R	0.068 μ	±10, ±20	10	150	0.3±0.03		
MSASL063SB5104[FNA01	LMK063 BJ104[P-F	X5R	0.1 μ	±10, ±20	10	150	0.3±0.03			
MSASL063SB5224[FNA01	LMK063 BJ224[P-F	X5R	0.22 μ	±10, ±20	10	150	0.3±0.03			
MSASL063BB5474[FNB33	LMK063BBJ474[PLF	X5R	0.47 μ	±10, ±20	10	150	0.3±0.09			
MSASL063BB5105MFNB33	LMK063BBJ105MPLF	X5R	1 μ	±20	10	150	0.3±0.09			
MSASJ063SB5104[FNA01	JMK063 BJ104[P-F	6.3	X5R	0.1 μ	±10, ±20	10	150	0.3±0.03		
MSASJ063SB5224[FNA01	JMK063 BJ224[P-F		X5R	0.22 μ	±10, ±20	10	150	0.3±0.03		
MSASJ063SB5334MFNA01	JMK063 BJ334MP-F		X5R	0.33 μ	±20	10	150	0.3±0.03		
MSASJ063SB5474[FNA01	JMK063 BJ474[P-F		X5R	0.47 μ	±10, ±20	10	150	0.3±0.03		
MSASJ063AB5105[FNA01	JMK063ABJ105[P-F		X5R	1 μ	±10, ±20	10	150	0.3±0.05		
MSASA063EB5475MFNA01	AMK063EBJ475MP-F		4	X5R	4.7 μ	±20	10	150	0.3+0.25/-0	
MSASP063EB5475MFNA01	PMK063EBJ475MP-F	2.5	X5R	4.7 μ	±20	10	150	0.3+0.25/-0		

▶ This catalog contains the typical specification only due to the limitation of space. When you consider the purchase of our products, please check our specification.
For details of each product (characteristics graph, reliability information, precautions for use, and so on), see our Web site (<http://www.ty-top.com/>).

PART NUMBER

【Temperature Characteristic C6 : X6S(-55~+105°C)】 0.3mm thickness

New part number	Old part number (for reference)	Rated voltage [V]	Temperature characteristics	Capacitance [F]	Capacitance tolerance [%]	tan δ [%]	HTLT	Thickness ³ [mm]	Note
							Rated voltage x %		
MSAST063SC6104[FNA01	TMK063 C6104[P-F	25	X6S	0.1 μ	±10, ±20	10	150	0.3±0.03	
MSASE063AC6104[FNA01	EMK063AC6104[P-F	16	X6S	0.1 μ	±10, ±20	10	150	0.3±0.05	
MSASL063SC6104[FNA01	LMK063 C6104[P-F	10	X6S	0.1 μ	±10, ±20	10	150	0.3±0.03	
MSASL063SC6224[FNA01	LMK063 C6224[P-F		X6S	0.22 μ	±10, ±20	10	150	0.3±0.03	
MSASL063BC6474[FNB33	LMK063BC6474[PLF	6.3	X6S	0.47 μ	±10, ±20	10	150	0.3±0.09	
MSASJ063SC6104[FNA01	JMK063 C6104[P-F		X6S	0.1 μ	±10, ±20	10	150	0.3±0.03	
MSASJ063SC6224[FNA01	JMK063 C6224[P-F	4	X6S	0.22 μ	±10, ±20	10	150	0.3±0.03	
MSASJ063BC6474[FNA01	JMK063BC6474[P-F		X6S	0.47 μ	±10, ±20	10	150	0.3±0.09	
MSASJ063BC6105MFNA01	JMK063BC6105MP-F	4	X6S	1 μ	±20	10	150	0.3±0.09	
MSASA063SC6474[FNA01	AMK063 C6474[P-F		X6S	0.47 μ	±10, ±20	10	150	0.3±0.03	
MSASA063AC6105[FNA01	AMK063AC6105[P-F		X6S	1 μ	±10, ±20	10	150	0.3±0.05	

【Temperature Characteristic B7 : X7R(-55~+125°C)】 0.3mm thickness

New part number	Old part number (for reference)	Rated voltage [V]	Temperature characteristics	Capacitance [F]	Capacitance tolerance [%]	tan δ [%]	HTLT	Thickness ³ [mm]	Note
							Rated voltage x %		
MSASU063SB7101[FNA01	UMK063 B7101[P-F	50	X7R	100 p	±10, ±20	3.5	200	0.3±0.03	
MSASU063SB7151[FNA01	UMK063 B7151[P-F		X7R	150 p	±10, ±20	3.5	200	0.3±0.03	
MSASU063SB7221[FNA01	UMK063 B7221[P-F		X7R	220 p	±10, ±20	3.5	200	0.3±0.03	
MSASU063SB7331[FNA01	UMK063 B7331[P-F		X7R	330 p	±10, ±20	3.5	200	0.3±0.03	
MSASU063SB7471[FNA01	UMK063 B7471[P-F		X7R	470 p	±10, ±20	3.5	200	0.3±0.03	
MSASU063SB7681[FNA01	UMK063 B7681[P-F		X7R	680 p	±10, ±20	3.5	200	0.3±0.03	
MSASU063SB7102[FNA01	UMK063 B7102[P-F	25	X7R	1000 p	±10, ±20	3.5	200	0.3±0.03	
MSAST063SB7152[FNA01	TMK063 B7152[P-F		X7R	1500 p	±10, ±20	5	200	0.3±0.03	
MSAST063SB7222[FNA01	TMK063 B7222[P-F		X7R	2200 p	±10, ±20	5	200	0.3±0.03	
MSAST063SB7332[FNA01	TMK063 B7332[P-F		X7R	3300 p	±10, ±20	5	200	0.3±0.03	
MSAST063SB7472[FNA01	TMK063 B7472[P-F		X7R	4700 p	±10, ±20	5	200	0.3±0.03	
MSAST063SB7682[FNA01	TMK063 B7682[P-F		X7R	6800 p	±10, ±20	5	200	0.3±0.03	
MSAST063SB7103[FNA01	TMK063 B7103[P-F	16	X7R	6800 p	±10, ±20	5	200	0.3±0.03	
MSASE063SB7152[FNA01	EMK063 B7152[P-F		X7R	0.01 μ	±10, ±20	5	200	0.3±0.03	
MSASE063SB7222[FNA01	EMK063 B7222[P-F		X7R	1500 p	±10, ±20	5	200	0.3±0.03	
MSASE063SB7332[FNA01	EMK063 B7332[P-F		X7R	2200 p	±10, ±20	5	200	0.3±0.03	
MSASE063SB7472[FNA01	EMK063 B7472[P-F		X7R	3300 p	±10, ±20	5	200	0.3±0.03	
MSASE063SB7682[FNA01	EMK063 B7682[P-F		X7R	4700 p	±10, ±20	5	200	0.3±0.03	
MSASE063SB7103[FNA01	EMK063 B7103[P-F	4	X7R	6800 p	±10, ±20	5	200	0.3±0.03	
MSASE063SB7223[FNA01	EMK063 B7223[P-F		X7R	0.01 μ	±10, ±20	5	200	0.3±0.03	
MSASE063SB7152[FNA01	EMK063 B7152[P-F		X7R	1500 p	±10, ±20	5	200	0.3±0.03	
MSASE063SB7222[FNA01	EMK063 B7222[P-F		X7R	2200 p	±10, ±20	5	200	0.3±0.03	
MSASE063SB7332[FNA01	EMK063 B7332[P-F		X7R	3300 p	±10, ±20	5	200	0.3±0.03	
MSASE063SB7472[FNA01	EMK063 B7472[P-F		X7R	4700 p	±10, ±20	5	200	0.3±0.03	
MSASE063SB7682[FNA01	EMK063 B7682[P-F		X7R	6800 p	±10, ±20	5	200	0.3±0.03	
MSASE063SB7103[FNA01	EMK063 B7103[P-F		X7R	0.01 μ	±10, ±20	5	200	0.3±0.03	
MSASE063SB7223[FNA01	EMK063 B7223[P-F		X7R	0.022 μ	±10, ±20	7.5	150	0.3±0.03	

1005TYPE

【Temperature Characteristic B5(BJ) : B(-25~+85°C)/X5R(-55~+85°C)】 0.5mm thickness

New part number	Old part number (for reference)	Rated voltage [V]	Temperature characteristics	Capacitance [F]	Capacitance tolerance [%]	tan δ [%]	HTLT	Thickness ³ [mm]	Note
							Rated voltage x %		
MSASU105SB5223[FNA01	UMK105 BJ223[V-F	50	X5R	0.022 μ	±10, ±20	5	200	0.5±0.05	
MSASU105SB5473[FNA01	UMK105 BJ473[V-F		X5R	0.047 μ	±10, ±20	5	200	0.5±0.05	
MSASU105SB5104[FNA01	UMK105 BJ104[V-F		X5R	0.1 μ	±10, ±20	10	150	0.5±0.05	
MSASU105SB5224[FNA01	UMK105 BJ224[V-F		X5R	0.22 μ	±10, ±20	10	150	0.5±0.05	
MSASU105AB5474[FNA01	UMK105ABJ474[V-F		X5R	0.47 μ	±10, ±20	10	150	0.5±0.10	
MSASU105CB5105[FNA01	UMK105CBJ105[V-F		X5R	1 μ	±10, ±20	10	150	0.5+0.20/-0	
MSASG105SB5104[FNA01	GMK105 BJ104[V-F	35	B	X5R	0.1 μ	±10, ±20	5	150	0.5±0.05
MSASG105AB5105[FNA01	GMK105ABJ105[V-F		X5R	1 μ	±10, ±20	10	150	0.5±0.10	
MSAST105SB5153[FNA01	TMK105 BJ153[V-F	25	B	X5R ⁺	0.015 μ	±10, ±20	3.5	200	0.5±0.05
MSAST105SB5223[FNA01	TMK105 BJ223[V-F		B	X5R ⁺	0.022 μ	±10, ±20	3.5	200	0.5±0.05
MSAST105SB5333[FNA01	TMK105 BJ333[V-F		B	X5R ⁺	0.033 μ	±10, ±20	3.5	150	0.5±0.05
MSAST105SB5473[FNA01	TMK105 BJ473[V-F		B	X5R ⁺	0.047 μ	±10, ±20	3.5	150	0.5±0.05
MSAST105SB5104[FNA01	TMK105 BJ104[V-F		B	X5R	0.1 μ	±10, ±20	5	150	0.5±0.05
MSAST105SB5224[FNA01	TMK105 BJ224[V-F		X5R	0.22 μ	±10, ±20	10	200	0.5±0.05	
MSAST105AB5474[FNA01	TMK105ABJ474[V-F	16	X5R	0.47 μ	±10, ±20	10	200	0.5±0.10	
MSAST105SB5105[FNA01	TMK105 BJ105[V-F		X5R	1 μ	±10, ±20	10	150	0.5±0.05	
MSAST105CB5225[FNA01	TMK105CBJ225[V-F		X5R	2.2 μ	±10, ±20	10	150	0.5+0.20/-0	
MSASE105SB5224[FNA01	EMK105 BJ224[V-F		B	X5R	0.22 μ	±10, ±20	5	150	0.5±0.05
MSASE105AB5474[FNA01	EMK105ABJ474[V-F		X5R	0.47 μ	±10, ±20	10	200	0.5±0.10	
MSASE105SB5105[FNA01	EMK105 BJ105[V-F		X5R	1 μ	±10, ±20	10	150	0.5±0.05	
MSASE105AB5225[FNA01	EMK105ABJ225[V-F	10	X5R	2.2 μ	±10, ±20	10	150	0.5±0.10	
MSASL105SB5225[FNA01	LMK105 BJ225[V-F		X5R	2.2 μ	±10, ±20	10	150	0.5±0.05	
MSASL105BB5475MFNB33	LMK105BBJ475MVLV-F		X5R	4.7 μ	±20	10	150	0.5+0.15/-0.05	
MSASJ105SB5225[FNA01	JMK105 BJ225[V-F		X5R	2.2 μ	±10, ±20	10	150	0.5±0.05	
MSASJ105BB5475MFNA01	JMK105BBJ475MV-F		6.3	X5R	4.7 μ	±20	10	150	0.5+0.15/-0.05
MSASA105EB5226MFNA01	AMK105EBJ226MV-F		4	X5R	2.2 μ	±20	20	150	0.5+0.30/-0

【Temperature Characteristic B5(BJ) : B(-25~+85°C)/X5R(-55~+85°C)】 0.3mm thickness

New part number	Old part number (for reference)	Rated voltage [V]	Temperature characteristics	Capacitance [F]	Capacitance tolerance [%]	tan δ [%]	HTLT	Thickness ³ [mm]	Note
							Rated voltage x %		
MSASU1L3YB5104[FNA01	UMK105 BJ104[P-F	50	X5R	0.1 μ	±10, ±20	10	150	0.3±0.03	
MSAST1L3YB5103[FNA01	TMK105 BJ103[P-F		B	X5R	0.01 μ	±10, ±20	5	150	0.3±0.03
MSAST1L3YB5104[FNA01	TMK105 BJ104[P-F	25	X5R	0.1 μ	±10, ±20	10	150	0.3±0.03	
MSAST1L3YB5224[FNA01	TMK105 BJ224[P-F		X5R	0.22 μ	±10, ±20	10	150	0.3±0.03	
MSAST1L3YB5474[FNA01	TMK105 BJ474[P-F		X5R	0.47 μ	±10, ±20	10	150	0.3±0.03	
MSASE1L3YB5474[FNA01	EMK105 BJ474[P-F		X5R	0.47 μ	±10, ±20	10	150	0.3±0.03	
MSASL1L3YB5105[FNB33	LMK105 BJ105[PLF	10	X5R	1 μ	±10, ±20	10	150	0.3±0.03	
MSASJ1L3YB5105[FNA01	JMK105 BJ105[P-F	6.3	X5R	1 μ	±10, ±20	10	150	0.3±0.03	
MSASA1L3YB5225MFNA01	AMK105 BJ225MP-F	4	X5R	2.2 μ	±20	10	150	0.3±0.03	

▶ This catalog contains the typical specification only due to the limitation of space. When you consider the purchase of our products, please check our specification.
For details of each product (characteristics graph, reliability information, precautions for use, and so on), see our Web site (<http://www.ty-top.com/>).

PART NUMBER

【Temperature Characteristic B5(BJ) : X5R(-55~+85°C)】 0.2mm thickness

New part number	Old part number (for reference)	Rated voltage [V]	Temperature characteristics	Capacitance [F]	Capacitance tolerance [%]	tan δ [%]	HTLT	Thickness ^{*3} [mm]	Note
							Rated voltage x %		
MSASL1L2XB5104[FNA01	LMK105 BJ104[C-F	10	X5R	0.1 μ	±10, ±20	10	150	0.2±0.02	
MSASJ1L2XB5224[FNA01	JMK105 BJ224[C-F	6.3	X5R	0.22 μ	±10, ±20	10	150	0.2±0.02	
MSASJ1L2XB5474[FNA01	JMK105 BJ474[C-F		X5R	0.47 μ	±10, ±20	10	150	0.2±0.02	
MSASJ1L2XB5105MFNA01	JMK105 BJ105MC-F		X5R	1 μ	±20	10	150	0.2±0.02	

【Temperature Characteristic B5(BJ) : X5R(-55~+85°C)】 0.18mm thickness

New part number	Old part number (for reference)	Rated voltage [V]	Temperature characteristics	Capacitance [F]	Capacitance tolerance [%]	tan δ [%]	HTLT	Thickness ^{*3} [mm]	Note
							Rated voltage x %		
MSASL1LEXB5104[RNA01	LMK105 BJ104[E-R	10	X5R	0.1 μ	±10, ±20	10	150	0.18±0.02	
MSASJ1LEXB5224[RNA01	JMK105 BJ224[E-R	6.3	X5R	0.22 μ	±10, ±20	10	150	0.18±0.02	
MSASJ1LEXB5474[RNA01	JMK105 BJ474[E-R		X5R	0.47 μ	±10, ±20	10	150	0.18±0.02	
MSASA1LEXB5105MRNA01	AMK105 BJ105ME-R	4	X5R	1 μ	±20	10	150	0.18±0.02	

【Temperature Characteristic B5(BJ) : X5R(-55~+85°C)】 0.13mm thickness

New part number	Old part number (for reference)	Rated voltage [V]	Temperature characteristics	Capacitance [F]	Capacitance tolerance [%]	tan δ [%]	HTLT	Thickness ^{*3} [mm]	Note
							Rated voltage x %		
MSASL1LHXB5104MRNA01	LMK105 BJ104MH-R	10	X5R	0.1 μ	±20	10	150	0.13±0.02	
MSASJ1LHXB5224MRNA01	JMK105 BJ224MH-R	6.3	X5R	0.22 μ	±20	10	150	0.13±0.02	
MSASA1LHXB5474MRNA01	AMK105 BJ474MH-R	4	X5R	0.47 μ	±20	10	150	0.13±0.02	

【Temperature Characteristic C6 : X6S(-55~+105°C)】 0.5mm thickness

New part number	Old part number (for reference)	Rated voltage [V]	Temperature characteristics	Capacitance [F]	Capacitance tolerance [%]	tan δ [%]	HTLT	Thickness ^{*3} [mm]	Note
							Rated voltage x %		
MSASG105CC6105[FNA01	GMK105CC6105[V-F	35	X6S	1 μ	±10, ±20	10	150	0.5+0.20/-0	
MSAST105AC6105[FNA01	TMK105AC6105[V-F	25	X6S	1 μ	±10, ±20	10	150	0.5±0.10	
MSAST105CC6105MFNA01	TMK105CC6105MV-F		X6S	1 μ	±20	10	150	0.5+0.20/-0	
MSASE105SC6105[FNA01	EMK105 C6105[V-F	16	X6S	1 μ	±10, ±20	10	150	0.5±0.05	
MSASE105CC6225[FNA01	EMK105CC6225[V-F		X6S	2.2 μ	±10, ±20	10	150	0.5+0.20/-0	
MSASL105SC6105[FNA01	LMK105 C6105[V-F	10	X6S	1 μ	±10, ±20	10	200	0.5±0.05	
MSASL105AC6225[FNA01	LMK105AC6225[V-F		X6S	2.2 μ	±10, ±20	10	150	0.5±0.10	
MSASJ105SC6225[FNA01	JMK105 C6225[V-F	6.3	X6S	2.2 μ	±10, ±20	10	150	0.5±0.05	
MSASJ105BC6475MFNA01	JMK105BC6475MV-F		X6S	4.7 μ	±20	10	150	0.5+0.15/-0.05	
MSASA105BC6475MFNA01	AMK105BC6475MV-F	4	X6S	4.7 μ	±20	10	200	0.5+0.15/-0.05	
MSASP105EC6226MFNA01	PMK105EC6226MV-F	2.5	X6S	2.2 μ	±20	20	150	0.5+0.30/-0	

【Temperature Characteristic B7 : X7R(-55~+125°C)】 0.5mm thickness

New part number	Old part number (for reference)	Rated voltage [V]	Temperature characteristics	Capacitance [F]	Capacitance tolerance [%]	tan δ [%]	HTLT	Thickness ^{*3} [mm]	Note	
							Rated voltage x %			
MSASU105SB7152[FNA01	UMK105 B7152[V-F	50	X7R	1500 p	±10, ±20	2.5	200	0.5±0.05		
MSASU105SB7222[FNA01	UMK105 B7222[V-F		X7R	2200 p	±10, ±20	2.5	200	0.5±0.05		
MSASU105SB7332[FNA01	UMK105 B7332[V-F		X7R	3300 p	±10, ±20	2.5	200	0.5±0.05		
MSASU105SB7472[FNA01	UMK105 B7472[V-F		X7R	4700 p	±10, ±20	2.5	150	0.5±0.05		
MSASU105SB7682[FNA01	UMK105 B7682[V-F		X7R	6800 p	±10, ±20	2.5	150	0.5±0.05		
MSASU105SB7103[FNA01	UMK105 B7103[V-F		X7R	0.01 μ	±10, ±20	3.5	150	0.5±0.05		
MSASU105SB7223[FNB25	UMK105 B7223[V-FR		X7R	0.022 μ	±10, ±20	10	200	0.5±0.05		
MSASU105SB7473[FNB25	UMK105 B7473[V-FR		X7R	0.047 μ	±10, ±20	10	200	0.5±0.05		
MSASU105SB7104[FNB25	UMK105 B7104[V-FR		X7R	0.1 μ	±10, ±20	10	150	0.5±0.05		
MSAST105SB7223[FNA01	TMK105 B7223[V-F		25	X7R	0.022 μ	±10, ±20	3.5	150	0.5±0.05	
MSAST105SB7473[FNA01	TMK105 B7473[V-F			X7R	0.047 μ	±10, ±20	3.5	150	0.5±0.05	
MSAST105SB7104[FNB25	TMK105 B7104[V-FR			X7R	0.1 μ	±10, ±20	10	200	0.5±0.05	
MSAST105SB7224[FNB25	TMK105 B7224[V-FR	16	X7R	0.22 μ	±10, ±20	10	150	0.5±0.05		
MSASE105SB7223[FNA01	EMK105 B7223[V-F		X7R	0.022 μ	±10, ±20	3.5	200	0.5±0.05		
MSASE105SB7473[FNA01	EMK105 B7473[V-F		X7R	0.047 μ	±10, ±20	3.5	200	0.5±0.05		
MSASE105SB7104[FNA01	EMK105 B7104[V-F	10	X7R	0.1 μ	±10, ±20	5	150	0.5±0.05		
MSASE105SB7224[FNB25	EMK105 B7224[V-FR		X7R	0.22 μ	±10, ±20	10	150	0.5±0.05		
MSASL105SB7224[FNB25	LMK105 B7224[V-FR		X7R	0.22 μ	±10, ±20	10	150	0.5±0.05		
MSASL105SB7474[FNA01	LMK105 B7474[V-F	6.3	X7R	0.47 μ	±10, ±20	10	150	0.5±0.05		
MSASJ105SB7224[FNA01	JMK105 B7224[V-F		X7R	0.22 μ	±10, ±20	5	150	0.5±0.05		
MSASJ105SB7474[FNA01	JMK105 B7474[V-F	X7R	0.47 μ	±10, ±20	10	150	0.5±0.05			

* This catalog contains the typical specification only due to the limitation of space. When you consider the purchase of our products, please check our specification.
For details of each product (characteristics graph, reliability information, precautions for use, and so on), see our Web site (<http://www.ty-top.com/>).

PART NUMBER

1608TYPE

【Temperature Characteristic B5(BJ) : X5R(−55~+85°C)】 0.8mm thickness

New part number	Old part number (for reference)	Rated voltage [V]	Temperature characteristics	Capacitance [F]	Capacitance tolerance [%]	tan δ [%]	HTLT	Thickness ^{*3} [mm]	Note
							Rated voltage x %		
MSASU168AB5474□TNA01	UMK107ABJ474□A-T	50	X5R	0.47 μ	±10, ±20	10	150	0.8±0.15/-0.05	
MSASU168SB5105□TNA01	UMK107 BJ105□A-T		X5R	1 μ	±10, ±20	10	150	0.8±0.10	
MSASU168BB5225□TNA01	UMK107BBJ225□A-T		X5R	2.2 μ	±10, ±20	10	150	0.8±0.20/-0	
MSASG168BB5475□TNA01	GMK107BBJ475□A-T	35	X5R	4.7 μ	±10, ±20	10	150	0.8±0.20/-0	
MSAST168AB5225□TNA01	TMK107ABJ225□A-T	25	X5R	2.2 μ	±10, ±20	10	150	0.8±0.15/-0.05	
MSAST168BB5475□TNA01	TMK107BBJ475□A-T		X5R	4.7 μ	±10, ±20	10	150	0.8±0.20/-0	
MSAST168BB5106MTNA01	TMK107BBJ106MA-T		X5R	10 μ	±20	10	150	0.8±0.20/-0	
MSASE168AB5475□TNA01	EMK107ABJ475□A-T	16	X5R	4.7 μ	±10, ±20	10	150	0.8±0.15/-0.05	
MSASE168BB5106MTNA01	EMK107BBJ106MA-T		X5R	10 μ	±20	10	150	0.8±0.20/-0	
MSASL168BB5106□TNB33	LMK107BBJ106□ALT		X5R	10 μ	±10, ±20	10	150	0.8±0.20/-0	
MSASL168BB5226MTNA01	LMK107BBJ226MA-T	10	X5R	22 μ	±20	10	150	0.8±0.20/-0	
MSASJ168AB5106□TNA01	JMK107ABJ106□A-T	6.3	X5R	10 μ	±10, ±20	10	150	0.8±0.15/-0.05	
MSASJ168BB5226MTNA01	JMK107BBJ226MA-T		X5R	22 μ	±20	10	150	0.8±0.20/-0	
MSASJ168BB5476MRCA01	JMK107BBJ476MA-RE		X5R	47 μ	±20	15	150	0.8±0.20/-0	
MSASA168BB5476MRCA01	AMK107BBJ476MA-RE	4	X5R	47 μ	±20	20	150	0.8±0.20/-0	

【Temperature Characteristic B5(BJ) : X5R(−55~+85°C)】 0.45mm thickness

New part number	Old part number (for reference)	Rated voltage [V]	Temperature characteristics	Capacitance [F]	Capacitance tolerance [%]	tan δ [%]	HTLT	Thickness ^{*3} [mm]	Note
							Rated voltage x %		
MSAST16KTB5105□TNA01	TMK107 BJ105□K-T	25	X5R	1 μ	±10, ±20	10	150	0.45±0.05	
MSASE16KTB5105□TNA01	EMK107 BJ105□K-T	16	X5R	1 μ	±10, ±20	10	150	0.45±0.05	
MSASE16KJB5225□TNA01	EMK107BBJ225□K-T		X5R	2.2 μ	±10, ±20	10	150	0.45±0.05	
MSASL16KTB5105□TNA01	LMK107 BJ105□K-T	10	X5R	1 μ	±10, ±20	10	150	0.45±0.05	
MSASL16KTB5225□TNA01	LMK107 BJ225□K-T		X5R	2.2 μ	±10, ±20	10	150	0.45±0.05	
MSASL16KJB5475MTNB33	LMK107BBJ475MKLT		X5R	4.7 μ	±20	10	150	0.45±0.05	
MSASJ16KTB5105□TNA01	JMK107 BJ105□K-T	6.3	X5R	1 μ	±10, ±20	10	150	0.45±0.05	
MSASJ16KTB5225□TNA01	JMK107 BJ225□K-T		X5R	2.2 μ	±10, ±20	10	150	0.45±0.05	
MSASJ16KTB5475MTNA01	JMK107 BJ475MK-T		X5R	4.7 μ	±20	10	150	0.45±0.05	
MSASJ16KJB5106MTNC12	JMK107BBJ106MK-TT		X5R	10 μ	±20	10	150	0.45±0.05	

【Temperature Characteristic C6 : X6S(−55~+105°C)】 0.8mm thickness

New part number	Old part number (for reference)	Rated voltage [V]	Temperature characteristics	Capacitance [F]	Capacitance tolerance [%]	tan δ [%]	HTLT	Thickness ^{*3} [mm]	Note
							Rated voltage x %		
MSAST168BC6225□TNA01	TMK107BC6225□A-T	25	X6S	2.2 μ	±10, ±20	10	150	0.8±0.20/-0	
MSASE168SC6105□TNA01	EMK107 C6105□A-T	16	X6S	1 μ	±10, ±20	5	150	0.8±0.10	
MSASE168BC6225□TNA01	EMK107BC6225□A-T		X6S	2.2 μ	±10, ±20	10	150	0.8±0.20/-0	
MSASE168BC6475□TNA01	EMK107BC6475□A-T		X6S	4.7 μ	±10, ±20	10	150	0.8±0.20/-0	
MSASE168BC6106MTNA01	EMK107BC6106MA-T	10	X6S	10 μ	±20	10	150	0.8±0.20/-0.0	
MSASL168SC6105□TNA01	LMK107 C6105□A-T		X6S	1 μ	±10, ±20	5	150	0.8±0.10	
MSASL168AC6475□TNA01	LMK107AC6475□A-T		X6S	4.7 μ	±10, ±20	10	150	0.8±0.15/-0.05	
MSASL168BC6106MTNA01	LMK107BC6106MA-T	6.3	X6S	10 μ	±20	10	150	0.8±0.20/-0	
MSASJ168SC6475□TNA01	JMK107 C6475□A-T		X6S	4.7 μ	±10, ±20	10	150	0.8±0.10	
MSASJ168BC6106MTNA01	JMK107BC6106MA-T		X6S	10 μ	±20	10	150	0.8±0.20/-0	
MSASJ168BC6226MTNA01	JMK107BC6226MA-T		X6S	22 μ	±20	10	150	0.8±0.20/-0	
MSASA168BC6226MTNA01	AMK107BC6226MA-T	4	X6S	22 μ	±20	10	150	0.8±0.20/-0	
MSASA168BC6476MRCA01	AMK107BC6476MA-RE		X6S	47 μ	±20	20	150	0.8±0.20/-0	

【Temperature Characteristic B7 : X7R(−55~+125°C)】 0.8mm thickness

New part number	Old part number (for reference)	Rated voltage [V]	Temperature characteristics	Capacitance [F]	Capacitance tolerance [%]	tan δ [%]	HTLT	Thickness ^{*3} [mm]	Note
							Rated voltage x %		
MSASU168SB7224□TNB25	UMK107 B7224□A-TR	50	X7R	0.22 μ	±10, ±20	10	150	0.8±0.10	
MSASU168SB7474□TNB25	UMK107 B7474□A-TR		X7R	0.47 μ	±10, ±20	10	150	0.8±0.10	
MSASU168AB7105□TNA01	UMK107AB7105□A-T		X7R	1 μ	±10, ±20	10	150	0.8±0.15/-0.05	
MSAST168SB7474□TNB25	TMK107 B7474□A-TR	25	X7R	0.47 μ	±10, ±20	10	150	0.8±0.10	
MSAST168SB7105□TNA01	TMK107 B7105□A-T		X7R	1 μ	±10, ±20	10	150	0.8±0.10	
MSASE168SB7474□TNA01	EMK107 B7474□A-T	16	X7R	0.47 μ	±10, ±20	3.5	150	0.8±0.10	
MSASE168SB7105□TNA01	EMK107 B7105□A-T		X7R	1 μ	±10, ±20	5	150	0.8±0.10	
MSASE168BB7225□TNA01	EMK107BB7225□A-T		X7R	2.2 μ	±10, ±20	10	150	0.8±0.20/-0	
MSASL168SB7225□TNB25	LMK107 B7225□A-TR	10	X7R	2.2 μ	±10, ±20	10	150	0.8±0.10	
MSASJ168SB7225□TNB25	JMK107 B7225□A-TR	6.3	X7R	2.2 μ	±10, ±20	10	200	0.8±0.10	
MSASJ168BB7475□TNA01	JMK107BB7475□A-T		X7R	4.7 μ	±10, ±20	10	150	0.8±0.20/-0	

* This catalog contains the typical specification only due to the limitation of space. When you consider the purchase of our products, please check our specification.
For details of each product (characteristics graph, reliability information, precautions for use, and so on), see our Web site (<http://www.ty-top.com/>).

PART NUMBER

2012TYPE

【Temperature Characteristic B5(BJ) : X5R(-55~+85°C)】 1.25mm thickness

New part number	Old part number (for reference)	Rated voltage [V]	Temperature characteristics	Capacitance [F]	Capacitance tolerance [%]	tan δ [%]	HHLT		Thickness ^{※3} [mm]	Note
							Rated voltage x %			
MSASU21GGB5475□TNA01	UMK212BBJ475□G-T	50	X5R	4.7 μ	±10, ±20	10	150	1.25+0.20/-0		
MSASG21GGB5106□TNA01	GMK212BBJ106□G-T	35	X5R	10 μ	±10, ±20	10	150	1.25+0.20/-0		
MSAST21GAB5475□TNA01	TMK212ABJ475□G-T	25	X5R	4.7 μ	±10, ±20	10	150	1.25+0.15/-0.05		
MSAST21GGB5106□TNA01	TMK212BBJ106□G-T		X5R	10 μ	±10, ±20	10	150	1.25+0.20/-0		
MSAST21GGB5226MTNC12	TMK212BBJ226MG-TT	16	X5R	22 μ	±20	10	150	1.25+0.20/-0		
MSASE21GAB5106□TNA01	EMK212ABJ106□G-T		X5R	10 μ	±10, ±20	10	150	1.25+0.15/-0.05		
MSASE21GGB5226MTNA01	EMK212BBJ226MG-T	X5R	22 μ	±20	10	150	1.25+0.20/-0			
MSASL21GGB5226MTNA01	LMK212BBJ226MG-T	10	X5R	22 μ	±20	10	150	1.25+0.20/-0		
MSASL21GGB5476MTNA01	LMK212BBJ476MG-T		X5R	47 μ	±20	10	150	1.25+0.20/-0		
MSASJ21GAB5226□TNA01	JMK212ABJ226□G-T	6.3	X5R	22 μ	±10, ±20	10	150	1.25+0.15/-0.05		
MSASJ21GGB5476MTNA01	JMK212BBJ476MG-T		X5R	47 μ	±20	10	150	1.25+0.20/-0		
MSASJ21GGB5107MTCA01	JMK212BBJ107MG-TE	4	X5R	100 μ	±20	20	150	1.25+0.20/-0		
MSASA21GGB5107MTCA01	EMK212BBJ107MG-TE		X5R	100 μ	±20	20	150	1.25+0.20/-0		
MSASP21GGB5107MTNA01	PMK212BBJ107MG-T	2.5	X5R	100 μ	±20	10	150	1.25+0.20/-0		

【Temperature Characteristic B5(BJ) : B(-25~+85°C)/X5R(-55~+85°C)】 0.85mm thickness

New part number	Old part number (for reference)	Rated voltage [V]	Temperature characteristics	Capacitance [F]	Capacitance tolerance [%]	tan δ [%]	HHLT		Thickness ^{※3} [mm]	Note
							Rated voltage x %			
MSASU219JB5105□TNA01	UMK212ABJ105□D-T	50	X5R	1 μ	±10, ±20	10	150	0.85±0.10		
MSASU219LB5225□TNA01	UMK212BBJ225□D-T		X5R	2.2 μ	±10, ±20	10	150	0.85±0.10		
MSASG219LB5475□TNA01	GMK212BBJ475□D-T	35	X5R	4.7 μ	±10, ±20	10	150	0.85±0.10		
MSAST219SB5474□TNA01	TMK212 B J474□D-T		B X5R	0.47 μ	±10, ±20	3.5	200	0.85±0.10		
MSAST219SB5105□TNA01	TMK212 B J105□D-T	25	B X5R	1 μ	±10, ±20	5	200	0.85±0.10		
MSAST219JB5225□TNA01	TMK212ABJ225□D-T		X5R	2.2 μ	±10, ±20	5	150	0.85±0.10		
MSAST219LB5475□TNA01	TMK212BBJ475□D-T	16	X5R	4.7 μ	±10, ±20	10	150	0.85±0.10		
MSAST219LB5106□TNA01	TMK212BBJ106□D-T		X5R	10 μ	±10, ±20	10	150	0.85±0.10		
MSASE219SB5105□TNA01	EMK212 B J105□D-T	10	B X5R ^{※1}	1 μ	±10, ±20	5	200	0.85±0.10		
MSASE219JB5225□TNA01	EMK212ABJ225□D-T		B X5R ^{※1}	2.2 μ	±10, ±20	5	200	0.85±0.10		
MSASE219SB5475□TNA01	EMK212 B J475□D-T	6.3	B X5R	4.7 μ	±10, ±20	10	150	0.85±0.10		
MSASE219JB5106□TNA01	EMK212ABJ106□D-T		B X5R	10 μ	±10, ±20	10	150	0.85±0.10		
MSASL219SB5105□TNA01	LMK212 B J105□D-T	10	B X5R ^{※1}	1 μ	±10, ±20	3.5	200	0.85±0.10		
MSASL219SB5225□TNA01	LMK212 B J225□D-T		B X5R ^{※1}	2.2 μ	±10, ±20	5	200	0.85±0.10		
MSASL219JB5106□TNA01	LMK212ABJ106□D-T	6.3	X5R	10 μ	±10, ±20	10	150	0.85±0.10		
MSASL219LB5226MTNA01	LMK212BBJ226MD-T		X5R	22 μ	±20	10	150	0.85±0.10		
MSASJ219JB5106□TNA01	JMK212ABJ106□D-T	4	X5R	10 μ	±10, ±20	10	200	0.85±0.10		
MSASJ219JB5226MTNA01	JMK212ABJ226MD-T		X5R	22 μ	±20	10	150	0.85±0.10		
MSASA219LB5476MTNA01	AMK212BBJ476MD-T	4	X5R	47 μ	±20	10	150	0.85±0.10		

【Temperature Characteristic X6S(-55~+105°C)】 1.25mm thickness

New part number	Old part number (for reference)	Rated voltage [V]	Temperature characteristics	Capacitance [F]	Capacitance tolerance [%]	tan δ [%]	HHLT		Thickness ^{※3} [mm]	Note
							Rated voltage x %			
MSAST21GBC6106□TNA01	TMK212BC6106□G-T	25	X6S	10 μ	±10, ±20	10	150	1.25+0.20/-0		
MSASE21GBC6226MTNC12	EMK212BC6226MG-TT	16	X6S	22 μ	±20	10	150	1.25+0.20/-0		
MSASL21GBC6226MTNA01	LMK212BC6226MG-T	10	X6S	22 μ	±20	10	150	1.25+0.20/-0		
MSASJ21GBC6226MTNA01	JMK212BC6226MG-T	6.3	X6S	22 μ	±20	10	150	1.25+0.20/-0		
MSASJ21GBC6476MTNA01	JMK212BC6476MG-T		X6S	47 μ	±20	10	150	1.25+0.20/-0		
MSASA21GAC6226MTNA01	AMK212AC6226MG-T	4	X6S	22 μ	±20	10	150	1.25+0.15/-0.05		
MSASA21GBC6476MTNA01	AMK212BC6476MG-T		X6S	47 μ	±20	10	150	1.25+0.20/-0		
MSASA21GBC6107MTCA01	AMK212BC6107MG-TE		X6S	100 μ	±20	20	150	1.25+0.20/-0		

【Temperature Characteristic C6 : X6S(-55~+105°C)】 0.85mm thickness

New part number	Old part number (for reference)	Rated voltage [V]	Temperature characteristics	Capacitance [F]	Capacitance tolerance [%]	tan δ [%]	HHLT		Thickness ^{※3} [mm]	Note
							Rated voltage x %			
MSASL219JC6106□TNA01	LMK212AC6106□D-T	10	X6S	10 μ	±10, ±20	10	150	0.85±0.10		
MSASA219LC6226MTNA01	AMK212BC6226MD-T	4	X6S	22 μ	±20	10	150	0.85±0.10		

【Temperature Characteristic B7 : X7R(-55~+125°C)】 1.25mm thickness

New part number	Old part number (for reference)	Rated voltage [V]	Temperature characteristics	Capacitance [F]	Capacitance tolerance [%]	tan δ [%]	HHLT		Thickness ^{※3} [mm]	Note
							Rated voltage x %			
MSASU21GSB7224□TNA01	UMK212 B7224□G-T	50	X7R	0.22 μ	±10, ±20	3.5	150	1.25±0.10		
MSASU21GSB7474□TNA01	UMK212 B7474□G-T		X7R	0.47 μ	±10, ±20	3.5	150	1.25±0.10		
MSASU21GSB7105□TNA01	UMK212 B7105□G-T	35	X7R	1 μ	±10, ±20	10	150	1.25±0.10		
MSASU21GGB7225□TNA01	UMK212BB7225□G-T		X7R	2.2 μ	±10, ±20	10	150	1.25+0.20/-0		
MSASG21GSB7105□TNA01	GMK212 B7105□G-T	25	X7R	1 μ	±10, ±20	10	150	1.25±0.10		
MSAST21GSB7225□TNB25	TMK212 B7225□G-TR		X7R	2.2 μ	±10, ±20	10	150	1.25±0.10		
MSAST21GAB7475□TNA01	TMK212AB7475□G-T	16	X7R	4.7 μ	±10, ±20	10	150	1.25+0.15/-0.05		
MSASE21GSB7475□TNA01	EMK212 B7475□G-T		X7R	4.7 μ	±10, ±20	10	150	1.25±0.10		
MSASE21GGB7106MTNA01	EMK212BB7106MG-T	10	X7R	10 μ	±20	10	150	1.25+0.20/-0		
MSASL21GAB7106□TNA01	LMK212AB7106□G-T		X7R	10 μ	±10, ±20	10	150	1.25+0.15/-0.05		
MSASJ21GAB7106□TNA01	JMK212AB7106□G-T	6.3	X7R	10 μ	±10, ±20	10	150	1.25+0.15/-0.05		

PART NUMBER

【Temperature Characteristic B7 : X7R(-55~+125°C)】 0.85mm thickness

New part number	Old part number (for reference)	Rated voltage [V]	Temperature characteristics		Capacitance [F]	Capacitance tolerance [%]	tan δ [%]	HTLT	Thickness ^{*3} [mm]	Note
								Rated voltage x %		
MSASU219JB7104□TNA01	UMK212AB7104□D-T	50		X7R	0.1 μ	±10, ±20	10	150	0.85±0.10	
MSASU219JB7224□TNA01	UMK212AB7224□D-T			X7R	0.22 μ	±10, ±20	10	150	0.85±0.10	
MSASU219JB7474□TNA01	UMK212AB7474□D-T			X7R	0.47 μ	±10, ±20	10	150	0.85±0.10	
MSASU219JB7105□TNA01	UMK212AB7105□D-T			X7R	1 μ	±10, ±20	10	150	0.85±0.10	
MSAST219JB7225□TNB25	TMK212AB7225□D-TR	25		X7R	2.2 μ	±10, ±20	10	150	0.85±0.10	
MSASE219SB7474□TNA01	EMK212 B7474□D-T	16		X7R	0.47 μ	±10, ±20	3.5	200	0.85±0.10	
MSASE219SB7105□TNA01	EMK212 B7105□D-T			X7R	1 μ	±10, ±20	5	200	0.85±0.10	
MSASE219JB7225□TNA01	EMK212AB7225□D-T			X7R	2.2 μ	±10, ±20	5	150	0.85±0.10	
MSASE219LB7475MTNA01	EMK212BB7475MD-T			X7R	4.7 μ	±20	10	150	0.85±0.10	
MSASL219SB7105□TNA01	EMK212 B7105□D-T	10		X7R	1 μ	±10, ±20	3.5	200	0.85±0.10	
MSASL219JB7225□TNA01	LMK212AB7225□D-T			X7R	2.2 μ	±10, ±20	5	200	0.85±0.10	
MSASL219JB7475□TNB25	LMK212AB7475□D-TR			X7R	4.7 μ	±10, ±20	10	150	0.85±0.10	

3216TYPE

【Temperature Characteristic B5(BJ) : X5R(-55~+85°C)】 1.6mm thickness

New part number	Old part number (for reference)	Rated voltage [V]	Temperature characteristics		Capacitance [F]	Capacitance tolerance [%]	tan δ [%]	HTLT	Thickness ^{*3} [mm]	Note
								Rated voltage x %		
MSASU31LSB5475□TNA01	UMK316 BJ475□L-T	50		X5R	4.7 μ	±10, ±20	10	150	1.6±0.20	
MSASU31LBB5106□TNA01	UMK316BBJ106□L-T			X5R	10 μ	±10, ±20	10	150	1.6±0.30	
MSAST31LBB5226MTNA01	TMK316BBJ226ML-T	25		X5R	22 μ	±20	10	150	1.6±0.30	
MSASE31LBB5476MTNA01	EMK316BBJ476ML-T	16		X5R	4.7 μ	±20	10	150	1.6±0.30	
MSASL31LAB5476MTNA01	LMK316ABJ476ML-T	10		X5R	4.7 μ	±20	10	150	1.6±0.20	
MSASJ31LAB5107MTNA01	JMK316ABJ107ML-T	6.3		X5R	100 μ	±20	10	150	1.6±0.20	
MSASJ31LBB5227MTCA01	JMK316BBJ227ML-TE			X5R	220 μ	±20	20	150	1.6±0.30	
MSASA31LAB5107MTNA01	AMK316ABJ107ML-T	4		X5R	100 μ	±20	10	150	1.6±0.20	
MSASA31LBB5157MTNA01	AMK316BBJ157ML-T			X5R	150 μ	±20	10	150	1.6±0.30	
MSASA31LBB5227MTCA01	AMK316BBJ227ML-TE			X5R	220 μ	±20	20	150	1.6±0.30	
MSASP31LBB5227MTNA01	PMK316BBJ227ML-T	2.5		X5R	220 μ	±20	10	150	1.6±0.30	

【Temperature Characteristic B5(BJ) : B(-25~+85°C)/X5R(-55~+85°C)】 0.85mm thickness

New part number	Old part number (for reference)	Rated voltage [V]	Temperature characteristics		Capacitance [F]	Capacitance tolerance [%]	tan δ [%]	HTLT	Thickness ^{*3} [mm]	Note
								Rated voltage x %		
MSASU319HB5105□TNA01	UMK316 BJ105□D-T	50		B	X5R	1 μ	±10, ±20	3.5	150	0.85±0.10
MSASU319HB5225□TNA01	UMK316 BJ225□D-T			B	X5R	2.2 μ	±10, ±20	3.5	150	0.85±0.10
MSASU319LB5475□TNA01	UMK316ABJ475□D-T			X5R	4.7 μ	±10, ±20	10	150	0.85±0.10	
MSAST319HB5105□TNA01	TMK316 BJ105□D-T			B	X5R	1 μ	±10, ±20	3.5	200	0.85±0.10
MSAST319HB5225□TNA01	TMK316 BJ225□D-T	25		B	X5R	2.2 μ	±10, ±20	3.5	150	0.85±0.10
MSAST319HB5475□TNA01	TMK316 BJ475□D-T			X5R	4.7 μ	±10, ±20	5	150	0.85±0.10	
MSAST319LB5106□TNA01	TMK316ABJ106□D-T			X5R	10 μ	±10, ±20	10	150	0.85±0.10	
MSASE319HB5225□TNA01	EMK316 BJ225□D-T	16		B	X5R	2.2 μ	±10, ±20	3.5	200	0.85±0.10
MSASE319HB5475□TNA01	EMK316 BJ475□D-T			B	X5R	4.7 μ	±10, ±20	5	200	0.85±0.10
MSASE319HB5106□TNA01	EMK316 BJ106□D-T			X5R	10 μ	±10, ±20	10	150	0.85±0.10	
MSASE319LB5226MTNA01	EMK316ABJ226MD-T			X5R	22 μ	±20	10	150	0.85±0.10	
MSASL319HB5475□TNA01	LMK316 BJ475□D-T	10		B	X5R	4.7 μ	±10, ±20	5	200	0.85±0.10
MSASL319HB5106□TNA01	LMK316 BJ106□D-T			X5R	10 μ	±10, ±20	10	200	0.85±0.10	
MSASL319LB5226MTNA01	LMK316ABJ226MD-T			X5R	22 μ	±20	10	150	0.85±0.10	
MSASJ319HB5106□TNA01	JMK316 BJ106□D-T	6.3		X5R	10 μ	±10, ±20	10	200	0.85±0.10	
MSASJ319LB5226MTNA01	JMK316ABJ226MD-T			X5R	22 μ	±20	10	150	0.85±0.10	
MSASJ319LB5476MTNA01	JMK316ABJ476MD-T			X5R	4.7 μ	±20	10	150	0.85±0.10	

【Temperature Characteristic C6 : X6S(-55~+105°C)】 1.6mm thickness

New part number	Old part number (for reference)	Rated voltage [V]	Temperature characteristics		Capacitance [F]	Capacitance tolerance [%]	tan δ [%]	HTLT	Thickness ^{*3} [mm]	Note
								Rated voltage x %		
MSAST31LBC6226MTNA01	TMK316BC6226ML-T	25		X6S	22 μ	±20	10	150	1.6±0.30	
MSASE31LBC6226MTNA01	EMK316BC6226ML-T	16		X6S	22 μ	±20	10	150	1.6±0.30	
MSASL31LBC6476MTNA01	LMK316BC6476ML-T	10		X6S	4.7 μ	±20	10	150	1.6±0.30	
MSASJ31LAC6476MTNA01	JMK316AC6476ML-T	6.3		X6S	4.7 μ	±20	10	150	1.6±0.20	
MSASA31LAC6476MTNA01	AMK316AC6476ML-T			X6S	4.7 μ	±20	10	200	1.6±0.20	
MSASA31LAC6107MTNA01	AMK316AC6107ML-T	4		X6S	100 μ	±20	10	150	1.6±0.20	
MSASA31LBC6227MTCA01	AMK316BC6227ML-TE			X6S	220 μ	±20	20	150	1.6±0.30	

【Temperature Characteristic C7 : X7S(-55~+125°C)】 1.6mm thickness

New part number	Old part number (for reference)	Rated voltage [V]	Temperature characteristics		Capacitance [F]	Capacitance tolerance [%]	tan δ [%]	HTLT	Thickness ^{*3} [mm]	Note
								Rated voltage x %		
MSASJ31LAC7476MTNA01	JMK316AC7476ML-T	6.3		X7S	4.7 μ	±20	10	150	1.6±0.20	
MSASA31LAC7476MTNA01	AMK316AC7476ML-T	4		X7S	4.7 μ	±20	10	150	1.6±0.20	

▶ This catalog contains the typical specification only due to the limitation of space. When you consider the purchase of our products, please check our specification.
For details of each product (characteristics graph, reliability information, precautions for use, and so on), see our Web site (<http://www.ty-top.com/>).

PART NUMBER

【Temperature Characteristic B7 : X7R(-55~+125°C)】 1.6mm thickness

New part number	Old part number (for reference)	Rated voltage [V]	Temperature characteristics	Capacitance [F]	Capacitance tolerance [%]	tan δ [%]	HTLT	Thickness ^{*3} [mm]	Note
							Rated voltage x %		
MSASU31LSB7225□TNA01	UMK316 B7225□L-T	50	X7R	2.2 μ	±10, ±20	10	150	1.6±0.20	
MSASU31LAB7475□TNA01	UMK316AB7475□L-T			4.7 μ	±10, ±20	10	150	1.6±0.20	
MSASG31LAB7106□TNB25	GMK316AB7106□L-TR	35	X7R	10 μ	±10, ±20	10	150	1.6±0.20	
MSAST31LAB7475□TNA01	TMK316AB7475□L-T			4.7 μ	±10, ±20	10	200	1.6±0.20	
MSAST31LAB7106□TNA01	TMK316AB7106□L-T	25	X7R	10 μ	±10, ±20	10	150	1.6±0.20	
MSASE31LSB7475□TNA01	EMK316 B7475□L-T			4.7 μ	±10, ±20	5	200	1.6±0.20	
MSASE31LAB7106□TNA01	EMK316AB7106□L-T	16	X7R	10 μ	±10, ±20	10	200	1.6±0.20	
MSASE31LBB7226MTNA01	EMK316BB7226ML-T			22 μ	±20	10	150	1.6±0.30	
MSASL31LAB7106□TNA01	LMK316AB7106□L-T	10	X7R	10 μ	±10, ±20	10	200	1.6±0.20	
MSASL31LAB7226□TNB25	LMK316AB7226□L-TR			22 μ	±10, ±20	10	150	1.6±0.20	

【Temperature Characteristic B7 : X7R(-55~+125°C)】 0.85mm thickness

New part number	Old part number (for reference)	Rated voltage [V]	Temperature characteristics	Capacitance [F]	Capacitance tolerance [%]	tan δ [%]	HTLT	Thickness ^{*3} [mm]	Note
							Rated voltage x %		
MSASU319HB7225□TNA01	UMK316 B7225□D-T	50	X7R	2.2 μ	±10, ±20	10	150	0.85±0.10	
MSAST319LB7475□TNA01	TMK316AB7475□D-T	25	X7R	4.7 μ	±10, ±20	10	150	0.85±0.10	
MSASL319LB7106MTNA01	LMK316AB7106MD-T	10	X7R	10 μ	±20	10	150	0.85±0.10	

3225TYPE

【Temperature Characteristic B5(BJ) : B(-25~+85°C)/X5R(-55~+85°C)】 2.5mm thickness

New part number	Old part number (for reference)	Rated voltage [V]	Temperature characteristics	Capacitance [F]	Capacitance tolerance [%]	tan δ [%]	HTLT	Thickness ^{*3} [mm]	Note
							Rated voltage x %		
MSASU32MSB5106□PNA01	UMK325 BJ106□M-P	50	X5R	10 μ	±10, ±20	5	150	2.5±0.20	
MSASG32MSB5226MPNA01	GMK325 BJ226MM-P	35	X5R	22 μ	±20	5	150	2.5±0.20	
MSAST32MAB5476MPNDT1	TMK325ABJ476MM-P	25	X5R	47 μ	±20	10	150	2.5±0.30	
MSASE32MAB5107MPNA01	EMK325ABJ107MM-P	16	X5R	100 μ	±20	10	150	2.5±0.30	
MSASL32MAB5107MPNA01	LMK325ABJ107MM-P	10	X5R	100 μ	±20	10	150	2.5±0.30	
MSASJ32MAB5157MPNDT1	JMK325ABJ157MM-P	6.3	X5R	150 μ	±20	10	150	2.5±0.30	
MSASJ32MAB5227MPNDT1	JMK325ABJ227MM-P		X5R	220 μ	±20	10	150	2.5±0.30	
MSASJ32MAB5337MPNDT1	JMK325ABJ337MM-PE	4	X5R	330 μ	±20	10	150	2.5±0.30	
MSASA32MAB5157MPNDT1	AMK325ABJ157MM-P		X5R	150 μ	±20	10	150	2.5±0.30	
MSASA32MAB5227MPNDT1	AMK325ABJ227MM-P	4	X5R	220 μ	±20	10	150	2.5±0.30	
MSASA32MAB5337MPNDT1	AMK325ABJ337MM-P		X5R	330 μ	±20	10	150	2.5±0.30	

【Temperature Characteristic B5(BJ) : B(-25~+85°C)/X5R(-55~+85°C)】 1.9mm thickness

New part number	Old part number (for reference)	Rated voltage [V]	Temperature characteristics	Capacitance [F]	Capacitance tolerance [%]	tan δ [%]	HTLT	Thickness ^{*3} [mm]	Note
							Rated voltage x %		
MSASU32NSB5475□TNA01	UMK325 BJ475□N-T	50	X5R	4.7 μ	±10, ±20	10	150	1.9±0.20	
MSASG32NSB5225□TNA01	GMK325 BJ225□N-T			B X5R	2.2 μ	±10, ±20	3.5	200	1.9±0.20
MSASG32NSB5475□TNA01	GMK325 BJ475□N-T	35	X5R	4.7 μ	±10, ±20	10	150	1.9±0.20	
MSASG32NSB5106□TNA01	GMK325 BJ106□N-T			X5R	10 μ	±10, ±20	5	150	1.9±0.20
MSAST32NSB5335MTNA01	TMK325 BJ335MN-T	25	X5R ^{*1}	3.3 μ	±20	3.5	200	1.9±0.20	
MSAST32NSB5475□TNA01	TMK325 BJ475□N-T			B X5R ^{*1}	4.7 μ	±10, ±20	3.5	200	1.9±0.20
MSAST32NSB5106□TNA01	TMK325 BJ106□N-T	16	X5R	10 μ	±10, ±20	5	200	1.9±0.20	
MSASE32NSB5475□TNA01	EMK325 BJ475□N-T			B X5R ^{*1}	4.7 μ	±10, ±20	3.5	200	1.9±0.20
MSASE32NSB5106□TNA01	EMK325 BJ106□N-T	10	X5R	10 μ	±10, ±20	3.5	200	1.9±0.20	
MSASE32YBB5476MTNA01	EMK325 BJ476MY-T			X5R	47 μ	±20	10	150	1.9±0.1/-0.2
MSASL32NSB5106□TNA01	LMK325 BJ106□N-T	6.3	X5R	10 μ	±10, ±20	3.5	200	1.9±0.20	
MSASL32YBB5226MTNA01	LMK325 BJ226MY-T			B X5R	22 μ	±20	5	150	1.9±0.1/-0.2
MSASJ32YBB5226MTNA01	JMK325 BJ226MY-T	6.3	X5R	22 μ	±20	5	200	1.9±0.1/-0.2	
MSASJ32NSB5476MTNA01	JMK325 BJ476MN-T			X5R	47 μ	±20	10	150	1.9±0.20
MSASJ32YBB5107MTNA01	JMK325 BJ107MY-T	6.3	X5R	100 μ	±20	10	150	1.9±0.1/-0.2	

【Temperature Characteristic B5(BJ) : B(-25~+85°C)/X5R(-55~+85°C)】 0.85mm thickness

New part number	Old part number (for reference)	Rated voltage [V]	Temperature characteristics	Capacitance [F]	Capacitance tolerance [%]	tan δ [%]	HTLT	Thickness ^{*3} [mm]	Note
							Rated voltage x %		
MSAST329JB5106□TNA01	TMK325 BJ106□D-T	25	X5R	10 μ	±10, ±20	5	150	0.85±0.10	
MSASE329JB5106□TNA01	EMK325 BJ106□D-T	16	X5R	10 μ	±10, ±20	5	150	0.85±0.10	
MSASE329JB5226MTNA01	EMK325 BJ226MD-T			X5R	22 μ	±20	10	150	0.85±0.10
MSASL329JB5335□TNA01	LMK325 BJ335□D-T	10	X5R	3.3 μ	±10, ±20	3.5	200	0.85±0.10	
MSASL329JB5475□TNA01	LMK325 BJ475□D-T			B X5R	4.7 μ	±10, ±20	5	200	0.85±0.10
MSASL329JB5106□TNA01	LMK325 BJ106□D-T	10	X5R	10 μ	±10, ±20	5	150	0.85±0.10	

【Temperature Characteristic C6 : X6S(-55~+105°C)】 2.5mm thickness

New part number	Old part number (for reference)	Rated voltage [V]	Temperature characteristics	Capacitance [F]	Capacitance tolerance [%]	tan δ [%]	HTLT	Thickness ^{*3} [mm]	Note
							Rated voltage x %		
MSASE32MAC6476MPNDT1	EMK325AC6476MM-P	16	X6S	47 μ	±20	10	150	2.5±0.30	
MSASL32MAC6107MPNA01	LMK325AC6107MM-P	10	X6S	100 μ	±20	10	150	2.5±0.30	
MSASA32MAC6157MPNDT1	AMK325AC6157MM-P			X6S	150 μ	±20	10	150	2.5±0.30
MSASA32MAC6227MPNDT1	AMK325AC6227MM-P	4	X6S	220 μ	±20	10	150	2.5±0.30	
MSASA32MAC6337MPNDT1	AMK325AC6337MM-PE			X6S	330 μ	±20	10	150	2.5±0.30
MSASP32MAC6227MPNDT1	PMK325AC6227MM-P	2.5	X6S	220 μ	±20	10	200	2.5±0.30	
MSASP32MAC6337MPNDT1	PMK325AC6337MM-P			X6S	330 μ	±20	10	150	2.5±0.30

* This catalog contains the typical specification only due to the limitation of space. When you consider the purchase of our products, please check our specification.
For details of each product (characteristics graph, reliability information, precautions for use, and so on), see our Web site (<http://www.ty-top.com/>).

PART NUMBER

【Temperature Characteristic C7 : X7S(-55~+125°C)】 2.5mm thickness

New part number	Old part number (for reference)	Rated voltage [V]	Temperature characteristics	Capacitance [F]	Capacitance tolerance [%]	tan δ [%]	HTLT	Thickness*3 [mm]	Note
							Rated voltage x %		
MSASJ32MAC7107MPNA01	JMK325AC7107MM-P	6.3	X7S	100 μ	±20	10	150	2.5±0.30	

【Temperature Characteristic B7 : X7R(-55~+125°C)】 2.5mm thickness

New part number	Old part number (for reference)	Rated voltage [V]	Temperature characteristics	Capacitance [F]	Capacitance tolerance [%]	tan δ [%]	HTLT	Thickness*3 [mm]	Note
							Rated voltage x %		
MSASU32MSB7335□PNA01	UMK325 B7335□M-P	50	X7R	3.3 μ	±10, ±20	3.5	200	2.5±0.20	
MSASU32MSB7475□PNA01	UMK325 B7475□M-P		X7R	4.7 μ	±10, ±20	5	150	2.5±0.20	
MSASU32MAB7106□PNA01	UMK325AB7106□M-P		X7R	10 μ	±10, ±20	10	150	2.5±0.30	
MSAST32MAB7106□PNA01	TMK325AB7106□M-P	25	X7R	10 μ	±10, ±20	10	200	2.5±0.30	
MSAST32MSB7226□PNB25	TMK325 B7226□M-PR		X7R	22 μ	±10, ±20	10	150	2.5±0.20	
MSASE32MSB7226□PNB25	EMK325 B7226□M-PR	16	X7R	22 μ	±10, ±20	10	150	2.5±0.20	
MSASL32MSB7476□PNB25	LMK325 B7476□M-PR	10	X7R	47 μ	±10, ±20	10	150	2.5±0.20	
MSASJ32MSB7476□PNB25	JMK325 B7476□M-PR	6.3	X7R	47 μ	±10, ±20	10	200	2.5±0.20	

【Temperature Characteristic B7 : X7R(-55~+125°C)】 1.9mm thickness

New part number	Old part number (for reference)	Rated voltage [V]	Temperature characteristics	Capacitance [F]	Capacitance tolerance [%]	tan δ [%]	HTLT	Thickness*3 [mm]	Note
							Rated voltage x %		
MSASU32NSB7475□TNB25	UMK325 B7475□N-TR	50	X7R	4.7 μ	±10, ±20	10	150	1.9±0.20	
MSAST32NSB7335□TNA01	TMK325 B7335□N-T	25	X7R	3.3 μ	±10, ±20	3.5	200	1.9±0.20	
MSAST32NSB7475□TNA01	TMK325 B7475□N-T		X7R	4.7 μ	±10, ±20	3.5	150	1.9±0.20	
MSAST32NSB7106□TNB25	TMK325 B7106□N-TR		X7R	10 μ	±10, ±20	10	150	1.9±0.20	
MSASE32NSB7475□TNA01	EMK325 B7475□N-T	16	X7R	4.7 μ	±10, ±20	3.5	200	1.9±0.20	
MSASE32NSB7106□TNA01	EMK325 B7106□N-T		X7R	10 μ	±10, ±20	3.5	150	1.9±0.20	
MSASL32NSB7106□TNA01	LMK325 B7106□N-T	10	X7R	10 μ	±10, ±20	3.5	200	1.9±0.20	

4532TYPE

【Temperature Characteristic B5(BJ) : X5R(-55~+85°C)】 2.5mm thickness

New part number	Old part number (for reference)	Rated voltage [V]	Temperature characteristics	Capacitance [F]	Capacitance tolerance [%]	tan δ [%]	HTLT	Thickness*3 [mm]	Note
							Rated voltage x %		
MSASA45MSB5477MTNA01	AMK432 BJ477MM-T	4	X5R	470 μ	±20	10	150	2.5±0.20	

【Temperature Characteristic C6 : X6S(-55~+105°C)】 2.5mm thickness

New part number	Old part number (for reference)	Rated voltage [V]	Temperature characteristics	Capacitance [F]	Capacitance tolerance [%]	tan δ [%]	HTLT	Thickness*3 [mm]	Note
							Rated voltage x %		
MSASP45MSC6477MTNA01	PMK432 C6477MM-T	2.5	X6S	470 μ	±20	10	150	2.5±0.20	

■ PART NUMBER

Multilayer Ceramic Capacitors (Temperature compensating type) for General Electronic Equipment for Consumer

● 0201TYPE

【Temperature Characteristic $C\Delta : C\Delta/C0\Delta (-55\sim+125^{\circ}C)$ 】 0.125mm thickness

New part number	Old part number (for reference)	Rated voltage [V]	Temperature characteristics		Capacitance [F]	Capacitance tolerance	Q (at 1MHz) (min)	HTLT	Thickness ^{※3} [mm]	Note
								Rated voltage x %		
MSAST021SK0R2B[WNA01	TMK021 CK0R2BK-W	25	CK	C0K	0.2 p	±0.1pF	404	200	0.125±0.013	
MSAST021SK0R3[WNA01	TMK021 CK0R3K-W		CK	C0K	0.3 p	±0.1pF,±0.25pF	406	200	0.125±0.013	
MSAST021SK0R4[WNA01	TMK021 CK0R4K-W		CK	C0K	0.4 p	±0.1pF,±0.25pF	408	200	0.125±0.013	
MSAST021SK0R5[WNA01	TMK021 CK0R5K-W		CK	C0K	0.5 p	±0.1pF,±0.25pF	410	200	0.125±0.013	
MSAST021SK0R6[WNA01	TMK021 CK0R6K-W		CK	C0K	0.6 p	±0.1pF,±0.25pF	412	200	0.125±0.013	
MSAST021SK0R7[WNA01	TMK021 CK0R7K-W		CK	C0K	0.7 p	±0.1pF,±0.25pF	414	200	0.125±0.013	
MSAST021SKR75[WNA01	TMK021 CKR75K-W		CK	C0K	0.75 p	±0.1pF,±0.25pF	415	200	0.125±0.013	
MSAST021SK0R8[WNA01	TMK021 CK0R8K-W		CK	C0K	0.8 p	±0.1pF,±0.25pF	416	200	0.125±0.013	
MSAST021SK0R9[WNA01	TMK021 CK0R9K-W		CK	C0K	0.9 p	±0.1pF,±0.25pF	418	200	0.125±0.013	
MSAST021SK010[WNA01	TMK021 CK010K-W		CK	C0K	1 p	±0.1pF,±0.25pF	420	200	0.125±0.013	
MSAST021SK1R1[WNA01	TMK021 CK1R1K-W		CK	C0K	1.1 p	±0.1pF,±0.25pF	422	200	0.125±0.013	
MSAST021SK1R2[WNA01	TMK021 CK1R2K-W		CK	C0K	1.2 p	±0.1pF,±0.25pF	424	200	0.125±0.013	
MSAST021SK1R3[WNA01	TMK021 CK1R3K-W		CK	C0K	1.3 p	±0.1pF,±0.25pF	426	200	0.125±0.013	
MSAST021SK1R4[WNA01	TMK021 CK1R4K-W		CK	C0K	1.4 p	±0.1pF,±0.25pF	428	200	0.125±0.013	
MSAST021SK1R5[WNA01	TMK021 CK1R5K-W		CK	C0K	1.5 p	±0.1pF,±0.25pF	430	200	0.125±0.013	
MSAST021SK1R6[WNA01	TMK021 CK1R6K-W		CK	C0K	1.6 p	±0.1pF,±0.25pF	432	200	0.125±0.013	
MSAST021SK1R7[WNA01	TMK021 CK1R7K-W		CK	C0K	1.7 p	±0.1pF,±0.25pF	434	200	0.125±0.013	
MSAST021SK1R8[WNA01	TMK021 CK1R8K-W		CK	C0K	1.8 p	±0.1pF,±0.25pF	436	200	0.125±0.013	
MSAST021SK1R9[WNA01	TMK021 CK1R9K-W		CK	C0K	1.9 p	±0.1pF,±0.25pF	438	200	0.125±0.013	
MSAST021SK020[WNA01	TMK021 CK020K-W		CK	C0K	2 p	±0.1pF,±0.25pF	440	200	0.125±0.013	
MSAST021SK2R1[WNA01	TMK021 CK2R1K-W		CK	C0K	2.1 p	±0.1pF,±0.25pF	442	200	0.125±0.013	
MSAST021SK2R2[WNA01	TMK021 CK2R2K-W		CK	C0K	2.2 p	±0.1pF,±0.25pF	444	200	0.125±0.013	
MSAST021SK2R3[WNA01	TMK021 CK2R3K-W		CK	C0K	2.3 p	±0.1pF,±0.25pF	446	200	0.125±0.013	
MSAST021SK2R4[WNA01	TMK021 CK2R4K-W		CK	C0K	2.4 p	±0.1pF,±0.25pF	448	200	0.125±0.013	
MSAST021SK2R5[WNA01	TMK021 CK2R5K-W		CK	C0K	2.5 p	±0.1pF,±0.25pF	450	200	0.125±0.013	
MSAST021SK2R6[WNA01	TMK021 CK2R6K-W	CK	C0K	2.6 p	±0.1pF,±0.25pF	452	200	0.125±0.013		
MSAST021SK2R7[WNA01	TMK021 CK2R7K-W	CK	C0K	2.7 p	±0.1pF,±0.25pF	454	200	0.125±0.013		
MSAST021SK2R8[WNA01	TMK021 CK2R8K-W	CK	C0K	2.8 p	±0.1pF,±0.25pF	456	200	0.125±0.013		
MSAST021SK2R9[WNA01	TMK021 CK2R9K-W	CK	C0K	2.9 p	±0.1pF,±0.25pF	458	200	0.125±0.013		
MSAST021SCJ030[WNA01	TMK021 CJ030K-W	CH	C0H	3 p	±0.1pF,±0.25pF	460	200	0.125±0.013		
MSAST021SCJ3R1[WNA01	TMK021 CJ3R1K-W	CH	C0H	3.1 p	±0.1pF,±0.25pF	462	200	0.125±0.013		
MSAST021SCJ3R2[WNA01	TMK021 CJ3R2K-W	CH	C0H	3.2 p	±0.1pF,±0.25pF	464	200	0.125±0.013		
MSAST021SCJ3R3[WNA01	TMK021 CJ3R3K-W	CH	C0H	3.3 p	±0.1pF,±0.25pF	466	200	0.125±0.013		
MSAST021SCJ3R4[WNA01	TMK021 CJ3R4K-W	CH	C0H	3.4 p	±0.1pF,±0.25pF	468	200	0.125±0.013		
MSAST021SCJ3R5[WNA01	TMK021 CJ3R5K-W	CH	C0H	3.5 p	±0.1pF,±0.25pF	470	200	0.125±0.013		
MSAST021SCJ3R6[WNA01	TMK021 CJ3R6K-W	CH	C0H	3.6 p	±0.1pF,±0.25pF	472	200	0.125±0.013		
MSAST021SCJ3R7[WNA01	TMK021 CJ3R7K-W	CH	C0H	3.7 p	±0.1pF,±0.25pF	474	200	0.125±0.013		
MSAST021SCJ3R8[WNA01	TMK021 CJ3R8K-W	CH	C0H	3.8 p	±0.1pF,±0.25pF	476	200	0.125±0.013		
MSAST021SCJ3R9[WNA01	TMK021 CJ3R9K-W	CH	C0H	3.9 p	±0.1pF,±0.25pF	478	200	0.125±0.013		
MSAST021SCH040[WNA01	TMK021 CH040K-W	CH	C0H	4 p	±0.1pF,±0.25pF	480	200	0.125±0.013		
MSAST021SCH4R1[WNA01	TMK021 CH4R1K-W	CH	C0H	4.1 p	±0.1pF,±0.25pF	482	200	0.125±0.013		
MSAST021SCH4R2[WNA01	TMK021 CH4R2K-W	CH	C0H	4.2 p	±0.1pF,±0.25pF	484	200	0.125±0.013		
MSAST021SCH4R3[WNA01	TMK021 CH4R3K-W	CH	C0H	4.3 p	±0.1pF,±0.25pF	486	200	0.125±0.013		
MSAST021SCH4R4[WNA01	TMK021 CH4R4K-W	CH	C0H	4.4 p	±0.1pF,±0.25pF	488	200	0.125±0.013		
MSAST021SCH4R5[WNA01	TMK021 CH4R5K-W	CH	C0H	4.5 p	±0.1pF,±0.25pF	490	200	0.125±0.013		
MSAST021SCH4R6[WNA01	TMK021 CH4R6K-W	CH	C0H	4.6 p	±0.1pF,±0.25pF	492	200	0.125±0.013		
MSAST021SCH4R7[WNA01	TMK021 CH4R7K-W	CH	C0H	4.7 p	±0.1pF,±0.25pF	494	200	0.125±0.013		
MSAST021SCH4R8[WNA01	TMK021 CH4R8K-W	CH	C0H	4.8 p	±0.1pF,±0.25pF	496	200	0.125±0.013		
MSAST021SCH4R9[WNA01	TMK021 CH4R9K-W	CH	C0H	4.9 p	±0.1pF,±0.25pF	498	200	0.125±0.013		
MSAST021SCH050[WNA01	TMK021 CH050K-W	CH	C0H	5 p	±0.1pF,±0.25pF	500	200	0.125±0.013		
MSAST021SCH5R1[WNA01	TMK021 CH5R1K-W	CH	C0H	5.1 p	±0.25pF,±0.5pF	502	200	0.125±0.013		
MSAST021SCH5R2[WNA01	TMK021 CH5R2K-W	CH	C0H	5.2 p	±0.25pF,±0.5pF	504	200	0.125±0.013		
MSAST021SCH5R3[WNA01	TMK021 CH5R3K-W	CH	C0H	5.3 p	±0.25pF,±0.5pF	506	200	0.125±0.013		
MSAST021SCH5R4[WNA01	TMK021 CH5R4K-W	CH	C0H	5.4 p	±0.25pF,±0.5pF	508	200	0.125±0.013		
MSAST021SCH5R5[WNA01	TMK021 CH5R5K-W	CH	C0H	5.5 p	±0.25pF,±0.5pF	510	200	0.125±0.013		
MSAST021SCH5R6[WNA01	TMK021 CH5R6K-W	CH	C0H	5.6 p	±0.25pF,±0.5pF	512	200	0.125±0.013		
MSAST021SCH5R7[WNA01	TMK021 CH5R7K-W	CH	C0H	5.7 p	±0.25pF,±0.5pF	514	200	0.125±0.013		
MSAST021SCH5R8[WNA01	TMK021 CH5R8K-W	CH	C0H	5.8 p	±0.25pF,±0.5pF	516	200	0.125±0.013		
MSAST021SCH5R9[WNA01	TMK021 CH5R9K-W	CH	C0H	5.9 p	±0.25pF,±0.5pF	518	200	0.125±0.013		
MSAST021SCH060[WNA01	TMK021 CH060K-W	CH	C0H	6 p	±0.25pF,±0.5pF	520	200	0.125±0.013		
MSAST021SCH6R1[WNA01	TMK021 CH6R1K-W	CH	C0H	6.1 p	±0.25pF,±0.5pF	522	200	0.125±0.013		
MSAST021SCH6R2[WNA01	TMK021 CH6R2K-W	CH	C0H	6.2 p	±0.25pF,±0.5pF	524	200	0.125±0.013		
MSAST021SCH6R3[WNA01	TMK021 CH6R3K-W	CH	C0H	6.3 p	±0.25pF,±0.5pF	526	200	0.125±0.013		
MSAST021SCH6R4[WNA01	TMK021 CH6R4K-W	CH	C0H	6.4 p	±0.25pF,±0.5pF	528	200	0.125±0.013		
MSAST021SCH6R5[WNA01	TMK021 CH6R5K-W	CH	C0H	6.5 p	±0.25pF,±0.5pF	530	200	0.125±0.013		
MSAST021SCH6R6[WNA01	TMK021 CH6R6K-W	CH	C0H	6.6 p	±0.25pF,±0.5pF	532	200	0.125±0.013		
MSAST021SCH6R7[WNA01	TMK021 CH6R7K-W	CH	C0H	6.7 p	±0.25pF,±0.5pF	534	200	0.125±0.013		
MSAST021SCH6R8[WNA01	TMK021 CH6R8K-W	CH	C0H	6.8 p	±0.25pF,±0.5pF	536	200	0.125±0.013		
MSAST021SCH6R9[WNA01	TMK021 CH6R9K-W	CH	C0H	6.9 p	±0.25pF,±0.5pF	538	200	0.125±0.013		
MSAST021SCH070[WNA01	TMK021 CH070K-W	CH	C0H	7 p	±0.25pF,±0.5pF	540	200	0.125±0.013		
MSAST021SCH7R1[WNA01	TMK021 CH7R1K-W	CH	C0H	7.1 p	±0.25pF,±0.5pF	542	200	0.125±0.013		
MSAST021SCH7R2[WNA01	TMK021 CH7R2K-W	CH	C0H	7.2 p	±0.25pF,±0.5pF	544	200	0.125±0.013		
MSAST021SCH7R3[WNA01	TMK021 CH7R3K-W	CH	C0H	7.3 p	±0.25pF,±0.5pF	546	200	0.125±0.013		
MSAST021SCH7R4[WNA01	TMK021 CH7R4K-W	CH	C0H	7.4 p	±0.25pF,±0.5pF	548	200	0.125±0.013		
MSAST021SCH7R5[WNA01	TMK021 CH7R5K-W	CH	C0H	7.5 p	±0.25pF,±0.5pF	550	200	0.125±0.013		
MSAST021SCH7R6[WNA01	TMK021 CH7R6K-W	CH	C0H	7.6 p	±0.25pF,±0.5pF	552	200	0.125±0.013		
MSAST021SCH7R7[WNA01	TMK021 CH7R7K-W	CH	C0H	7.7 p	±0.25pF,±0.5pF	554	200	0.125±0.013		
MSAST021SCH7R8[WNA01	TMK021 CH7R8K-W	CH	C0H	7.8 p	±0.25pF,±0.5pF	556	200	0.125±0.013		
MSAST021SCH7R9[WNA01	TMK021 CH7R9K-W	CH	C0H	7.9 p	±0.25pF,±0.5pF	558	200	0.125±0.013		
MSAST021SCH080[WNA01	TMK021 CH080K-W	CH	C0H	8 p	±0.25pF,±0.5pF	560	200	0.125±0.013		
MSAST021SCH8R1[WNA01	TMK021 CH8R1K-W	CH	C0H	8.1 p	±0.25pF,±0.5pF	562	200	0.125±0.013		
MSAST021SCH8R2[WNA01	TMK021 CH8R2K-W	CH	C0H	8.2 p	±0.25pF,±0.5pF	564	200	0.125±0.013		

▶ This catalog contains the typical specification only due to the limitation of space. When you consider the purchase of our products, please check our specification.
For details of each product (characteristics graph, reliability information, precautions for use, and so on), see our Web site (<http://www.ty-top.com/>).

PART NUMBER

New part number	Old part number (for reference)	Rated voltage [V]	Temperature characteristics		Capacitance [F]	Capacitance tolerance	Q (at 1MHz) (min)	HTLT	Thickness ^{*3} [mm]	Note	
								Rated voltage x %			
MSAST021SCH8R3□WNA01	TMK021 CH8R3□K-W	25	CH	C0H	8.3 p	±0.25pF,±0.5pF	566	200	0.125±0.013		
MSAST021SCH8R4□WNA01	TMK021 CH8R4□K-W		CH	C0H	8.4 p	±0.25pF,±0.5pF	568	200	0.125±0.013		
MSAST021SCH8R5□WNA01	TMK021 CH8R5□K-W		CH	C0H	8.5 p	±0.25pF,±0.5pF	570	200	0.125±0.013		
MSAST021SCH8R6□WNA01	TMK021 CH8R6□K-W		CH	C0H	8.6 p	±0.25pF,±0.5pF	572	200	0.125±0.013		
MSAST021SCH8R7□WNA01	TMK021 CH8R7□K-W		CH	C0H	8.7 p	±0.25pF,±0.5pF	574	200	0.125±0.013		
MSAST021SCH8R8□WNA01	TMK021 CH8R8□K-W		CH	C0H	8.8 p	±0.25pF,±0.5pF	576	200	0.125±0.013		
MSAST021SCH8R9□WNA01	TMK021 CH8R9□K-W		CH	C0H	8.9 p	±0.25pF,±0.5pF	578	200	0.125±0.013		
MSAST021SCH090□WNA01	TMK021 CH090□K-W		CH	C0H	9 p	±0.25pF,±0.5pF	580	200	0.125±0.013		
MSAST021SCH9R1□WNA01	TMK021 CH9R1□K-W		CH	C0H	9.1 p	±0.25pF,±0.5pF	582	200	0.125±0.013		
MSAST021SCH9R2□WNA01	TMK021 CH9R2□K-W		CH	C0H	9.2 p	±0.25pF,±0.5pF	584	200	0.125±0.013		
MSAST021SCH9R3□WNA01	TMK021 CH9R3□K-W		CH	C0H	9.3 p	±0.25pF,±0.5pF	586	200	0.125±0.013		
MSAST021SCH9R4□WNA01	TMK021 CH9R4□K-W		CH	C0H	9.4 p	±0.25pF,±0.5pF	588	200	0.125±0.013		
MSAST021SCH9R5□WNA01	TMK021 CH9R5□K-W		CH	C0H	9.5 p	±0.25pF,±0.5pF	590	200	0.125±0.013		
MSAST021SCH9R6□WNA01	TMK021 CH9R6□K-W		CH	C0H	9.6 p	±0.25pF,±0.5pF	592	200	0.125±0.013		
MSAST021SCH9R7□WNA01	TMK021 CH9R7□K-W		CH	C0H	9.7 p	±0.25pF,±0.5pF	594	200	0.125±0.013		
MSAST021SCH9R8□WNA01	TMK021 CH9R8□K-W		CH	C0H	9.8 p	±0.25pF,±0.5pF	596	200	0.125±0.013		
MSAST021SCH9R9□WNA01	TMK021 CH9R9□K-W		CH	C0H	9.9 p	±0.25pF,±0.5pF	598	200	0.125±0.013		
MSAST021SCH100□WNA01	TMK021 CH100□K-W		CH	C0H	10 p	±0.25pF,±0.5pF	600	200	0.125±0.013		
MSAST021SCH120JWNA01	TMK021 CH120JK-W		CH	C0H	12 p	±5%	640	200	0.125±0.013		
MSAST021SCH150JWNA01	TMK021 CH150JK-W		CH	C0H	15 p	±5%	700	200	0.125±0.013		
MSAST021SCH180JWNA01	TMK021 CH180JK-W		CH	C0H	18 p	±5%	760	200	0.125±0.013		
MSAST021SCH220JWNA01	TMK021 CH220JK-W		CH	C0H	22 p	±5%	840	200	0.125±0.013		
MSAST021SCH270JWNA01	TMK021 CH270JK-W		CH	C0H	27 p	±5%	940	200	0.125±0.013		
MSASE021SCH330JWNA01	EMK021 CH330JK-W		16	CH	C0H	33 p	±5%	1000	150	0.125±0.013	
MSASE021SCH390JWNA01	EMK021 CH390JK-W			CH	C0H	39 p	±5%	1000	150	0.125±0.013	
MSASE021SCH470JWNA01	EMK021 CH470JK-W			CH	C0H	47 p	±5%	1000	150	0.125±0.013	
MSASE021SCH560JWNA01	EMK021 CH560JK-W		CH	C0H	56 p	±5%	1000	150	0.125±0.013		
MSASL021SCH680JWNA01	LMK021 CH680JK-W		10	CH	C0H	68 p	±5%	1000	200	0.125±0.013	
MSASL021SCH820JWNA01	LMK021 CH820JK-W			CH	C0H	82 p	±5%	1000	200	0.125±0.013	
MSASL021SCH101JWNA01	LMK021 CH101JK-W			CH	C0H	100 p	±5%	1000	200	0.125±0.013	

► This catalog contains the typical specification only due to the limitation of space. When you consider the purchase of our products, please check our specification.
For details of each product (characteristics graph, reliability information, precautions for use, and so on), see our Web site (<http://www.ty-top.com/>).

■ PART NUMBER

New part number	Old part number (for reference)	Rated voltage [V]	Temperature characteristics	Capacitance [F]	Capacitance tolerance	Q (at 1MHz) (min)	HTLT	Thickness ⁹³ [mm]	Note
							Rated voltage x %		
MSAST021SCG0R2BWNA01	TMK021 CG0R2BK-W	25	CG C0G	0.2 p	±0.1pF	404	200	0.125±0.013	
MSAST021SCG0R3WNA01	TMK021 CG0R3K-W		CG C0G	0.3 p	±0.1pF,±0.25pF	406	200	0.125±0.013	
MSAST021SCG0R4WNA01	TMK021 CG0R4K-W		CG C0G	0.4 p	±0.1pF,±0.25pF	408	200	0.125±0.013	
MSAST021SCG0R5WNA01	TMK021 CG0R5K-W		CG C0G	0.5 p	±0.1pF,±0.25pF	410	200	0.125±0.013	
MSAST021SCG0R6WNA01	TMK021 CG0R6K-W		CG C0G	0.6 p	±0.1pF,±0.25pF	412	200	0.125±0.013	
MSAST021SCG0R7WNA01	TMK021 CG0R7K-W		CG C0G	0.7 p	±0.1pF,±0.25pF	414	200	0.125±0.013	
MSAST021SCG0R75WNA01	TMK021 CGR75K-W		CG C0G	0.75 p	±0.1pF,±0.25pF	415	200	0.125±0.013	
MSAST021SCG0R8WNA01	TMK021 CG0R8K-W		CG C0G	0.8 p	±0.1pF,±0.25pF	416	200	0.125±0.013	
MSAST021SCG0R9WNA01	TMK021 CG0R9K-W		CG C0G	0.9 p	±0.1pF,±0.25pF	418	200	0.125±0.013	
MSAST021SCG010WNA01	TMK021 CG010K-W		CG C0G	1 p	±0.1pF,±0.25pF	420	200	0.125±0.013	
MSAST021SCG1R1WNA01	TMK021 CG1R1K-W		CG C0G	1.1 p	±0.1pF,±0.25pF	422	200	0.125±0.013	
MSAST021SCG1R2WNA01	TMK021 CG1R2K-W		CG C0G	1.2 p	±0.1pF,±0.25pF	424	200	0.125±0.013	
MSAST021SCG1R3WNA01	TMK021 CG1R3K-W		CG C0G	1.3 p	±0.1pF,±0.25pF	426	200	0.125±0.013	
MSAST021SCG1R4WNA01	TMK021 CG1R4K-W		CG C0G	1.4 p	±0.1pF,±0.25pF	428	200	0.125±0.013	
MSAST021SCG1R5WNA01	TMK021 CG1R5K-W		CG C0G	1.5 p	±0.1pF,±0.25pF	430	200	0.125±0.013	
MSAST021SCG1R6WNA01	TMK021 CG1R6K-W		CG C0G	1.6 p	±0.1pF,±0.25pF	432	200	0.125±0.013	
MSAST021SCG1R7WNA01	TMK021 CG1R7K-W		CG C0G	1.7 p	±0.1pF,±0.25pF	434	200	0.125±0.013	
MSAST021SCG1R8WNA01	TMK021 CG1R8K-W		CG C0G	1.8 p	±0.1pF,±0.25pF	436	200	0.125±0.013	
MSAST021SCG1R9WNA01	TMK021 CG1R9K-W		CG C0G	1.9 p	±0.1pF,±0.25pF	438	200	0.125±0.013	
MSAST021SCG020WNA01	TMK021 CG020K-W		CG C0G	2 p	±0.1pF,±0.25pF	440	200	0.125±0.013	
MSAST021SCG2R1WNA01	TMK021 CG2R1K-W		CG C0G	2.1 p	±0.1pF,±0.25pF	442	200	0.125±0.013	
MSAST021SCG2R2WNA01	TMK021 CG2R2K-W		CG C0G	2.2 p	±0.1pF,±0.25pF	444	200	0.125±0.013	
MSAST021SCG2R3WNA01	TMK021 CG2R3K-W		CG C0G	2.3 p	±0.1pF,±0.25pF	446	200	0.125±0.013	
MSAST021SCG2R4WNA01	TMK021 CG2R4K-W		CG C0G	2.4 p	±0.1pF,±0.25pF	448	200	0.125±0.013	
MSAST021SCG2R5WNA01	TMK021 CG2R5K-W		CG C0G	2.5 p	±0.1pF,±0.25pF	450	200	0.125±0.013	
MSAST021SCG2R6WNA01	TMK021 CG2R6K-W		CG C0G	2.6 p	±0.1pF,±0.25pF	452	200	0.125±0.013	
MSAST021SCG2R7WNA01	TMK021 CG2R7K-W		CG C0G	2.7 p	±0.1pF,±0.25pF	454	200	0.125±0.013	
MSAST021SCG2R8WNA01	TMK021 CG2R8K-W		CG C0G	2.8 p	±0.1pF,±0.25pF	456	200	0.125±0.013	
MSAST021SCG2R9WNA01	TMK021 CG2R9K-W		CG C0G	2.9 p	±0.1pF,±0.25pF	458	200	0.125±0.013	
MSAST021SCG030WNA01	TMK021 CG030K-W		CG C0G	3 p	±0.1pF,±0.25pF	460	200	0.125±0.013	
MSAST021SCG3R1WNA01	TMK021 CG3R1K-W		CG C0G	3.1 p	±0.1pF,±0.25pF	462	200	0.125±0.013	
MSAST021SCG3R2WNA01	TMK021 CG3R2K-W		CG C0G	3.2 p	±0.1pF,±0.25pF	464	200	0.125±0.013	
MSAST021SCG3R3WNA01	TMK021 CG3R3K-W		CG C0G	3.3 p	±0.1pF,±0.25pF	466	200	0.125±0.013	
MSAST021SCG3R4WNA01	TMK021 CG3R4K-W		CG C0G	3.4 p	±0.1pF,±0.25pF	468	200	0.125±0.013	
MSAST021SCG3R5WNA01	TMK021 CG3R5K-W		CG C0G	3.5 p	±0.1pF,±0.25pF	470	200	0.125±0.013	
MSAST021SCG3R6WNA01	TMK021 CG3R6K-W		CG C0G	3.6 p	±0.1pF,±0.25pF	472	200	0.125±0.013	
MSAST021SCG3R7WNA01	TMK021 CG3R7K-W		CG C0G	3.7 p	±0.1pF,±0.25pF	474	200	0.125±0.013	
MSAST021SCG3R8WNA01	TMK021 CG3R8K-W		CG C0G	3.8 p	±0.1pF,±0.25pF	476	200	0.125±0.013	
MSAST021SCG3R9WNA01	TMK021 CG3R9K-W		CG C0G	3.9 p	±0.1pF,±0.25pF	478	200	0.125±0.013	
MSAST021SCG040WNA01	TMK021 CG040K-W		CG C0G	4 p	±0.1pF,±0.25pF	480	200	0.125±0.013	
MSAST021SCG4R1WNA01	TMK021 CG4R1K-W		CG C0G	4.1 p	±0.1pF,±0.25pF	482	200	0.125±0.013	
MSAST021SCG4R2WNA01	TMK021 CG4R2K-W		CG C0G	4.2 p	±0.1pF,±0.25pF	484	200	0.125±0.013	
MSAST021SCG4R3WNA01	TMK021 CG4R3K-W		CG C0G	4.3 p	±0.1pF,±0.25pF	486	200	0.125±0.013	
MSAST021SCG4R4WNA01	TMK021 CG4R4K-W		CG C0G	4.4 p	±0.1pF,±0.25pF	488	200	0.125±0.013	
MSAST021SCG4R5WNA01	TMK021 CG4R5K-W		CG C0G	4.5 p	±0.1pF,±0.25pF	490	200	0.125±0.013	
MSAST021SCG4R6WNA01	TMK021 CG4R6K-W		CG C0G	4.6 p	±0.1pF,±0.25pF	492	200	0.125±0.013	
MSAST021SCG4R7WNA01	TMK021 CG4R7K-W		CG C0G	4.7 p	±0.1pF,±0.25pF	494	200	0.125±0.013	
MSAST021SCG4R8WNA01	TMK021 CG4R8K-W		CG C0G	4.8 p	±0.1pF,±0.25pF	496	200	0.125±0.013	
MSAST021SCG4R9WNA01	TMK021 CG4R9K-W		CG C0G	4.9 p	±0.1pF,±0.25pF	498	200	0.125±0.013	
MSAST021SCG050WNA01	TMK021 CG050K-W		CG C0G	5 p	±0.1pF,±0.25pF	500	200	0.125±0.013	
MSAST021SCG5R1WNA01	TMK021 CG5R1K-W	CG C0G	5.1 p	±0.25pF,±0.5pF	502	200	0.125±0.013		
MSAST021SCG5R2WNA01	TMK021 CG5R2K-W	CG C0G	5.2 p	±0.25pF,±0.5pF	504	200	0.125±0.013		
MSAST021SCG5R3WNA01	TMK021 CG5R3K-W	CG C0G	5.3 p	±0.25pF,±0.5pF	506	200	0.125±0.013		
MSAST021SCG5R4WNA01	TMK021 CG5R4K-W	CG C0G	5.4 p	±0.25pF,±0.5pF	508	200	0.125±0.013		
MSAST021SCG5R5WNA01	TMK021 CG5R5K-W	CG C0G	5.5 p	±0.25pF,±0.5pF	510	200	0.125±0.013		
MSAST021SCG5R6WNA01	TMK021 CG5R6K-W	CG C0G	5.6 p	±0.25pF,±0.5pF	512	200	0.125±0.013		
MSAST021SCG5R7WNA01	TMK021 CG5R7K-W	CG C0G	5.7 p	±0.25pF,±0.5pF	514	200	0.125±0.013		
MSAST021SCG5R8WNA01	TMK021 CG5R8K-W	CG C0G	5.8 p	±0.25pF,±0.5pF	516	200	0.125±0.013		
MSAST021SCG5R9WNA01	TMK021 CG5R9K-W	CG C0G	5.9 p	±0.25pF,±0.5pF	518	200	0.125±0.013		
MSAST021SCG060WNA01	TMK021 CG060K-W	CG C0G	6 p	±0.25pF,±0.5pF	520	200	0.125±0.013		
MSAST021SCG6R1WNA01	TMK021 CG6R1K-W	CG C0G	6.1 p	±0.25pF,±0.5pF	522	200	0.125±0.013		
MSAST021SCG6R2WNA01	TMK021 CG6R2K-W	CG C0G	6.2 p	±0.25pF,±0.5pF	524	200	0.125±0.013		
MSAST021SCG6R3WNA01	TMK021 CG6R3K-W	CG C0G	6.3 p	±0.25pF,±0.5pF	526	200	0.125±0.013		
MSAST021SCG6R4WNA01	TMK021 CG6R4K-W	CG C0G	6.4 p	±0.25pF,±0.5pF	528	200	0.125±0.013		
MSAST021SCG6R5WNA01	TMK021 CG6R5K-W	CG C0G	6.5 p	±0.25pF,±0.5pF	530	200	0.125±0.013		
MSAST021SCG6R6WNA01	TMK021 CG6R6K-W	CG C0G	6.6 p	±0.25pF,±0.5pF	532	200	0.125±0.013		
MSAST021SCG6R7WNA01	TMK021 CG6R7K-W	CG C0G	6.7 p	±0.25pF,±0.5pF	534	200	0.125±0.013		
MSAST021SCG6R8WNA01	TMK021 CG6R8K-W	CG C0G	6.8 p	±0.25pF,±0.5pF	536	200	0.125±0.013		
MSAST021SCG6R9WNA01	TMK021 CG6R9K-W	CG C0G	6.9 p	±0.25pF,±0.5pF	538	200	0.125±0.013		
MSAST021SCG070WNA01	TMK021 CG070K-W	CG C0G	7 p	±0.25pF,±0.5pF	540	200	0.125±0.013		
MSAST021SCG7R1WNA01	TMK021 CG7R1K-W	CG C0G	7.1 p	±0.25pF,±0.5pF	542	200	0.125±0.013		
MSAST021SCG7R2WNA01	TMK021 CG7R2K-W	CG C0G	7.2 p	±0.25pF,±0.5pF	544	200	0.125±0.013		
MSAST021SCG7R3WNA01	TMK021 CG7R3K-W	CG C0G	7.3 p	±0.25pF,±0.5pF	546	200	0.125±0.013		
MSAST021SCG7R4WNA01	TMK021 CG7R4K-W	CG C0G	7.4 p	±0.25pF,±0.5pF	548	200	0.125±0.013		
MSAST021SCG7R5WNA01	TMK021 CG7R5K-W	CG C0G	7.5 p	±0.25pF,±0.5pF	550	200	0.125±0.013		
MSAST021SCG7R6WNA01	TMK021 CG7R6K-W	CG C0G	7.6 p	±0.25pF,±0.5pF	552	200	0.125±0.013		
MSAST021SCG7R7WNA01	TMK021 CG7R7K-W	CG C0G	7.7 p	±0.25pF,±0.5pF	554	200	0.125±0.013		
MSAST021SCG7R8WNA01	TMK021 CG7R8K-W	CG C0G	7.8 p	±0.25pF,±0.5pF	556	200	0.125±0.013		
MSAST021SCG7R9WNA01	TMK021 CG7R9K-W	CG C0G	7.9 p	±0.25pF,±0.5pF	558	200	0.125±0.013		
MSAST021SCG080WNA01	TMK021 CG080K-W	CG C0G	8 p	±0.25pF,±0.5pF	560	200	0.125±0.013		
MSAST021SCG8R1WNA01	TMK021 CG8R1K-W	CG C0G	8.1 p	±0.25pF,±0.5pF	562	200	0.125±0.013		
MSAST021SCG8R2WNA01	TMK021 CG8R2K-W	CG C0G	8.2 p	±0.25pF,±0.5pF	564	200	0.125±0.013		
MSAST021SCG8R3WNA01	TMK021 CG8R3K-W	CG C0G	8.3 p	±0.25pF,±0.5pF	566	200	0.125±0.013		
MSAST021SCG8R4WNA01	TMK021 CG8R4K-W	CG C0G	8.4 p	±0.25pF,±0.5pF	568	200	0.125±0.013		
MSAST021SCG8R5WNA01	TMK021 CG8R5K-W	CG C0G	8.5 p	±0.25pF,±0.5pF	570	200	0.125±0.013		
MSAST021SCG8R6WNA01	TMK021 CG8R6K-W	CG C0G	8.6 p	±0.25pF,±0.5pF	572	200	0.125±0.013		
MSAST021SCG8R7WNA01	TMK021 CG8R7K-W	CG C0G	8.7 p	±0.25pF,±0.5pF	574	200	0.125±0.013		

▶ This catalog contains the typical specification only due to the limitation of space. When you consider the purchase of our products, please check our specification.
 For details of each product (characteristics graph, reliability information, precautions for use, and so on), see our Web site (<http://www.ty-top.com/>).

■ PART NUMBER

New part number	Old part number (for reference)	Rated voltage [V]	Temperature characteristics		Capacitance [F]	Capacitance tolerance	Q (at 1MHz) (min)	HTLT	Thickness ^{*3} [mm]	Note	
								Rated voltage x %			
MSAST021SCG8R8□WNA01	TMK021 CG8R8□K-W	25	CG	C0G	8.8 p	±0.25pF,±0.5pF	576	200	0.125±0.013		
MSAST021SCG8R9□WNA01	TMK021 CG8R9□K-W		CG	C0G	8.9 p	±0.25pF,±0.5pF	578	200	0.125±0.013		
MSAST021SCG090□WNA01	TMK021 CG090□K-W		CG	C0G	9 p	±0.25pF,±0.5pF	580	200	0.125±0.013		
MSAST021SCG9R1□WNA01	TMK021 CG9R1□K-W		CG	C0G	9.1 p	±0.25pF,±0.5pF	582	200	0.125±0.013		
MSAST021SCG9R2□WNA01	TMK021 CG9R2□K-W		CG	C0G	9.2 p	±0.25pF,±0.5pF	584	200	0.125±0.013		
MSAST021SCG9R3□WNA01	TMK021 CG9R3□K-W		CG	C0G	9.3 p	±0.25pF,±0.5pF	586	200	0.125±0.013		
MSAST021SCG9R4□WNA01	TMK021 CG9R4□K-W		CG	C0G	9.4 p	±0.25pF,±0.5pF	588	200	0.125±0.013		
MSAST021SCG9R5□WNA01	TMK021 CG9R5□K-W		CG	C0G	9.5 p	±0.25pF,±0.5pF	590	200	0.125±0.013		
MSAST021SCG9R6□WNA01	TMK021 CG9R6□K-W		CG	C0G	9.6 p	±0.25pF,±0.5pF	592	200	0.125±0.013		
MSAST021SCG9R7□WNA01	TMK021 CG9R7□K-W		CG	C0G	9.7 p	±0.25pF,±0.5pF	594	200	0.125±0.013		
MSAST021SCG9R8□WNA01	TMK021 CG9R8□K-W		CG	C0G	9.8 p	±0.25pF,±0.5pF	596	200	0.125±0.013		
MSAST021SCG9R9□WNA01	TMK021 CG9R9□K-W		CG	C0G	9.9 p	±0.25pF,±0.5pF	598	200	0.125±0.013		
MSAST021SCG100□WNA01	TMK021 CG100□K-W		CG	C0G	10 p	±0.25pF,±0.5pF	600	200	0.125±0.013		
MSAST021SCG120JWNA01	TMK021 CG120JK-W		CG	C0G	12 p	±5%	640	200	0.125±0.013		
MSAST021SCG150JWNA01	TMK021 CG150JK-W		CG	C0G	15 p	±5%	700	200	0.125±0.013		
MSAST021SCG180JWNA01	TMK021 CG180JK-W		CG	C0G	18 p	±5%	760	200	0.125±0.013		
MSAST021SCG220JWNA01	TMK021 CG220JK-W		CG	C0G	22 p	±5%	840	200	0.125±0.013		
MSAST021SCG270JWNA01	TMK021 CG270JK-W		CG	C0G	27 p	±5%	940	200	0.125±0.013		
MSASE021SCG330JWNA01	EMK021 CG330JK-W		16	CG	C0G	33 p	±5%	1000	150	0.125±0.013	
MSASE021SCG390JWNA01	EMK021 CG390JK-W			CG	C0G	39 p	±5%	1000	150	0.125±0.013	
MSASE021SCG470JWNA01	EMK021 CG470JK-W			CG	C0G	47 p	±5%	1000	150	0.125±0.013	
MSASE021SCG560JWNA01	EMK021 CG560JK-W			CG	C0G	56 p	±5%	1000	150	0.125±0.013	
MSASL021SCG680JWNA01	LMK021 CG680JK-W		10	CG	C0G	68 p	±5%	1000	200	0.125±0.013	
MSASL021SCG820JWNA01	LMK021 CG820JK-W			CG	C0G	82 p	±5%	1000	200	0.125±0.013	
MSASL021SCG101JWNA01	LMK021 CG101JK-W			CG	C0G	100 p	±5%	1000	200	0.125±0.013	

► This catalog contains the typical specification only due to the limitation of space. When you consider the purchase of our products, please check our specification.
For details of each product (characteristics graph, reliability information, precautions for use, and so on), see our Web site (<http://www.ty-top.com/>).

■ PART NUMBER

● 0402TYPE

【Temperature Characteristic $C\Delta : C\Delta/C0\Delta (-55\sim+125^{\circ}C)$ 】 0.2mm thickness

New part number	Old part number (for reference)	Rated voltage [V]	Temperature characteristics		Capacitance [F]	Capacitance tolerance	Q (at 1MHz) (min)	HTLT	Thickness ³ [mm]	Note
								Rated voltage x %		
MSAST042SCK0R4[WNA01]	TMK042 CK0R4[D-W]	25	CK	C0K	0.4 p	$\pm 0.05pF, \pm 0.1pF, \pm 0.25pF$	408	200	0.2±0.02	
MSAST042SCK0R5[WNA01]	TMK042 CK0R5[D-W]		CK	C0K	0.5 p	$\pm 0.05pF, \pm 0.1pF, \pm 0.25pF$	410	200	0.2±0.02	
MSAST042SCK0R6[WNA01]	TMK042 CK0R6[D-W]		CK	C0K	0.6 p	$\pm 0.05pF, \pm 0.1pF, \pm 0.25pF$	412	200	0.2±0.02	
MSAST042SCK0R7[WNA01]	TMK042 CK0R7[D-W]		CK	C0K	0.7 p	$\pm 0.05pF, \pm 0.1pF, \pm 0.25pF$	414	200	0.2±0.02	
MSAST042SCKR75[WNA01]	TMK042 CKR75[D-W]		CK	C0K	0.75 p	$\pm 0.05pF, \pm 0.1pF, \pm 0.25pF$	415	200	0.2±0.02	
MSAST042SCK0R8[WNA01]	TMK042 CK0R8[D-W]		CK	C0K	0.8 p	$\pm 0.05pF, \pm 0.1pF, \pm 0.25pF$	416	200	0.2±0.02	
MSAST042SCK0R9[WNA01]	TMK042 CK0R9[D-W]		CK	C0K	0.9 p	$\pm 0.05pF, \pm 0.1pF, \pm 0.25pF$	418	200	0.2±0.02	
MSAST042SCK010[WNA01]	TMK042 CK010[D-W]		CK	C0K	1 p	$\pm 0.05pF, \pm 0.1pF, \pm 0.25pF$	420	200	0.2±0.02	
MSAST042SCK1R1[WNA01]	TMK042 CK1R1[D-W]		CK	C0K	1.1 p	$\pm 0.05pF, \pm 0.1pF, \pm 0.25pF$	422	200	0.2±0.02	
MSAST042SCK1R2[WNA01]	TMK042 CK1R2[D-W]		CK	C0K	1.2 p	$\pm 0.05pF, \pm 0.1pF, \pm 0.25pF$	424	200	0.2±0.02	
MSAST042SCK1R3[WNA01]	TMK042 CK1R3[D-W]		CK	C0K	1.3 p	$\pm 0.05pF, \pm 0.1pF, \pm 0.25pF$	426	200	0.2±0.02	
MSAST042SCK1R4[WNA01]	TMK042 CK1R4[D-W]		CK	C0K	1.4 p	$\pm 0.05pF, \pm 0.1pF, \pm 0.25pF$	428	200	0.2±0.02	
MSAST042SCK1R5[WNA01]	TMK042 CK1R5[D-W]		CK	C0K	1.5 p	$\pm 0.05pF, \pm 0.1pF, \pm 0.25pF$	430	200	0.2±0.02	
MSAST042SCK1R6[WNA01]	TMK042 CK1R6[D-W]		CK	C0K	1.6 p	$\pm 0.05pF, \pm 0.1pF, \pm 0.25pF$	432	200	0.2±0.02	
MSAST042SCK1R7[WNA01]	TMK042 CK1R7[D-W]		CK	C0K	1.7 p	$\pm 0.05pF, \pm 0.1pF, \pm 0.25pF$	434	200	0.2±0.02	
MSAST042SCK1R8[WNA01]	TMK042 CK1R8[D-W]		CK	C0K	1.8 p	$\pm 0.05pF, \pm 0.1pF, \pm 0.25pF$	436	200	0.2±0.02	
MSAST042SCK1R9[WNA01]	TMK042 CK1R9[D-W]		CK	C0K	1.9 p	$\pm 0.05pF, \pm 0.1pF, \pm 0.25pF$	438	200	0.2±0.02	
MSAST042SCK020[WNA01]	TMK042 CK020[D-W]		CK	C0K	2 p	$\pm 0.05pF, \pm 0.1pF, \pm 0.25pF$	440	200	0.2±0.02	
MSAST042SCK2R1[WNA01]	TMK042 CK2R1[D-W]		CK	C0K	2.1 p	$\pm 0.05pF, \pm 0.1pF, \pm 0.25pF$	442	200	0.2±0.02	
MSAST042SCK2R2[WNA01]	TMK042 CK2R2[D-W]		CK	C0K	2.2 p	$\pm 0.05pF, \pm 0.1pF, \pm 0.25pF$	444	200	0.2±0.02	
MSAST042SCK2R3[WNA01]	TMK042 CK2R3[D-W]		CK	C0K	2.3 p	$\pm 0.05pF, \pm 0.1pF, \pm 0.25pF$	446	200	0.2±0.02	
MSAST042SCK2R4[WNA01]	TMK042 CK2R4[D-W]		CK	C0K	2.4 p	$\pm 0.05pF, \pm 0.1pF, \pm 0.25pF$	448	200	0.2±0.02	
MSAST042SCK2R5[WNA01]	TMK042 CK2R5[D-W]		CK	C0K	2.5 p	$\pm 0.05pF, \pm 0.1pF, \pm 0.25pF$	450	200	0.2±0.02	
MSAST042SCK2R6[WNA01]	TMK042 CK2R6[D-W]		CK	C0K	2.6 p	$\pm 0.05pF, \pm 0.1pF, \pm 0.25pF$	452	200	0.2±0.02	
MSAST042SCK2R7[WNA01]	TMK042 CK2R7[D-W]		CK	C0K	2.7 p	$\pm 0.05pF, \pm 0.1pF, \pm 0.25pF$	454	200	0.2±0.02	
MSAST042SCK2R8[WNA01]	TMK042 CK2R8[D-W]		CK	C0K	2.8 p	$\pm 0.05pF, \pm 0.1pF, \pm 0.25pF$	456	200	0.2±0.02	
MSAST042SCK2R9[WNA01]	TMK042 CK2R9[D-W]		CK	C0K	2.9 p	$\pm 0.05pF, \pm 0.1pF, \pm 0.25pF$	458	200	0.2±0.02	
MSAST042SCJ030[WNA01]	TMK042 CJ030[D-W]		CJ	C0J	3 p	$\pm 0.05pF, \pm 0.1pF, \pm 0.25pF$	460	200	0.2±0.02	
MSAST042SCJ3R1[WNA01]	TMK042 CJ3R1[D-W]		CJ	C0J	3.1 p	$\pm 0.1pF, \pm 0.25pF$	462	200	0.2±0.02	
MSAST042SCJ3R2[WNA01]	TMK042 CJ3R2[D-W]		CJ	C0J	3.2 p	$\pm 0.1pF, \pm 0.25pF$	464	200	0.2±0.02	
MSAST042SCJ3R3[WNA01]	TMK042 CJ3R3[D-W]		CJ	C0J	3.3 p	$\pm 0.1pF, \pm 0.25pF$	466	200	0.2±0.02	
MSAST042SCJ3R4[WNA01]	TMK042 CJ3R4[D-W]		CJ	C0J	3.4 p	$\pm 0.1pF, \pm 0.25pF$	468	200	0.2±0.02	
MSAST042SCJ3R5[WNA01]	TMK042 CJ3R5[D-W]		CJ	C0J	3.5 p	$\pm 0.1pF, \pm 0.25pF$	470	200	0.2±0.02	
MSAST042SCJ3R6[WNA01]	TMK042 CJ3R6[D-W]		CJ	C0J	3.6 p	$\pm 0.1pF, \pm 0.25pF$	472	200	0.2±0.02	
MSAST042SCJ3R7[WNA01]	TMK042 CJ3R7[D-W]		CJ	C0J	3.7 p	$\pm 0.1pF, \pm 0.25pF$	474	200	0.2±0.02	
MSAST042SCJ3R8[WNA01]	TMK042 CJ3R8[D-W]		CJ	C0J	3.8 p	$\pm 0.1pF, \pm 0.25pF$	476	200	0.2±0.02	
MSAST042SCJ3R9[WNA01]	TMK042 CJ3R9[D-W]		CJ	C0J	3.9 p	$\pm 0.1pF, \pm 0.25pF$	478	200	0.2±0.02	
MSAST042SCH040[WNA01]	TMK042 CH040[D-W]		CH	C0H	4 p	$\pm 0.1pF, \pm 0.25pF$	480	200	0.2±0.02	
MSAST042SCH4R1[WNA01]	TMK042 CH4R1[D-W]		CH	C0H	4.1 p	$\pm 0.1pF, \pm 0.25pF$	482	200	0.2±0.02	
MSAST042SCH4R2[WNA01]	TMK042 CH4R2[D-W]		CH	C0H	4.2 p	$\pm 0.1pF, \pm 0.25pF$	484	200	0.2±0.02	
MSAST042SCH4R3[WNA01]	TMK042 CH4R3[D-W]		CH	C0H	4.3 p	$\pm 0.1pF, \pm 0.25pF$	486	200	0.2±0.02	
MSAST042SCH4R4[WNA01]	TMK042 CH4R4[D-W]		CH	C0H	4.4 p	$\pm 0.1pF, \pm 0.25pF$	488	200	0.2±0.02	
MSAST042SCH4R5[WNA01]	TMK042 CH4R5[D-W]		CH	C0H	4.5 p	$\pm 0.1pF, \pm 0.25pF$	490	200	0.2±0.02	
MSAST042SCH4R6[WNA01]	TMK042 CH4R6[D-W]		CH	C0H	4.6 p	$\pm 0.1pF, \pm 0.25pF$	492	200	0.2±0.02	
MSAST042SCH4R7[WNA01]	TMK042 CH4R7[D-W]		CH	C0H	4.7 p	$\pm 0.1pF, \pm 0.25pF$	494	200	0.2±0.02	
MSAST042SCH4R8[WNA01]	TMK042 CH4R8[D-W]		CH	C0H	4.8 p	$\pm 0.1pF, \pm 0.25pF$	496	200	0.2±0.02	
MSAST042SCH4R9[WNA01]	TMK042 CH4R9[D-W]		CH	C0H	4.9 p	$\pm 0.1pF, \pm 0.25pF$	498	200	0.2±0.02	
MSAST042SCH050[WNA01]	TMK042 CH050[D-W]		CH	C0H	5 p	$\pm 0.1pF, \pm 0.25pF$	500	200	0.2±0.02	
MSAST042SCH5R1[WNA01]	TMK042 CH5R1[D-W]		CH	C0H	5.1 p	$\pm 0.1pF, \pm 0.25pF, \pm 0.5pF$	502	200	0.2±0.02	
MSAST042SCH5R2[WNA01]	TMK042 CH5R2[D-W]		CH	C0H	5.2 p	$\pm 0.1pF, \pm 0.25pF, \pm 0.5pF$	504	200	0.2±0.02	
MSAST042SCH5R3[WNA01]	TMK042 CH5R3[D-W]		CH	C0H	5.3 p	$\pm 0.1pF, \pm 0.25pF, \pm 0.5pF$	506	200	0.2±0.02	
MSAST042SCH5R4[WNA01]	TMK042 CH5R4[D-W]		CH	C0H	5.4 p	$\pm 0.1pF, \pm 0.25pF, \pm 0.5pF$	508	200	0.2±0.02	
MSAST042SCH5R5[WNA01]	TMK042 CH5R5[D-W]	CH	C0H	5.5 p	$\pm 0.1pF, \pm 0.25pF, \pm 0.5pF$	510	200	0.2±0.02		
MSAST042SCH5R6[WNA01]	TMK042 CH5R6[D-W]	CH	C0H	5.6 p	$\pm 0.1pF, \pm 0.25pF, \pm 0.5pF$	512	200	0.2±0.02		
MSAST042SCH5R7[WNA01]	TMK042 CH5R7[D-W]	CH	C0H	5.7 p	$\pm 0.1pF, \pm 0.25pF, \pm 0.5pF$	514	200	0.2±0.02		
MSAST042SCH5R8[WNA01]	TMK042 CH5R8[D-W]	CH	C0H	5.8 p	$\pm 0.1pF, \pm 0.25pF, \pm 0.5pF$	516	200	0.2±0.02		
MSAST042SCH5R9[WNA01]	TMK042 CH5R9[D-W]	CH	C0H	5.9 p	$\pm 0.1pF, \pm 0.25pF, \pm 0.5pF$	518	200	0.2±0.02		
MSAST042SCH060[WNA01]	TMK042 CH060[D-W]	CH	C0H	6 p	$\pm 0.1pF, \pm 0.25pF, \pm 0.5pF$	520	200	0.2±0.02		
MSAST042SCH6R1[WNA01]	TMK042 CH6R1[D-W]	CH	C0H	6.1 p	$\pm 0.1pF, \pm 0.25pF, \pm 0.5pF$	522	200	0.2±0.02		
MSAST042SCH6R2[WNA01]	TMK042 CH6R2[D-W]	CH	C0H	6.2 p	$\pm 0.1pF, \pm 0.25pF, \pm 0.5pF$	524	200	0.2±0.02		
MSAST042SCH6R3[WNA01]	TMK042 CH6R3[D-W]	CH	C0H	6.3 p	$\pm 0.1pF, \pm 0.25pF, \pm 0.5pF$	526	200	0.2±0.02		
MSAST042SCH6R4[WNA01]	TMK042 CH6R4[D-W]	CH	C0H	6.4 p	$\pm 0.1pF, \pm 0.25pF, \pm 0.5pF$	528	200	0.2±0.02		
MSAST042SCH6R5[WNA01]	TMK042 CH6R5[D-W]	CH	C0H	6.5 p	$\pm 0.1pF, \pm 0.25pF, \pm 0.5pF$	530	200	0.2±0.02		
MSAST042SCH6R6[WNA01]	TMK042 CH6R6[D-W]	CH	C0H	6.6 p	$\pm 0.1pF, \pm 0.25pF, \pm 0.5pF$	532	200	0.2±0.02		
MSAST042SCH6R7[WNA01]	TMK042 CH6R7[D-W]	CH	C0H	6.7 p	$\pm 0.1pF, \pm 0.25pF, \pm 0.5pF$	534	200	0.2±0.02		
MSAST042SCH6R8[WNA01]	TMK042 CH6R8[D-W]	CH	C0H	6.8 p	$\pm 0.1pF, \pm 0.25pF, \pm 0.5pF$	536	200	0.2±0.02		
MSAST042SCH6R9[WNA01]	TMK042 CH6R9[D-W]	CH	C0H	6.9 p	$\pm 0.1pF, \pm 0.25pF, \pm 0.5pF$	538	200	0.2±0.02		
MSAST042SCH070[WNA01]	TMK042 CH070[D-W]	CH	C0H	7 p	$\pm 0.1pF, \pm 0.25pF, \pm 0.5pF$	540	200	0.2±0.02		
MSAST042SCH7R1[WNA01]	TMK042 CH7R1[D-W]	CH	C0H	7.1 p	$\pm 0.1pF, \pm 0.25pF, \pm 0.5pF$	542	200	0.2±0.02		
MSAST042SCH7R2[WNA01]	TMK042 CH7R2[D-W]	CH	C0H	7.2 p	$\pm 0.1pF, \pm 0.25pF, \pm 0.5pF$	544	200	0.2±0.02		
MSAST042SCH7R3[WNA01]	TMK042 CH7R3[D-W]	CH	C0H	7.3 p	$\pm 0.1pF, \pm 0.25pF, \pm 0.5pF$	546	200	0.2±0.02		
MSAST042SCH7R4[WNA01]	TMK042 CH7R4[D-W]	CH	C0H	7.4 p	$\pm 0.1pF, \pm 0.25pF, \pm 0.5pF$	548	200	0.2±0.02		
MSAST042SCH7R5[WNA01]	TMK042 CH7R5[D-W]	CH	C0H	7.5 p	$\pm 0.1pF, \pm 0.25pF, \pm 0.5pF$	550	200	0.2±0.02		
MSAST042SCH7R6[WNA01]	TMK042 CH7R6[D-W]	CH	C0H	7.6 p	$\pm 0.1pF, \pm 0.25pF, \pm 0.5pF$	552	200	0.2±0.02		
MSAST042SCH7R7[WNA01]	TMK042 CH7R7[D-W]	CH	C0H	7.7 p	$\pm 0.1pF, \pm 0.25pF, \pm 0.5pF$	554	200	0.2±0.02		
MSAST042SCH7R8[WNA01]	TMK042 CH7R8[D-W]	CH	C0H	7.8 p	$\pm 0.1pF, \pm 0.25pF, \pm 0.5pF$	556	200	0.2±0.02		
MSAST042SCH7R9[WNA01]	TMK042 CH7R9[D-W]	CH	C0H	7.9 p	$\pm 0.1pF, \pm 0.25pF, \pm 0.5pF$	558	200	0.2±0.02		
MSAST042SCH080[WNA01]	TMK042 CH080[D-W]	CH	C0H	8 p	$\pm 0.1pF, \pm 0.25pF, \pm 0.5pF$	560	200	0.2±0.02		
MSAST042SCH8R1[WNA01]	TMK042 CH8R1[D-W]	CH	C0H	8.1 p	$\pm 0.1pF, \pm 0.25pF, \pm 0.5pF$	562	200	0.2±0.02		
MSAST042SCH8R2[WNA01]	TMK042 CH8R2[D-W]	CH	C0H	8.2 p	$\pm 0.1pF, \pm 0.25pF, \pm 0.5pF$	564	200	0.2±0.02		
MSAST042SCH8R3[WNA01]	TMK042 CH8R3[D-W]	CH	C0H	8.3 p	$\pm 0.1pF, \pm 0.25pF, \pm 0.5pF$	566	200	0.2±0.02		
MSAST042SCH8R4[WNA01]	TMK042 CH8R4[D-W]	CH	C0H	8.4 p	$\pm 0.1pF, \pm 0.25pF, \pm 0.5pF$	568	200	0.2±0.02		
MSAST042SCH8R5[WNA01]	TMK042 CH8R5[D-W]	CH	C0H	8.5 p	$\pm 0.1pF, \pm 0.25pF, \pm 0.5pF$	570	200	0.2±0.02		
MSAST042SCH8R6[WNA01]	TMK042 CH8R6[D-W]	CH	C0H	8.6 p	$\pm 0.1pF, \pm 0.25pF, \pm 0.5pF$	572	200	0.2±0.02		

▶ This catalog contains the typical specification only due to the limitation of space. When you consider the purchase of our products, please check our specification.
For details of each product (characteristics graph, reliability information, precautions for use, and so on), see our Web site (<http://www.ty-top.com/>).

■ PART NUMBER

New part number	Old part number (for reference)	Rated voltage [V]	Temperature characteristics		Capacitance [F]	Capacitance tolerance	Q (at 1MHz) (min)	HTLT	Thickness ³ [mm]	Note
								Rated voltage x %		
MSAST042SCH8R7□WNA01	TMK042 CH8R7□D-W	25	CH	C0H	8.7 p	±0.1pF, ±0.25pF, ±0.5pF	574	200	0.2±0.02	
MSAST042SCH8R8□WNA01	TMK042 CH8R8□D-W		CH	C0H	8.8 p	±0.1pF, ±0.25pF, ±0.5pF	576	200	0.2±0.02	
MSAST042SCH8R9□WNA01	TMK042 CH8R9□D-W		CH	C0H	8.9 p	±0.1pF, ±0.25pF, ±0.5pF	578	200	0.2±0.02	
MSAST042SCH090□WNA01	TMK042 CH090□D-W		CH	C0H	9 p	±0.1pF, ±0.25pF, ±0.5pF	580	200	0.2±0.02	
MSAST042SCH9R1□WNA01	TMK042 CH9R1□D-W		CH	C0H	9.1 p	±0.1pF, ±0.25pF, ±0.5pF	582	200	0.2±0.02	
MSAST042SCH9R2□WNA01	TMK042 CH9R2□D-W		CH	C0H	9.2 p	±0.1pF, ±0.25pF, ±0.5pF	584	200	0.2±0.02	
MSAST042SCH9R3□WNA01	TMK042 CH9R3□D-W		CH	C0H	9.3 p	±0.1pF, ±0.25pF, ±0.5pF	586	200	0.2±0.02	
MSAST042SCH9R4□WNA01	TMK042 CH9R4□D-W		CH	C0H	9.4 p	±0.1pF, ±0.25pF, ±0.5pF	588	200	0.2±0.02	
MSAST042SCH9R5□WNA01	TMK042 CH9R5□D-W		CH	C0H	9.5 p	±0.1pF, ±0.25pF, ±0.5pF	590	200	0.2±0.02	
MSAST042SCH9R6□WNA01	TMK042 CH9R6□D-W		CH	C0H	9.6 p	±0.1pF, ±0.25pF, ±0.5pF	592	200	0.2±0.02	
MSAST042SCH9R7□WNA01	TMK042 CH9R7□D-W		CH	C0H	9.7 p	±0.1pF, ±0.25pF, ±0.5pF	594	200	0.2±0.02	
MSAST042SCH9R8□WNA01	TMK042 CH9R8□D-W		CH	C0H	9.8 p	±0.1pF, ±0.25pF, ±0.5pF	596	200	0.2±0.02	
MSAST042SCH9R9□WNA01	TMK042 CH9R9□D-W		CH	C0H	9.9 p	±0.1pF, ±0.25pF, ±0.5pF	598	200	0.2±0.02	
MSAST042SCH100DWNA01	TMK042 CH100DD-W		CH	C0H	10 p	±0.5pF	600	200	0.2±0.02	
MSAST042SCH110JWNA01	TMK042 CH110JD-W		CH	C0H	11 p	±5%	620	200	0.2±0.02	
MSAST042SCH120JWNA01	TMK042 CH120JD-W		CH	C0H	12 p	±5%	640	200	0.2±0.02	
MSAST042SCH130JWNA01	TMK042 CH130JD-W		CH	C0H	13 p	±5%	660	200	0.2±0.02	
MSAST042SCH150JWNA01	TMK042 CH150JD-W		CH	C0H	15 p	±5%	700	200	0.2±0.02	
MSAST042SCH160JWNA01	TMK042 CH160JC-W		CH	C0H	16 p	±5%	720	200	0.2±0.02	
MSAST042SCH180JWNA01	TMK042 CH180JC-W		CH	C0H	18 p	±5%	760	200	0.2±0.02	
MSAST042SCH200JWNA01	TMK042 CH200JC-W		CH	C0H	20 p	±5%	800	200	0.2±0.02	
MSAST042SCH220JWNA01	TMK042 CH220JC-W		CH	C0H	22 p	±5%	840	200	0.2±0.02	
MSAST042SCH240JWNA01	TMK042 CH240JC-W		CH	C0H	24 p	±5%	880	200	0.2±0.02	
MSAST042SCH270JWNA01	TMK042 CH270JC-W		CH	C0H	27 p	±5%	940	200	0.2±0.02	
MSAST042SCH300JWNA01	TMK042 CH300JC-W		CH	C0H	30 p	±5%	1000	200	0.2±0.02	
MSAST042SCH330JWNA01	TMK042 CH330JC-W		CH	C0H	33 p	±5%	1000	200	0.2±0.02	
MSAST042SCH360JWNA01	TMK042 CH360JC-W		CH	C0H	36 p	±5%	1000	200	0.2±0.02	
MSAST042SCH390JWNA01	TMK042 CH390JC-W		CH	C0H	39 p	±5%	1000	200	0.2±0.02	
MSAST042SCH430JWNA01	TMK042 CH430JC-W		CH	C0H	43 p	±5%	1000	200	0.2±0.02	
MSAST042SCH470JWNA01	TMK042 CH470JC-W		CH	C0H	47 p	±5%	1000	200	0.2±0.02	
MSAST042SCH510JWNA01	TMK042 CH510JC-W		CH	C0H	51 p	±5%	1000	200	0.2±0.02	
MSAST042SCH560JWNA01	TMK042 CH560JC-W		CH	C0H	56 p	±5%	1000	200	0.2±0.02	
MSAST042SCH620JWNA01	TMK042 CH620JC-W		CH	C0H	62 p	±5%	1000	200	0.2±0.02	
MSAST042SCH680JWNA01	TMK042 CH680JC-W		CH	C0H	68 p	±5%	1000	200	0.2±0.02	
MSAST042SCH750JWNA01	TMK042 CH750JC-W		CH	C0H	75 p	±5%	1000	200	0.2±0.02	
MSAST042SCH820JWNA01	TMK042 CH820JC-W		CH	C0H	82 p	±5%	1000	200	0.2±0.02	
MSAST042SCH910JWNA01	TMK042 CH910JC-W		CH	C0H	91 p	±5%	1000	200	0.2±0.02	
MSAST042SCH101JWNA01	TMK042 CH101JC-W		CH	C0H	100 p	±5%	1000	200	0.2±0.02	

▶ This catalog contains the typical specification only due to the limitation of space. When you consider the purchase of our products, please check our specification.
For details of each product (characteristics graph, reliability information, precautions for use, and so on), see our Web site (<http://www.ty-top.com/>).

■ PART NUMBER

New part number	Old part number (for reference)	Rated voltage [V]	Temperature characteristics	Capacitance [F]	Capacitance tolerance	Q (at 1MHz) (min)	HTLT	Thickness ^{※3} [mm]	Note
							Rated voltage x %		
MSASE042SCK0R4□WNA01	EMK042 CK0R4□D-W	16	CK C0K	0.4 p	±0.05pF, ±0.1pF, ±0.25pF	408	200	0.2±0.02	
MSASE042SCK0R5□WNA01	EMK042 CK0R5□D-W		CK C0K	0.5 p	±0.05pF, ±0.1pF, ±0.25pF	410	200	0.2±0.02	
MSASE042SCK0R6□WNA01	EMK042 CK0R6□D-W		CK C0K	0.6 p	±0.05pF, ±0.1pF, ±0.25pF	412	200	0.2±0.02	
MSASE042SCK0R7□WNA01	EMK042 CK0R7□D-W		CK C0K	0.7 p	±0.05pF, ±0.1pF, ±0.25pF	414	200	0.2±0.02	
MSASE042SCKR75□WNA01	EMK042 CKR75□D-W		CK C0K	0.75 p	±0.05pF, ±0.1pF, ±0.25pF	415	200	0.2±0.02	
MSASE042SCK0R8□WNA01	EMK042 CK0R8□D-W		CK C0K	0.8 p	±0.05pF, ±0.1pF, ±0.25pF	416	200	0.2±0.02	
MSASE042SCK0R9□WNA01	EMK042 CK0R9□D-W		CK C0K	0.9 p	±0.05pF, ±0.1pF, ±0.25pF	418	200	0.2±0.02	
MSASE042SCK010□WNA01	EMK042 CK010□D-W		CK C0K	1 p	±0.05pF, ±0.1pF, ±0.25pF	420	200	0.2±0.02	
MSASE042SCK1R1□WNA01	EMK042 CK1R1□D-W		CK C0K	1.1 p	±0.05pF, ±0.1pF, ±0.25pF	422	200	0.2±0.02	
MSASE042SCK1R2□WNA01	EMK042 CK1R2□D-W		CK C0K	1.2 p	±0.05pF, ±0.1pF, ±0.25pF	424	200	0.2±0.02	
MSASE042SCK1R3□WNA01	EMK042 CK1R3□D-W		CK C0K	1.3 p	±0.05pF, ±0.1pF, ±0.25pF	426	200	0.2±0.02	
MSASE042SCK1R4□WNA01	EMK042 CK1R4□D-W		CK C0K	1.4 p	±0.05pF, ±0.1pF, ±0.25pF	428	200	0.2±0.02	
MSASE042SCK1R5□WNA01	EMK042 CK1R5□D-W		CK C0K	1.5 p	±0.05pF, ±0.1pF, ±0.25pF	430	200	0.2±0.02	
MSASE042SCK1R6□WNA01	EMK042 CK1R6□D-W		CK C0K	1.6 p	±0.05pF, ±0.1pF, ±0.25pF	432	200	0.2±0.02	
MSASE042SCK1R7□WNA01	EMK042 CK1R7□D-W		CK C0K	1.7 p	±0.05pF, ±0.1pF, ±0.25pF	434	200	0.2±0.02	
MSASE042SCK1R8□WNA01	EMK042 CK1R8□D-W		CK C0K	1.8 p	±0.05pF, ±0.1pF, ±0.25pF	436	200	0.2±0.02	
MSASE042SCK1R9□WNA01	EMK042 CK1R9□D-W		CK C0K	1.9 p	±0.05pF, ±0.1pF, ±0.25pF	438	200	0.2±0.02	
MSASE042SCK020□WNA01	EMK042 CK020□D-W		CK C0K	2 p	±0.05pF, ±0.1pF, ±0.25pF	440	200	0.2±0.02	
MSASE042SCK2R1□WNA01	EMK042 CK2R1□D-W		CK C0K	2.1 p	±0.05pF, ±0.1pF, ±0.25pF	442	200	0.2±0.02	
MSASE042SCK2R2□WNA01	EMK042 CK2R2□D-W		CK C0K	2.2 p	±0.05pF, ±0.1pF, ±0.25pF	444	200	0.2±0.02	
MSASE042SCK2R3□WNA01	EMK042 CK2R3□D-W		CK C0K	2.3 p	±0.05pF, ±0.1pF, ±0.25pF	446	200	0.2±0.02	
MSASE042SCK2R4□WNA01	EMK042 CK2R4□D-W		CK C0K	2.4 p	±0.05pF, ±0.1pF, ±0.25pF	448	200	0.2±0.02	
MSASE042SCK2R5□WNA01	EMK042 CK2R5□D-W		CK C0K	2.5 p	±0.05pF, ±0.1pF, ±0.25pF	450	200	0.2±0.02	
MSASE042SCK2R6□WNA01	EMK042 CK2R6□D-W		CK C0K	2.6 p	±0.05pF, ±0.1pF, ±0.25pF	452	200	0.2±0.02	
MSASE042SCK2R7□WNA01	EMK042 CK2R7□D-W		CK C0K	2.7 p	±0.05pF, ±0.1pF, ±0.25pF	454	200	0.2±0.02	
MSASE042SCK2R8□WNA01	EMK042 CK2R8□D-W		CK C0K	2.8 p	±0.05pF, ±0.1pF, ±0.25pF	456	200	0.2±0.02	
MSASE042SCK2R9□WNA01	EMK042 CK2R9□D-W		CK C0K	2.9 p	±0.05pF, ±0.1pF, ±0.25pF	458	200	0.2±0.02	
MSASE042SCJ030□WNA01	EMK042 CJ030□D-W		CJ C0J	3 p	±0.05pF, ±0.1pF, ±0.25pF	460	200	0.2±0.02	
MSASE042SCJ3R1□WNA01	EMK042 CJ3R1□D-W		CJ C0J	3.1 p	±0.1pF, ±0.25pF	462	200	0.2±0.02	
MSASE042SCJ3R2□WNA01	EMK042 CJ3R2□D-W		CJ C0J	3.2 p	±0.1pF, ±0.25pF	464	200	0.2±0.02	
MSASE042SCJ3R3□WNA01	EMK042 CJ3R3□D-W		CJ C0J	3.3 p	±0.1pF, ±0.25pF	466	200	0.2±0.02	
MSASE042SCJ3R4□WNA01	EMK042 CJ3R4□D-W		CJ C0J	3.4 p	±0.1pF, ±0.25pF	468	200	0.2±0.02	
MSASE042SCJ3R5□WNA01	EMK042 CJ3R5□D-W		CJ C0J	3.5 p	±0.1pF, ±0.25pF	470	200	0.2±0.02	
MSASE042SCJ3R6□WNA01	EMK042 CJ3R6□D-W		CJ C0J	3.6 p	±0.1pF, ±0.25pF	472	200	0.2±0.02	
MSASE042SCJ3R7□WNA01	EMK042 CJ3R7□D-W		CJ C0J	3.7 p	±0.1pF, ±0.25pF	474	200	0.2±0.02	
MSASE042SCJ3R8□WNA01	EMK042 CJ3R8□D-W		CJ C0J	3.8 p	±0.1pF, ±0.25pF	476	200	0.2±0.02	
MSASE042SCJ3R9□WNA01	EMK042 CJ3R9□D-W		CJ C0J	3.9 p	±0.1pF, ±0.25pF	478	200	0.2±0.02	
MSASE042SCH040□WNA01	EMK042 CH040□D-W		CH C0H	4 p	±0.1pF, ±0.25pF	480	200	0.2±0.02	
MSASE042SCH4R1□WNA01	EMK042 CH4R1□D-W		CH C0H	4.1 p	±0.1pF, ±0.25pF	482	200	0.2±0.02	
MSASE042SCH4R2□WNA01	EMK042 CH4R2□D-W		CH C0H	4.2 p	±0.1pF, ±0.25pF	484	200	0.2±0.02	
MSASE042SCH4R3□WNA01	EMK042 CH4R3□D-W		CH C0H	4.3 p	±0.1pF, ±0.25pF	486	200	0.2±0.02	
MSASE042SCH4R4□WNA01	EMK042 CH4R4□D-W		CH C0H	4.4 p	±0.1pF, ±0.25pF	488	200	0.2±0.02	
MSASE042SCH4R5□WNA01	EMK042 CH4R5□D-W		CH C0H	4.5 p	±0.1pF, ±0.25pF	490	200	0.2±0.02	
MSASE042SCH4R6□WNA01	EMK042 CH4R6□D-W		CH C0H	4.6 p	±0.1pF, ±0.25pF	492	200	0.2±0.02	
MSASE042SCH4R7□WNA01	EMK042 CH4R7□D-W		CH C0H	4.7 p	±0.1pF, ±0.25pF	494	200	0.2±0.02	
MSASE042SCH4R8□WNA01	EMK042 CH4R8□D-W		CH C0H	4.8 p	±0.1pF, ±0.25pF	496	200	0.2±0.02	
MSASE042SCH4R9□WNA01	EMK042 CH4R9□D-W		CH C0H	4.9 p	±0.1pF, ±0.25pF	498	200	0.2±0.02	
MSASE042SCH050□WNA01	EMK042 CH050□D-W		CH C0H	5 p	±0.1pF, ±0.25pF	500	200	0.2±0.02	
MSASE042SCH5R1□WNA01	EMK042 CH5R1□D-W		CH C0H	5.1 p	±0.1pF, ±0.25pF, ±0.5pF	502	200	0.2±0.02	
MSASE042SCH5R2□WNA01	EMK042 CH5R2□D-W		CH C0H	5.2 p	±0.1pF, ±0.25pF, ±0.5pF	504	200	0.2±0.02	
MSASE042SCH5R3□WNA01	EMK042 CH5R3□D-W		CH C0H	5.3 p	±0.1pF, ±0.25pF, ±0.5pF	506	200	0.2±0.02	
MSASE042SCH5R4□WNA01	EMK042 CH5R4□D-W		CH C0H	5.4 p	±0.1pF, ±0.25pF, ±0.5pF	508	200	0.2±0.02	
MSASE042SCH5R5□WNA01	EMK042 CH5R5□D-W		CH C0H	5.5 p	±0.1pF, ±0.25pF, ±0.5pF	510	200	0.2±0.02	
MSASE042SCH5R6□WNA01	EMK042 CH5R6□D-W		CH C0H	5.6 p	±0.1pF, ±0.25pF, ±0.5pF	512	200	0.2±0.02	
MSASE042SCH5R7□WNA01	EMK042 CH5R7□D-W		CH C0H	5.7 p	±0.1pF, ±0.25pF, ±0.5pF	514	200	0.2±0.02	
MSASE042SCH5R8□WNA01	EMK042 CH5R8□D-W		CH C0H	5.8 p	±0.1pF, ±0.25pF, ±0.5pF	516	200	0.2±0.02	
MSASE042SCH5R9□WNA01	EMK042 CH5R9□D-W		CH C0H	5.9 p	±0.1pF, ±0.25pF, ±0.5pF	518	200	0.2±0.02	
MSASE042SCH060□WNA01	EMK042 CH060□D-W		CH C0H	6 p	±0.1pF, ±0.25pF, ±0.5pF	520	200	0.2±0.02	
MSASE042SCH6R1□WNA01	EMK042 CH6R1□D-W		CH C0H	6.1 p	±0.1pF, ±0.25pF, ±0.5pF	522	200	0.2±0.02	
MSASE042SCH6R2□WNA01	EMK042 CH6R2□D-W		CH C0H	6.2 p	±0.1pF, ±0.25pF, ±0.5pF	524	200	0.2±0.02	
MSASE042SCH6R3□WNA01	EMK042 CH6R3□D-W		CH C0H	6.3 p	±0.1pF, ±0.25pF, ±0.5pF	526	200	0.2±0.02	
MSASE042SCH6R4□WNA01	EMK042 CH6R4□D-W		CH C0H	6.4 p	±0.1pF, ±0.25pF, ±0.5pF	528	200	0.2±0.02	
MSASE042SCH6R5□WNA01	EMK042 CH6R5□D-W		CH C0H	6.5 p	±0.1pF, ±0.25pF, ±0.5pF	530	200	0.2±0.02	
MSASE042SCH6R6□WNA01	EMK042 CH6R6□D-W		CH C0H	6.6 p	±0.1pF, ±0.25pF, ±0.5pF	532	200	0.2±0.02	
MSASE042SCH6R7□WNA01	EMK042 CH6R7□D-W		CH C0H	6.7 p	±0.1pF, ±0.25pF, ±0.5pF	534	200	0.2±0.02	
MSASE042SCH6R8□WNA01	EMK042 CH6R8□D-W		CH C0H	6.8 p	±0.1pF, ±0.25pF, ±0.5pF	536	200	0.2±0.02	
MSASE042SCH6R9□WNA01	EMK042 CH6R9□D-W		CH C0H	6.9 p	±0.1pF, ±0.25pF, ±0.5pF	538	200	0.2±0.02	
MSASE042SCH070□WNA01	EMK042 CH070□D-W		CH C0H	7 p	±0.1pF, ±0.25pF, ±0.5pF	540	200	0.2±0.02	
MSASE042SCH7R1□WNA01	EMK042 CH7R1□D-W		CH C0H	7.1 p	±0.1pF, ±0.25pF, ±0.5pF	542	200	0.2±0.02	
MSASE042SCH7R2□WNA01	EMK042 CH7R2□D-W		CH C0H	7.2 p	±0.1pF, ±0.25pF, ±0.5pF	544	200	0.2±0.02	
MSASE042SCH7R3□WNA01	EMK042 CH7R3□D-W		CH C0H	7.3 p	±0.1pF, ±0.25pF, ±0.5pF	546	200	0.2±0.02	
MSASE042SCH7R4□WNA01	EMK042 CH7R4□D-W		CH C0H	7.4 p	±0.1pF, ±0.25pF, ±0.5pF	548	200	0.2±0.02	
MSASE042SCH7R5□WNA01	EMK042 CH7R5□D-W		CH C0H	7.5 p	±0.1pF, ±0.25pF, ±0.5pF	550	200	0.2±0.02	
MSASE042SCH7R6□WNA01	EMK042 CH7R6□D-W		CH C0H	7.6 p	±0.1pF, ±0.25pF, ±0.5pF	552	200	0.2±0.02	
MSASE042SCH7R7□WNA01	EMK042 CH7R7□D-W		CH C0H	7.7 p	±0.1pF, ±0.25pF, ±0.5pF	554	200	0.2±0.02	
MSASE042SCH7R8□WNA01	EMK042 CH7R8□D-W		CH C0H	7.8 p	±0.1pF, ±0.25pF, ±0.5pF	556	200	0.2±0.02	
MSASE042SCH7R9□WNA01	EMK042 CH7R9□D-W		CH C0H	7.9 p	±0.1pF, ±0.25pF, ±0.5pF	558	200	0.2±0.02	
MSASE042SCH080□WNA01	EMK042 CH080□D-W		CH C0H	8 p	±0.1pF, ±0.25pF, ±0.5pF	560	200	0.2±0.02	
MSASE042SCH8R1□WNA01	EMK042 CH8R1□D-W		CH C0H	8.1 p	±0.1pF, ±0.25pF, ±0.5pF	562	200	0.2±0.02	
MSASE042SCH8R2□WNA01	EMK042 CH8R2□D-W		CH C0H	8.2 p	±0.1pF, ±0.25pF, ±0.5pF	564	200	0.2±0.02	
MSASE042SCH8R3□WNA01	EMK042 CH8R3□D-W		CH C0H	8.3 p	±0.1pF, ±0.25pF, ±0.5pF	566	200	0.2±0.02	
MSASE042SCH8R4□WNA01	EMK042 CH8R4□D-W		CH C0H	8.4 p	±0.1pF, ±0.25pF, ±0.5pF	568	200	0.2±0.02	
MSASE042SCH8R5□WNA01	EMK042 CH8R5□D-W		CH C0H	8.5 p	±0.1pF, ±0.25pF, ±0.5pF	570	200	0.2±0.02	
MSASE042SCH8R6□WNA01	EMK042 CH8R6□D-W		CH C0H	8.6 p	±0.1pF, ±0.25pF, ±0.5pF	572	200	0.2±0.02	
MSASE042SCH8R7□WNA01	EMK042 CH8R7□D-W		CH C0H	8.7 p	±0.1pF, ±0.25pF, ±0.5pF	574	200	0.2±0.02	
MSASE042SCH8R8□WNA01	EMK042 CH8R8□D-W		CH C0H	8.8 p	±0.1pF, ±0.25pF, ±0.5pF	576	200	0.2±0.02	
MSASE042SCH8R9□WNA01	EMK042 CH8R9□D-W		CH C0H	8.9 p	±0.1pF, ±0.25pF, ±0.5pF	578	200	0.2±0.02	

▶ This catalog contains the typical specification only due to the limitation of space. When you consider the purchase of our products, please check our specification.
For details of each product (characteristics graph, reliability information, precautions for use, and so on), see our Web site (<http://www.ty-top.com/>).

PART NUMBER

New part number	Old part number (for reference)	Rated voltage [V]	Temperature characteristics		Capacitance [F]	Capacitance tolerance	Q (at 1MHz) (min)	HTLT	Thickness ³ [mm]	Note
								Rated voltage x %		
MSASE042SCH090□WNA01	EMK042 CH090□D-W	16	CH	C0H	9 p	±0.1pF, ±0.25pF, ±0.5pF	580	200	0.2±0.02	
MSASE042SCH9R1□WNA01	EMK042 CH9R1□D-W		CH	C0H	9.1 p	±0.1pF, ±0.25pF, ±0.5pF	582	200	0.2±0.02	
MSASE042SCH9R2□WNA01	EMK042 CH9R2□D-W		CH	C0H	9.2 p	±0.1pF, ±0.25pF, ±0.5pF	584	200	0.2±0.02	
MSASE042SCH9R3□WNA01	EMK042 CH9R3□D-W		CH	C0H	9.3 p	±0.1pF, ±0.25pF, ±0.5pF	586	200	0.2±0.02	
MSASE042SCH9R4□WNA01	EMK042 CH9R4□D-W		CH	C0H	9.4 p	±0.1pF, ±0.25pF, ±0.5pF	588	200	0.2±0.02	
MSASE042SCH9R5□WNA01	EMK042 CH9R5□D-W		CH	C0H	9.5 p	±0.1pF, ±0.25pF, ±0.5pF	590	200	0.2±0.02	
MSASE042SCH9R6□WNA01	EMK042 CH9R6□D-W		CH	C0H	9.6 p	±0.1pF, ±0.25pF, ±0.5pF	592	200	0.2±0.02	
MSASE042SCH9R7□WNA01	EMK042 CH9R7□D-W		CH	C0H	9.7 p	±0.1pF, ±0.25pF, ±0.5pF	594	200	0.2±0.02	
MSASE042SCH9R8□WNA01	EMK042 CH9R8□D-W		CH	C0H	9.8 p	±0.1pF, ±0.25pF, ±0.5pF	596	200	0.2±0.02	
MSASE042SCH9R9□WNA01	EMK042 CH9R9□D-W		CH	C0H	9.9 p	±0.1pF, ±0.25pF, ±0.5pF	598	200	0.2±0.02	
MSASE042SCH100DWNA01	EMK042 CH100DD-W		CH	C0H	10 p	±0.5pF	600	200	0.2±0.02	
MSASE042SCH110JWNA01	EMK042 CH110JD-W		CH	C0H	11 p	±5%	620	200	0.2±0.02	
MSASE042SCH120JWNA01	EMK042 CH120JD-W		CH	C0H	12 p	±5%	640	200	0.2±0.02	
MSASE042SCH130JWNA01	EMK042 CH130JD-W		CH	C0H	13 p	±5%	660	200	0.2±0.02	
MSASE042SCH150JWNA01	EMK042 CH150JC-W		CH	C0H	15 p	±5%	700	200	0.2±0.02	
MSASE042SCH160JWNA01	EMK042 CH160JC-W		CH	C0H	16 p	±5%	720	200	0.2±0.02	
MSASE042SCH180JWNA01	EMK042 CH180JC-W		CH	C0H	18 p	±5%	760	200	0.2±0.02	
MSASE042SCH200JWNA01	EMK042 CH200JC-W		CH	C0H	20 p	±5%	800	200	0.2±0.02	
MSASE042SCH220JWNA01	EMK042 CH220JC-W		CH	C0H	22 p	±5%	840	200	0.2±0.02	
MSASE042SCH240JWNA01	EMK042 CH240JC-W		CH	C0H	24 p	±5%	880	200	0.2±0.02	
MSASE042SCH270JWNA01	EMK042 CH270JC-W		CH	C0H	27 p	±5%	940	200	0.2±0.02	
MSASE042SCH300JWNA01	EMK042 CH300JC-W		CH	C0H	30 p	±5%	1000	200	0.2±0.02	
MSASE042SCH330JWNA01	EMK042 CH330JC-W		CH	C0H	33 p	±5%	1000	200	0.2±0.02	
MSASE042SCH360JWNA01	EMK042 CH360JC-W		CH	C0H	36 p	±5%	1000	200	0.2±0.02	
MSASE042SCH390JWNA01	EMK042 CH390JC-W		CH	C0H	39 p	±5%	1000	200	0.2±0.02	
MSASE042SCH430JWNA01	EMK042 CH430JC-W		CH	C0H	43 p	±5%	1000	200	0.2±0.02	
MSASE042SCH470JWNA01	EMK042 CH470JC-W		CH	C0H	47 p	±5%	1000	200	0.2±0.02	
MSASE042SCH510JWNA01	EMK042 CH510JC-W		CH	C0H	51 p	±5%	1000	200	0.2±0.02	
MSASE042SCH560JWNA01	EMK042 CH560JC-W		CH	C0H	56 p	±5%	1000	200	0.2±0.02	
MSASE042SCH620JWNA01	EMK042 CH620JC-W		CH	C0H	62 p	±5%	1000	200	0.2±0.02	
MSASE042SCH680JWNA01	EMK042 CH680JC-W		CH	C0H	68 p	±5%	1000	200	0.2±0.02	
MSASE042SCH750JWNA01	EMK042 CH750JC-W		CH	C0H	75 p	±5%	1000	200	0.2±0.02	
MSASE042SCH820JWNA01	EMK042 CH820JC-W		CH	C0H	82 p	±5%	1000	200	0.2±0.02	
MSASE042SCH910JWNA01	EMK042 CH910JC-W		CH	C0H	91 p	±5%	1000	200	0.2±0.02	
MSASE042SCH101JWNA01	EMK042 CH101JC-W		CH	C0H	100 p	±5%	1000	200	0.2±0.02	
MSASE042SCH221JWNA01	EMK042 CH221JC-W		CH	C0H	220 p	±5%	1000	200	0.2±0.02	
MSASE042SCH241JWNA01	EMK042 CH241JC-W		CH	C0H	240 p	±5%	1000	200	0.2±0.02	
MSASE042SCH271JWNA01	EMK042 CH271JC-W		CH	C0H	270 p	±5%	1000	200	0.2±0.02	
MSASE042SCH331JWNA01	EMK042 CH331JC-W		CH	C0H	330 p	±5%	1000	200	0.2±0.02	

▶ This catalog contains the typical specification only due to the limitation of space. When you consider the purchase of our products, please check our specification.
For details of each product (characteristics graph, reliability information, precautions for use, and so on), see our Web site (<http://www.ty-top.com/>).

■ PART NUMBER

New part number	Old part number (for reference)	Rated voltage [V]	Temperature characteristics	Capacitance [F]	Capacitance tolerance	Q (at 1MHz) (min)	HTLT	Thickness ^{※3} [mm]	Note		
							Rated voltage x %				
MSAST042SCG0R4	WNA01	TMK042 CG0R4	D-W	CG	C0G	0.4 p	±0.05pF, ±0.1pF, ±0.25pF	408	200	0.2±0.02	
MSAST042SCG0R5	WNA01	TMK042 CG0R5	D-W	CG	C0G	0.5 p	±0.05pF, ±0.1pF, ±0.25pF	410	200	0.2±0.02	
MSAST042SCG0R6	WNA01	TMK042 CG0R6	D-W	CG	C0G	0.6 p	±0.05pF, ±0.1pF, ±0.25pF	412	200	0.2±0.02	
MSAST042SCG0R7	WNA01	TMK042 CG0R7	D-W	CG	C0G	0.7 p	±0.05pF, ±0.1pF, ±0.25pF	414	200	0.2±0.02	
MSAST042SCG0R75	WNA01	TMK042 CG0R75	D-W	CG	C0G	0.75 p	±0.05pF, ±0.1pF, ±0.25pF	415	200	0.2±0.02	
MSAST042SCG0R8	WNA01	TMK042 CG0R8	D-W	CG	C0G	0.8 p	±0.05pF, ±0.1pF, ±0.25pF	416	200	0.2±0.02	
MSAST042SCG0R9	WNA01	TMK042 CG0R9	D-W	CG	C0G	0.9 p	±0.05pF, ±0.1pF, ±0.25pF	418	200	0.2±0.02	
MSAST042SCG010	WNA01	TMK042 CG010	D-W	CG	C0G	1 p	±0.05pF, ±0.1pF, ±0.25pF	420	200	0.2±0.02	
MSAST042SCG1R1	WNA01	TMK042 CG1R1	D-W	CG	C0G	1.1 p	±0.05pF, ±0.1pF, ±0.25pF	422	200	0.2±0.02	
MSAST042SCG1R2	WNA01	TMK042 CG1R2	D-W	CG	C0G	1.2 p	±0.05pF, ±0.1pF, ±0.25pF	424	200	0.2±0.02	
MSAST042SCG1R3	WNA01	TMK042 CG1R3	D-W	CG	C0G	1.3 p	±0.05pF, ±0.1pF, ±0.25pF	426	200	0.2±0.02	
MSAST042SCG1R4	WNA01	TMK042 CG1R4	D-W	CG	C0G	1.4 p	±0.05pF, ±0.1pF, ±0.25pF	428	200	0.2±0.02	
MSAST042SCG1R5	WNA01	TMK042 CG1R5	D-W	CG	C0G	1.5 p	±0.05pF, ±0.1pF, ±0.25pF	430	200	0.2±0.02	
MSAST042SCG1R6	WNA01	TMK042 CG1R6	D-W	CG	C0G	1.6 p	±0.05pF, ±0.1pF, ±0.25pF	432	200	0.2±0.02	
MSAST042SCG1R7	WNA01	TMK042 CG1R7	D-W	CG	C0G	1.7 p	±0.05pF, ±0.1pF, ±0.25pF	434	200	0.2±0.02	
MSAST042SCG1R8	WNA01	TMK042 CG1R8	D-W	CG	C0G	1.8 p	±0.05pF, ±0.1pF, ±0.25pF	436	200	0.2±0.02	
MSAST042SCG1R9	WNA01	TMK042 CG1R9	D-W	CG	C0G	1.9 p	±0.05pF, ±0.1pF, ±0.25pF	438	200	0.2±0.02	
MSAST042SCG020	WNA01	TMK042 CG020	D-W	CG	C0G	2 p	±0.05pF, ±0.1pF, ±0.25pF	440	200	0.2±0.02	
MSAST042SCG2R1	WNA01	TMK042 CG2R1	D-W	CG	C0G	2.1 p	±0.05pF, ±0.1pF, ±0.25pF	442	200	0.2±0.02	
MSAST042SCG2R2	WNA01	TMK042 CG2R2	D-W	CG	C0G	2.2 p	±0.05pF, ±0.1pF, ±0.25pF	444	200	0.2±0.02	
MSAST042SCG2R3	WNA01	TMK042 CG2R3	D-W	CG	C0G	2.3 p	±0.05pF, ±0.1pF, ±0.25pF	446	200	0.2±0.02	
MSAST042SCG2R4	WNA01	TMK042 CG2R4	D-W	CG	C0G	2.4 p	±0.05pF, ±0.1pF, ±0.25pF	448	200	0.2±0.02	
MSAST042SCG2R5	WNA01	TMK042 CG2R5	D-W	CG	C0G	2.5 p	±0.05pF, ±0.1pF, ±0.25pF	450	200	0.2±0.02	
MSAST042SCG2R6	WNA01	TMK042 CG2R6	D-W	CG	C0G	2.6 p	±0.05pF, ±0.1pF, ±0.25pF	452	200	0.2±0.02	
MSAST042SCG2R7	WNA01	TMK042 CG2R7	D-W	CG	C0G	2.7 p	±0.05pF, ±0.1pF, ±0.25pF	454	200	0.2±0.02	
MSAST042SCG2R8	WNA01	TMK042 CG2R8	D-W	CG	C0G	2.8 p	±0.05pF, ±0.1pF, ±0.25pF	456	200	0.2±0.02	
MSAST042SCG2R9	WNA01	TMK042 CG2R9	D-W	CG	C0G	2.9 p	±0.05pF, ±0.1pF, ±0.25pF	458	200	0.2±0.02	
MSAST042SCG030	WNA01	TMK042 CG030	D-W	CG	C0G	3 p	±0.05pF, ±0.1pF, ±0.25pF	460	200	0.2±0.02	
MSAST042SCG3R1	WNA01	TMK042 CG3R1	D-W	CG	C0G	3.1 p	±0.1pF, ±0.25pF	462	200	0.2±0.02	
MSAST042SCG3R2	WNA01	TMK042 CG3R2	D-W	CG	C0G	3.2 p	±0.1pF, ±0.25pF	464	200	0.2±0.02	
MSAST042SCG3R3	WNA01	TMK042 CG3R3	D-W	CG	C0G	3.3 p	±0.1pF, ±0.25pF	466	200	0.2±0.02	
MSAST042SCG3R4	WNA01	TMK042 CG3R4	D-W	CG	C0G	3.4 p	±0.1pF, ±0.25pF	468	200	0.2±0.02	
MSAST042SCG3R5	WNA01	TMK042 CG3R5	D-W	CG	C0G	3.5 p	±0.1pF, ±0.25pF	470	200	0.2±0.02	
MSAST042SCG3R6	WNA01	TMK042 CG3R6	D-W	CG	C0G	3.6 p	±0.1pF, ±0.25pF	472	200	0.2±0.02	
MSAST042SCG3R7	WNA01	TMK042 CG3R7	D-W	CG	C0G	3.7 p	±0.1pF, ±0.25pF	474	200	0.2±0.02	
MSAST042SCG3R8	WNA01	TMK042 CG3R8	D-W	CG	C0G	3.8 p	±0.1pF, ±0.25pF	476	200	0.2±0.02	
MSAST042SCG3R9	WNA01	TMK042 CG3R9	D-W	CG	C0G	3.9 p	±0.1pF, ±0.25pF	478	200	0.2±0.02	
MSAST042SCG040	WNA01	TMK042 CG040	D-W	CG	C0G	4 p	±0.1pF, ±0.25pF	480	200	0.2±0.02	
MSAST042SCG4R1	WNA01	TMK042 CG4R1	D-W	CG	C0G	4.1 p	±0.1pF, ±0.25pF	482	200	0.2±0.02	
MSAST042SCG4R2	WNA01	TMK042 CG4R2	D-W	CG	C0G	4.2 p	±0.1pF, ±0.25pF	484	200	0.2±0.02	
MSAST042SCG4R3	WNA01	TMK042 CG4R3	D-W	CG	C0G	4.3 p	±0.1pF, ±0.25pF	486	200	0.2±0.02	
MSAST042SCG4R4	WNA01	TMK042 CG4R4	D-W	CG	C0G	4.4 p	±0.1pF, ±0.25pF	488	200	0.2±0.02	
MSAST042SCG4R5	WNA01	TMK042 CG4R5	D-W	CG	C0G	4.5 p	±0.1pF, ±0.25pF	490	200	0.2±0.02	
MSAST042SCG4R6	WNA01	TMK042 CG4R6	D-W	CG	C0G	4.6 p	±0.1pF, ±0.25pF	492	200	0.2±0.02	
MSAST042SCG4R7	WNA01	TMK042 CG4R7	D-W	CG	C0G	4.7 p	±0.1pF, ±0.25pF	494	200	0.2±0.02	
MSAST042SCG4R8	WNA01	TMK042 CG4R8	D-W	CG	C0G	4.8 p	±0.1pF, ±0.25pF	496	200	0.2±0.02	
MSAST042SCG4R9	WNA01	TMK042 CG4R9	D-W	CG	C0G	4.9 p	±0.1pF, ±0.25pF	498	200	0.2±0.02	
MSAST042SCG050	WNA01	TMK042 CG050	D-W	CG	C0G	5 p	±0.1pF, ±0.25pF	500	200	0.2±0.02	
MSAST042SCG5R1	WNA01	TMK042 CG5R1	D-W	CG	C0G	5.1 p	±0.1pF, ±0.25pF, ±0.5pF	502	200	0.2±0.02	
MSAST042SCG5R2	WNA01	TMK042 CG5R2	D-W	CG	C0G	5.2 p	±0.1pF, ±0.25pF, ±0.5pF	504	200	0.2±0.02	
MSAST042SCG5R3	WNA01	TMK042 CG5R3	D-W	CG	C0G	5.3 p	±0.1pF, ±0.25pF, ±0.5pF	506	200	0.2±0.02	
MSAST042SCG5R4	WNA01	TMK042 CG5R4	D-W	CG	C0G	5.4 p	±0.1pF, ±0.25pF, ±0.5pF	508	200	0.2±0.02	
MSAST042SCG5R5	WNA01	TMK042 CG5R5	D-W	CG	C0G	5.5 p	±0.1pF, ±0.25pF, ±0.5pF	510	200	0.2±0.02	
MSAST042SCG5R6	WNA01	TMK042 CG5R6	D-W	CG	C0G	5.6 p	±0.1pF, ±0.25pF, ±0.5pF	512	200	0.2±0.02	
MSAST042SCG5R7	WNA01	TMK042 CG5R7	D-W	CG	C0G	5.7 p	±0.1pF, ±0.25pF, ±0.5pF	514	200	0.2±0.02	
MSAST042SCG5R8	WNA01	TMK042 CG5R8	D-W	CG	C0G	5.8 p	±0.1pF, ±0.25pF, ±0.5pF	516	200	0.2±0.02	
MSAST042SCG5R9	WNA01	TMK042 CG5R9	D-W	CG	C0G	5.9 p	±0.1pF, ±0.25pF, ±0.5pF	518	200	0.2±0.02	
MSAST042SCG060	WNA01	TMK042 CG060	D-W	CG	C0G	6 p	±0.1pF, ±0.25pF, ±0.5pF	520	200	0.2±0.02	
MSAST042SCG6R1	WNA01	TMK042 CG6R1	D-W	CG	C0G	6.1 p	±0.1pF, ±0.25pF, ±0.5pF	522	200	0.2±0.02	
MSAST042SCG6R2	WNA01	TMK042 CG6R2	D-W	CG	C0G	6.2 p	±0.1pF, ±0.25pF, ±0.5pF	524	200	0.2±0.02	
MSAST042SCG6R3	WNA01	TMK042 CG6R3	D-W	CG	C0G	6.3 p	±0.1pF, ±0.25pF, ±0.5pF	526	200	0.2±0.02	
MSAST042SCG6R4	WNA01	TMK042 CG6R4	D-W	CG	C0G	6.4 p	±0.1pF, ±0.25pF, ±0.5pF	528	200	0.2±0.02	
MSAST042SCG6R5	WNA01	TMK042 CG6R5	D-W	CG	C0G	6.5 p	±0.1pF, ±0.25pF, ±0.5pF	530	200	0.2±0.02	
MSAST042SCG6R6	WNA01	TMK042 CG6R6	D-W	CG	C0G	6.6 p	±0.1pF, ±0.25pF, ±0.5pF	532	200	0.2±0.02	
MSAST042SCG6R7	WNA01	TMK042 CG6R7	D-W	CG	C0G	6.7 p	±0.1pF, ±0.25pF, ±0.5pF	534	200	0.2±0.02	
MSAST042SCG6R8	WNA01	TMK042 CG6R8	D-W	CG	C0G	6.8 p	±0.1pF, ±0.25pF, ±0.5pF	536	200	0.2±0.02	
MSAST042SCG6R9	WNA01	TMK042 CG6R9	D-W	CG	C0G	6.9 p	±0.1pF, ±0.25pF, ±0.5pF	538	200	0.2±0.02	
MSAST042SCG070	WNA01	TMK042 CG070	D-W	CG	C0G	7 p	±0.1pF, ±0.25pF, ±0.5pF	540	200	0.2±0.02	
MSAST042SCG7R1	WNA01	TMK042 CG7R1	D-W	CG	C0G	7.1 p	±0.1pF, ±0.25pF, ±0.5pF	542	200	0.2±0.02	
MSAST042SCG7R2	WNA01	TMK042 CG7R2	D-W	CG	C0G	7.2 p	±0.1pF, ±0.25pF, ±0.5pF	544	200	0.2±0.02	
MSAST042SCG7R3	WNA01	TMK042 CG7R3	D-W	CG	C0G	7.3 p	±0.1pF, ±0.25pF, ±0.5pF	546	200	0.2±0.02	
MSAST042SCG7R4	WNA01	TMK042 CG7R4	D-W	CG	C0G	7.4 p	±0.1pF, ±0.25pF, ±0.5pF	548	200	0.2±0.02	
MSAST042SCG7R5	WNA01	TMK042 CG7R5	D-W	CG	C0G	7.5 p	±0.1pF, ±0.25pF, ±0.5pF	550	200	0.2±0.02	
MSAST042SCG7R6	WNA01	TMK042 CG7R6	D-W	CG	C0G	7.6 p	±0.1pF, ±0.25pF, ±0.5pF	552	200	0.2±0.02	
MSAST042SCG7R7	WNA01	TMK042 CG7R7	D-W	CG	C0G	7.7 p	±0.1pF, ±0.25pF, ±0.5pF	554	200	0.2±0.02	
MSAST042SCG7R8	WNA01	TMK042 CG7R8	D-W	CG	C0G	7.8 p	±0.1pF, ±0.25pF, ±0.5pF	556	200	0.2±0.02	
MSAST042SCG7R9	WNA01	TMK042 CG7R9	D-W	CG	C0G	7.9 p	±0.1pF, ±0.25pF, ±0.5pF	558	200	0.2±0.02	
MSAST042SCG080	WNA01	TMK042 CG080	D-W	CG	C0G	8 p	±0.1pF, ±0.25pF, ±0.5pF	560	200	0.2±0.02	
MSAST042SCG8R1	WNA01	TMK042 CG8R1	D-W	CG	C0G	8.1 p	±0.1pF, ±0.25pF, ±0.5pF	562	200	0.2±0.02	
MSAST042SCG8R2	WNA01	TMK042 CG8R2	D-W	CG	C0G	8.2 p	±0.1pF, ±0.25pF, ±0.5pF	564	200	0.2±0.02	
MSAST042SCG8R3	WNA01	TMK042 CG8R3	D-W	CG	C0G	8.3 p	±0.1pF, ±0.25pF, ±0.5pF	566	200	0.2±0.02	
MSAST042SCG8R4	WNA01	TMK042 CG8R4	D-W	CG	C0G	8.4 p	±0.1pF, ±0.25pF, ±0.5pF	568	200	0.2±0.02	
MSAST042SCG8R5	WNA01	TMK042 CG8R5	D-W	CG	C0G	8.5 p	±0.1pF, ±0.25pF, ±0.5pF	570	200	0.2±0.02	
MSAST042SCG8R6	WNA01	TMK042 CG8R6	D-W	CG	C0G	8.6 p	±0.1pF, ±0.25pF, ±0.5pF	572	200	0.2±0.02	
MSAST042SCG8R7	WNA01	TMK042 CG8R7	D-W	CG	C0G	8.7 p	±0.1pF, ±0.25pF, ±0.5pF	574	200	0.2±0.02	
MSAST042SCG8R8	WNA01	TMK042 CG8R8	D-W	CG	C0G	8.8 p	±0.1pF, ±0.25pF, ±0.5pF	576	200	0.2±0.02	
MSAST042SCG8R9	WNA01	TMK042 CG8R9	D-W	CG	C0G	8.9 p	±0.1pF, ±0.25pF, ±0.5pF	578	200	0.2±0.02	

25

▶ This catalog contains the typical specification only due to the limitation of space. When you consider the purchase of our products, please check our specification.
For details of each product (characteristics graph, reliability information, precautions for use, and so on), see our Web site (<http://www.ty-top.com/>).

PART NUMBER

New part number	Old part number (for reference)	Rated voltage [V]	Temperature characteristics		Capacitance [F]	Capacitance tolerance	Q (at 1MHz) (min)	HTLT	Thickness ³ [mm]	Note
								Rated voltage x %		
MSAST042SCG090□WNA01	TMK042 CG090□D-W	25	CG	C0G	9 p	±0.1pF, ±0.25pF, ±0.5pF	580	200	0.2±0.02	
MSAST042SCG9R1□WNA01	TMK042 CG9R1□D-W		CG	C0G	9.1 p	±0.1pF, ±0.25pF, ±0.5pF	582	200	0.2±0.02	
MSAST042SCG9R2□WNA01	TMK042 CG9R2□D-W		CG	C0G	9.2 p	±0.1pF, ±0.25pF, ±0.5pF	584	200	0.2±0.02	
MSAST042SCG9R3□WNA01	TMK042 CG9R3□D-W		CG	C0G	9.3 p	±0.1pF, ±0.25pF, ±0.5pF	586	200	0.2±0.02	
MSAST042SCG9R4□WNA01	TMK042 CG9R4□D-W		CG	C0G	9.4 p	±0.1pF, ±0.25pF, ±0.5pF	588	200	0.2±0.02	
MSAST042SCG9R5□WNA01	TMK042 CG9R5□D-W		CG	C0G	9.5 p	±0.1pF, ±0.25pF, ±0.5pF	590	200	0.2±0.02	
MSAST042SCG9R6□WNA01	TMK042 CG9R6□D-W		CG	C0G	9.6 p	±0.1pF, ±0.25pF, ±0.5pF	592	200	0.2±0.02	
MSAST042SCG9R7□WNA01	TMK042 CG9R7□D-W		CG	C0G	9.7 p	±0.1pF, ±0.25pF, ±0.5pF	594	200	0.2±0.02	
MSAST042SCG9R8□WNA01	TMK042 CG9R8□D-W		CG	C0G	9.8 p	±0.1pF, ±0.25pF, ±0.5pF	596	200	0.2±0.02	
MSAST042SCG9R9□WNA01	TMK042 CG9R9□D-W		CG	C0G	9.9 p	±0.1pF, ±0.25pF, ±0.5pF	598	200	0.2±0.02	
MSAST042SCG100DWNA01	TMK042 CG100DD-W		CG	C0G	10 p	±0.5pF	600	200	0.2±0.02	
MSAST042SCG110JWNA01	TMK042 CG110JD-W		CG	C0G	11 p	±5%	620	200	0.2±0.02	
MSAST042SCG120JWNA01	TMK042 CG120JD-W		CG	C0G	12 p	±5%	640	200	0.2±0.02	
MSAST042SCG130JWNA01	TMK042 CG130JD-W		CG	C0G	13 p	±5%	660	200	0.2±0.02	
MSAST042SCG150JWNA01	TMK042 CG150JD-W		CG	C0G	15 p	±5%	700	200	0.2±0.02	
MSAST042SCG160JWNA01	TMK042 CG160JC-W		CG	C0G	16 p	±5%	720	200	0.2±0.02	
MSAST042SCG180JWNA01	TMK042 CG180JC-W		CG	C0G	18 p	±5%	760	200	0.2±0.02	
MSAST042SCG200JWNA01	TMK042 CG200JC-W		CG	C0G	20 p	±5%	800	200	0.2±0.02	
MSAST042SCG220JWNA01	TMK042 CG220JC-W		CG	C0G	22 p	±5%	840	200	0.2±0.02	
MSAST042SCG240JWNA01	TMK042 CG240JC-W		CG	C0G	24 p	±5%	880	200	0.2±0.02	
MSAST042SCG270JWNA01	TMK042 CG270JC-W		CG	C0G	27 p	±5%	940	200	0.2±0.02	
MSAST042SCG300JWNA01	TMK042 CG300JC-W		CG	C0G	30 p	±5%	1000	200	0.2±0.02	
MSAST042SCG330JWNA01	TMK042 CG330JC-W		CG	C0G	33 p	±5%	1000	200	0.2±0.02	
MSAST042SCG360JWNA01	TMK042 CG360JC-W		CG	C0G	36 p	±5%	1000	200	0.2±0.02	
MSAST042SCG390JWNA01	TMK042 CG390JC-W		CG	C0G	39 p	±5%	1000	200	0.2±0.02	
MSAST042SCG430JWNA01	TMK042 CG430JC-W		CG	C0G	43 p	±5%	1000	200	0.2±0.02	
MSAST042SCG470JWNA01	TMK042 CG470JC-W		CG	C0G	47 p	±5%	1000	200	0.2±0.02	
MSAST042SCG510JWNA01	TMK042 CG510JC-W		CG	C0G	51 p	±5%	1000	200	0.2±0.02	
MSAST042SCG560JWNA01	TMK042 CG560JC-W		CG	C0G	56 p	±5%	1000	200	0.2±0.02	
MSAST042SCG620JWNA01	TMK042 CG620JC-W		CG	C0G	62 p	±5%	1000	200	0.2±0.02	
MSAST042SCG680JWNA01	TMK042 CG680JC-W		CG	C0G	68 p	±5%	1000	200	0.2±0.02	
MSAST042SCG750JWNA01	TMK042 CG750JC-W		CG	C0G	75 p	±5%	1000	200	0.2±0.02	
MSAST042SCG820JWNA01	TMK042 CG820JC-W		CG	C0G	82 p	±5%	1000	200	0.2±0.02	
MSAST042SCG910JWNA01	TMK042 CG910JC-W		CG	C0G	91 p	±5%	1000	200	0.2±0.02	
MSAST042SCG101JWNA01	TMK042 CG101JC-W		CG	C0G	100 p	±5%	1000	200	0.2±0.02	

► This catalog contains the typical specification only due to the limitation of space. When you consider the purchase of our products, please check our specification.
For details of each product (characteristics graph, reliability information, precautions for use, and so on), see our Web site (<http://www.ty-top.com/>).

■ PART NUMBER

New part number	Old part number (for reference)	Rated voltage [V]	Temperature characteristics	Capacitance [F]	Capacitance tolerance	Q (at 1MHz) (min)	HTLT	Thickness ^{※3} [mm]	Note
							Rated voltage x %		
MSASE042SCG0R4[WNA01	EMK042 CG0R4[D-W		CG C0G	0.4 p	±0.05pF, ±0.1pF, ±0.25pF	408	200	0.2±0.02	
MSASE042SCG0R5[WNA01	EMK042 CG0R5[D-W		CG C0G	0.5 p	±0.05pF, ±0.1pF, ±0.25pF	410	200	0.2±0.02	
MSASE042SCG0R6[WNA01	EMK042 CG0R6[D-W		CG C0G	0.6 p	±0.05pF, ±0.1pF, ±0.25pF	412	200	0.2±0.02	
MSASE042SCG0R7[WNA01	EMK042 CG0R7[D-W		CG C0G	0.7 p	±0.05pF, ±0.1pF, ±0.25pF	414	200	0.2±0.02	
MSASE042SCG0R75[WNA01	EMK042 CGR75[D-W		CG C0G	0.75 p	±0.05pF, ±0.1pF, ±0.25pF	415	200	0.2±0.02	
MSASE042SCG0R8[WNA01	EMK042 CG0R8[D-W		CG C0G	0.8 p	±0.05pF, ±0.1pF, ±0.25pF	416	200	0.2±0.02	
MSASE042SCG0R9[WNA01	EMK042 CG0R9[D-W		CG C0G	0.9 p	±0.05pF, ±0.1pF, ±0.25pF	418	200	0.2±0.02	
MSASE042SCG010[WNA01	EMK042 CG010[D-W		CG C0G	1 p	±0.05pF, ±0.1pF, ±0.25pF	420	200	0.2±0.02	
MSASE042SCG1R1[WNA01	EMK042 CG1R1[D-W		CG C0G	1.1 p	±0.05pF, ±0.1pF, ±0.25pF	422	200	0.2±0.02	
MSASE042SCG1R2[WNA01	EMK042 CG1R2[D-W		CG C0G	1.2 p	±0.05pF, ±0.1pF, ±0.25pF	424	200	0.2±0.02	
MSASE042SCG1R3[WNA01	EMK042 CG1R3[D-W		CG C0G	1.3 p	±0.05pF, ±0.1pF, ±0.25pF	426	200	0.2±0.02	
MSASE042SCG1R4[WNA01	EMK042 CG1R4[D-W		CG C0G	1.4 p	±0.05pF, ±0.1pF, ±0.25pF	428	200	0.2±0.02	
MSASE042SCG1R5[WNA01	EMK042 CG1R5[D-W		CG C0G	1.5 p	±0.05pF, ±0.1pF, ±0.25pF	430	200	0.2±0.02	
MSASE042SCG1R6[WNA01	EMK042 CG1R6[D-W		CG C0G	1.6 p	±0.05pF, ±0.1pF, ±0.25pF	432	200	0.2±0.02	
MSASE042SCG1R7[WNA01	EMK042 CG1R7[D-W		CG C0G	1.7 p	±0.05pF, ±0.1pF, ±0.25pF	434	200	0.2±0.02	
MSASE042SCG1R8[WNA01	EMK042 CG1R8[D-W		CG C0G	1.8 p	±0.05pF, ±0.1pF, ±0.25pF	436	200	0.2±0.02	
MSASE042SCG1R9[WNA01	EMK042 CG1R9[D-W		CG C0G	1.9 p	±0.05pF, ±0.1pF, ±0.25pF	438	200	0.2±0.02	
MSASE042SCG020[WNA01	EMK042 CG020[D-W		CG C0G	2 p	±0.05pF, ±0.1pF, ±0.25pF	440	200	0.2±0.02	
MSASE042SCG2R1[WNA01	EMK042 CG2R1[D-W		CG C0G	2.1 p	±0.05pF, ±0.1pF, ±0.25pF	442	200	0.2±0.02	
MSASE042SCG2R2[WNA01	EMK042 CG2R2[D-W		CG C0G	2.2 p	±0.05pF, ±0.1pF, ±0.25pF	444	200	0.2±0.02	
MSASE042SCG2R3[WNA01	EMK042 CG2R3[D-W		CG C0G	2.3 p	±0.05pF, ±0.1pF, ±0.25pF	446	200	0.2±0.02	
MSASE042SCG2R4[WNA01	EMK042 CG2R4[D-W		CG C0G	2.4 p	±0.05pF, ±0.1pF, ±0.25pF	448	200	0.2±0.02	
MSASE042SCG2R5[WNA01	EMK042 CG2R5[D-W		CG C0G	2.5 p	±0.05pF, ±0.1pF, ±0.25pF	450	200	0.2±0.02	
MSASE042SCG2R6[WNA01	EMK042 CG2R6[D-W		CG C0G	2.6 p	±0.05pF, ±0.1pF, ±0.25pF	452	200	0.2±0.02	
MSASE042SCG2R7[WNA01	EMK042 CG2R7[D-W		CG C0G	2.7 p	±0.05pF, ±0.1pF, ±0.25pF	454	200	0.2±0.02	
MSASE042SCG2R8[WNA01	EMK042 CG2R8[D-W		CG C0G	2.8 p	±0.05pF, ±0.1pF, ±0.25pF	456	200	0.2±0.02	
MSASE042SCG2R9[WNA01	EMK042 CG2R9[D-W		CG C0G	2.9 p	±0.05pF, ±0.1pF, ±0.25pF	458	200	0.2±0.02	
MSASE042SCG030[WNA01	EMK042 CG030[D-W		CG C0G	3 p	±0.05pF, ±0.1pF, ±0.25pF	460	200	0.2±0.02	
MSASE042SCG3R1[WNA01	EMK042 CG3R1[D-W		CG C0G	3.1 p	±0.1pF, ±0.25pF	462	200	0.2±0.02	
MSASE042SCG3R2[WNA01	EMK042 CG3R2[D-W		CG C0G	3.2 p	±0.1pF, ±0.25pF	464	200	0.2±0.02	
MSASE042SCG3R3[WNA01	EMK042 CG3R3[D-W		CG C0G	3.3 p	±0.1pF, ±0.25pF	466	200	0.2±0.02	
MSASE042SCG3R4[WNA01	EMK042 CG3R4[D-W		CG C0G	3.4 p	±0.1pF, ±0.25pF	468	200	0.2±0.02	
MSASE042SCG3R5[WNA01	EMK042 CG3R5[D-W		CG C0G	3.5 p	±0.1pF, ±0.25pF	470	200	0.2±0.02	
MSASE042SCG3R6[WNA01	EMK042 CG3R6[D-W		CG C0G	3.6 p	±0.1pF, ±0.25pF	472	200	0.2±0.02	
MSASE042SCG3R7[WNA01	EMK042 CG3R7[D-W		CG C0G	3.7 p	±0.1pF, ±0.25pF	474	200	0.2±0.02	
MSASE042SCG3R8[WNA01	EMK042 CG3R8[D-W		CG C0G	3.8 p	±0.1pF, ±0.25pF	476	200	0.2±0.02	
MSASE042SCG3R9[WNA01	EMK042 CG3R9[D-W		CG C0G	3.9 p	±0.1pF, ±0.25pF	478	200	0.2±0.02	
MSASE042SCG040[WNA01	EMK042 CG040[D-W		CG C0G	4 p	±0.1pF, ±0.25pF	480	200	0.2±0.02	
MSASE042SCG4R1[WNA01	EMK042 CG4R1[D-W		CG C0G	4.1 p	±0.1pF, ±0.25pF	482	200	0.2±0.02	
MSASE042SCG4R2[WNA01	EMK042 CG4R2[D-W		CG C0G	4.2 p	±0.1pF, ±0.25pF	484	200	0.2±0.02	
MSASE042SCG4R3[WNA01	EMK042 CG4R3[D-W		CG C0G	4.3 p	±0.1pF, ±0.25pF	486	200	0.2±0.02	
MSASE042SCG4R4[WNA01	EMK042 CG4R4[D-W		CG C0G	4.4 p	±0.1pF, ±0.25pF	488	200	0.2±0.02	
MSASE042SCG4R5[WNA01	EMK042 CG4R5[D-W		CG C0G	4.5 p	±0.1pF, ±0.25pF	490	200	0.2±0.02	
MSASE042SCG4R6[WNA01	EMK042 CG4R6[D-W		CG C0G	4.6 p	±0.1pF, ±0.25pF	492	200	0.2±0.02	
MSASE042SCG4R7[WNA01	EMK042 CG4R7[D-W		CG C0G	4.7 p	±0.1pF, ±0.25pF	494	200	0.2±0.02	
MSASE042SCG4R8[WNA01	EMK042 CG4R8[D-W		CG C0G	4.8 p	±0.1pF, ±0.25pF	496	200	0.2±0.02	
MSASE042SCG4R9[WNA01	EMK042 CG4R9[D-W		CG C0G	4.9 p	±0.1pF, ±0.25pF	498	200	0.2±0.02	
MSASE042SCG050[WNA01	EMK042 CG050[D-W		CG C0G	5 p	±0.1pF, ±0.25pF	500	200	0.2±0.02	
MSASE042SCG5R1[WNA01	EMK042 CG5R1[D-W		CG C0G	5.1 p	±0.1pF, ±0.25pF, ±0.5pF	502	200	0.2±0.02	
MSASE042SCG5R2[WNA01	EMK042 CG5R2[D-W		CG C0G	5.2 p	±0.1pF, ±0.25pF, ±0.5pF	504	200	0.2±0.02	
MSASE042SCG5R3[WNA01	EMK042 CG5R3[D-W		CG C0G	5.3 p	±0.1pF, ±0.25pF, ±0.5pF	506	200	0.2±0.02	
MSASE042SCG5R4[WNA01	EMK042 CG5R4[D-W		CG C0G	5.4 p	±0.1pF, ±0.25pF, ±0.5pF	508	200	0.2±0.02	
MSASE042SCG5R5[WNA01	EMK042 CG5R5[D-W		CG C0G	5.5 p	±0.1pF, ±0.25pF, ±0.5pF	510	200	0.2±0.02	
MSASE042SCG5R6[WNA01	EMK042 CG5R6[D-W		CG C0G	5.6 p	±0.1pF, ±0.25pF, ±0.5pF	512	200	0.2±0.02	
MSASE042SCG5R7[WNA01	EMK042 CG5R7[D-W		CG C0G	5.7 p	±0.1pF, ±0.25pF, ±0.5pF	514	200	0.2±0.02	
MSASE042SCG5R8[WNA01	EMK042 CG5R8[D-W		CG C0G	5.8 p	±0.1pF, ±0.25pF, ±0.5pF	516	200	0.2±0.02	
MSASE042SCG5R9[WNA01	EMK042 CG5R9[D-W		CG C0G	5.9 p	±0.1pF, ±0.25pF, ±0.5pF	518	200	0.2±0.02	
MSASE042SCG060[WNA01	EMK042 CG060[D-W		CG C0G	6 p	±0.1pF, ±0.25pF, ±0.5pF	520	200	0.2±0.02	
MSASE042SCG6R1[WNA01	EMK042 CG6R1[D-W		CG C0G	6.1 p	±0.1pF, ±0.25pF, ±0.5pF	522	200	0.2±0.02	
MSASE042SCG6R2[WNA01	EMK042 CG6R2[D-W		CG C0G	6.2 p	±0.1pF, ±0.25pF, ±0.5pF	524	200	0.2±0.02	
MSASE042SCG6R3[WNA01	EMK042 CG6R3[D-W		CG C0G	6.3 p	±0.1pF, ±0.25pF, ±0.5pF	526	200	0.2±0.02	
MSASE042SCG6R4[WNA01	EMK042 CG6R4[D-W		CG C0G	6.4 p	±0.1pF, ±0.25pF, ±0.5pF	528	200	0.2±0.02	
MSASE042SCG6R5[WNA01	EMK042 CG6R5[D-W		CG C0G	6.5 p	±0.1pF, ±0.25pF, ±0.5pF	530	200	0.2±0.02	
MSASE042SCG6R6[WNA01	EMK042 CG6R6[D-W		CG C0G	6.6 p	±0.1pF, ±0.25pF, ±0.5pF	532	200	0.2±0.02	
MSASE042SCG6R7[WNA01	EMK042 CG6R7[D-W		CG C0G	6.7 p	±0.1pF, ±0.25pF, ±0.5pF	534	200	0.2±0.02	
MSASE042SCG6R8[WNA01	EMK042 CG6R8[D-W		CG C0G	6.8 p	±0.1pF, ±0.25pF, ±0.5pF	536	200	0.2±0.02	
MSASE042SCG6R9[WNA01	EMK042 CG6R9[D-W		CG C0G	6.9 p	±0.1pF, ±0.25pF, ±0.5pF	538	200	0.2±0.02	
MSASE042SCG070[WNA01	EMK042 CG070[D-W		CG C0G	7 p	±0.1pF, ±0.25pF, ±0.5pF	540	200	0.2±0.02	
MSASE042SCG7R1[WNA01	EMK042 CG7R1[D-W		CG C0G	7.1 p	±0.1pF, ±0.25pF, ±0.5pF	542	200	0.2±0.02	
MSASE042SCG7R2[WNA01	EMK042 CG7R2[D-W		CG C0G	7.2 p	±0.1pF, ±0.25pF, ±0.5pF	544	200	0.2±0.02	
MSASE042SCG7R3[WNA01	EMK042 CG7R3[D-W		CG C0G	7.3 p	±0.1pF, ±0.25pF, ±0.5pF	546	200	0.2±0.02	
MSASE042SCG7R4[WNA01	EMK042 CG7R4[D-W		CG C0G	7.4 p	±0.1pF, ±0.25pF, ±0.5pF	548	200	0.2±0.02	
MSASE042SCG7R5[WNA01	EMK042 CG7R5[D-W		CG C0G	7.5 p	±0.1pF, ±0.25pF, ±0.5pF	550	200	0.2±0.02	
MSASE042SCG7R6[WNA01	EMK042 CG7R6[D-W		CG C0G	7.6 p	±0.1pF, ±0.25pF, ±0.5pF	552	200	0.2±0.02	
MSASE042SCG7R7[WNA01	EMK042 CG7R7[D-W		CG C0G	7.7 p	±0.1pF, ±0.25pF, ±0.5pF	554	200	0.2±0.02	
MSASE042SCG7R8[WNA01	EMK042 CG7R8[D-W		CG C0G	7.8 p	±0.1pF, ±0.25pF, ±0.5pF	556	200	0.2±0.02	
MSASE042SCG7R9[WNA01	EMK042 CG7R9[D-W		CG C0G	7.9 p	±0.1pF, ±0.25pF, ±0.5pF	558	200	0.2±0.02	
MSASE042SCG080[WNA01	EMK042 CG080[D-W		CG C0G	8 p	±0.1pF, ±0.25pF, ±0.5pF	560	200	0.2±0.02	
MSASE042SCG8R1[WNA01	EMK042 CG8R1[D-W		CG C0G	8.1 p	±0.1pF, ±0.25pF, ±0.5pF	562	200	0.2±0.02	
MSASE042SCG8R2[WNA01	EMK042 CG8R2[D-W		CG C0G	8.2 p	±0.1pF, ±0.25pF, ±0.5pF	564	200	0.2±0.02	
MSASE042SCG8R3[WNA01	EMK042 CG8R3[D-W		CG C0G	8.3 p	±0.1pF, ±0.25pF, ±0.5pF	566	200	0.2±0.02	
MSASE042SCG8R4[WNA01	EMK042 CG8R4[D-W		CG C0G	8.4 p	±0.1pF, ±0.25pF, ±0.5pF	568	200	0.2±0.02	
MSASE042SCG8R5[WNA01	EMK042 CG8R5[D-W		CG C0G	8.5 p	±0.1pF, ±0.25pF, ±0.5pF	570	200	0.2±0.02	
MSASE042SCG8R6[WNA01	EMK042 CG8R6[D-W		CG C0G	8.6 p	±0.1pF, ±0.25pF, ±0.5pF	572	200	0.2±0.02	
MSASE042SCG8R7[WNA01	EMK042 CG8R7[D-W		CG C0G	8.7 p	±0.1pF, ±0.25pF, ±0.5pF	574	200	0.2±0.02	
MSASE042SCG8R8[WNA01	EMK042 CG8R8[D-W		CG C0G	8.8 p	±0.1pF, ±0.25pF, ±0.5pF	576	200	0.2±0.02	
MSASE042SCG8R9[WNA01	EMK042 CG8R9[D-W		CG C0G	8.9 p	±0.1pF, ±0.25pF, ±0.5pF	578	200	0.2±0.02	

16

▶ This catalog contains the typical specification only due to the limitation of space. When you consider the purchase of our products, please check our specification. For details of each product (characteristics graph, reliability information, precautions for use, and so on), see our Web site (<http://www.ty-top.com/>).

PART NUMBER

New part number	Old part number (for reference)	Rated voltage [V]	Temperature characteristics		Capacitance [F]	Capacitance tolerance	Q (at 1MHz) (min)	HTLT	Thickness ³ [mm]	Note
								Rated voltage x %		
MSASE042SCG090WNA01	EMK042 CG090D-W	16	CG	C0G	9 p	±0.1pF, ±0.25pF, ±0.5pF	580	200	0.2±0.02	
MSASE042SCG9R1WNA01	EMK042 CG9R1D-W		CG	C0G	9.1 p	±0.1pF, ±0.25pF, ±0.5pF	582	200	0.2±0.02	
MSASE042SCG9R2WNA01	EMK042 CG9R2D-W		CG	C0G	9.2 p	±0.1pF, ±0.25pF, ±0.5pF	584	200	0.2±0.02	
MSASE042SCG9R3WNA01	EMK042 CG9R3D-W		CG	C0G	9.3 p	±0.1pF, ±0.25pF, ±0.5pF	586	200	0.2±0.02	
MSASE042SCG9R4WNA01	EMK042 CG9R4D-W		CG	C0G	9.4 p	±0.1pF, ±0.25pF, ±0.5pF	588	200	0.2±0.02	
MSASE042SCG9R5WNA01	EMK042 CG9R5D-W		CG	C0G	9.5 p	±0.1pF, ±0.25pF, ±0.5pF	590	200	0.2±0.02	
MSASE042SCG9R6WNA01	EMK042 CG9R6D-W		CG	C0G	9.6 p	±0.1pF, ±0.25pF, ±0.5pF	592	200	0.2±0.02	
MSASE042SCG9R7WNA01	EMK042 CG9R7D-W		CG	C0G	9.7 p	±0.1pF, ±0.25pF, ±0.5pF	594	200	0.2±0.02	
MSASE042SCG9R8WNA01	EMK042 CG9R8D-W		CG	C0G	9.8 p	±0.1pF, ±0.25pF, ±0.5pF	596	200	0.2±0.02	
MSASE042SCG9R9WNA01	EMK042 CG9R9D-W		CG	C0G	9.9 p	±0.1pF, ±0.25pF, ±0.5pF	598	200	0.2±0.02	
MSASE042SCG100DWNA01	EMK042 CG100DD-W		CG	C0G	10 p	±0.5pF	600	200	0.2±0.02	
MSASE042SCG110JWNA01	EMK042 CG110JD-W		CG	C0G	11 p	±5%	620	200	0.2±0.02	
MSASE042SCG120JWNA01	EMK042 CG120JD-W		CG	C0G	12 p	±5%	640	200	0.2±0.02	
MSASE042SCG130JWNA01	EMK042 CG130JD-W		CG	C0G	13 p	±5%	660	200	0.2±0.02	
MSASE042SCG150JWNA01	EMK042 CG150JC-W		CG	C0G	15 p	±5%	700	200	0.2±0.02	
MSASE042SCG160JWNA01	EMK042 CG160JC-W		CG	C0G	16 p	±5%	720	200	0.2±0.02	
MSASE042SCG180JWNA01	EMK042 CG180JC-W		CG	C0G	18 p	±5%	760	200	0.2±0.02	
MSASE042SCG200JWNA01	EMK042 CG200JC-W		CG	C0G	20 p	±5%	800	200	0.2±0.02	
MSASE042SCG220JWNA01	EMK042 CG220JC-W		CG	C0G	22 p	±5%	840	200	0.2±0.02	
MSASE042SCG240JWNA01	EMK042 CG240JC-W		CG	C0G	24 p	±5%	880	200	0.2±0.02	
MSASE042SCG270JWNA01	EMK042 CG270JC-W		CG	C0G	27 p	±5%	940	200	0.2±0.02	
MSASE042SCG300JWNA01	EMK042 CG300JC-W		CG	C0G	30 p	±5%	1000	200	0.2±0.02	
MSASE042SCG330JWNA01	EMK042 CG330JC-W		CG	C0G	33 p	±5%	1000	200	0.2±0.02	
MSASE042SCG360JWNA01	EMK042 CG360JC-W		CG	C0G	36 p	±5%	1000	200	0.2±0.02	
MSASE042SCG390JWNA01	EMK042 CG390JC-W		CG	C0G	39 p	±5%	1000	200	0.2±0.02	
MSASE042SCG430JWNA01	EMK042 CG430JC-W		CG	C0G	43 p	±5%	1000	200	0.2±0.02	
MSASE042SCG470JWNA01	EMK042 CG470JC-W		CG	C0G	47 p	±5%	1000	200	0.2±0.02	
MSASE042SCG510JWNA01	EMK042 CG510JC-W		CG	C0G	51 p	±5%	1000	200	0.2±0.02	
MSASE042SCG560JWNA01	EMK042 CG560JC-W		CG	C0G	56 p	±5%	1000	200	0.2±0.02	
MSASE042SCG620JWNA01	EMK042 CG620JC-W		CG	C0G	62 p	±5%	1000	200	0.2±0.02	
MSASE042SCG680JWNA01	EMK042 CG680JC-W		CG	C0G	68 p	±5%	1000	200	0.2±0.02	
MSASE042SCG750JWNA01	EMK042 CG750JC-W		CG	C0G	75 p	±5%	1000	200	0.2±0.02	
MSASE042SCG820JWNA01	EMK042 CG820JC-W		CG	C0G	82 p	±5%	1000	200	0.2±0.02	
MSASE042SCG910JWNA01	EMK042 CG910JC-W		CG	C0G	91 p	±5%	1000	200	0.2±0.02	
MSASE042SCG101JWNA01	EMK042 CG101JC-W		CG	C0G	100 p	±5%	1000	200	0.2±0.02	
MSASE042SCG221JWNA01	EMK042 CG221JC-W		CG	C0G	220 p	±5%	1000	200	0.2±0.02	
MSASE042SCG241JWNA01	EMK042 CG241JC-W		CG	C0G	240 p	±5%	1000	200	0.2±0.02	
MSASE042SCG271JWNA01	EMK042 CG271JC-W		CG	C0G	270 p	±5%	1000	200	0.2±0.02	
MSASE042SCG331JWNA01	EMK042 CG331JC-W		CG	C0G	330 p	±5%	1000	200	0.2±0.02	

► This catalog contains the typical specification only due to the limitation of space. When you consider the purchase of our products, please check our specification.
For details of each product (characteristics graph, reliability information, precautions for use, and so on), see our Web site (<http://www.ty-top.com/>).

■ PART NUMBER

● 0603TYPE

【Temperature Characteristic $C\Delta : C\Delta/C0\Delta (-55\sim+125^{\circ}C)$ 】 0.3mm thickness

New part number	Old part number (for reference)	Rated voltage [V]	Temperature characteristics		Capacitance [F]	Capacitance tolerance	Q (at 1MHz) (min)	HTLT	Thickness ^{※3} [mm]	Note
								Rated voltage x %		
MSASU063SCH200JFNA01	UMK063 CH200JT-F	50	CH	C0H	20 p	±5%	800	200	0.3±0.03	
MSASU063SCH220JFNA01	UMK063 CH220JT-F		CH	C0H	22 p	±5%	840	200	0.3±0.03	
MSASU063SCH240JFNA01	UMK063 CH240JT-F		CH	C0H	24 p	±5%	880	200	0.3±0.03	
MSASU063SCH270JFNA01	UMK063 CH270JT-F		CH	C0H	27 p	±5%	940	200	0.3±0.03	
MSASU063SCH300JFNA01	UMK063 CH300JT-F		CH	C0H	30 p	±5%	1000	200	0.3±0.03	
MSASU063SCH330JFNA01	UMK063 CH330JT-F		CH	C0H	33 p	±5%	1000	200	0.3±0.03	
MSASU063SCH360JFNA01	UMK063 CH360JT-F		CH	C0H	36 p	±5%	1000	200	0.3±0.03	
MSASU063SCH390JFNA01	UMK063 CH390JT-F		CH	C0H	39 p	±5%	1000	200	0.3±0.03	
MSASU063SCH430JFNA01	UMK063 CH430JT-F		CH	C0H	43 p	±5%	1000	200	0.3±0.03	
MSASU063SCH470JFNA01	UMK063 CH470JT-F		CH	C0H	47 p	±5%	1000	200	0.3±0.03	
MSASU063SCH510JFNA01	UMK063 CH510JT-F		CH	C0H	51 p	±5%	1000	200	0.3±0.03	
MSASU063SCH560JFNA01	UMK063 CH560JT-F		CH	C0H	56 p	±5%	1000	200	0.3±0.03	
MSASU063SCH620JFNA01	UMK063 CH620JT-F		CH	C0H	62 p	±5%	1000	200	0.3±0.03	
MSASU063SCH680JFNA01	UMK063 CH680JT-F		CH	C0H	68 p	±5%	1000	200	0.3±0.03	
MSASU063SCH750JFNA01	UMK063 CH750JT-F		CH	C0H	75 p	±5%	1000	200	0.3±0.03	
MSASU063SCH820JFNA01	UMK063 CH820JT-F		CH	C0H	82 p	±5%	1000	200	0.3±0.03	
MSASU063SCH910JFNA01	UMK063 CH910JT-F		CH	C0H	91 p	±5%	1000	200	0.3±0.03	
MSASU063SCH101JFNA01	UMK063 CH101JT-F		CH	C0H	100 p	±5%	1000	200	0.3±0.03	
MSASU063SCH111JFNA01	UMK063 CH111JT-F		CH	C0H	110 p	±5%	1000	200	0.3±0.03	
MSASU063SCH121JFNA01	UMK063 CH121JT-F		CH	C0H	120 p	±5%	1000	200	0.3±0.03	
MSASU063SCH131JFNA01	UMK063 CH131JT-F		CH	C0H	130 p	±5%	1000	200	0.3±0.03	
MSASU063SCH151JFNA01	UMK063 CH151JT-F		CH	C0H	150 p	±5%	1000	200	0.3±0.03	
MSASU063SCH181JFNA01	UMK063 CH181JT-F		CH	C0H	180 p	±5%	1000	200	0.3±0.03	
MSASU063SCH201JFNA01	UMK063 CH201JT-F		CH	C0H	200 p	±5%	1000	200	0.3±0.03	
MSASU063SCH221JFNA01	UMK063 CH221JT-F		CH	C0H	220 p	±5%	1000	200	0.3±0.03	
MSAST063SCH241JFNA01	TMK063 CH241JT-F		CH	C0H	240 p	±5%	1000	200	0.3±0.03	
MSAST063SCH271JFNA01	TMK063 CH271JT-F		CH	C0H	270 p	±5%	1000	200	0.3±0.03	
MSAST063SCH301JFNA01	TMK063 CH301JT-F		CH	C0H	300 p	±5%	1000	200	0.3±0.03	
MSAST063SCH331JFNA01	TMK063 CH331JT-F		CH	C0H	330 p	±5%	1000	200	0.3±0.03	
MSAST063SCH361JFNA01	TMK063 CH361JT-F		CH	C0H	360 p	±5%	1000	200	0.3±0.03	
MSAST063SCH391JFNA01	TMK063 CH391JT-F		CH	C0H	390 p	±5%	1000	200	0.3±0.03	
MSAST063SCH431JFNA01	TMK063 CH431JT-F		CH	C0H	430 p	±5%	1000	200	0.3±0.03	
MSAST063SCH471JFNA01	TMK063 CH471JT-F		CH	C0H	470 p	±5%	1000	200	0.3±0.03	
MSAST063SCH511JFNA01	TMK063 CH511JT-F		CH	C0H	510 p	±5%	1000	200	0.3±0.03	
MSAST063SCH561JFNA01	TMK063 CH561JT-F		CH	C0H	560 p	±5%	1000	200	0.3±0.03	
MSAST063SCH621JFNA01	TMK063 CH621JT-F	CH	C0H	620 p	±5%	1000	200	0.3±0.03		
MSAST063SCH681JFNA01	TMK063 CH681JT-F	CH	C0H	680 p	±5%	1000	200	0.3±0.03		
MSAST063SCH751JFNA01	TMK063 CH751JT-F	CH	C0H	750 p	±5%	1000	200	0.3±0.03		
MSAST063SCH821JFNA01	TMK063 CH821JT-F	CH	C0H	820 p	±5%	1000	200	0.3±0.03		
MSAST063SCH911JFNA01	TMK063 CH911JT-F	CH	C0H	910 p	±5%	1000	200	0.3±0.03		
MSAST063SCH102JFNA01	TMK063 CH102JT-F	CH	C0H	1000 p	±5%	1000	200	0.3±0.03		
MSASU063SCG200JFNA01	UMK063 CG200JT-F	50	CG	C0G	20 p	±5%	800	200	0.3±0.03	
MSASU063SCG220JFNA01	UMK063 CG220JT-F		CG	C0G	22 p	±5%	840	200	0.3±0.03	
MSASU063SCG240JFNA01	UMK063 CG240JT-F		CG	C0G	24 p	±5%	880	200	0.3±0.03	
MSASU063SCG270JFNA01	UMK063 CG270JT-F		CG	C0G	27 p	±5%	940	200	0.3±0.03	
MSASU063SCG300JFNA01	UMK063 CG300JT-F		CG	C0G	30 p	±5%	1000	200	0.3±0.03	
MSASU063SCG330JFNA01	UMK063 CG330JT-F		CG	C0G	33 p	±5%	1000	200	0.3±0.03	
MSASU063SCG360JFNA01	UMK063 CG360JT-F		CG	C0G	36 p	±5%	1000	200	0.3±0.03	
MSASU063SCG390JFNA01	UMK063 CG390JT-F		CG	C0G	39 p	±5%	1000	200	0.3±0.03	
MSASU063SCG430JFNA01	UMK063 CG430JT-F		CG	C0G	43 p	±5%	1000	200	0.3±0.03	
MSASU063SCG470JFNA01	UMK063 CG470JT-F		CG	C0G	47 p	±5%	1000	200	0.3±0.03	
MSASU063SCG510JFNA01	UMK063 CG510JT-F		CG	C0G	51 p	±5%	1000	200	0.3±0.03	
MSASU063SCG560JFNA01	UMK063 CG560JT-F		CG	C0G	56 p	±5%	1000	200	0.3±0.03	
MSASU063SCG620JFNA01	UMK063 CG620JT-F		CG	C0G	62 p	±5%	1000	200	0.3±0.03	
MSASU063SCG680JFNA01	UMK063 CG680JT-F		CG	C0G	68 p	±5%	1000	200	0.3±0.03	
MSASU063SCG750JFNA01	UMK063 CG750JT-F		CG	C0G	75 p	±5%	1000	200	0.3±0.03	
MSASU063SCG820JFNA01	UMK063 CG820JT-F		CG	C0G	82 p	±5%	1000	200	0.3±0.03	
MSASU063SCG910JFNA01	UMK063 CG910JT-F		CG	C0G	91 p	±5%	1000	200	0.3±0.03	
MSASU063SCG101JFNA01	UMK063 CG101JT-F		CG	C0G	100 p	±5%	1000	200	0.3±0.03	
MSASU063SCG111JFNA01	UMK063 CG111JT-F		CG	C0G	110 p	±5%	1000	200	0.3±0.03	
MSASU063SCG121JFNA01	UMK063 CG121JT-F		CG	C0G	120 p	±5%	1000	200	0.3±0.03	
MSASU063SCG131JFNA01	UMK063 CG131JT-F		CG	C0G	130 p	±5%	1000	200	0.3±0.03	
MSASU063SCG151JFNA01	UMK063 CG151JT-F		CG	C0G	150 p	±5%	1000	200	0.3±0.03	
MSASU063SCG181JFNA01	UMK063 CG181JT-F		CG	C0G	180 p	±5%	1000	200	0.3±0.03	
MSASU063SCG201JFNA01	UMK063 CG201JT-F		CG	C0G	200 p	±5%	1000	200	0.3±0.03	
MSASU063SCG221JFNA01	UMK063 CG221JT-F		CG	C0G	220 p	±5%	1000	200	0.3±0.03	
MSAST063SCG241JFNA01	TMK063 CG241JT-F		CG	C0G	240 p	±5%	1000	200	0.3±0.03	
MSAST063SCG271JFNA01	TMK063 CG271JT-F		CG	C0G	270 p	±5%	1000	200	0.3±0.03	
MSAST063SCG301JFNA01	TMK063 CG301JT-F		CG	C0G	300 p	±5%	1000	200	0.3±0.03	
MSAST063SCG331JFNA01	TMK063 CG331JT-F		CG	C0G	330 p	±5%	1000	200	0.3±0.03	
MSAST063SCG361JFNA01	TMK063 CG361JT-F		CG	C0G	360 p	±5%	1000	200	0.3±0.03	
MSAST063SCG391JFNA01	TMK063 CG391JT-F		CG	C0G	390 p	±5%	1000	200	0.3±0.03	
MSAST063SCG431JFNA01	TMK063 CG431JT-F		CG	C0G	430 p	±5%	1000	200	0.3±0.03	
MSAST063SCG471JFNA01	TMK063 CG471JT-F		CG	C0G	470 p	±5%	1000	200	0.3±0.03	
MSAST063SCG511JFNA01	TMK063 CG511JT-F		CG	C0G	510 p	±5%	1000	200	0.3±0.03	
MSAST063SCG561JFNA01	TMK063 CG561JT-F		CG	C0G	560 p	±5%	1000	200	0.3±0.03	
MSAST063SCG621JFNA01	TMK063 CG621JT-F	CG	C0G	620 p	±5%	1000	200	0.3±0.03		
MSAST063SCG681JFNA01	TMK063 CG681JT-F	CG	C0G	680 p	±5%	1000	200	0.3±0.03		
MSAST063SCG751JFNA01	TMK063 CG751JT-F	CG	C0G	750 p	±5%	1000	200	0.3±0.03		
MSAST063SCG821JFNA01	TMK063 CG821JT-F	CG	C0G	820 p	±5%	1000	200	0.3±0.03		
MSAST063SCG911JFNA01	TMK063 CG911JT-F	CG	C0G	910 p	±5%	1000	200	0.3±0.03		
MSAST063SCG102JFNA01	TMK063 CG102JT-F	CG	C0G	1000 p	±5%	1000	200	0.3±0.03		

▶ This catalog contains the typical specification only due to the limitation of space. When you consider the purchase of our products, please check our specification.
For details of each product (characteristics graph, reliability information, precautions for use, and so on), see our Web site (<http://www.ty-top.com/>).

PART NUMBER

High frequency/Low loss Multilayer Ceramic Capacitors for General Electronic Equipment for Consumer

0201TYPE

【Temperature Characteristic $\Delta C : C\Delta / C0\Delta (-55\sim +125^{\circ}C)$ 】 0.125mm thickness

New part number	Old part number (for reference)	Rated voltage [V]	Temperature characteristics		Capacitance [F]	Capacitance tolerance	Q (at 1GHz) (min)	HTLT	Thickness ^{※3} [mm]	Note
								Rated voltage x %		
MSART021SCH0R2[WRA01]	TVS021 CH0R2[K-W]	25	CH	C0H	0.2 p	$\pm 0.05\text{pF}, \pm 0.1\text{pF}, \pm 0.25\text{pF}$	260	200	0.125±0.013	
MSART021SCH0R3[WRA01]	TVS021 CH0R3[K-W]		CH	C0H	0.3 p	$\pm 0.05\text{pF}, \pm 0.1\text{pF}, \pm 0.25\text{pF}$	260	200	0.125±0.013	
MSART021SCH0R4[WRA01]	TVS021 CH0R4[K-W]		CH	C0H	0.4 p	$\pm 0.05\text{pF}, \pm 0.1\text{pF}, \pm 0.25\text{pF}$	260	200	0.125±0.013	
MSART021SCH0R5[WRA01]	TVS021 CH0R5[K-W]		CH	C0H	0.5 p	$\pm 0.05\text{pF}, \pm 0.1\text{pF}, \pm 0.25\text{pF}$	260	200	0.125±0.013	
MSART021SCH0R6[WRA01]	TVS021 CH0R6[K-W]		CH	C0H	0.6 p	$\pm 0.05\text{pF}, \pm 0.1\text{pF}, \pm 0.25\text{pF}$	260	200	0.125±0.013	
MSART021SCH0R7[WRA01]	TVS021 CH0R7[K-W]		CH	C0H	0.7 p	$\pm 0.05\text{pF}, \pm 0.1\text{pF}, \pm 0.25\text{pF}$	260	200	0.125±0.013	
MSART021SCHR75[WRA01]	TVS021 CHR75[K-W]		CH	C0H	0.75 p	$\pm 0.05\text{pF}, \pm 0.1\text{pF}, \pm 0.25\text{pF}$	260	200	0.125±0.013	
MSART021SCH0R8[WRA01]	TVS021 CH0R8[K-W]		CH	C0H	0.8 p	$\pm 0.05\text{pF}, \pm 0.1\text{pF}, \pm 0.25\text{pF}$	260	200	0.125±0.013	
MSART021SCH0R9[WRA01]	TVS021 CH0R9[K-W]		CH	C0H	0.9 p	$\pm 0.05\text{pF}, \pm 0.1\text{pF}, \pm 0.25\text{pF}$	260	200	0.125±0.013	
MSART021SCH010[WRA01]	TVS021 CH010[K-W]		CH	C0H	1 p	$\pm 0.05\text{pF}, \pm 0.1\text{pF}, \pm 0.25\text{pF}$	260	200	0.125±0.013	
MSART021SCH1R1[WRA01]	TVS021 CH1R1[K-W]		CH	C0H	1.1 p	$\pm 0.05\text{pF}, \pm 0.1\text{pF}, \pm 0.25\text{pF}$	260	200	0.125±0.013	
MSART021SCH1R2[WRA01]	TVS021 CH1R2[K-W]		CH	C0H	1.2 p	$\pm 0.05\text{pF}, \pm 0.1\text{pF}, \pm 0.25\text{pF}$	250	200	0.125±0.013	
MSART021SCH1R3[WRA01]	TVS021 CH1R3[K-W]		CH	C0H	1.3 p	$\pm 0.05\text{pF}, \pm 0.1\text{pF}, \pm 0.25\text{pF}$	230	200	0.125±0.013	
MSART021SCH1R4[WRA01]	TVS021 CH1R4[K-W]		CH	C0H	1.4 p	$\pm 0.05\text{pF}, \pm 0.1\text{pF}, \pm 0.25\text{pF}$	220	200	0.125±0.013	
MSART021SCH1R5[WRA01]	TVS021 CH1R5[K-W]		CH	C0H	1.5 p	$\pm 0.05\text{pF}, \pm 0.1\text{pF}, \pm 0.25\text{pF}$	210	200	0.125±0.013	
MSART021SCH1R6[WRA01]	TVS021 CH1R6[K-W]		CH	C0H	1.6 p	$\pm 0.05\text{pF}, \pm 0.1\text{pF}, \pm 0.25\text{pF}$	190	200	0.125±0.013	
MSART021SCH1R7[WRA01]	TVS021 CH1R7[K-W]		CH	C0H	1.7 p	$\pm 0.05\text{pF}, \pm 0.1\text{pF}, \pm 0.25\text{pF}$	190	200	0.125±0.013	
MSART021SCH1R8[WRA01]	TVS021 CH1R8[K-W]		CH	C0H	1.8 p	$\pm 0.05\text{pF}, \pm 0.1\text{pF}, \pm 0.25\text{pF}$	180	200	0.125±0.013	
MSART021SCH1R9[WRA01]	TVS021 CH1R9[K-W]		CH	C0H	1.9 p	$\pm 0.05\text{pF}, \pm 0.1\text{pF}, \pm 0.25\text{pF}$	170	200	0.125±0.013	
MSART021SCH020[WRA01]	TVS021 CH020[K-W]		CH	C0H	2 p	$\pm 0.05\text{pF}, \pm 0.1\text{pF}, \pm 0.25\text{pF}$	160	200	0.125±0.013	
MSART021SCH2R1[WRA01]	TVS021 CH2R1[K-W]		CH	C0H	2.1 p	$\pm 0.05\text{pF}, \pm 0.1\text{pF}, \pm 0.25\text{pF}$	160	200	0.125±0.013	
MSART021SCH2R2[WRA01]	TVS021 CH2R2[K-W]		CH	C0H	2.2 p	$\pm 0.05\text{pF}, \pm 0.1\text{pF}, \pm 0.25\text{pF}$	150	200	0.125±0.013	
MSART021SCH2R3[WRA01]	TVS021 CH2R3[K-W]		CH	C0H	2.3 p	$\pm 0.05\text{pF}, \pm 0.1\text{pF}, \pm 0.25\text{pF}$	150	200	0.125±0.013	
MSART021SCH2R4[WRA01]	TVS021 CH2R4[K-W]		CH	C0H	2.4 p	$\pm 0.05\text{pF}, \pm 0.1\text{pF}, \pm 0.25\text{pF}$	140	200	0.125±0.013	
MSART021SCH2R5[WRA01]	TVS021 CH2R5[K-W]		CH	C0H	2.5 p	$\pm 0.05\text{pF}, \pm 0.1\text{pF}, \pm 0.25\text{pF}$	140	200	0.125±0.013	
MSART021SCH2R6[WRA01]	TVS021 CH2R6[K-W]		CH	C0H	2.6 p	$\pm 0.05\text{pF}, \pm 0.1\text{pF}, \pm 0.25\text{pF}$	130	200	0.125±0.013	
MSART021SCH2R7[WRA01]	TVS021 CH2R7[K-W]		CH	C0H	2.7 p	$\pm 0.05\text{pF}, \pm 0.1\text{pF}, \pm 0.25\text{pF}$	130	200	0.125±0.013	
MSART021SCH2R8[WRA01]	TVS021 CH2R8[K-W]		CH	C0H	2.8 p	$\pm 0.05\text{pF}, \pm 0.1\text{pF}, \pm 0.25\text{pF}$	120	200	0.125±0.013	
MSART021SCH2R9[WRA01]	TVS021 CH2R9[K-W]		CH	C0H	2.9 p	$\pm 0.05\text{pF}, \pm 0.1\text{pF}, \pm 0.25\text{pF}$	120	200	0.125±0.013	
MSART021SCH030[WRA01]	TVS021 CH030[K-W]		CH	C0H	3 p	$\pm 0.1\text{pF}, \pm 0.25\text{pF}, \pm 0.5\text{pF}$	120	200	0.125±0.013	
MSART021SCH3R1[WRA01]	TVS021 CH3R1[K-W]		CH	C0H	3.1 p	$\pm 0.1\text{pF}, \pm 0.25\text{pF}, \pm 0.5\text{pF}$	110	200	0.125±0.013	
MSART021SCH3R2[WRA01]	TVS021 CH3R2[K-W]		CH	C0H	3.2 p	$\pm 0.1\text{pF}, \pm 0.25\text{pF}, \pm 0.5\text{pF}$	110	200	0.125±0.013	
MSART021SCH3R3[WRA01]	TVS021 CH3R3[K-W]		CH	C0H	3.3 p	$\pm 0.1\text{pF}, \pm 0.25\text{pF}, \pm 0.5\text{pF}$	110	200	0.125±0.013	
MSART021SCH3R4[WRA01]	TVS021 CH3R4[K-W]		CH	C0H	3.4 p	$\pm 0.1\text{pF}, \pm 0.25\text{pF}, \pm 0.5\text{pF}$	110	200	0.125±0.013	
MSART021SCH3R5[WRA01]	TVS021 CH3R5[K-W]		CH	C0H	3.5 p	$\pm 0.1\text{pF}, \pm 0.25\text{pF}, \pm 0.5\text{pF}$	100	200	0.125±0.013	
MSART021SCH3R6[WRA01]	TVS021 CH3R6[K-W]		CH	C0H	3.6 p	$\pm 0.1\text{pF}, \pm 0.25\text{pF}, \pm 0.5\text{pF}$	100	200	0.125±0.013	
MSART021SCH3R7[WRA01]	TVS021 CH3R7[K-W]		CH	C0H	3.7 p	$\pm 0.1\text{pF}, \pm 0.25\text{pF}, \pm 0.5\text{pF}$	100	200	0.125±0.013	
MSART021SCH3R8[WRA01]	TVS021 CH3R8[K-W]		CH	C0H	3.8 p	$\pm 0.1\text{pF}, \pm 0.25\text{pF}, \pm 0.5\text{pF}$	100	200	0.125±0.013	
MSART021SCH3R9[WRA01]	TVS021 CH3R9[K-W]		CH	C0H	3.9 p	$\pm 0.1\text{pF}, \pm 0.25\text{pF}, \pm 0.5\text{pF}$	90	200	0.125±0.013	
MSART021SCH040[WRA01]	TVS021 CH040[K-W]		CH	C0H	4 p	$\pm 0.1\text{pF}, \pm 0.25\text{pF}, \pm 0.5\text{pF}$	90	200	0.125±0.013	
MSART021SCH4R1[WRA01]	TVS021 CH4R1[K-W]		CH	C0H	4.1 p	$\pm 0.1\text{pF}, \pm 0.25\text{pF}, \pm 0.5\text{pF}$	90	200	0.125±0.013	
MSART021SCH4R2[WRA01]	TVS021 CH4R2[K-W]		CH	C0H	4.2 p	$\pm 0.1\text{pF}, \pm 0.25\text{pF}, \pm 0.5\text{pF}$	90	200	0.125±0.013	
MSART021SCH4R3[WRA01]	TVS021 CH4R3[K-W]		CH	C0H	4.3 p	$\pm 0.1\text{pF}, \pm 0.25\text{pF}, \pm 0.5\text{pF}$	90	200	0.125±0.013	
MSART021SCH4R4[WRA01]	TVS021 CH4R4[K-W]		CH	C0H	4.4 p	$\pm 0.1\text{pF}, \pm 0.25\text{pF}, \pm 0.5\text{pF}$	90	200	0.125±0.013	
MSART021SCH4R5[WRA01]	TVS021 CH4R5[K-W]		CH	C0H	4.5 p	$\pm 0.1\text{pF}, \pm 0.25\text{pF}, \pm 0.5\text{pF}$	80	200	0.125±0.013	
MSART021SCH4R6[WRA01]	TVS021 CH4R6[K-W]		CH	C0H	4.6 p	$\pm 0.1\text{pF}, \pm 0.25\text{pF}, \pm 0.5\text{pF}$	80	200	0.125±0.013	
MSART021SCH4R7[WRA01]	TVS021 CH4R7[K-W]		CH	C0H	4.7 p	$\pm 0.1\text{pF}, \pm 0.25\text{pF}, \pm 0.5\text{pF}$	80	200	0.125±0.013	
MSART021SCH4R8[WRA01]	TVS021 CH4R8[K-W]		CH	C0H	4.8 p	$\pm 0.1\text{pF}, \pm 0.25\text{pF}, \pm 0.5\text{pF}$	80	200	0.125±0.013	
MSART021SCH4R9[WRA01]	TVS021 CH4R9[K-W]		CH	C0H	4.9 p	$\pm 0.1\text{pF}, \pm 0.25\text{pF}, \pm 0.5\text{pF}$	80	200	0.125±0.013	
MSART021SCH050[WRA01]	TVS021 CH050[K-W]		CH	C0H	5 p	$\pm 0.1\text{pF}, \pm 0.25\text{pF}, \pm 0.5\text{pF}$	80	200	0.125±0.013	
MSART021SCH5R1[WRA01]	TVS021 CH5R1[K-W]	CH	C0H	5.1 p	$\pm 0.1\text{pF}, \pm 0.25\text{pF}, \pm 0.5\text{pF}$	80	200	0.125±0.013		

▶ This catalog contains the typical specification only due to the limitation of space. When you consider the purchase of our products, please check our specification.
For details of each product (characteristics graph, reliability information, precautions for use, and so on), see our Web site (<http://www.ty-top.com/>).

■ PART NUMBER

New part number	Old part number (for reference)	Rated voltage [V]	Temperature characteristics		Capacitance [F]	Capacitance tolerance	Q (at 1GHz) (min)	HTLT	Thickness ^{*3} [mm]	Note
								Rated voltage x %		
MSARE021SCH5R2□WRA01	EVS021 CH5R2□K-W	16	CH	C0H	5.2 p	±0.1pF, ±0.25pF, ±0.5pF	70	200	0.125±0.013	
MSARE021SCH5R3□WRA01	EVS021 CH5R3□K-W		CH	C0H	5.3 p	±0.1pF, ±0.25pF, ±0.5pF	70	200	0.125±0.013	
MSARE021SCH5R4□WRA01	EVS021 CH5R4□K-W		CH	C0H	5.4 p	±0.1pF, ±0.25pF, ±0.5pF	70	200	0.125±0.013	
MSARE021SCH5R5□WRA01	EVS021 CH5R5□K-W		CH	C0H	5.5 p	±0.1pF, ±0.25pF, ±0.5pF	70	200	0.125±0.013	
MSARE021SCH5R6□WRA01	EVS021 CH5R6□K-W		CH	C0H	5.6 p	±0.1pF, ±0.25pF, ±0.5pF	70	200	0.125±0.013	
MSARE021SCH5R7□WRA01	EVS021 CH5R7□K-W		CH	C0H	5.7 p	±0.1pF, ±0.25pF, ±0.5pF	70	200	0.125±0.013	
MSARE021SCH5R8□WRA01	EVS021 CH5R8□K-W		CH	C0H	5.8 p	±0.1pF, ±0.25pF, ±0.5pF	70	200	0.125±0.013	
MSARE021SCH5R9□WRA01	EVS021 CH5R9□K-W		CH	C0H	5.9 p	±0.1pF, ±0.25pF, ±0.5pF	70	200	0.125±0.013	
MSARE021SCH060□WRA01	EVS021 CH060□K-W		CH	C0H	6 p	±0.1pF, ±0.25pF, ±0.5pF	70	200	0.125±0.013	
MSARE021SCH6R1□WRA01	EVS021 CH6R1□K-W		CH	C0H	6.1 p	±0.1pF, ±0.25pF, ±0.5pF	70	200	0.125±0.013	
MSARE021SCH6R2□WRA01	EVS021 CH6R2□K-W		CH	C0H	6.2 p	±0.1pF, ±0.25pF, ±0.5pF	60	200	0.125±0.013	
MSARE021SCH6R3□WRA01	EVS021 CH6R3□K-W		CH	C0H	6.3 p	±0.1pF, ±0.25pF, ±0.5pF	60	200	0.125±0.013	
MSARE021SCH6R4□WRA01	EVS021 CH6R4□K-W		CH	C0H	6.4 p	±0.1pF, ±0.25pF, ±0.5pF	60	200	0.125±0.013	
MSARE021SCH6R5□WRA01	EVS021 CH6R5□K-W		CH	C0H	6.5 p	±0.1pF, ±0.25pF, ±0.5pF	60	200	0.125±0.013	
MSARE021SCH6R6□WRA01	EVS021 CH6R6□K-W		CH	C0H	6.6 p	±0.1pF, ±0.25pF, ±0.5pF	60	200	0.125±0.013	
MSARE021SCH6R7□WRA01	EVS021 CH6R7□K-W		CH	C0H	6.7 p	±0.1pF, ±0.25pF, ±0.5pF	60	200	0.125±0.013	
MSARE021SCH6R8□WRA01	EVS021 CH6R8□K-W		CH	C0H	6.8 p	±0.1pF, ±0.25pF, ±0.5pF	60	200	0.125±0.013	
MSARE021SCH6R9□WRA01	EVS021 CH6R9□K-W		CH	C0H	6.9 p	±0.1pF, ±0.25pF, ±0.5pF	60	200	0.125±0.013	
MSARE021SCH070□WRA01	EVS021 CH070□K-W		CH	C0H	7 p	±0.1pF, ±0.25pF, ±0.5pF	60	200	0.125±0.013	
MSARE021SCH7R1□WRA01	EVS021 CH7R1□K-W		CH	C0H	7.1 p	±0.1pF, ±0.25pF, ±0.5pF	60	200	0.125±0.013	
MSARE021SCH7R2□WRA01	EVS021 CH7R2□K-W		CH	C0H	7.2 p	±0.1pF, ±0.25pF, ±0.5pF	60	200	0.125±0.013	
MSARE021SCH7R3□WRA01	EVS021 CH7R3□K-W		CH	C0H	7.3 p	±0.1pF, ±0.25pF, ±0.5pF	60	200	0.125±0.013	
MSARE021SCH7R4□WRA01	EVS021 CH7R4□K-W		CH	C0H	7.4 p	±0.1pF, ±0.25pF, ±0.5pF	60	200	0.125±0.013	
MSARE021SCH7R5□WRA01	EVS021 CH7R5□K-W		CH	C0H	7.5 p	±0.1pF, ±0.25pF, ±0.5pF	60	200	0.125±0.013	
MSARE021SCH7R6□WRA01	EVS021 CH7R6□K-W		CH	C0H	7.6 p	±0.1pF, ±0.25pF, ±0.5pF	60	200	0.125±0.013	
MSARE021SCH7R7□WRA01	EVS021 CH7R7□K-W		CH	C0H	7.7 p	±0.1pF, ±0.25pF, ±0.5pF	50	200	0.125±0.013	
MSARE021SCH7R8□WRA01	EVS021 CH7R8□K-W		CH	C0H	7.8 p	±0.1pF, ±0.25pF, ±0.5pF	50	200	0.125±0.013	
MSARE021SCH7R9□WRA01	EVS021 CH7R9□K-W		CH	C0H	7.9 p	±0.1pF, ±0.25pF, ±0.5pF	50	200	0.125±0.013	
MSARE021SCH080□WRA01	EVS021 CH080□K-W		CH	C0H	8 p	±0.1pF, ±0.25pF, ±0.5pF	50	200	0.125±0.013	
MSARE021SCH8R1□WRA01	EVS021 CH8R1□K-W		CH	C0H	8.1 p	±0.1pF, ±0.25pF, ±0.5pF	50	200	0.125±0.013	
MSARE021SCH8R2□WRA01	EVS021 CH8R2□K-W		CH	C0H	8.2 p	±0.1pF, ±0.25pF, ±0.5pF	50	200	0.125±0.013	
MSARE021SCH8R3□WRA01	EVS021 CH8R3□K-W		CH	C0H	8.3 p	±0.1pF, ±0.25pF, ±0.5pF	50	200	0.125±0.013	
MSARE021SCH8R4□WRA01	EVS021 CH8R4□K-W		CH	C0H	8.4 p	±0.1pF, ±0.25pF, ±0.5pF	50	200	0.125±0.013	
MSARE021SCH8R5□WRA01	EVS021 CH8R5□K-W		CH	C0H	8.5 p	±0.1pF, ±0.25pF, ±0.5pF	50	200	0.125±0.013	
MSARE021SCH8R6□WRA01	EVS021 CH8R6□K-W		CH	C0H	8.6 p	±0.1pF, ±0.25pF, ±0.5pF	50	200	0.125±0.013	
MSARE021SCH8R7□WRA01	EVS021 CH8R7□K-W		CH	C0H	8.7 p	±0.1pF, ±0.25pF, ±0.5pF	50	200	0.125±0.013	
MSARE021SCH8R8□WRA01	EVS021 CH8R8□K-W		CH	C0H	8.8 p	±0.1pF, ±0.25pF, ±0.5pF	50	200	0.125±0.013	
MSARE021SCH8R9□WRA01	EVS021 CH8R9□K-W		CH	C0H	8.9 p	±0.1pF, ±0.25pF, ±0.5pF	50	200	0.125±0.013	
MSARE021SCH090□WRA01	EVS021 CH090□K-W		CH	C0H	9 p	±0.1pF, ±0.25pF, ±0.5pF	50	200	0.125±0.013	
MSARE021SCH9R1□WRA01	EVS021 CH9R1□K-W		CH	C0H	9.1 p	±0.1pF, ±0.25pF, ±0.5pF	50	200	0.125±0.013	
MSARE021SCH9R2□WRA01	EVS021 CH9R2□K-W		CH	C0H	9.2 p	±0.1pF, ±0.25pF, ±0.5pF	50	200	0.125±0.013	
MSARE021SCH9R3□WRA01	EVS021 CH9R3□K-W		CH	C0H	9.3 p	±0.1pF, ±0.25pF, ±0.5pF	50	200	0.125±0.013	
MSARE021SCH9R4□WRA01	EVS021 CH9R4□K-W		CH	C0H	9.4 p	±0.1pF, ±0.25pF, ±0.5pF	50	200	0.125±0.013	
MSARE021SCH9R5□WRA01	EVS021 CH9R5□K-W		CH	C0H	9.5 p	±0.1pF, ±0.25pF, ±0.5pF	50	200	0.125±0.013	
MSARE021SCH9R6□WRA01	EVS021 CH9R6□K-W		CH	C0H	9.6 p	±0.1pF, ±0.25pF, ±0.5pF	50	200	0.125±0.013	
MSARE021SCH9R7□WRA01	EVS021 CH9R7□K-W		CH	C0H	9.7 p	±0.1pF, ±0.25pF, ±0.5pF	50	200	0.125±0.013	
MSARE021SCH9R8□WRA01	EVS021 CH9R8□K-W		CH	C0H	9.8 p	±0.1pF, ±0.25pF, ±0.5pF	40	200	0.125±0.013	
MSARE021SCH9R9□WRA01	EVS021 CH9R9□K-W		CH	C0H	9.9 p	±0.1pF, ±0.25pF, ±0.5pF	40	200	0.125±0.013	
MSARE021SCH100□WRA01	EVS021 CH100□K-W		CH	C0H	10 p	±2%, ±5%	50	200	0.125±0.013	

▶ This catalog contains the typical specification only due to the limitation of space. When you consider the purchase of our products, please check our specification.
 For details of each product (characteristics graph, reliability information, precautions for use, and so on), see our Web site (<http://www.ty-top.com/>).

■ PART NUMBER

New part number	Old part number (for reference)	Rated voltage [V]	Temperature characteristics		Capacitance [F]	Capacitance tolerance	Q (at 1GHz) (min)	HTLT	Thickness ^{*3} [mm]	Note
								Rated voltage x %		
MSART021SCG0R2[WRA01	TVS021 CG0R2[K-W	25	CG	C0G	0.2 p	±0.05pF, ±0.1pF, ±0.25pF	260	200	0.125±0.013	
MSART021SCG0R3[WRA01	TVS021 CG0R3[K-W		CG	C0G	0.3 p	±0.05pF, ±0.1pF, ±0.25pF	260	200	0.125±0.013	
MSART021SCG0R4[WRA01	TVS021 CG0R4[K-W		CG	C0G	0.4 p	±0.05pF, ±0.1pF, ±0.25pF	260	200	0.125±0.013	
MSART021SCG0R5[WRA01	TVS021 CG0R5[K-W		CG	C0G	0.5 p	±0.05pF, ±0.1pF, ±0.25pF	260	200	0.125±0.013	
MSART021SCG0R6[WRA01	TVS021 CG0R6[K-W		CG	C0G	0.6 p	±0.05pF, ±0.1pF, ±0.25pF	260	200	0.125±0.013	
MSART021SCG0R7[WRA01	TVS021 CG0R7[K-W		CG	C0G	0.7 p	±0.05pF, ±0.1pF, ±0.25pF	260	200	0.125±0.013	
MSART021SCGR75[WRA01	TVS021 CGR75[K-W		CG	C0G	0.75 p	±0.05pF, ±0.1pF, ±0.25pF	260	200	0.125±0.013	
MSART021SCG0R8[WRA01	TVS021 CG0R8[K-W		CG	C0G	0.8 p	±0.05pF, ±0.1pF, ±0.25pF	260	200	0.125±0.013	
MSART021SCG0R9[WRA01	TVS021 CG0R9[K-W		CG	C0G	0.9 p	±0.05pF, ±0.1pF, ±0.25pF	260	200	0.125±0.013	
MSART021SCG010[WRA01	TVS021 CG010[K-W		CG	C0G	1 p	±0.05pF, ±0.1pF, ±0.25pF	260	200	0.125±0.013	
MSART021SCG1R1[WRA01	TVS021 CG1R1[K-W		CG	C0G	1.1 p	±0.05pF, ±0.1pF, ±0.25pF	260	200	0.125±0.013	
MSART021SCG1R2[WRA01	TVS021 CG1R2[K-W		CG	C0G	1.2 p	±0.05pF, ±0.1pF, ±0.25pF	250	200	0.125±0.013	
MSART021SCG1R3[WRA01	TVS021 CG1R3[K-W		CG	C0G	1.3 p	±0.05pF, ±0.1pF, ±0.25pF	230	200	0.125±0.013	
MSART021SCG1R4[WRA01	TVS021 CG1R4[K-W		CG	C0G	1.4 p	±0.05pF, ±0.1pF, ±0.25pF	220	200	0.125±0.013	
MSART021SCG1R5[WRA01	TVS021 CG1R5[K-W		CG	C0G	1.5 p	±0.05pF, ±0.1pF, ±0.25pF	210	200	0.125±0.013	
MSART021SCG1R6[WRA01	TVS021 CG1R6[K-W		CG	C0G	1.6 p	±0.05pF, ±0.1pF, ±0.25pF	190	200	0.125±0.013	
MSART021SCG1R7[WRA01	TVS021 CG1R7[K-W		CG	C0G	1.7 p	±0.05pF, ±0.1pF, ±0.25pF	190	200	0.125±0.013	
MSART021SCG1R8[WRA01	TVS021 CG1R8[K-W		CG	C0G	1.8 p	±0.05pF, ±0.1pF, ±0.25pF	180	200	0.125±0.013	
MSART021SCG1R9[WRA01	TVS021 CG1R9[K-W		CG	C0G	1.9 p	±0.05pF, ±0.1pF, ±0.25pF	170	200	0.125±0.013	
MSART021SCG020[WRA01	TVS021 CG020[K-W		CG	C0G	2 p	±0.05pF, ±0.1pF, ±0.25pF	160	200	0.125±0.013	
MSART021SCG2R1[WRA01	TVS021 CG2R1[K-W		CG	C0G	2.1 p	±0.05pF, ±0.1pF, ±0.25pF	160	200	0.125±0.013	
MSART021SCG2R2[WRA01	TVS021 CG2R2[K-W		CG	C0G	2.2 p	±0.05pF, ±0.1pF, ±0.25pF	150	200	0.125±0.013	
MSART021SCG2R3[WRA01	TVS021 CG2R3[K-W		CG	C0G	2.3 p	±0.05pF, ±0.1pF, ±0.25pF	150	200	0.125±0.013	
MSART021SCG2R4[WRA01	TVS021 CG2R4[K-W		CG	C0G	2.4 p	±0.05pF, ±0.1pF, ±0.25pF	140	200	0.125±0.013	
MSART021SCG2R5[WRA01	TVS021 CG2R5[K-W		CG	C0G	2.5 p	±0.05pF, ±0.1pF, ±0.25pF	140	200	0.125±0.013	
MSART021SCG2R6[WRA01	TVS021 CG2R6[K-W		CG	C0G	2.6 p	±0.05pF, ±0.1pF, ±0.25pF	130	200	0.125±0.013	
MSART021SCG2R7[WRA01	TVS021 CG2R7[K-W		CG	C0G	2.7 p	±0.05pF, ±0.1pF, ±0.25pF	130	200	0.125±0.013	
MSART021SCG2R8[WRA01	TVS021 CG2R8[K-W		CG	C0G	2.8 p	±0.05pF, ±0.1pF, ±0.25pF	120	200	0.125±0.013	
MSART021SCG2R9[WRA01	TVS021 CG2R9[K-W		CG	C0G	2.9 p	±0.05pF, ±0.1pF, ±0.25pF	120	200	0.125±0.013	
MSART021SCG030[WRA01	TVS021 CG030[K-W		CG	C0G	3 p	±0.1pF, ±0.25pF, ±0.5pF	120	200	0.125±0.013	
MSART021SCG3R1[WRA01	TVS021 CG3R1[K-W		CG	C0G	3.1 p	±0.1pF, ±0.25pF, ±0.5pF	110	200	0.125±0.013	
MSART021SCG3R2[WRA01	TVS021 CG3R2[K-W		CG	C0G	3.2 p	±0.1pF, ±0.25pF, ±0.5pF	110	200	0.125±0.013	
MSART021SCG3R3[WRA01	TVS021 CG3R3[K-W		CG	C0G	3.3 p	±0.1pF, ±0.25pF, ±0.5pF	110	200	0.125±0.013	
MSART021SCG3R4[WRA01	TVS021 CG3R4[K-W		CG	C0G	3.4 p	±0.1pF, ±0.25pF, ±0.5pF	110	200	0.125±0.013	
MSART021SCG3R5[WRA01	TVS021 CG3R5[K-W		CG	C0G	3.5 p	±0.1pF, ±0.25pF, ±0.5pF	100	200	0.125±0.013	
MSART021SCG3R6[WRA01	TVS021 CG3R6[K-W		CG	C0G	3.6 p	±0.1pF, ±0.25pF, ±0.5pF	100	200	0.125±0.013	
MSART021SCG3R7[WRA01	TVS021 CG3R7[K-W		CG	C0G	3.7 p	±0.1pF, ±0.25pF, ±0.5pF	100	200	0.125±0.013	
MSART021SCG3R8[WRA01	TVS021 CG3R8[K-W		CG	C0G	3.8 p	±0.1pF, ±0.25pF, ±0.5pF	100	200	0.125±0.013	
MSART021SCG3R9[WRA01	TVS021 CG3R9[K-W		CG	C0G	3.9 p	±0.1pF, ±0.25pF, ±0.5pF	90	200	0.125±0.013	
MSART021SCG040[WRA01	TVS021 CG040[K-W		CG	C0G	4 p	±0.1pF, ±0.25pF, ±0.5pF	90	200	0.125±0.013	
MSART021SCG4R1[WRA01	TVS021 CG4R1[K-W		CG	C0G	4.1 p	±0.1pF, ±0.25pF, ±0.5pF	90	200	0.125±0.013	
MSART021SCG4R2[WRA01	TVS021 CG4R2[K-W		CG	C0G	4.2 p	±0.1pF, ±0.25pF, ±0.5pF	90	200	0.125±0.013	
MSART021SCG4R3[WRA01	TVS021 CG4R3[K-W		CG	C0G	4.3 p	±0.1pF, ±0.25pF, ±0.5pF	90	200	0.125±0.013	
MSART021SCG4R4[WRA01	TVS021 CG4R4[K-W		CG	C0G	4.4 p	±0.1pF, ±0.25pF, ±0.5pF	90	200	0.125±0.013	
MSART021SCG4R5[WRA01	TVS021 CG4R5[K-W		CG	C0G	4.5 p	±0.1pF, ±0.25pF, ±0.5pF	80	200	0.125±0.013	
MSART021SCG4R6[WRA01	TVS021 CG4R6[K-W		CG	C0G	4.6 p	±0.1pF, ±0.25pF, ±0.5pF	80	200	0.125±0.013	
MSART021SCG4R7[WRA01	TVS021 CG4R7[K-W		CG	C0G	4.7 p	±0.1pF, ±0.25pF, ±0.5pF	80	200	0.125±0.013	
MSART021SCG4R8[WRA01	TVS021 CG4R8[K-W		CG	C0G	4.8 p	±0.1pF, ±0.25pF, ±0.5pF	80	200	0.125±0.013	
MSART021SCG4R9[WRA01	TVS021 CG4R9[K-W		CG	C0G	4.9 p	±0.1pF, ±0.25pF, ±0.5pF	80	200	0.125±0.013	
MSART021SCG050[WRA01	TVS021 CG050[K-W		CG	C0G	5 p	±0.1pF, ±0.25pF, ±0.5pF	80	200	0.125±0.013	
MSART021SCG5R1[WRA01	TVS021 CG5R1[K-W		CG	C0G	5.1 p	±0.1pF, ±0.25pF, ±0.5pF	80	200	0.125±0.013	

* This catalog contains the typical specification only due to the limitation of space. When you consider the purchase of our products, please check our specification.
 For details of each product (characteristics graph, reliability information, precautions for use, and so on), see our Web site (<http://www.ty-top.com/>).

■ PART NUMBER

New part number	Old part number (for reference)	Rated voltage [V]	Temperature characteristics		Capacitance [F]	Capacitance tolerance	Q (at 1GHz) (min)	HTLT	Thickness ^{*3} [mm]	Note
								Rated voltage x %		
MSARE021SCG5R2□WRA01	EVS021 CG5R2□K-W	16	CG	C0G	5.2 p	±0.1pF, ±0.25pF, ±0.5pF	70	200	0.125±0.013	
MSARE021SCG5R3□WRA01	EVS021 CG5R3□K-W		CG	C0G	5.3 p	±0.1pF, ±0.25pF, ±0.5pF	70	200	0.125±0.013	
MSARE021SCG5R4□WRA01	EVS021 CG5R4□K-W		CG	C0G	5.4 p	±0.1pF, ±0.25pF, ±0.5pF	70	200	0.125±0.013	
MSARE021SCG5R5□WRA01	EVS021 CG5R5□K-W		CG	C0G	5.5 p	±0.1pF, ±0.25pF, ±0.5pF	70	200	0.125±0.013	
MSARE021SCG5R6□WRA01	EVS021 CG5R6□K-W		CG	C0G	5.6 p	±0.1pF, ±0.25pF, ±0.5pF	70	200	0.125±0.013	
MSARE021SCG5R7□WRA01	EVS021 CG5R7□K-W		CG	C0G	5.7 p	±0.1pF, ±0.25pF, ±0.5pF	70	200	0.125±0.013	
MSARE021SCG5R8□WRA01	EVS021 CG5R8□K-W		CG	C0G	5.8 p	±0.1pF, ±0.25pF, ±0.5pF	70	200	0.125±0.013	
MSARE021SCG5R9□WRA01	EVS021 CG5R9□K-W		CG	C0G	5.9 p	±0.1pF, ±0.25pF, ±0.5pF	70	200	0.125±0.013	
MSARE021SCG600□WRA01	EVS021 CG600□K-W		CG	C0G	6 p	±0.1pF, ±0.25pF, ±0.5pF	70	200	0.125±0.013	
MSARE021SCG6R1□WRA01	EVS021 CG6R1□K-W		CG	C0G	6.1 p	±0.1pF, ±0.25pF, ±0.5pF	70	200	0.125±0.013	
MSARE021SCG6R2□WRA01	EVS021 CG6R2□K-W		CG	C0G	6.2 p	±0.1pF, ±0.25pF, ±0.5pF	60	200	0.125±0.013	
MSARE021SCG6R3□WRA01	EVS021 CG6R3□K-W		CG	C0G	6.3 p	±0.1pF, ±0.25pF, ±0.5pF	60	200	0.125±0.013	
MSARE021SCG6R4□WRA01	EVS021 CG6R4□K-W		CG	C0G	6.4 p	±0.1pF, ±0.25pF, ±0.5pF	60	200	0.125±0.013	
MSARE021SCG6R5□WRA01	EVS021 CG6R5□K-W		CG	C0G	6.5 p	±0.1pF, ±0.25pF, ±0.5pF	60	200	0.125±0.013	
MSARE021SCG6R6□WRA01	EVS021 CG6R6□K-W		CG	C0G	6.6 p	±0.1pF, ±0.25pF, ±0.5pF	60	200	0.125±0.013	
MSARE021SCG6R7□WRA01	EVS021 CG6R7□K-W		CG	C0G	6.7 p	±0.1pF, ±0.25pF, ±0.5pF	60	200	0.125±0.013	
MSARE021SCG6R8□WRA01	EVS021 CG6R8□K-W		CG	C0G	6.8 p	±0.1pF, ±0.25pF, ±0.5pF	60	200	0.125±0.013	
MSARE021SCG6R9□WRA01	EVS021 CG6R9□K-W		CG	C0G	6.9 p	±0.1pF, ±0.25pF, ±0.5pF	60	200	0.125±0.013	
MSARE021SCG700□WRA01	EVS021 CG700□K-W		CG	C0G	7 p	±0.1pF, ±0.25pF, ±0.5pF	60	200	0.125±0.013	
MSARE021SCG7R1□WRA01	EVS021 CG7R1□K-W		CG	C0G	7.1 p	±0.1pF, ±0.25pF, ±0.5pF	60	200	0.125±0.013	
MSARE021SCG7R2□WRA01	EVS021 CG7R2□K-W		CG	C0G	7.2 p	±0.1pF, ±0.25pF, ±0.5pF	60	200	0.125±0.013	
MSARE021SCG7R3□WRA01	EVS021 CG7R3□K-W		CG	C0G	7.3 p	±0.1pF, ±0.25pF, ±0.5pF	60	200	0.125±0.013	
MSARE021SCG7R4□WRA01	EVS021 CG7R4□K-W		CG	C0G	7.4 p	±0.1pF, ±0.25pF, ±0.5pF	60	200	0.125±0.013	
MSARE021SCG7R5□WRA01	EVS021 CG7R5□K-W		CG	C0G	7.5 p	±0.1pF, ±0.25pF, ±0.5pF	60	200	0.125±0.013	
MSARE021SCG7R6□WRA01	EVS021 CG7R6□K-W		CG	C0G	7.6 p	±0.1pF, ±0.25pF, ±0.5pF	60	200	0.125±0.013	
MSARE021SCG7R7□WRA01	EVS021 CG7R7□K-W		CG	C0G	7.7 p	±0.1pF, ±0.25pF, ±0.5pF	50	200	0.125±0.013	
MSARE021SCG7R8□WRA01	EVS021 CG7R8□K-W		CG	C0G	7.8 p	±0.1pF, ±0.25pF, ±0.5pF	50	200	0.125±0.013	
MSARE021SCG7R9□WRA01	EVS021 CG7R9□K-W		CG	C0G	7.9 p	±0.1pF, ±0.25pF, ±0.5pF	50	200	0.125±0.013	
MSARE021SCG800□WRA01	EVS021 CG800□K-W		CG	C0G	8 p	±0.1pF, ±0.25pF, ±0.5pF	50	200	0.125±0.013	
MSARE021SCG8R1□WRA01	EVS021 CG8R1□K-W		CG	C0G	8.1 p	±0.1pF, ±0.25pF, ±0.5pF	50	200	0.125±0.013	
MSARE021SCG8R2□WRA01	EVS021 CG8R2□K-W		CG	C0G	8.2 p	±0.1pF, ±0.25pF, ±0.5pF	50	200	0.125±0.013	
MSARE021SCG8R3□WRA01	EVS021 CG8R3□K-W		CG	C0G	8.3 p	±0.1pF, ±0.25pF, ±0.5pF	50	200	0.125±0.013	
MSARE021SCG8R4□WRA01	EVS021 CG8R4□K-W		CG	C0G	8.4 p	±0.1pF, ±0.25pF, ±0.5pF	50	200	0.125±0.013	
MSARE021SCG8R5□WRA01	EVS021 CG8R5□K-W		CG	C0G	8.5 p	±0.1pF, ±0.25pF, ±0.5pF	50	200	0.125±0.013	
MSARE021SCG8R6□WRA01	EVS021 CG8R6□K-W		CG	C0G	8.6 p	±0.1pF, ±0.25pF, ±0.5pF	50	200	0.125±0.013	
MSARE021SCG8R7□WRA01	EVS021 CG8R7□K-W		CG	C0G	8.7 p	±0.1pF, ±0.25pF, ±0.5pF	50	200	0.125±0.013	
MSARE021SCG8R8□WRA01	EVS021 CG8R8□K-W		CG	C0G	8.8 p	±0.1pF, ±0.25pF, ±0.5pF	50	200	0.125±0.013	
MSARE021SCG8R9□WRA01	EVS021 CG8R9□K-W		CG	C0G	8.9 p	±0.1pF, ±0.25pF, ±0.5pF	50	200	0.125±0.013	
MSARE021SCG900□WRA01	EVS021 CG900□K-W		CG	C0G	9 p	±0.1pF, ±0.25pF, ±0.5pF	50	200	0.125±0.013	
MSARE021SCG9R1□WRA01	EVS021 CG9R1□K-W		CG	C0G	9.1 p	±0.1pF, ±0.25pF, ±0.5pF	50	200	0.125±0.013	
MSARE021SCG9R2□WRA01	EVS021 CG9R2□K-W		CG	C0G	9.2 p	±0.1pF, ±0.25pF, ±0.5pF	50	200	0.125±0.013	
MSARE021SCG9R3□WRA01	EVS021 CG9R3□K-W		CG	C0G	9.3 p	±0.1pF, ±0.25pF, ±0.5pF	50	200	0.125±0.013	
MSARE021SCG9R4□WRA01	EVS021 CG9R4□K-W		CG	C0G	9.4 p	±0.1pF, ±0.25pF, ±0.5pF	50	200	0.125±0.013	
MSARE021SCG9R5□WRA01	EVS021 CG9R5□K-W		CG	C0G	9.5 p	±0.1pF, ±0.25pF, ±0.5pF	50	200	0.125±0.013	
MSARE021SCG9R6□WRA01	EVS021 CG9R6□K-W		CG	C0G	9.6 p	±0.1pF, ±0.25pF, ±0.5pF	50	200	0.125±0.013	
MSARE021SCG9R7□WRA01	EVS021 CG9R7□K-W		CG	C0G	9.7 p	±0.1pF, ±0.25pF, ±0.5pF	50	200	0.125±0.013	
MSARE021SCG9R8□WRA01	EVS021 CG9R8□K-W		CG	C0G	9.8 p	±0.1pF, ±0.25pF, ±0.5pF	40	200	0.125±0.013	
MSARE021SCG9R9□WRA01	EVS021 CG9R9□K-W		CG	C0G	9.9 p	±0.1pF, ±0.25pF, ±0.5pF	40	200	0.125±0.013	
MSARE021SCG100□WRA01	EVS021 CG100□K-W		CG	C0G	10 p	±2%, ±5%	50	200	0.125±0.013	

* This catalog contains the typical specification only due to the limitation of space. When you consider the purchase of our products, please check our specification.
 For details of each product (characteristics graph, reliability information, precautions for use, and so on), see our Web site (<http://www.ty-top.com/>).

■ PART NUMBER

● 0402TYPE

【Temperature Characteristic $C\Delta : C\Delta/C0\Delta (-55\sim+125^{\circ}C)$ 】 0.2mm thickness

New part number	Old part number (for reference)	Rated voltage [V]	Temperature characteristics		Capacitance [F]	Capacitance tolerance	Q (at 1GHz) (min)	HTLT		Thickness ^{※3} [mm]	Note
								Rated voltage x %			
MSART042SCH0R2[WRA01]	TVS042 CH0R2[C-W]	25	CH	C0H	0.2 p	±0.05pF, ±0.1pF, ±0.25pF	300	300	200	0.2±0.02	
MSART042SCH0R3[WRA01]	TVS042 CH0R3[C-W]		CH	C0H	0.3 p	±0.05pF, ±0.1pF, ±0.25pF	300	200	200	0.2±0.02	
MSART042SCH0R4[WRA01]	TVS042 CH0R4[C-W]		CH	C0H	0.4 p	±0.05pF, ±0.1pF, ±0.25pF	300	200	200	0.2±0.02	
MSART042SCH0R5[WRA01]	TVS042 CH0R5[C-W]		CH	C0H	0.5 p	±0.05pF, ±0.1pF, ±0.25pF	300	200	200	0.2±0.02	
MSART042SCH0R6[WRA01]	TVS042 CH0R6[C-W]		CH	C0H	0.6 p	±0.05pF, ±0.1pF, ±0.25pF	300	200	200	0.2±0.02	
MSART042SCH0R7[WRA01]	TVS042 CH0R7[C-W]		CH	C0H	0.7 p	±0.05pF, ±0.1pF, ±0.25pF	300	200	200	0.2±0.02	
MSART042SCH0R75[WRA01]	TVS042 CHR75[C-W]		CH	C0H	0.75 p	±0.05pF, ±0.1pF, ±0.25pF	300	200	200	0.2±0.02	
MSART042SCH0R8[WRA01]	TVS042 CH0R8[C-W]		CH	C0H	0.8 p	±0.05pF, ±0.1pF, ±0.25pF	300	200	200	0.2±0.02	
MSART042SCH0R9[WRA01]	TVS042 CH0R9[C-W]		CH	C0H	0.9 p	±0.05pF, ±0.1pF, ±0.25pF	300	200	200	0.2±0.02	
MSART042SCH010[WRA01]	TVS042 CH010[C-W]		CH	C0H	1 p	±0.05pF, ±0.1pF, ±0.25pF	300	200	200	0.2±0.02	
MSART042SCH1R1[WRA01]	TVS042 CH1R1[C-W]		CH	C0H	1.1 p	±0.05pF, ±0.1pF, ±0.25pF	280	200	200	0.2±0.02	
MSART042SCH1R2[WRA01]	TVS042 CH1R2[C-W]		CH	C0H	1.2 p	±0.05pF, ±0.1pF, ±0.25pF	270	200	200	0.2±0.02	
MSART042SCH1R3[WRA01]	TVS042 CH1R3[C-W]		CH	C0H	1.3 p	±0.05pF, ±0.1pF, ±0.25pF	260	200	200	0.2±0.02	
MSART042SCH1R4[WRA01]	TVS042 CH1R4[C-W]		CH	C0H	1.4 p	±0.05pF, ±0.1pF, ±0.25pF	250	200	200	0.2±0.02	
MSART042SCH1R5[WRA01]	TVS042 CH1R5[C-W]		CH	C0H	1.5 p	±0.05pF, ±0.1pF, ±0.25pF	240	200	200	0.2±0.02	
MSART042SCH1R6[WRA01]	TVS042 CH1R6[C-W]		CH	C0H	1.6 p	±0.05pF, ±0.1pF, ±0.25pF	230	200	200	0.2±0.02	
MSART042SCH1R7[WRA01]	TVS042 CH1R7[C-W]		CH	C0H	1.7 p	±0.05pF, ±0.1pF, ±0.25pF	220	200	200	0.2±0.02	
MSART042SCH1R8[WRA01]	TVS042 CH1R8[C-W]		CH	C0H	1.8 p	±0.05pF, ±0.1pF, ±0.25pF	210	200	200	0.2±0.02	
MSART042SCH1R9[WRA01]	TVS042 CH1R9[C-W]		CH	C0H	1.9 p	±0.05pF, ±0.1pF, ±0.25pF	200	200	200	0.2±0.02	
MSART042SCH020[WRA01]	TVS042 CH020[C-W]		CH	C0H	2 p	±0.05pF, ±0.1pF, ±0.25pF	190	200	200	0.2±0.02	
MSART042SCH2R1[WRA01]	TVS042 CH2R1[C-W]		CH	C0H	2.1 p	±0.05pF, ±0.1pF, ±0.25pF	185	200	200	0.2±0.02	
MSART042SCH2R2[WRA01]	TVS042 CH2R2[C-W]		CH	C0H	2.2 p	±0.05pF, ±0.1pF, ±0.25pF	180	200	200	0.2±0.02	
MSART042SCH2R3[WRA01]	TVS042 CH2R3[C-W]		CH	C0H	2.3 p	±0.05pF, ±0.1pF, ±0.25pF	175	200	200	0.2±0.02	
MSART042SCH2R4[WRA01]	TVS042 CH2R4[C-W]		CH	C0H	2.4 p	±0.05pF, ±0.1pF, ±0.25pF	170	200	200	0.2±0.02	
MSART042SCH2R5[WRA01]	TVS042 CH2R5[C-W]		CH	C0H	2.5 p	±0.05pF, ±0.1pF, ±0.25pF	160	200	200	0.2±0.02	
MSART042SCH2R6[WRA01]	TVS042 CH2R6[C-W]		CH	C0H	2.6 p	±0.05pF, ±0.1pF, ±0.25pF	155	200	200	0.2±0.02	
MSART042SCH2R7[WRA01]	TVS042 CH2R7[C-W]		CH	C0H	2.7 p	±0.05pF, ±0.1pF, ±0.25pF	150	200	200	0.2±0.02	
MSART042SCH2R8[WRA01]	TVS042 CH2R8[C-W]		CH	C0H	2.8 p	±0.05pF, ±0.1pF, ±0.25pF	140	200	200	0.2±0.02	
MSART042SCH2R9[WRA01]	TVS042 CH2R9[C-W]		CH	C0H	2.9 p	±0.05pF, ±0.1pF, ±0.25pF	135	200	200	0.2±0.02	
MSART042SCH030[WRA01]	TVS042 CH030[C-W]		CH	C0H	3 p	±0.05pF, ±0.1pF, ±0.25pF	130	200	200	0.2±0.02	
MSART042SCH3R1[WRA01]	TVS042 CH3R1[C-W]		CH	C0H	3.1 p	±0.1pF, ±0.25pF	125	200	200	0.2±0.02	
MSART042SCH3R2[WRA01]	TVS042 CH3R2[C-W]		CH	C0H	3.2 p	±0.1pF, ±0.25pF	125	200	200	0.2±0.02	
MSART042SCH3R3[WRA01]	TVS042 CH3R3[C-W]		CH	C0H	3.3 p	±0.1pF, ±0.25pF	120	200	200	0.2±0.02	
MSART042SCH3R4[WRA01]	TVS042 CH3R4[C-W]		CH	C0H	3.4 p	±0.1pF, ±0.25pF	120	200	200	0.2±0.02	
MSART042SCH3R5[WRA01]	TVS042 CH3R5[C-W]		CH	C0H	3.5 p	±0.1pF, ±0.25pF	110	200	200	0.2±0.02	
MSART042SCH3R6[WRA01]	TVS042 CH3R6[C-W]		CH	C0H	3.6 p	±0.1pF, ±0.25pF	110	200	200	0.2±0.02	
MSART042SCH3R7[WRA01]	TVS042 CH3R7[C-W]		CH	C0H	3.7 p	±0.1pF, ±0.25pF	110	200	200	0.2±0.02	
MSART042SCH3R8[WRA01]	TVS042 CH3R8[C-W]		CH	C0H	3.8 p	±0.1pF, ±0.25pF	100	200	200	0.2±0.02	
MSART042SCH3R9[WRA01]	TVS042 CH3R9[C-W]		CH	C0H	3.9 p	±0.1pF, ±0.25pF	100	200	200	0.2±0.02	
MSART042SCH040[WRA01]	TVS042 CH040[C-W]		CH	C0H	4 p	±0.1pF, ±0.25pF	90	200	200	0.2±0.02	
MSART042SCH4R1[WRA01]	TVS042 CH4R1[C-W]	CH	C0H	4.1 p	±0.1pF, ±0.25pF	90	200	200	0.2±0.02		
MSART042SCH4R2[WRA01]	TVS042 CH4R2[C-W]	CH	C0H	4.2 p	±0.1pF, ±0.25pF	85	200	200	0.2±0.02		
MSART042SCH4R3[WRA01]	TVS042 CH4R3[C-W]	CH	C0H	4.3 p	±0.1pF, ±0.25pF	85	200	200	0.2±0.02		
MSART042SCH4R4[WRA01]	TVS042 CH4R4[C-W]	CH	C0H	4.4 p	±0.1pF, ±0.25pF	85	200	200	0.2±0.02		
MSART042SCH4R5[WRA01]	TVS042 CH4R5[C-W]	CH	C0H	4.5 p	±0.1pF, ±0.25pF	85	200	200	0.2±0.02		
MSART042SCH4R6[WRA01]	TVS042 CH4R6[C-W]	CH	C0H	4.6 p	±0.1pF, ±0.25pF	85	200	200	0.2±0.02		
MSART042SCH4R7[WRA01]	TVS042 CH4R7[C-W]	CH	C0H	4.7 p	±0.1pF, ±0.25pF	85	200	200	0.2±0.02		
MSART042SCH4R8[WRA01]	TVS042 CH4R8[C-W]	CH	C0H	4.8 p	±0.1pF, ±0.25pF	80	200	200	0.2±0.02		
MSART042SCH4R9[WRA01]	TVS042 CH4R9[C-W]	CH	C0H	4.9 p	±0.1pF, ±0.25pF	80	200	200	0.2±0.02		
MSART042SCH050[WRA01]	TVS042 CH050[C-W]	CH	C0H	5 p	±0.1pF, ±0.25pF	80	200	200	0.2±0.02		
MSART042SCH5R1[WRA01]	TVS042 CH5R1[C-W]	CH	C0H	5.1 p	±0.1pF, ±0.25pF, ±0.5pF	75	200	200	0.2±0.02		
MSART042SCH5R2[WRA01]	TVS042 CH5R2[C-W]	CH	C0H	5.2 p	±0.1pF, ±0.25pF, ±0.5pF	75	200	200	0.2±0.02		
MSART042SCH5R3[WRA01]	TVS042 CH5R3[C-W]	CH	C0H	5.3 p	±0.1pF, ±0.25pF, ±0.5pF	75	200	200	0.2±0.02		
MSART042SCH5R4[WRA01]	TVS042 CH5R4[C-W]	CH	C0H	5.4 p	±0.1pF, ±0.25pF, ±0.5pF	70	200	200	0.2±0.02		
MSART042SCH5R5[WRA01]	TVS042 CH5R5[C-W]	CH	C0H	5.5 p	±0.1pF, ±0.25pF, ±0.5pF	70	200	200	0.2±0.02		
MSART042SCH5R6[WRA01]	TVS042 CH5R6[C-W]	CH	C0H	5.6 p	±0.1pF, ±0.25pF, ±0.5pF	70	200	200	0.2±0.02		
MSART042SCH5R7[WRA01]	TVS042 CH5R7[C-W]	CH	C0H	5.7 p	±0.1pF, ±0.25pF, ±0.5pF	70	200	200	0.2±0.02		
MSART042SCH5R8[WRA01]	TVS042 CH5R8[C-W]	CH	C0H	5.8 p	±0.1pF, ±0.25pF, ±0.5pF	70	200	200	0.2±0.02		
MSART042SCH5R9[WRA01]	TVS042 CH5R9[C-W]	CH	C0H	5.9 p	±0.1pF, ±0.25pF, ±0.5pF	65	200	200	0.2±0.02		
MSART042SCH060[WRA01]	TVS042 CH060[C-W]	CH	C0H	6 p	±0.1pF, ±0.25pF, ±0.5pF	65	200	200	0.2±0.02		
MSART042SCH6R1[WRA01]	TVS042 CH6R1[C-W]	CH	C0H	6.1 p	±0.1pF, ±0.25pF, ±0.5pF	65	200	200	0.2±0.02		
MSART042SCH6R2[WRA01]	TVS042 CH6R2[C-W]	CH	C0H	6.2 p	±0.1pF, ±0.25pF, ±0.5pF	65	200	200	0.2±0.02		
MSART042SCH6R3[WRA01]	TVS042 CH6R3[C-W]	CH	C0H	6.3 p	±0.1pF, ±0.25pF, ±0.5pF	65	200	200	0.2±0.02		
MSART042SCH6R4[WRA01]	TVS042 CH6R4[C-W]	CH	C0H	6.4 p	±0.1pF, ±0.25pF, ±0.5pF	65	200	200	0.2±0.02		
MSART042SCH6R5[WRA01]	TVS042 CH6R5[C-W]	CH	C0H	6.5 p	±0.1pF, ±0.25pF, ±0.5pF	65	200	200	0.2±0.02		
MSART042SCH6R6[WRA01]	TVS042 CH6R6[C-W]	CH	C0H	6.6 p	±0.1pF, ±0.25pF, ±0.5pF	60	200	200	0.2±0.02		
MSART042SCH6R7[WRA01]	TVS042 CH6R7[C-W]	CH	C0H	6.7 p	±0.1pF, ±0.25pF, ±0.5pF	60	200	200	0.2±0.02		
MSART042SCH6R8[WRA01]	TVS042 CH6R8[C-W]	CH	C0H	6.8 p	±0.1pF, ±0.25pF, ±0.5pF	60	200	200	0.2±0.02		
MSART042SCH6R9[WRA01]	TVS042 CH6R9[C-W]	CH	C0H	6.9 p	±0.1pF, ±0.25pF, ±0.5pF	60	200	200	0.2±0.02		
MSART042SCH070[WRA01]	TVS042 CH070[C-W]	CH	C0H	7 p	±0.1pF, ±0.25pF, ±0.5pF	60	200	200	0.2±0.02		
MSART042SCH7R1[WRA01]	TVS042 CH7R1[C-W]	CH	C0H	7.1 p	±0.1pF, ±0.25pF, ±0.5pF	60	200	200	0.2±0.02		
MSART042SCH7R2[WRA01]	TVS042 CH7R2[C-W]	CH	C0H	7.2 p	±0.1pF, ±0.25pF, ±0.5pF	60	200	200	0.2±0.02		
MSART042SCH7R3[WRA01]	TVS042 CH7R3[C-W]	CH	C0H	7.3 p	±0.1pF, ±0.25pF, ±0.5pF	55	200	200	0.2±0.02		
MSART042SCH7R4[WRA01]	TVS042 CH7R4[C-W]	CH	C0H	7.4 p	±0.1pF, ±0.25pF, ±0.5pF	55	200	200	0.2±0.02		
MSART042SCH7R5[WRA01]	TVS042 CH7R5[C-W]	CH	C0H	7.5 p	±0.1pF, ±0.25pF, ±0.5pF	55	200	200	0.2±0.02		
MSART042SCH7R6[WRA01]	TVS042 CH7R6[C-W]	CH	C0H	7.6 p	±0.1pF, ±0.25pF, ±0.5pF	55	200	200	0.2±0.02		
MSART042SCH7R7[WRA01]	TVS042 CH7R7[C-W]	CH	C0H	7.7 p	±0.1pF, ±0.25pF, ±0.5pF	55	200	200	0.2±0.02		
MSART042SCH7R8[WRA01]	TVS042 CH7R8[C-W]	CH	C0H	7.8 p	±0.1pF, ±0.25pF, ±0.5pF	55	200	200	0.2±0.02		
MSART042SCH7R9[WRA01]	TVS042 CH7R9[C-W]	CH	C0H	7.9 p	±0.1pF, ±0.25pF, ±0.5pF	55	200	200	0.2±0.02		
MSART042SCH080[WRA01]	TVS042 CH080[C-W]	CH	C0H	8 p	±0.1pF, ±0.25pF, ±0.5pF	55	200	200	0.2±0.02		
MSART042SCH8R1[WRA01]	TVS042 CH8R1[C-W]	CH	C0H	8.1 p	±0.1pF, ±0.25pF, ±0.5pF	55	200	200	0.2±0.02		
MSART042SCH8R2[WRA01]	TVS042 CH8R2[C-W]	CH	C0H	8.2 p	±0.1pF, ±0.25pF, ±0.5pF	50	200	200	0.2±0.02		
MSART042SCH8R3[WRA01]	TVS042 CH8R3[C-W]	CH	C0H	8.3 p	±0.1pF, ±0.25pF, ±0.5pF	50	200	200	0.2±0.02		
MSART042SCH8R4[WRA01]	TVS042 CH8R4[C-W]	CH	C0H	8.4 p	±0.1pF, ±0.25pF, ±0.5pF	50	200	200	0.2±0.02		

▶ This catalog contains the typical specification only due to the limitation of space. When you consider the purchase of our products, please check our specification. For details of each product (characteristics graph, reliability information, precautions for use, and so on), see our Web site (<http://www.ty-top.com/>).

PART NUMBER

New part number	Old part number (for reference)	Rated voltage [V]	Temperature characteristics		Capacitance [F]	Capacitance tolerance	Q (at 1GHz) (min)	HTLT	Thickness ^{*3} [mm]	Note
								Rated voltage x %		
MSART042SCH8R5□WRA01	TVS042 CH8R5□C-W	25	CH	C0H	8.5 p	±0.1pF, ±0.25pF, ±0.5pF	50	200	0.2±0.02	
MSART042SCH8R6□WRA01	TVS042 CH8R6□C-W		CH	C0H	8.6 p	±0.1pF, ±0.25pF, ±0.5pF	50	200	0.2±0.02	
MSART042SCH8R7□WRA01	TVS042 CH8R7□C-W		CH	C0H	8.7 p	±0.1pF, ±0.25pF, ±0.5pF	50	200	0.2±0.02	
MSART042SCH8R8□WRA01	TVS042 CH8R8□C-W		CH	C0H	8.8 p	±0.1pF, ±0.25pF, ±0.5pF	50	200	0.2±0.02	
MSART042SCH8R9□WRA01	TVS042 CH8R9□C-W		CH	C0H	8.9 p	±0.1pF, ±0.25pF, ±0.5pF	50	200	0.2±0.02	
MSART042SCH090□WRA01	TVS042 CH090□C-W		CH	C0H	9 p	±0.1pF, ±0.25pF, ±0.5pF	50	200	0.2±0.02	
MSART042SCH9R1□WRA01	TVS042 CH9R1□C-W		CH	C0H	9.1 p	±0.1pF, ±0.25pF, ±0.5pF	45	200	0.2±0.02	
MSART042SCH9R2□WRA01	TVS042 CH9R2□C-W		CH	C0H	9.2 p	±0.1pF, ±0.25pF, ±0.5pF	45	200	0.2±0.02	
MSART042SCH9R3□WRA01	TVS042 CH9R3□C-W		CH	C0H	9.3 p	±0.1pF, ±0.25pF, ±0.5pF	45	200	0.2±0.02	
MSART042SCH9R4□WRA01	TVS042 CH9R4□C-W		CH	C0H	9.4 p	±0.1pF, ±0.25pF, ±0.5pF	45	200	0.2±0.02	
MSART042SCH9R5□WRA01	TVS042 CH9R5□C-W		CH	C0H	9.5 p	±0.1pF, ±0.25pF, ±0.5pF	45	200	0.2±0.02	
MSART042SCH9R6□WRA01	TVS042 CH9R6□C-W		CH	C0H	9.6 p	±0.1pF, ±0.25pF, ±0.5pF	45	200	0.2±0.02	
MSART042SCH9R7□WRA01	TVS042 CH9R7□C-W		CH	C0H	9.7 p	±0.1pF, ±0.25pF, ±0.5pF	45	200	0.2±0.02	
MSART042SCH9R8□WRA01	TVS042 CH9R8□C-W		CH	C0H	9.8 p	±0.1pF, ±0.25pF, ±0.5pF	45	200	0.2±0.02	
MSART042SCH9R9□WRA01	TVS042 CH9R9□C-W		CH	C0H	9.9 p	±0.1pF, ±0.25pF, ±0.5pF	45	200	0.2±0.02	
MSART042SCH100□WRA01	TVS042 CH100□C-W		CH	C0H	10 p	±2%, ±5%	45	200	0.2±0.02	
MSART042SCH110JWRA01	TVS042 CH110JC-W		CH	C0H	11 p	±5%	40	200	0.2±0.02	
MSART042SCH120JWRA01	TVS042 CH120JC-W		CH	C0H	12 p	±5%	40	200	0.2±0.02	
MSART042SCH130JWRA01	TVS042 CH130JC-W		CH	C0H	13 p	±5%	40	200	0.2±0.02	
MSART042SCH150JWRA01	TVS042 CH150JC-W		CH	C0H	15 p	±5%	40	200	0.2±0.02	
MSART042SCH160JWRA01	TVS042 CH160JC-W		CH	C0H	16 p	±5%	40	200	0.2±0.02	
MSART042SCH180JWRA01	TVS042 CH180JC-W		CH	C0H	18 p	±5%	40	200	0.2±0.02	
MSART042SCH220JWRA01	TVS042 CH220JC-W		CH	C0H	22 p	±5%	30	200	0.2±0.02	

► This catalog contains the typical specification only due to the limitation of space. When you consider the purchase of our products, please check our specification.
For details of each product (characteristics graph, reliability information, precautions for use, and so on), see our Web site (<http://www.ty-top.com/>).

■ PART NUMBER

New part number	Old part number (for reference)	Rated voltage [V]	Temperature characteristics	Capacitance [F]	Capacitance tolerance	Q (at 1GHz) (min)	HTLT	Thickness ^{※3} [mm]	Note
							Rated voltage x %		
MSART042SCG0R2[W]RA01	TVS042 CG0R2[C-W]	25	CG C0G	0.2 p	±0.05pF, ±0.1pF, ±0.25pF	300	200	0.2±0.02	
MSART042SCG0R3[W]RA01	TVS042 CG0R3[C-W]		CG C0G	0.3 p	±0.05pF, ±0.1pF, ±0.25pF	300	200	0.2±0.02	
MSART042SCG0R4[W]RA01	TVS042 CG0R4[C-W]		CG C0G	0.4 p	±0.05pF, ±0.1pF, ±0.25pF	300	200	0.2±0.02	
MSART042SCG0R5[W]RA01	TVS042 CG0R5[C-W]		CG C0G	0.5 p	±0.05pF, ±0.1pF, ±0.25pF	300	200	0.2±0.02	
MSART042SCG0R6[W]RA01	TVS042 CG0R6[C-W]		CG C0G	0.6 p	±0.05pF, ±0.1pF, ±0.25pF	300	200	0.2±0.02	
MSART042SCG0R7[W]RA01	TVS042 CG0R7[C-W]		CG C0G	0.7 p	±0.05pF, ±0.1pF, ±0.25pF	300	200	0.2±0.02	
MSART042SCGR75[W]RA01	TVS042 CGR75[C-W]		CG C0G	0.75 p	±0.05pF, ±0.1pF, ±0.25pF	300	200	0.2±0.02	
MSART042SCG0R8[W]RA01	TVS042 CG0R8[C-W]		CG C0G	0.8 p	±0.05pF, ±0.1pF, ±0.25pF	300	200	0.2±0.02	
MSART042SCG0R9[W]RA01	TVS042 CG0R9[C-W]		CG C0G	0.9 p	±0.05pF, ±0.1pF, ±0.25pF	300	200	0.2±0.02	
MSART042SCG010[W]RA01	TVS042 CG010[C-W]		CG C0G	1 p	±0.05pF, ±0.1pF, ±0.25pF	300	200	0.2±0.02	
MSART042SCG1R1[W]RA01	TVS042 CG1R1[C-W]		CG C0G	1.1 p	±0.05pF, ±0.1pF, ±0.25pF	280	200	0.2±0.02	
MSART042SCG1R2[W]RA01	TVS042 CG1R2[C-W]		CG C0G	1.2 p	±0.05pF, ±0.1pF, ±0.25pF	270	200	0.2±0.02	
MSART042SCG1R3[W]RA01	TVS042 CG1R3[C-W]		CG C0G	1.3 p	±0.05pF, ±0.1pF, ±0.25pF	260	200	0.2±0.02	
MSART042SCG1R4[W]RA01	TVS042 CG1R4[C-W]		CG C0G	1.4 p	±0.05pF, ±0.1pF, ±0.25pF	250	200	0.2±0.02	
MSART042SCG1R5[W]RA01	TVS042 CG1R5[C-W]		CG C0G	1.5 p	±0.05pF, ±0.1pF, ±0.25pF	240	200	0.2±0.02	
MSART042SCG1R6[W]RA01	TVS042 CG1R6[C-W]		CG C0G	1.6 p	±0.05pF, ±0.1pF, ±0.25pF	230	200	0.2±0.02	
MSART042SCG1R7[W]RA01	TVS042 CG1R7[C-W]		CG C0G	1.7 p	±0.05pF, ±0.1pF, ±0.25pF	220	200	0.2±0.02	
MSART042SCG1R8[W]RA01	TVS042 CG1R8[C-W]		CG C0G	1.8 p	±0.05pF, ±0.1pF, ±0.25pF	210	200	0.2±0.02	
MSART042SCG1R9[W]RA01	TVS042 CG1R9[C-W]		CG C0G	1.9 p	±0.05pF, ±0.1pF, ±0.25pF	200	200	0.2±0.02	
MSART042SCG020[W]RA01	TVS042 CG020[C-W]		CG C0G	2 p	±0.05pF, ±0.1pF, ±0.25pF	190	200	0.2±0.02	
MSART042SCG2R1[W]RA01	TVS042 CG2R1[C-W]		CG C0G	2.1 p	±0.05pF, ±0.1pF, ±0.25pF	185	200	0.2±0.02	
MSART042SCG2R2[W]RA01	TVS042 CG2R2[C-W]		CG C0G	2.2 p	±0.05pF, ±0.1pF, ±0.25pF	180	200	0.2±0.02	
MSART042SCG2R3[W]RA01	TVS042 CG2R3[C-W]		CG C0G	2.3 p	±0.05pF, ±0.1pF, ±0.25pF	175	200	0.2±0.02	
MSART042SCG2R4[W]RA01	TVS042 CG2R4[C-W]		CG C0G	2.4 p	±0.05pF, ±0.1pF, ±0.25pF	170	200	0.2±0.02	
MSART042SCG2R5[W]RA01	TVS042 CG2R5[C-W]		CG C0G	2.5 p	±0.05pF, ±0.1pF, ±0.25pF	160	200	0.2±0.02	
MSART042SCG2R6[W]RA01	TVS042 CG2R6[C-W]		CG C0G	2.6 p	±0.05pF, ±0.1pF, ±0.25pF	155	200	0.2±0.02	
MSART042SCG2R7[W]RA01	TVS042 CG2R7[C-W]		CG C0G	2.7 p	±0.05pF, ±0.1pF, ±0.25pF	150	200	0.2±0.02	
MSART042SCG2R8[W]RA01	TVS042 CG2R8[C-W]		CG C0G	2.8 p	±0.05pF, ±0.1pF, ±0.25pF	140	200	0.2±0.02	
MSART042SCG2R9[W]RA01	TVS042 CG2R9[C-W]		CG C0G	2.9 p	±0.05pF, ±0.1pF, ±0.25pF	135	200	0.2±0.02	
MSART042SCG030[W]RA01	TVS042 CG030[C-W]		CG C0G	3 p	±0.05pF, ±0.1pF, ±0.25pF	130	200	0.2±0.02	
MSART042SCG3R1[W]RA01	TVS042 CG3R1[C-W]		CG C0G	3.1 p	±0.1pF, ±0.25pF	125	200	0.2±0.02	
MSART042SCG3R2[W]RA01	TVS042 CG3R2[C-W]		CG C0G	3.2 p	±0.1pF, ±0.25pF	125	200	0.2±0.02	
MSART042SCG3R3[W]RA01	TVS042 CG3R3[C-W]		CG C0G	3.3 p	±0.1pF, ±0.25pF	120	200	0.2±0.02	
MSART042SCG3R4[W]RA01	TVS042 CG3R4[C-W]		CG C0G	3.4 p	±0.1pF, ±0.25pF	120	200	0.2±0.02	
MSART042SCG3R5[W]RA01	TVS042 CG3R5[C-W]		CG C0G	3.5 p	±0.1pF, ±0.25pF	110	200	0.2±0.02	
MSART042SCG3R6[W]RA01	TVS042 CG3R6[C-W]		CG C0G	3.6 p	±0.1pF, ±0.25pF	110	200	0.2±0.02	
MSART042SCG3R7[W]RA01	TVS042 CG3R7[C-W]		CG C0G	3.7 p	±0.1pF, ±0.25pF	110	200	0.2±0.02	
MSART042SCG3R8[W]RA01	TVS042 CG3R8[C-W]		CG C0G	3.8 p	±0.1pF, ±0.25pF	100	200	0.2±0.02	
MSART042SCG3R9[W]RA01	TVS042 CG3R9[C-W]		CG C0G	3.9 p	±0.1pF, ±0.25pF	100	200	0.2±0.02	
MSART042SCG040[W]RA01	TVS042 CG040[C-W]		CG C0G	4 p	±0.1pF, ±0.25pF	90	200	0.2±0.02	
MSART042SCG4R1[W]RA01	TVS042 CG4R1[C-W]	CG C0G	4.1 p	±0.1pF, ±0.25pF	90	200	0.2±0.02		
MSART042SCG4R2[W]RA01	TVS042 CG4R2[C-W]	CG C0G	4.2 p	±0.1pF, ±0.25pF	85	200	0.2±0.02		
MSART042SCG4R3[W]RA01	TVS042 CG4R3[C-W]	CG C0G	4.3 p	±0.1pF, ±0.25pF	85	200	0.2±0.02		
MSART042SCG4R4[W]RA01	TVS042 CG4R4[C-W]	CG C0G	4.4 p	±0.1pF, ±0.25pF	85	200	0.2±0.02		
MSART042SCG4R5[W]RA01	TVS042 CG4R5[C-W]	CG C0G	4.5 p	±0.1pF, ±0.25pF	85	200	0.2±0.02		
MSART042SCG4R6[W]RA01	TVS042 CG4R6[C-W]	CG C0G	4.6 p	±0.1pF, ±0.25pF	85	200	0.2±0.02		
MSART042SCG4R7[W]RA01	TVS042 CG4R7[C-W]	CG C0G	4.7 p	±0.1pF, ±0.25pF	85	200	0.2±0.02		
MSART042SCG4R8[W]RA01	TVS042 CG4R8[C-W]	CG C0G	4.8 p	±0.1pF, ±0.25pF	80	200	0.2±0.02		
MSART042SCG4R9[W]RA01	TVS042 CG4R9[C-W]	CG C0G	4.9 p	±0.1pF, ±0.25pF	80	200	0.2±0.02		
MSART042SCG050[W]RA01	TVS042 CG050[C-W]	CG C0G	5 p	±0.1pF, ±0.25pF	80	200	0.2±0.02		
MSART042SCG5R1[W]RA01	TVS042 CG5R1[C-W]	CG C0G	5.1 p	±0.1pF, ±0.25pF, ±0.5pF	75	200	0.2±0.02		
MSART042SCG5R2[W]RA01	TVS042 CG5R2[C-W]	CG C0G	5.2 p	±0.1pF, ±0.25pF, ±0.5pF	75	200	0.2±0.02		
MSART042SCG5R3[W]RA01	TVS042 CG5R3[C-W]	CG C0G	5.3 p	±0.1pF, ±0.25pF, ±0.5pF	75	200	0.2±0.02		
MSART042SCG5R4[W]RA01	TVS042 CG5R4[C-W]	CG C0G	5.4 p	±0.1pF, ±0.25pF, ±0.5pF	70	200	0.2±0.02		
MSART042SCG5R5[W]RA01	TVS042 CG5R5[C-W]	CG C0G	5.5 p	±0.1pF, ±0.25pF, ±0.5pF	70	200	0.2±0.02		
MSART042SCG5R6[W]RA01	TVS042 CG5R6[C-W]	CG C0G	5.6 p	±0.1pF, ±0.25pF, ±0.5pF	70	200	0.2±0.02		
MSART042SCG5R7[W]RA01	TVS042 CG5R7[C-W]	CG C0G	5.7 p	±0.1pF, ±0.25pF, ±0.5pF	70	200	0.2±0.02		
MSART042SCG5R8[W]RA01	TVS042 CG5R8[C-W]	CG C0G	5.8 p	±0.1pF, ±0.25pF, ±0.5pF	70	200	0.2±0.02		
MSART042SCG5R9[W]RA01	TVS042 CG5R9[C-W]	CG C0G	5.9 p	±0.1pF, ±0.25pF, ±0.5pF	65	200	0.2±0.02		
MSART042SCG060[W]RA01	TVS042 CG060[C-W]	CG C0G	6 p	±0.1pF, ±0.25pF, ±0.5pF	65	200	0.2±0.02		
MSART042SCG6R1[W]RA01	TVS042 CG6R1[C-W]	CG C0G	6.1 p	±0.1pF, ±0.25pF, ±0.5pF	65	200	0.2±0.02		
MSART042SCG6R2[W]RA01	TVS042 CG6R2[C-W]	CG C0G	6.2 p	±0.1pF, ±0.25pF, ±0.5pF	65	200	0.2±0.02		
MSART042SCG6R3[W]RA01	TVS042 CG6R3[C-W]	CG C0G	6.3 p	±0.1pF, ±0.25pF, ±0.5pF	65	200	0.2±0.02		
MSART042SCG6R4[W]RA01	TVS042 CG6R4[C-W]	CG C0G	6.4 p	±0.1pF, ±0.25pF, ±0.5pF	65	200	0.2±0.02		
MSART042SCG6R5[W]RA01	TVS042 CG6R5[C-W]	CG C0G	6.5 p	±0.1pF, ±0.25pF, ±0.5pF	65	200	0.2±0.02		
MSART042SCG6R6[W]RA01	TVS042 CG6R6[C-W]	CG C0G	6.6 p	±0.1pF, ±0.25pF, ±0.5pF	60	200	0.2±0.02		
MSART042SCG6R7[W]RA01	TVS042 CG6R7[C-W]	CG C0G	6.7 p	±0.1pF, ±0.25pF, ±0.5pF	60	200	0.2±0.02		
MSART042SCG6R8[W]RA01	TVS042 CG6R8[C-W]	CG C0G	6.8 p	±0.1pF, ±0.25pF, ±0.5pF	60	200	0.2±0.02		
MSART042SCG6R9[W]RA01	TVS042 CG6R9[C-W]	CG C0G	6.9 p	±0.1pF, ±0.25pF, ±0.5pF	60	200	0.2±0.02		
MSART042SCG070[W]RA01	TVS042 CG070[C-W]	CG C0G	7 p	±0.1pF, ±0.25pF, ±0.5pF	60	200	0.2±0.02		
MSART042SCG7R1[W]RA01	TVS042 CG7R1[C-W]	CG C0G	7.1 p	±0.1pF, ±0.25pF, ±0.5pF	60	200	0.2±0.02		
MSART042SCG7R2[W]RA01	TVS042 CG7R2[C-W]	CG C0G	7.2 p	±0.1pF, ±0.25pF, ±0.5pF	60	200	0.2±0.02		
MSART042SCG7R3[W]RA01	TVS042 CG7R3[C-W]	CG C0G	7.3 p	±0.1pF, ±0.25pF, ±0.5pF	55	200	0.2±0.02		
MSART042SCG7R4[W]RA01	TVS042 CG7R4[C-W]	CG C0G	7.4 p	±0.1pF, ±0.25pF, ±0.5pF	55	200	0.2±0.02		
MSART042SCG7R5[W]RA01	TVS042 CG7R5[C-W]	CG C0G	7.5 p	±0.1pF, ±0.25pF, ±0.5pF	55	200	0.2±0.02		
MSART042SCG7R6[W]RA01	TVS042 CG7R6[C-W]	CG C0G	7.6 p	±0.1pF, ±0.25pF, ±0.5pF	55	200	0.2±0.02		
MSART042SCG7R7[W]RA01	TVS042 CG7R7[C-W]	CG C0G	7.7 p	±0.1pF, ±0.25pF, ±0.5pF	55	200	0.2±0.02		
MSART042SCG7R8[W]RA01	TVS042 CG7R8[C-W]	CG C0G	7.8 p	±0.1pF, ±0.25pF, ±0.5pF	55	200	0.2±0.02		
MSART042SCG7R9[W]RA01	TVS042 CG7R9[C-W]	CG C0G	7.9 p	±0.1pF, ±0.25pF, ±0.5pF	55	200	0.2±0.02		
MSART042SCG080[W]RA01	TVS042 CG080[C-W]	CG C0G	8 p	±0.1pF, ±0.25pF, ±0.5pF	55	200	0.2±0.02		
MSART042SCG8R1[W]RA01	TVS042 CG8R1[C-W]	CG C0G	8.1 p	±0.1pF, ±0.25pF, ±0.5pF	55	200	0.2±0.02		
MSART042SCG8R2[W]RA01	TVS042 CG8R2[C-W]	CG C0G	8.2 p	±0.1pF, ±0.25pF, ±0.5pF	50	200	0.2±0.02		
MSART042SCG8R3[W]RA01	TVS042 CG8R3[C-W]	CG C0G	8.3 p	±0.1pF, ±0.25pF, ±0.5pF	50	200	0.2±0.02		
MSART042SCG8R4[W]RA01	TVS042 CG8R4[C-W]	CG C0G	8.4 p	±0.1pF, ±0.25pF, ±0.5pF	50	200	0.2±0.02		
MSART042SCG8R5[W]RA01	TVS042 CG8R5[C-W]	CG C0G	8.5 p	±0.1pF, ±0.25pF, ±0.5pF	50	200	0.2±0.02		
MSART042SCG8R6[W]RA01	TVS042 CG8R6[C-W]	CG C0G	8.6 p	±0.1pF, ±0.25pF, ±0.5pF	50	200	0.2±0.02		
MSART042SCG8R7[W]RA01	TVS042 CG8R7[C-W]	CG C0G	8.7 p	±0.1pF, ±0.25pF, ±0.5pF	50	200	0.2±0.02		

▶ This catalog contains the typical specification only due to the limitation of space. When you consider the purchase of our products, please check our specification.
 For details of each product (characteristics graph, reliability information, precautions for use, and so on), see our Web site (<http://www.ty-top.com/>).

PART NUMBER

New part number	Old part number (for reference)	Rated voltage [V]	Temperature characteristics		Capacitance [F]	Capacitance tolerance	Q (at 1GHz) (min)	HTLT	Thickness ^{*3} [mm]	Note
								Rated voltage x %		
MSART042SCG8R8□WRA01	TVS042 CG8R8□C-W	25	CG	C0G	8.8 p	±0.1pF, ±0.25pF, ±0.5pF	50	200	0.2±0.02	
MSART042SCG8R9□WRA01	TVS042 CG8R9□C-W		CG	C0G	8.9 p	±0.1pF, ±0.25pF, ±0.5pF	50	200	0.2±0.02	
MSART042SCG090□WRA01	TVS042 CG090□C-W		CG	C0G	9 p	±0.1pF, ±0.25pF, ±0.5pF	50	200	0.2±0.02	
MSART042SCG9R1□WRA01	TVS042 CG9R1□C-W		CG	C0G	9.1 p	±0.1pF, ±0.25pF, ±0.5pF	45	200	0.2±0.02	
MSART042SCG9R2□WRA01	TVS042 CG9R2□C-W		CG	C0G	9.2 p	±0.1pF, ±0.25pF, ±0.5pF	45	200	0.2±0.02	
MSART042SCG9R3□WRA01	TVS042 CG9R3□C-W		CG	C0G	9.3 p	±0.1pF, ±0.25pF, ±0.5pF	45	200	0.2±0.02	
MSART042SCG9R4□WRA01	TVS042 CG9R4□C-W		CG	C0G	9.4 p	±0.1pF, ±0.25pF, ±0.5pF	45	200	0.2±0.02	
MSART042SCG9R5□WRA01	TVS042 CG9R5□C-W		CG	C0G	9.5 p	±0.1pF, ±0.25pF, ±0.5pF	45	200	0.2±0.02	
MSART042SCG9R6□WRA01	TVS042 CG9R6□C-W		CG	C0G	9.6 p	±0.1pF, ±0.25pF, ±0.5pF	45	200	0.2±0.02	
MSART042SCG9R7□WRA01	TVS042 CG9R7□C-W		CG	C0G	9.7 p	±0.1pF, ±0.25pF, ±0.5pF	45	200	0.2±0.02	
MSART042SCG9R8□WRA01	TVS042 CG9R8□C-W		CG	C0G	9.8 p	±0.1pF, ±0.25pF, ±0.5pF	45	200	0.2±0.02	
MSART042SCG9R9□WRA01	TVS042 CG9R9□C-W		CG	C0G	9.9 p	±0.1pF, ±0.25pF, ±0.5pF	45	200	0.2±0.02	
MSART042SCG100□WRA01	TVS042 CG100□C-W		CG	C0G	10 p	±2%, ±5%	45	200	0.2±0.02	
MSART042SCG110JWRA01	TVS042 CG110JC-W		CG	C0G	11 p	±5%	40	200	0.2±0.02	
MSART042SCG120JWRA01	TVS042 CG120JC-W		CG	C0G	12 p	±5%	40	200	0.2±0.02	
MSART042SCG130JWRA01	TVS042 CG130JC-W		CG	C0G	13 p	±5%	40	200	0.2±0.02	
MSART042SCG150JWRA01	TVS042 CG150JC-W		CG	C0G	15 p	±5%	40	200	0.2±0.02	
MSART042SCG160JWRA01	TVS042 CG160JC-W		CG	C0G	16 p	±5%	40	200	0.2±0.02	
MSART042SCG180JWRA01	TVS042 CG180JC-W		CG	C0G	18 p	±5%	40	200	0.2±0.02	
MSART042SCG220JWRA01	TVS042 CG220JC-W		CG	C0G	22 p	±5%	30	200	0.2±0.02	

► This catalog contains the typical specification only due to the limitation of space. When you consider the purchase of our products, please check our specification.
For details of each product (characteristics graph, reliability information, precautions for use, and so on), see our Web site (<http://www.ty-top.com/>).

PART NUMBER

Low distortion design/Audible/Good bias Multilayer Ceramic Capacitors (CFCAP) for General Electronic Equipment for Consumer

1005TYPE

[Temperature Characteristic SD : Standard(-55~+125°C)] 0.5mm thickness

New part number	Old part number (for reference)	Rated voltage [V]	Temperature characteristics	Capacitance [F]	Capacitance tolerance [%]	tan δ [%]	HTLT	Thickness ^{*3} [mm]	Note
							Rated voltage x %		
MSAYU105SSD391KFNA01	UMK105 SD391KV-F	50	Standard Type	390 p	±10	0.1	200	0.5±0.05	
MSAYU105SSD471KFNA01	UMK105 SD471KV-F		Standard Type	470 p	±10	0.1	200	0.5±0.05	
MSAYU105SSD561KFNA01	UMK105 SD561KV-F		Standard Type	560 p	±10	0.1	200	0.5±0.05	
MSAYT105SSD681KFNA01	TMK105 SD681KV-F	25	Standard Type	680 p	±10	0.1	200	0.5±0.05	
MSAYT105SSD821KFNA01	TMK105 SD821KV-F		Standard Type	820 p	±10	0.1	200	0.5±0.05	
MSAYT105SSD102KFNA01	TMK105 SD102KV-F		Standard Type	1000 p	±10	0.1	200	0.5±0.05	
MSAYT105SSD122KFNA01	TMK105 SD122KV-F	16	Standard Type	1200 p	±10	0.1	200	0.5±0.05	
MSAYE105SSD152KFNA01	EMK105 SD152KV-F		Standard Type	1500 p	±10	0.1	200	0.5±0.05	
MSAYE105SSD182KFNA01	EMK105 SD182KV-F		Standard Type	1800 p	±10	0.1	200	0.5±0.05	
MSAYE105SSD222KFNA01	EMK105 SD222KV-F	10	Standard Type	2200 p	±10	0.1	200	0.5±0.05	
MSAYE105SSD272KFNA01	EMK105 SD272KV-F		Standard Type	2700 p	±10	0.1	200	0.5±0.05	
MSAYL105SSD332KFNA01	LMK105 SD332KV-F		Standard Type	3300 p	±10	0.1	200	0.5±0.05	
MSAYL105SSD392KFNA01	LMK105 SD392KV-F	10	Standard Type	3900 p	±10	0.1	200	0.5±0.05	
MSAYL105SSD472KFNA01	LMK105 SD472KV-F		Standard Type	4700 p	±10	0.1	200	0.5±0.05	

[Temperature Characteristic SD : Standard(-55~+125°C)] 0.3mm thickness

New part number	Old part number (for reference)	Rated voltage [V]	Temperature characteristics	Capacitance [F]	Capacitance tolerance [%]	tan δ [%]	HTLT	Thickness ^{*3} [mm]	Note
							Rated voltage x %		
MSAYL1L3YSD152KFNA01	LMK105 SD152KP-F	10	Standard Type	1500 p	±10	0.1	200	0.3±0.03	
MSAYJ1L3YSD272KFNA01	JMK105 SD272KP-F	6.3	Standard Type	2700 p	±10	0.1	200	0.3±0.03	

1608TYPE

[Temperature Characteristic SD : Standard(-55~+125°C)] 0.8mm thickness

New part number	Old part number (for reference)	Rated voltage [V]	Temperature characteristics	Capacitance [F]	Capacitance tolerance [%]	tan δ [%]	HTLT	Thickness ^{*3} [mm]	Note
							Rated voltage x %		
MSAYU168SSD102KTNA01	UMK107 SD102KA-T	50	Standard Type	1000 p	±10	0.1	200	0.8±0.10	
MSAYU168SSD122KTNA01	UMK107 SD122KA-T		Standard Type	1200 p	±10	0.1	200	0.8±0.10	
MSAYU168SSD152KTNA01	UMK107 SD152KA-T		Standard Type	1500 p	±10	0.1	200	0.8±0.10	
MSAYU168SSD182KTNA01	UMK107 SD182KA-T		Standard Type	1800 p	±10	0.1	200	0.8±0.10	
MSAYU168SSD222KTNA01	UMK107 SD222KA-T		Standard Type	2200 p	±10	0.1	200	0.8±0.10	
MSAYU168SSD272KTNA01	UMK107 SD272KA-T		Standard Type	2700 p	±10	0.1	200	0.8±0.10	
MSAYU168SSD332KTNA01	UMK107 SD332KA-T	25	Standard Type	3300 p	±10	0.1	200	0.8±0.10	
MSAYT168SSD392KTNA01	TMK107 SD392KA-T		Standard Type	3900 p	±10	0.1	200	0.8±0.10	
MSAYT168SSD472KTNA01	TMK107 SD472KA-T		Standard Type	4700 p	±10	0.1	200	0.8±0.10	
MSAYE168SSD562KTNA01	EMK107 SD562KA-T	16	Standard Type	5600 p	±10	0.1	200	0.8±0.10	
MSAYE168SSD682KTNA01	EMK107 SD682KA-T		Standard Type	6800 p	±10	0.1	200	0.8±0.10	
MSAYE168SSD822KTNA01	EMK107 SD822KA-T		Standard Type	8200 p	±10	0.1	200	0.8±0.10	
MSAYE168SSD103KTNA01	EMK107 SD103KA-T	10	Standard Type	0.01 μ	±10	0.1	200	0.8±0.10	
MSAYL168SSD123KTNA01	LMK107 SD123KA-T		Standard Type	0.012 μ	±10	0.1	200	0.8±0.10	
MSAYL168SSD153KTNA01	LMK107 SD153KA-T		Standard Type	0.015 μ	±10	0.1	200	0.8±0.10	
MSAYL168SSD183KTNA01	LMK107 SD183KA-T		Standard Type	0.018 μ	±10	0.1	200	0.8±0.10	
MSAYL168SSD223KTNA01	LMK107 SD223KA-T		Standard Type	0.022 μ	±10	0.1	200	0.8±0.10	

2012TYPE

[Temperature Characteristic SD : Standard(-55~+125°C)] 1.25mm thickness

New part number	Old part number (for reference)	Rated voltage [V]	Temperature characteristics	Capacitance [F]	Capacitance tolerance [%]	tan δ [%]	HTLT	Thickness ^{*3} [mm]	Note
							Rated voltage x %		
MSAYG21GSSD183KTNA01	GMK212 SD183KG-T	35	Standard Type	0.018 μ	±10	0.1	200	1.25±0.10	
MSAYG21GSSD223KTNA01	GMK212 SD223KG-T		Standard Type	0.022 μ	±10	0.1	200	1.25±0.10	
MSAYG21GSSD273KTNA01	GMK212 SD273KG-T		Standard Type	0.027 μ	±10	0.1	200	1.25±0.10	
MSAYL21GSSD683KTNA01	LMK212 SD683KG-T	10	Standard Type	0.068 μ	±10	0.1	200	1.25±0.10	
MSAYL21GSSD823KTNA01	LMK212 SD823KG-T		Standard Type	0.082 μ	±10	0.1	200	1.25±0.10	
MSAYL21GSSD104KTNA01	LMK212 SD104KG-T		Standard Type	0.1 μ	±10	0.1	200	1.25±0.10	

[Temperature Characteristic SD : Standard(-55~+125°C)] 0.85mm thickness

New part number	Old part number (for reference)	Rated voltage [V]	Temperature characteristics	Capacitance [F]	Capacitance tolerance [%]	tan δ [%]	HTLT	Thickness ^{*3} [mm]	Note
							Rated voltage x %		
MSAYU219SSD392KTNA01	UMK212 SD392KD-T	50	Standard Type	3900 p	±10	0.1	200	0.85±0.10	
MSAYU219SSD472KTNA01	UMK212 SD472KD-T		Standard Type	4700 p	±10	0.1	200	0.85±0.10	
MSAYU219SSD562KTNA01	UMK212 SD562KD-T		Standard Type	5600 p	±10	0.1	200	0.85±0.10	
MSAYU219SSD682KTNA01	UMK212 SD682KD-T		Standard Type	6800 p	±10	0.1	200	0.85±0.10	
MSAYU219SSD822KTNA01	UMK212 SD822KD-T		Standard Type	8200 p	±10	0.1	200	0.85±0.10	
MSAYU219SSD103KTNA01	UMK212 SD103KD-T		Standard Type	0.01 μ	±10	0.1	200	0.85±0.10	
MSAYG219SSD123KTNA01	GMK212 SD123KD-T	35	Standard Type	0.012 μ	±10	0.1	200	0.85±0.10	
MSAYG219SSD153KTNA01	GMK212 SD153KD-T		Standard Type	0.015 μ	±10	0.1	200	0.85±0.10	
MSAYE219SSD333KTNA01	EMK212 SD333KD-T		Standard Type	0.033 μ	±10	0.1	200	0.85±0.10	
MSAYL219SSD473KTNA01	LMK212 SD473KD-T	10	Standard Type	0.047 μ	±10	0.1	200	0.85±0.10	

PART NUMBER

3216TYPE

【Temperature Characteristic SD : Standard(-55~+125°C)】 1.6mm thickness

New part number	Old part number (for reference)	Rated voltage [V]	Temperature characteristics	Capacitance [F]	Capacitance tolerance [%]	tan δ [%]	HTLT	Thickness*3 [mm]	Note
							Rated voltage x %		
MSAYT31LSSD823KTNA01	TMK316 SD823KL-T	25	Standard Type	0.082 μ	± 10	0.1	200	1.6 \pm 0.20	
MSAYT31LSSD104KTNA01	TMK316 SD104KL-T		Standard Type	0.1 μ	± 10	0.1	200	1.6 \pm 0.20	

【Temperature Characteristic SD : Standard(-55~+125°C)】 1.15mm thickness

New part number	Old part number (for reference)	Rated voltage [V]	Temperature characteristics	Capacitance [F]	Capacitance tolerance [%]	tan δ [%]	HTLT	Thickness*3 [mm]	Note
							Rated voltage x %		
MSAYG31QHSD333KTNA01	GMK316 SD333KF-T	35	Standard Type	0.033 μ	± 10	0.1	200	1.15 \pm 0.10	
MSAYG31QHSD393KTNA01	GMK316 SD393KF-T		Standard Type	0.039 μ	± 10	0.1	200	1.15 \pm 0.10	
MSAYT31QHSD473KTNA01	TMK316 SD473KF-T	25	Standard Type	0.047 μ	± 10	0.1	200	1.15 \pm 0.10	
MSAYT31QHSD563KTNA01	TMK316 SD563KF-T		Standard Type	0.056 μ	± 10	0.1	200	1.15 \pm 0.10	
MSAYT31QHSD683KTNA01	TMK316 SD683KF-T		Standard Type	0.068 μ	± 10	0.1	200	1.15 \pm 0.10	

PART NUMBER

Low distortion design/Audible/Good bias Multilayer Ceramic Capacitors (CF LD) for General Electronic Equipment for Consumer

● 1608TYPE

【Temperature Characteristic LD : X5R(-55~+85°C)】 0.8mm thickness

New part number	Old part number (for reference)	Rated voltage [V]	Temperature characteristics	Capacitance [F]	Capacitance tolerance [%]	tan δ [%]	HTLT	Thickness ^{*3} [mm]	Note
							Rated voltage x %		
MSAYU168BLD224□TNA01	UMK107BLD224□A-T	50	X5R	0.22 μ	±10, ±20	10	150	0.8+0.20/-0	
MSAYT168BLD474□TNA01	TMK107BLD474□A-T	25	X5R	0.47 μ	±10, ±20	10	150	0.8+0.20/-0	
MSAYT168BLD105□TNA01	TMK107BLD105□A-T		X5R	1 μ	±10, ±20	10	150	0.8+0.20/-0	

● 2012TYPE

【Temperature Characteristic LD : X5R(-55~+85°C)】 1.25mm thickness

New part number	Old part number (for reference)	Rated voltage [V]	Temperature characteristics	Capacitance [F]	Capacitance tolerance [%]	tan δ [%]	HTLT	Thickness ^{*3} [mm]	Note
							Rated voltage x %		
MSAYG21GSLD105□TNA01	GMK212 LD105□G-T	35	X5R	1 μ	±10, ±20	10	150	1.25±0.10	
MSAYG21GBLD225□TNA01	GMK212BLD225□G-T		X5R	2.2 μ	±10, ±20	10	150	1.25+0.20/-0	

● 3216TYPE

【Temperature Characteristic LD : X5R(-55~+85°C)】 1.6mm thickness

New part number	Old part number (for reference)	Rated voltage [V]	Temperature characteristics	Capacitance [F]	Capacitance tolerance [%]	tan δ [%]	HTLT	Thickness ^{*3} [mm]	Note
							Rated voltage x %		
MSAYU31LSLD105□TNA01	UMK316 LD105□L-T	50	X5R	1 μ	±10, ±20	10	150	1.6±0.20	
MSAYG31LBLD475□TNA01	GMK316BLD475□L-T	35	X5R	4.7 μ	±10, ±20	10	150	1.6±0.30	
MSAYT31LBLD106□TNA01	TMK316BLD106□L-T	25	X5R	10 μ	±10, ±20	10	150	1.6±0.30	

● 3225TYPE

【Temperature Characteristic LD : X5R(-55~+85°C)】 1.9mm thickness

New part number	Old part number (for reference)	Rated voltage [V]	Temperature characteristics	Capacitance [F]	Capacitance tolerance [%]	tan δ [%]	HTLT	Thickness ^{*3} [mm]	Note
							Rated voltage x %		
MSAYU32NSLD105□TNA01	UMK325 LD105□N-T	50	X5R	1 μ	±10, ±20	10	200	1.9±0.20	

【Temperature Characteristic LD : X5R(-55~+85°C)】 2.5mm thickness

New part number	Old part number (for reference)	Rated voltage [V]	Temperature characteristics	Capacitance [F]	Capacitance tolerance [%]	tan δ [%]	HTLT	Thickness ^{*3} [mm]	Note
							Rated voltage x %		
MSAYU32MSLD475□PNA01	UMK325 LD475□M-P	50	X5R	4.7 μ	±10, ±20	10	200	2.5±0.20	

* This catalog contains the typical specification only due to the limitation of space. When you consider the purchase of our products, please check our specification.
For details of each product (characteristics graph, reliability information, precautions for use, and so on), see our Web site (<http://www.ty-top.com/>).

PART NUMBER

Medium-High Voltage Multilayer Ceramic Capacitors for General Electronic Equipment for Consumer

1005TYPE

【Temperature Characteristic B7 : X7R(-55~+125°C)】 0.5mm thickness

New part number	Old part number (for reference)	Rated voltage [V]	Temperature characteristics		Capacitance [F]	Capacitance tolerance [%]	tan δ [%]	HTLT	Thickness*3 [mm]	Note
								Rated voltage x %		
MSASH105SB7221[FNA01	HMK105 B7221[V-F	100		X7R	220 p	±10, ±20	2.5	200	0.5±0.05	
MSASH105SB7331[FNA01	HMK105 B7331[V-F			X7R	330 p	±10, ±20	2.5	200	0.5±0.05	
MSASH105SB7471[FNA01	HMK105 B7471[V-F			X7R	470 p	±10, ±20	2.5	200	0.5±0.05	
MSASH105SB7681[FNA01	HMK105 B7681[V-F			X7R	680 p	±10, ±20	2.5	200	0.5±0.05	
MSASH105SB7102[FNA01	HMK105 B7102[V-F			X7R	1000 p	±10, ±20	2.5	200	0.5±0.05	
MSASH105SB7152[FNA01	HMK105 B7152[V-F			X7R	1500 p	±10, ±20	2.5	200	0.5±0.05	
MSASH105SB7222[FNA01	HMK105 B7222[V-F			X7R	2200 p	±10, ±20	2.5	200	0.5±0.05	
MSASH105SB7332[FNA01	HMK105 B7332[V-F			X7R	3300 p	±10, ±20	2.5	200	0.5±0.05	
MSASH105SB7472[FNA01	HMK105 B7472[V-F			X7R	4700 p	±10, ±20	2.5	200	0.5±0.05	

【Temperature Characteristic CΔ : CΔ/C0Δ(-55~+125°C)】 0.5mm thickness

New part number	Old part number (for reference)	Rated voltage [V]	Temperature characteristics		Capacitance [F]	Capacitance tolerance	Q (at 1MHz) (min)	HTLT	Thickness*3 [mm]	Note
								Rated voltage x %		
MSASH105SCH080DFNA01	HMK105 CH080DV-F	100	CH	C0H	8 p	±0.5pF	560	200	0.5±0.05	
MSASH105SCH090DFNA01	HMK105 CH090DV-F		CH	C0H	9 p	±0.5pF	580	200	0.5±0.05	
MSASH105SCH100DFNA01	HMK105 CH100DV-F		CH	C0H	10 p	±0.5pF	600	200	0.5±0.05	
MSASH105SCH120JFNA01	HMK105 CH120JV-F		CH	C0H	12 p	±5%	640	200	0.5±0.05	
MSASH105SCH150JFNA01	HMK105 CH150JV-F		CH	C0H	15 p	±5%	700	200	0.5±0.05	
MSASH105SCH180JFNA01	HMK105 CH180JV-F		CH	C0H	18 p	±5%	760	200	0.5±0.05	
MSASH105SCH220JFNA01	HMK105 CH220JV-F		CH	C0H	22 p	±5%	840	200	0.5±0.05	
MSASH105SCH240JFNA01	HMK105 CH240JV-F		CH	C0H	24 p	±5%	880	200	0.5±0.05	
MSASH105SCH270JFNA01	HMK105 CH270JV-F		CH	C0H	27 p	±5%	940	200	0.5±0.05	
MSASH105SCH330JFNA01	HMK105 CH330JV-F		CH	C0H	33 p	±5%	1000	200	0.5±0.05	
MSASH105SCH390JFNA01	HMK105 CH390JV-F		CH	C0H	39 p	±5%	1000	200	0.5±0.05	
MSASH105SCH470JFNA01	HMK105 CH470JV-F		CH	C0H	47 p	±5%	1000	200	0.5±0.05	
MSASH105SCH560JFNA01	HMK105 CH560JV-F		CH	C0H	56 p	±5%	1000	200	0.5±0.05	
MSASH105SCH680JFNA01	HMK105 CH680JV-F		CH	C0H	68 p	±5%	1000	200	0.5±0.05	
MSASH105SCH820JFNA01	HMK105 CH820JV-F		CH	C0H	82 p	±5%	1000	200	0.5±0.05	
MSASH105SCH101JFNA01	HMK105 CH101JV-F		CH	C0H	100 p	±5%	1000	200	0.5±0.05	
MSASH105SCG080DFNA01	HMK105 CG080DV-F		CG	C0G	8 p	±0.5pF	560	200	0.5±0.05	
MSASH105SCG090DFNA01	HMK105 CG090DV-F		CG	C0G	9 p	±0.5pF	580	200	0.5±0.05	
MSASH105SCG100DFNA01	HMK105 CG100DV-F		CG	C0G	10 p	±0.5pF	600	200	0.5±0.05	
MSASH105SCG120JFNA01	HMK105 CG120JV-F		CG	C0G	12 p	±5%	640	200	0.5±0.05	
MSASH105SCG150JFNA01	HMK105 CG150JV-F		CG	C0G	15 p	±5%	700	200	0.5±0.05	
MSASH105SCG180JFNA01	HMK105 CG180JV-F		CG	C0G	18 p	±5%	760	200	0.5±0.05	
MSASH105SCG220JFNA01	HMK105 CG220JV-F		CG	C0G	22 p	±5%	840	200	0.5±0.05	
MSASH105SCG240JFNA01	HMK105 CG240JV-F		CG	C0G	24 p	±5%	880	200	0.5±0.05	
MSASH105SCG270JFNA01	HMK105 CG270JV-F		CG	C0G	27 p	±5%	940	200	0.5±0.05	
MSASH105SCG330JFNA01	HMK105 CG330JV-F		CG	C0G	33 p	±5%	1000	200	0.5±0.05	
MSASH105SCG390JFNA01	HMK105 CG390JV-F		CG	C0G	39 p	±5%	1000	200	0.5±0.05	
MSASH105SCG470JFNA01	HMK105 CG470JV-F		CG	C0G	47 p	±5%	1000	200	0.5±0.05	
MSASH105SCG560JFNA01	HMK105 CG560JV-F		CG	C0G	56 p	±5%	1000	200	0.5±0.05	
MSASH105SCG680JFNA01	HMK105 CG680JV-F		CG	C0G	68 p	±5%	1000	200	0.5±0.05	
MSASH105SCG820JFNA01	HMK105 CG820JV-F		CG	C0G	82 p	±5%	1000	200	0.5±0.05	
MSASH105SCG101JFNA01	HMK105 CG101JV-F		CG	C0G	100 p	±5%	1000	200	0.5±0.05	

1608TYPE

【Temperature Characteristic B5(BJ) : B(-25~+85°C)/X5R(-55~+85°C)】 0.8mm thickness

New part number	Old part number (for reference)	Rated voltage [V]	Temperature characteristics		Capacitance [F]	Capacitance tolerance [%]	tan δ [%]	HTLT	Thickness*3 [mm]	Note
								Rated voltage x %		
MSASH168SB5102[TNA01	HMK107 BJ102[A-T	100	B	X5R*1	1000 p	±10, ±20	3.5	200	0.8±0.10	
MSASH168SB5152[TNA01	HMK107 BJ152[A-T		B	X5R*1	1500 p	±10, ±20	3.5	200	0.8±0.10	
MSASH168SB5222[TNA01	HMK107 BJ222[A-T		B	X5R*1	2200 p	±10, ±20	3.5	200	0.8±0.10	
MSASH168SB5332[TNA01	HMK107 BJ332[A-T		B	X5R*1	3300 p	±10, ±20	3.5	200	0.8±0.10	
MSASH168SB5472[TNA01	HMK107 BJ472[A-T		B	X5R*1	4700 p	±10, ±20	3.5	200	0.8±0.10	
MSASH168SB5682[TNA01	HMK107 BJ682[A-T		B	X5R*1	6800 p	±10, ±20	3.5	200	0.8±0.10	
MSASH168SB5103[TNA01	HMK107 BJ103[A-T		B	X5R*1	0.01 μ	±10, ±20	3.5	200	0.8±0.10	
MSASH168SB5153[TNA01	HMK107 BJ153[A-T		B	X5R*1	0.015 μ	±10, ±20	3.5	200	0.8±0.10	
MSASH168SB5223[TNA01	HMK107 BJ223[A-T		B	X5R*1	0.022 μ	±10, ±20	3.5	200	0.8±0.10	
MSASH168SB5333[TNA01	HMK107 BJ333[A-T		B	X5R*1	0.033 μ	±10, ±20	3.5	200	0.8±0.10	
MSASH168SB5473[TNA01	HMK107 BJ473[A-T		B	X5R*1	0.047 μ	±10, ±20	3.5	200	0.8±0.10	
MSASH168SB5104[TNA01	HMK107 BJ104[A-T		B	X5R*1	0.1 μ	±10, ±20	3.5	200	0.8±0.10	
MSASH168SB5224[TCA01	HMK107 BJ224[A-TE		B	X5R*1	0.22 μ	±10, ±20	3.5	150	0.8±0.10	

【Temperature Characteristic C7 : X7S(-55~+125°C)】 0.8mm thickness

New part number	Old part number (for reference)	Rated voltage [V]	Temperature characteristics		Capacitance [F]	Capacitance tolerance [%]	tan δ [%]	HTLT	Thickness*3 [mm]	Note
								Rated voltage x %		
MSASH168SC7224[TCA01	HMK107 C7224[A-TE	100		X7S	0.22 μ	±10, ±20	3.5	150	0.8±0.10	

▶ This catalog contains the typical specification only due to the limitation of space. When you consider the purchase of our products, please check our specification.
For details of each product (characteristics graph, reliability information, precautions for use, and so on), see our Web site (<http://www.ty-top.com/>).

PART NUMBER

【Temperature Characteristic B7 : X7R(-55~+125°C)】 0.8mm thickness

New part number	Old part number (for reference)	Rated voltage [V]	Temperature characteristics		Capacitance [F]	Capacitance tolerance [%]	tan δ [%]	HTLT	Thickness ^{*3} [mm]	Note
								Rated voltage x %		
MSASH168SB7102□TNA01	HMK107 B7102□A-T	100	X7R	1000 p	±10, ±20	3.5	200	0.8±0.10		
MSASH168SB7152□TNA01	HMK107 B7152□A-T									
MSASH168SB7222□TNA01	HMK107 B7222□A-T		X7R	2200 p	±10, ±20	3.5	200	0.8±0.10		
MSASH168SB7332□TNA01	HMK107 B7332□A-T									
MSASH168SB7472□TNA01	HMK107 B7472□A-T		X7R	4700 p	±10, ±20	3.5	200	0.8±0.10		
MSASH168SB7682□TNA01	HMK107 B7682□A-T									
MSASH168SB7103□TNA01	HMK107 B7103□A-T		X7R	0.01 μ	±10, ±20	3.5	200	0.8±0.10		
MSASH168SB7153□TNA01	HMK107 B7153□A-T									
MSASH168SB7223□TNA01	HMK107 B7223□A-T		X7R	0.022 μ	±10, ±20	3.5	200	0.8±0.10		
MSASH168SB7333□TNA01	HMK107 B7333□A-T									
MSASH168SB7473□TNA01	HMK107 B7473□A-T		X7R	0.033 μ	±10, ±20	3.5	200	0.8±0.10		
MSASH168SB7104□TNA01	HMK107 B7104□A-T									
MSASH168SB7104□TNA01	HMK107 B7104□A-T		X7R	0.047 μ	±10, ±20	3.5	200	0.8±0.10		
MSASH168SB7104□TNA01	HMK107 B7104□A-T									
MSASH168SB7104□TNA01	HMK107 B7104□A-T	X7R	0.1 μ	±10, ±20	3.5	200	0.8±0.10			
MSASH168SB7104□TNA01	HMK107 B7104□A-T									

【Temperature Characteristic SD : Standard(-55~+125°C)】 0.8mm thickness

New part number	Old part number (for reference)	Rated voltage [V]	Temperature characteristics		Capacitance [F]	Capacitance tolerance [%]	tan δ [%]	HTLT	Thickness ^{*3} [mm]	Note
								Rated voltage x %		
MSASH168SSD101KTNA01	HMK107 SD101KA-T	100	Standard Type	100 p	±10	0.1	200	0.8±0.10		
MSASH168SSD121KTNA01	HMK107 SD121KA-T									
MSASH168SSD151KTNA01	HMK107 SD151KA-T		Standard Type	150 p	±10	0.1	200	0.8±0.10		
MSASH168SSD181KTNA01	HMK107 SD181KA-T									
MSASH168SSD221KTNA01	HMK107 SD221KA-T		Standard Type	220 p	±10	0.1	200	0.8±0.10		
MSASH168SSD271KTNA01	HMK107 SD271KA-T									
MSASH168SSD331KTNA01	HMK107 SD331KA-T		Standard Type	330 p	±10	0.1	200	0.8±0.10		
MSASH168SSD391KTNA01	HMK107 SD391KA-T									
MSASH168SSD471KTNA01	HMK107 SD471KA-T		Standard Type	470 p	±10	0.1	200	0.8±0.10		
MSASH168SSD561KTNA01	HMK107 SD561KA-T									
MSASH168SSD681KTNA01	HMK107 SD681KA-T		Standard Type	680 p	±10	0.1	200	0.8±0.10		
MSASH168SSD821KTNA01	HMK107 SD821KA-T									
MSASH168SSD102KTNA01	HMK107 SD102KA-T		Standard Type	1000 p	±10	0.1	200	0.8±0.10		
MSASH168SSD102KTNA01	HMK107 SD102KA-T									

2012TYPE

【Temperature Characteristic B5(BJ) : B(-25~+85°C)/X5R(-55~+85°C)】 1.25mm thickness

New part number	Old part number (for reference)	Rated voltage [V]	Temperature characteristics		Capacitance [F]	Capacitance tolerance [%]	tan δ [%]	HTLT	Thickness ^{*3} [mm]	Note
								Rated voltage x %		
MSASH21GSB5103□TNA01	HMK212 BJ103□G-T	100	B	X5R ^{*1}	0.01 μ	±10, ±20	3.5	200	1.25±0.10	
MSASH21GSB5153□TNA01	HMK212 BJ153□G-T									
MSASH21GSB5223□TNA01	HMK212 BJ223□G-T		B	X5R ^{*1}	0.022 μ	±10, ±20	3.5	200	1.25±0.10	
MSASH21GSB5333□TNA01	HMK212 BJ333□G-T									
MSASH21GSB5473□TNA01	HMK212 BJ473□G-T		B	X5R ^{*1}	0.047 μ	±10, ±20	3.5	200	1.25±0.10	
MSASH21GSB5683□TNA01	HMK212 BJ683□G-T									
MSASH21GSB5104□TNA01	HMK212 BJ104□G-T		B	X5R ^{*1}	0.1 μ	±10, ±20	3.5	200	1.25±0.10	
MSASH21GSB5224□TNA01	HMK212 BJ224□G-T									
MSASH21GSB5474□TCA01	HMK212 BJ474□G-TE		B	X5R ^{*1}	0.47 μ	±10, ±20	3.5	150	1.25±0.10	
MSASH21GGB5105□TCA01	HMK212BBJ105□G-TE									
MSASQ21GSB5472□TNA01	QMK212 BJ472□G-T		B	X5R ^{*1}	4700 p	±10, ±20	2.5	150	1.25±0.10	
MSASQ21GSB5682□TNA01	QMK212 BJ682□G-T									
MSASQ21GSB5103□TNA01	QMK212 BJ103□G-T		B	X5R ^{*1}	0.01 μ	±10, ±20	2.5	150	1.25±0.10	
MSASQ21GSB5153□TNA01	QMK212 BJ153□G-T									
MSASQ21GSB5223□TNA01	QMK212 BJ223□G-T	B	X5R ^{*1}	0.022 μ	±10, ±20	2.5	150	1.25±0.10		
MSASQ21GSB5223□TNA01	QMK212 BJ223□G-T									

【Temperature Characteristic B5(BJ) : B(-25~+85°C)/X5R(-55~+85°C)】 0.85mm thickness

New part number	Old part number (for reference)	Rated voltage [V]	Temperature characteristics		Capacitance [F]	Capacitance tolerance [%]	tan δ [%]	HTLT	Thickness ^{*3} [mm]	Note
								Rated voltage x %		
MSASQ219SB5102□TNA01	QMK212 BJ102□D-T	250	B	X5R ^{*1}	1000 p	±10, ±20	2.5	150	0.85±0.10	
MSASQ219SB5152□TNA01	QMK212 BJ152□D-T									
MSASQ219SB5222□TNA01	QMK212 BJ222□D-T		B	X5R ^{*1}	2200 p	±10, ±20	2.5	150	0.85±0.10	
MSASQ219SB5332□TNA01	QMK212 BJ332□D-T									

【Temperature Characteristic C7 : X7S(-55~+125°C)】 1.25mm thickness

New part number	Old part number (for reference)	Rated voltage [V]	Temperature characteristics		Capacitance [F]	Capacitance tolerance [%]	tan δ [%]	HTLT	Thickness ^{*3} [mm]	Note
								Rated voltage x %		
MSASH21GSC7474□TCA01	HMK212 C7474□G-TE	100	X7S	0.47 μ	±10, ±20	3.5	150	1.25±0.10		
MSASH21GBC7105□TCA01	HMK212BC7105□G-TE									X7S

* This catalog contains the typical specification only due to the limitation of space. When you consider the purchase of our products, please check our specification.
For details of each product (characteristics graph, reliability information, precautions for use, and so on), see our Web site (<http://www.ty-top.com/>).

PART NUMBER

【Temperature Characteristic B7 : X7R(-55~+125°C)】 1.25mm thickness

New part number	Old part number (for reference)	Rated voltage [V]	Temperature characteristics		Capacitance [F]	Capacitance tolerance [%]	tan δ [%]	HTLT	Thickness ³ [mm]	Note
								Rated voltage x %		
MSASH21GSB7103□TNA01	HMK212 B7103□G-T	100	X7R	0.01 μ	±10, ±20	3.5	200	1.25±0.10		
MSASH21GSB7153□TNA01	HMK212 B7153□G-T									
MSASH21GSB7223□TNA01	HMK212 B7223□G-T		X7R	0.022 μ	±10, ±20	3.5	200	1.25±0.10		
MSASH21GSB7333□TNA01	HMK212 B7333□G-T									
MSASH21GSB7473□TNA01	HMK212 B7473□G-T		X7R	0.033 μ	±10, ±20	3.5	200	1.25±0.10		
MSASH21GSB7683□TNA01	HMK212 B7683□G-T									
MSASH21GSB7104□TNA01	HMK212 B7104□G-T		X7R	0.047 μ	±10, ±20	3.5	200	1.25±0.10		
MSASH21GSB7224□TNA01	HMK212 B7224□G-T									
MSASQ21GSB7472□TNA01	QMK212 B7472□G-T	250	X7R	0.068 μ	±10, ±20	3.5	200	1.25±0.10		
MSASQ21GSB7682□TNA01	QMK212 B7682□G-T									
MSASQ21GSB7103□TNA01	QMK212 B7103□G-T		X7R	0.1 μ	±10, ±20	2.5	150	1.25±0.10		
MSASQ21GSB7153□TNA01	QMK212 B7153□G-T									
MSASQ21GSB7223□TNA01	QMK212 B7223□G-T		X7R	0.022 μ	±10, ±20	2.5	150	1.25±0.10		

【Temperature Characteristic B7 : X7R(-55~+125°C)】 0.85mm thickness

New part number	Old part number (for reference)	Rated voltage [V]	Temperature characteristics		Capacitance [F]	Capacitance tolerance [%]	tan δ [%]	HTLT	Thickness ³ [mm]	Note
								Rated voltage x %		
MSASQ219SB7102□TNA01	QMK212 B7102□D-T	250	X7R	1000 p	±10, ±20	2.5	150	0.85±0.10		
MSASQ219SB7152□TNA01	QMK212 B7152□D-T									
MSASQ219SB7222□TNA01	QMK212 B7222□D-T		X7R	2200 p	±10, ±20	2.5	150	0.85±0.10		
MSASQ219SB7332□TNA01	QMK212 B7332□D-T									

【Temperature Characteristic SD : Standard(-55~+125°C)】 0.85mm thickness

New part number	Old part number (for reference)	Rated voltage [V]	Temperature characteristics		Capacitance [F]	Capacitance tolerance [%]	tan δ [%]	HTLT	Thickness ³ [mm]	Note
								Rated voltage x %		
MSASH219SSD222KTNA01	HMK212 SD222KD-T	100	Standard Type	2200 p	±10	0.1	200	0.85±0.10		
MSASH219SSD472KTNA01	HMK212 SD472KD-T									
MSASQ219SSD101KTNA01	QMK212 SD101KD-T		Standard Type	100 p	±10	0.1	150	0.85±0.10		
MSASQ219SSD121KTNA01	QMK212 SD121KD-T									
MSASQ219SSD151KTNA01	QMK212 SD151KD-T		Standard Type	120 p	±10	0.1	150	0.85±0.10		
MSASQ219SSD181KTNA01	QMK212 SD181KD-T									
MSASQ219SSD221KTNA01	QMK212 SD221KD-T		Standard Type	180 p	±10	0.1	150	0.85±0.10		
MSASQ219SSD331KTNA01	QMK212 SD331KD-T									
MSASQ219SSD391KTNA01	QMK212 SD391KD-T	250	Standard Type	390 p	±10	0.1	150	0.85±0.10		
MSASQ219SSD471KTNA01	QMK212 SD471KD-T									
MSASQ219SSD561KTNA01	QMK212 SD561KD-T		Standard Type	470 p	±10	0.1	150	0.85±0.10		
MSASQ219SSD681KTNA01	QMK212 SD681KD-T									
MSASQ219SSD821KTNA01	QMK212 SD821KD-T		Standard Type	680 p	±10	0.1	150	0.85±0.10		
MSASQ219SSD102KTNA01	QMK212 SD102KD-T									

【Temperature Characteristic SD : Standard(-55~+125°C)】 1.25mm thickness

New part number	Old part number (for reference)	Rated voltage [V]	Temperature characteristics		Capacitance [F]	Capacitance tolerance [%]	tan δ [%]	HTLT	Thickness ³ [mm]	Note
								Rated voltage x %		
MSASH21GSSD392KTNA01	HMK212 SD392KG-T	100	Standard Type	3900 p	±10	0.1	200	1.25±0.10		

3216TYPE

【Temperature Characteristic B5(BJ) : B(-25~+85°C)/X5R(-55~+85°C)】 1.6mm thickness

New part number	Old part number (for reference)	Rated voltage [V]	Temperature characteristics		Capacitance [F]	Capacitance tolerance [%]	tan δ [%]	HTLT	Thickness ³ [mm]	Note
								Rated voltage x %		
MSASH31LSB5473□TNA01	HMK316 BJ473□L-T	100	B	X5R ⁺	0.047 μ	±10, ±20	3.5	200	1.6±0.20	
MSASH31LSB5683□TNA01	HMK316 BJ683□L-T									
MSASH31LSB5104□TNA01	HMK316 BJ104□L-T		B	X5R ⁺	0.1 μ	±10, ±20	3.5	200	1.6±0.20	
MSASH31LSB5154□TNA01	HMK316 BJ154□L-T									
MSASH31LSB5224□TNA01	HMK316 BJ224□L-T		B	X5R ⁺	0.15 μ	±10, ±20	3.5	200	1.6±0.20	
MSASH31LSB5334□TNA01	HMK316 BJ334□L-T									
MSASH31LSB5474□TNA01	HMK316 BJ474□L-T		B	X5R ⁺	0.22 μ	±10, ±20	3.5	200	1.6±0.20	
MSASH31LSB5105□TNA01	HMK316 BJ105□L-T									
MSASH31LAB5225□TCA01	HMK316ABJ225□L-TE	B	X5R ⁺	0.33 μ	±10, ±20	3.5	200	1.6±0.20		
MSASQ31LSB5333□TNA01	QMK316 BJ333□L-T									
MSASQ31LSB5473□TNA01	QMK316 BJ473□L-T	B	X5R ⁺	0.47 μ	±10, ±20	3.5	200	1.6±0.20		
MSASQ31LSB5683□TNA01	QMK316 BJ683□L-T									
MSASQ31LSB5104□TNA01	QMK316 BJ104□L-T	B	X5R ⁺	0.7 μ	±10, ±20	2.5	150	1.6±0.20		
MSASQ31LSB5533□TNA01	QMK316 BJ533□L-T									
MSASQ31LSB5682□TNA01	QMK316 BJ682□L-T	B	X5R ⁺	0.088 μ	±10, ±20	2.5	150	1.6±0.20		
MSASQ31LSB5103□TNA01	QMK316 BJ103□L-T									
MSASS31LSB5153□TNA01	SMK316 BJ153□L-T	630	B	X5R ⁺	0.015 μ	±10, ±20	2.5	120	1.6±0.20	
MSASS31LSB5223□TNA01	SMK316 BJ223□L-T									

【Temperature Characteristic B5(BJ) : B(-25~+85°C)/X5R(-55~+85°C)】 1.15mm thickness

New part number	Old part number (for reference)	Rated voltage [V]	Temperature characteristics		Capacitance [F]	Capacitance tolerance [%]	tan δ [%]	HTLT	Thickness ³ [mm]	Note
								Rated voltage x %		
MSASS31QHB5102□TNA01	SMK316 BJ102□F-T	630	B	X5R ⁺	1000 p	±10, ±20	2.5	120	1.15±0.10	
MSASS31QHB5152□TNA01	SMK316 BJ152□F-T									
MSASS31QHB5222□TNA01	SMK316 BJ222□F-T		B	X5R ⁺	2200 p	±10, ±20	2.5	120	1.15±0.10	
MSASS31QHB5332□TNA01	SMK316 BJ332□F-T									
MSASS31QHB5472□TNA01	SMK316 BJ472□F-T		B	X5R ⁺	3300 p	±10, ±20	2.5	120	1.15±0.10	
MSASS31QHB5682□TNA01	SMK316 BJ682□F-T									
MSASS31QHB5103□TNA01	SMK316 BJ103□F-T		B	X5R ⁺	4700 p	±10, ±20	2.5	120	1.15±0.10	
		B	X5R ⁺	6800 p	±10, ±20	2.5	120	1.15±0.10		
		B	X5R ⁺	0.01 μ	±10, ±20	2.5	120	1.15±0.10		

▶ This catalog contains the typical specification only due to the limitation of space. When you consider the purchase of our products, please check our specification.
For details of each product (characteristics graph, reliability information, precautions for use, and so on), see our Web site (<http://www.ty-top.com/>).

PART NUMBER

【Temperature Characteristic C7 : X7S(-55~+125°C)】 1.6mm thickness

New part number	Old part number (for reference)	Rated voltage [V]	Temperature characteristics		Capacitance [F]	Capacitance tolerance [%]	tan δ [%]	HTLT	Thickness ³ [mm]	Note
								Rated voltage x %		
MSASH31LAC7225□TCA01	HMK316AC7225□L-TE	100		X7S	2.2 μ	±10, ±20	3.5	150	1.6±0.20	

【Temperature Characteristic B7 : X7R(-55~+125°C)】 1.6mm thickness

New part number	Old part number (for reference)	Rated voltage [V]	Temperature characteristics		Capacitance [F]	Capacitance tolerance [%]	tan δ [%]	HTLT	Thickness ³ [mm]	Note
								Rated voltage x %		
MSASH31LSB7473□TNA01	HMK316 B7473□L-T	100		X7R	0.047 μ	±10, ±20	3.5	200	1.6±0.20	
MSASH31LSB7683□TNA01	HMK316 B7683□L-T			X7R	0.068 μ	±10, ±20	3.5	200	1.6±0.20	
MSASH31LSB7104□TNA01	HMK316 B7104□L-T			X7R	0.1 μ	±10, ±20	3.5	200	1.6±0.20	
MSASH31LSB7154□TNA01	HMK316 B7154□L-T			X7R	0.15 μ	±10, ±20	3.5	200	1.6±0.20	
MSASH31LSB7224□TNA01	HMK316 B7224□L-T			X7R	0.22 μ	±10, ±20	3.5	200	1.6±0.20	
MSASH31LSB7334□TNA01	HMK316 B7334□L-T			X7R	0.33 μ	±10, ±20	3.5	200	1.6±0.20	
MSASH31LSB7474□TNA01	HMK316 B7474□L-T			X7R	0.47 μ	±10, ±20	3.5	200	1.6±0.20	
MSASH31LSB7105□TNA01	HMK316 B7105□L-T			X7R	1 μ	±10, ±20	3.5	200	1.6±0.20	
MSASQ31LSB7333□TNA01	QMK316 B7333□L-T			X7R	0.033 μ	±10, ±20	2.5	150	1.6±0.20	
MSASQ31LSB7473□TNA01	QMK316 B7473□L-T		250		X7R	0.047 μ	±10, ±20	2.5	150	1.6±0.20
MSASQ31LSB7683□TNA01	QMK316 B7683□L-T			X7R	0.068 μ	±10, ±20	2.5	150	1.6±0.20	
MSASQ31LSB7104□TNA01	QMK316 B7104□L-T			X7R	0.1 μ	±10, ±20	2.5	150	1.6±0.20	
MSASS31LSB7153□TNA01	SMK316 B7153□L-T	630		X7R	0.015 μ	±10, ±20	2.5	120	1.6±0.20	
MSASS31LSB7223□TNA01	SMK316 B7223□L-T			X7R	0.022 μ	±10, ±20	2.5	120	1.6±0.20	
MSASS31LAB7333□TNA01	SMK316AB7333□L-T			X7R	0.033 μ	±10, ±20	2.5	120	1.6±0.20	
MSASS31LAB7473□TNA01	SMK316AB7473□L-T		X7R	0.047 μ	±10, ±20	2.5	120	1.6±0.20		

【Temperature Characteristic B7 : X7R(-55~+125°C)】 1.15mm thickness

New part number	Old part number (for reference)	Rated voltage [V]	Temperature characteristics		Capacitance [F]	Capacitance tolerance [%]	tan δ [%]	HTLT	Thickness ³ [mm]	Note
								Rated voltage x %		
MSASS31QHB7102□TNA01	SMK316 B7102□F-T	630		X7R	1000 p	±10, ±20	2.5	120	1.15±0.10	
MSASS31QHB7152□TNA01	SMK316 B7152□F-T			X7R	1500 p	±10, ±20	2.5	120	1.15±0.10	
MSASS31QHB7222□TNA01	SMK316 B7222□F-T			X7R	2200 p	±10, ±20	2.5	120	1.15±0.10	
MSASS31QHB7332□TNA01	SMK316 B7332□F-T			X7R	3300 p	±10, ±20	2.5	120	1.15±0.10	
MSASS31QHB7472□TNA01	SMK316 B7472□F-T			X7R	4700 p	±10, ±20	2.5	120	1.15±0.10	
MSASS31QHB7682□TNA01	SMK316 B7682□F-T			X7R	6800 p	±10, ±20	2.5	120	1.15±0.10	
MSASS31QHB7103□TNA01	SMK316 B7103□F-T			X7R	0.01 μ	±10, ±20	2.5	120	1.15±0.10	

【Temperature Characteristic SD : Standard(-55~+125°C)】 1.6mm thickness

New part number	Old part number (for reference)	Rated voltage [V]	Temperature characteristics		Capacitance [F]	Capacitance tolerance [%]	tan δ [%]	HTLT	Thickness ³ [mm]	Note
								Rated voltage x %		
MSASH31LSSD223KTNA01	HMK316 SD223KL-T	100		Standard Type	0.022 μ	±10	0.1	200	1.6±0.20	
MSASQ31LSSD103KTNA01	QMK316 SD103KL-T	250		Standard Type	0.01 μ	±10	0.1	150	1.6±0.20	

3225TYPE

【Temperature Characteristic B5(BJ) : B(-25~+85°C)/X5R(-55~+85°C)】 2.5mm thickness

New part number	Old part number (for reference)	Rated voltage [V]	Temperature characteristics		Capacitance [F]	Capacitance tolerance [%]	tan δ [%]	HTLT	Thickness ³ [mm]	Note
								Rated voltage x %		
MSASH32MSB5225□PNA01	HMK325 BJ225□M-P	100	B	X5R ⁺	2.2 μ	±10, ±20	3.5	200	2.5±0.20	
MSASH32MSB5475□PCA01	HMK325 BJ475□M-PE		B	X5R ⁺	4.7 μ	±10, ±20	3.5	150	2.5±0.20	

【Temperature Characteristic B5(BJ) : B(-25~+85°C)/X5R(-55~+85°C)】 1.9mm thickness

New part number	Old part number (for reference)	Rated voltage [V]	Temperature characteristics		Capacitance [F]	Capacitance tolerance [%]	tan δ [%]	HTLT	Thickness ³ [mm]	Note	
								Rated voltage x %			
MSASH32NSB5154□TNA01	HMK325 BJ154□N-T	100	B	X5R ⁺	0.15 μ	±10, ±20	3.5	200	1.9±0.20		
MSASH32NSB5224□TNA01	HMK325 BJ224□N-T		B	X5R ⁺	0.22 μ	±10, ±20	3.5	200	1.9±0.20		
MSASH32NSB5334□TNA01	HMK325 BJ334□N-T		B	X5R ⁺	0.33 μ	±10, ±20	3.5	200	1.9±0.20		
MSASH32NSB5474□TNA01	HMK325 BJ474□N-T		B	X5R ⁺	0.47 μ	±10, ±20	3.5	200	1.9±0.20		
MSASH32NSB5684□TNA01	HMK325 BJ684□N-T		B	X5R ⁺	0.68 μ	±10, ±20	3.5	200	1.9±0.20		
MSASH32NSB5105□TNA01	HMK325 BJ105□N-T		B	X5R ⁺	1 μ	±10, ±20	3.5	200	1.9±0.20		
MSASH32NSB5475□TCA01	HMK325 BJ475□N-TE		B	X5R ⁺	4.7 μ	±10, ±20	3.5	150	1.9±0.20		
MSASQ32NSB5473□TNA01	QMK325 BJ473□N-T		250	B	X5R ⁺	0.047 μ	±10, ±20	2.5	150	1.9±0.20	
MSASQ32NSB5104□TNA01	QMK325 BJ104□N-T			B	X5R ⁺	0.1 μ	±10, ±20	2.5	150	1.9±0.20	
MSASQ32NSB5154□TNA01	QMK325 BJ154□N-T			B	X5R ⁺	0.15 μ	±10, ±20	2.5	150	1.9±0.20	
MSASQ32NSB5224□TNA01	QMK325 BJ224□N-T	630	B	X5R ⁺	0.22 μ	±10, ±20	2.5	150	1.9±0.20		
MSASS32NSB5223□TNA01	SMK325 BJ223□N-T		B	X5R ⁺	0.022 μ	±10, ±20	2.5	120	1.9±0.20		
MSASS32NSB5333□TNA01	SMK325 BJ333□N-T		B	X5R ⁺	0.033 μ	±10, ±20	2.5	120	1.9±0.20		
MSASS32NSB5473□TNA01	SMK325 BJ473□N-T		B	X5R ⁺	0.047 μ	±10, ±20	2.5	120	1.9±0.20		

【Temperature Characteristic B5(BJ) : B(-25~+85°C)/X5R(-55~+85°C)】 1.15mm thickness

New part number	Old part number (for reference)	Rated voltage [V]	Temperature characteristics		Capacitance [F]	Capacitance tolerance [%]	tan δ [%]	HTLT	Thickness ³ [mm]	Note
								Rated voltage x %		
MSASH32QJB5104□TNA01	HMK325 BJ104□F-T	100	B	X5R ⁺	0.1 μ	±10, ±20	3.5	200	1.15±0.10	

【Temperature Characteristic B7 : X7R(-55~+125°C)】 2.5mm thickness

New part number	Old part number (for reference)	Rated voltage [V]	Temperature characteristics		Capacitance [F]	Capacitance tolerance [%]	tan δ [%]	HTLT	Thickness ³ [mm]	Note
								Rated voltage x %		
MSASH32MSB7225□PNA01	HMK325 B7225□M-P	100		X7R	2.2 μ	±10, ±20	3.5	200	2.5±0.20	

▶ This catalog contains the typical specification only due to the limitation of space. When you consider the purchase of our products, please check our specification.
For details of each product (characteristics graph, reliability information, precautions for use, and so on), see our Web site (<http://www.ty-top.com/>).

PART NUMBER

【Temperature Characteristic B7 : X7R(-55~+125°C)】 1.9mm thickness

New part number	Old part number (for reference)	Rated voltage [V]	Temperature characteristics	Capacitance [F]	Capacitance tolerance [%]	tan δ [%]	HTLT	Thickness ^{*3} [mm]	Note
							Rated voltage x %		
MSASH32NSB7154□TNA01	HMK325 B7154□N-T	100	X7R	0.15 μ	±10, ±20	3.5	200	1.9±0.20	
MSASH32NSB7224□TNA01	HMK325 B7224□N-T		X7R	0.22 μ	±10, ±20	3.5	200	1.9±0.20	
MSASH32NSB7334□TNA01	HMK325 B7334□N-T		X7R	0.33 μ	±10, ±20	3.5	200	1.9±0.20	
MSASH32NSB7474□TNA01	HMK325 B7474□N-T		X7R	0.47 μ	±10, ±20	3.5	200	1.9±0.20	
MSASH32NSB7684□TNA01	HMK325 B7684□N-T		X7R	0.68 μ	±10, ±20	3.5	200	1.9±0.20	
MSASH32NSB7105□TNA01	HMK325 B7105□N-T		X7R	1 μ	±10, ±20	3.5	200	1.9±0.20	
MSASQ32NSB7473□TNA01	QMK325 B7473□N-T	250	X7R	0.047 μ	±10, ±20	2.5	150	1.9±0.20	
MSASQ32NSB7104□TNA01	QMK325 B7104□N-T		X7R	0.1 μ	±10, ±20	2.5	150	1.9±0.20	
MSASQ32NSB7154□TNA01	QMK325 B7154□N-T		X7R	0.15 μ	±10, ±20	2.5	150	1.9±0.20	
MSASQ32NSB7224□TNA01	QMK325 B7224□N-T		X7R	0.22 μ	±10, ±20	2.5	150	1.9±0.20	
MSASS32NSB7223□TNA01	SMK325 B7223□N-T		X7R	0.022 μ	±10, ±20	2.5	120	1.9±0.20	
MSASS32NSB7333□TNA01	SMK325 B7333□N-T		X7R	0.033 μ	±10, ±20	2.5	120	1.9±0.20	
MSASS32NSB7473□TNA01	SMK325 B7473□N-T	630	X7R	0.047 μ	±10, ±20	2.5	120	1.9±0.20	

【Temperature Characteristic C7 : X7S(-55~+125°C)】 2.5mm thickness

New part number	Old part number (for reference)	Rated voltage [V]	Temperature characteristics	Capacitance [F]	Capacitance tolerance [%]	tan δ [%]	HTLT	Thickness ^{*3} [mm]	Note
							Rated voltage x %		
MSASH32MSC7475□PCA01	HMK325 C7475□M-PE	100	X7S	4.7 μ	±10, ±20	3.5	150	2.5±0.20	

【Temperature Characteristic C7 : X7S(-55~+125°C)】 1.9mm thickness

New part number	Old part number (for reference)	Rated voltage [V]	Temperature characteristics	Capacitance [F]	Capacitance tolerance [%]	tan δ [%]	HTLT	Thickness ^{*3} [mm]	Note
							Rated voltage x %		
MSASH32NSC7475□TCA01	HMK325 C7475□N-TE	100	X7S	4.7 μ	±10, ±20	3.5	150	1.9±0.20	

【Temperature Characteristic B7 : X7R(-55~+125°C)】 1.15mm thickness

New part number	Old part number (for reference)	Rated voltage [V]	Temperature characteristics	Capacitance [F]	Capacitance tolerance [%]	tan δ [%]	HTLT	Thickness ^{*3} [mm]	Note
							Rated voltage x %		
MSASH32QJB7104□TNA01	HMK325 B7104□F-T	100	X7R	0.1 μ	±10, ±20	3.5	200	1.15±0.10	

4532TYPE

【Temperature Characteristic B5(BJ) : B(-25~+85°C)/X5R(-55~+85°C)】 2.5mm thickness

New part number	Old part number (for reference)	Rated voltage [V]	Temperature characteristics	Capacitance [F]	Capacitance tolerance [%]	tan δ [%]	HTLT	Thickness ^{*3} [mm]	Note
							Rated voltage x %		
MSASH45MSB5474□TNA01	HMK432 BJ474□M-T	100	B	X5R ^{*1}	0.47 μ	±10, ±20	3.5	200	2.5±0.20
MSASH45MSB5105□TNA01	HMK432 BJ105□M-T		B	X5R ^{*1}	1 μ	±10, ±20	3.5	200	2.5±0.20
MSASH45MSB5155□TNA01	HMK432 BJ155□M-T		B	X5R ^{*1}	1.5 μ	±10, ±20	3.5	200	2.5±0.20
MSASH45MSB5225□TNA01	HMK432 BJ225□M-T		B	X5R ^{*1}	2.2 μ	±10, ±20	3.5	200	2.5±0.20
MSASQ45MSB5104□TNA01	QMK432 BJ104□M-T		B	X5R ^{*1}	0.1 μ	±10, ±20	2.5	150	2.5±0.20
MSASQ45MSB5224□TNA01	QMK432 BJ224□M-T		B	X5R ^{*1}	0.22 μ	±10, ±20	2.5	150	2.5±0.20
MSASQ45MSB5334□TNA01	QMK432 BJ334□M-T	250	B	X5R ^{*1}	0.33 μ	±10, ±20	2.5	150	2.5±0.20
MSASQ45MSB5474□TNA01	QMK432 BJ474□M-T		B	X5R ^{*1}	0.47 μ	±10, ±20	2.5	150	2.5±0.20
MSASQ45MSB5473□TNA01	QMK432 BJ473□M-T		B	X5R ^{*1}	0.47 μ	±10, ±20	2.5	150	2.5±0.20
MSASS45MSB5683□TNA01	SMK432 BJ683□M-T		B	X5R ^{*1}	0.068 μ	±10, ±20	2.5	120	2.5±0.20
MSASS45MSB5104□TNA01	SMK432 BJ104□M-T		B	X5R ^{*1}	0.1 μ	±10, ±20	2.5	120	2.5±0.20
			B	X5R ^{*1}	0.1 μ	±10, ±20	2.5	120	2.5±0.20

【Temperature Characteristic B7 : X7R(-55~+125°C)】 2.5mm thickness

New part number	Old part number (for reference)	Rated voltage [V]	Temperature characteristics	Capacitance [F]	Capacitance tolerance [%]	tan δ [%]	HTLT	Thickness ^{*3} [mm]	Note
							Rated voltage x %		
MSASH45MSB7474□TNA01	HMK432 B7474□M-T	100	X7R	0.47 μ	±10, ±20	3.5	200	2.5±0.20	
MSASH45MSB7105□TNA01	HMK432 B7105□M-T		X7R	1 μ	±10, ±20	3.5	200	2.5±0.20	
MSASH45MSB7155□TNA01	HMK432 B7155□M-T		X7R	1.5 μ	±10, ±20	3.5	200	2.5±0.20	
MSASH45MSB7225□TNA01	HMK432 B7225□M-T		X7R	2.2 μ	±10, ±20	3.5	200	2.5±0.20	
MSASQ45MSB7104□TNA01	QMK432 B7104□M-T		X7R	0.1 μ	±10, ±20	2.5	150	2.5±0.20	
MSASQ45MSB7224□TNA01	QMK432 B7224□M-T		X7R	0.22 μ	±10, ±20	2.5	150	2.5±0.20	
MSASQ45MSB7334□TNA01	QMK432 B7334□M-T	250	X7R	0.33 μ	±10, ±20	2.5	150	2.5±0.20	
MSASQ45MSB7474□TNA01	QMK432 B7474□M-T		X7R	0.47 μ	±10, ±20	2.5	150	2.5±0.20	
MSASS45MSB7473□TNA01	SMK432 B7473□M-T		X7R	0.047 μ	±10, ±20	2.5	120	2.5±0.20	
MSASS45MSB7683□TNA01	SMK432 B7683□M-T		X7R	0.068 μ	±10, ±20	2.5	120	2.5±0.20	
MSASS45MSB7104□TNA01	SMK432 B7104□M-T		X7R	0.1 μ	±10, ±20	2.5	120	2.5±0.20	
			X7R	0.1 μ	±10, ±20	2.5	120	2.5±0.20	

【Temperature Characteristic B7 : X7R(-55~+125°C)】 2.0mm thickness

New part number	Old part number (for reference)	Rated voltage [V]	Temperature characteristics	Capacitance [F]	Capacitance tolerance [%]	tan δ [%]	HTLT	Thickness ^{*3} [mm]	Note
							Rated voltage x %		
MSASX45YAB7222KTCA01	XMK432 B7222KY-TE	2000	X7R	2200 p	±10	2.5	110	2.0+0/-0.30	
MSASX45YAB7472KTCA01	XMK432 B7472KY-TE		X7R	4700 p	±10	2.5	110	2.0+0/-0.30	

* This catalog contains the typical specification only due to the limitation of space. When you consider the purchase of our products, please check our specification.
For details of each product (characteristics graph, reliability information, precautions for use, and so on), see our Web site (<http://www.ty-top.com/>).

PART NUMBER

LW Reversal Decoupling Low ESL Capacitors (LWDC™) for General Electronic Equipment for Consumer

0510TYPE

【Temperature Characteristic B5(BJ) : X5R(-55~+85°C)】 0.3mm thickness

New part number	Old part number (for reference)	Rated voltage [V]	Temperature characteristics	Capacitance [F]	Capacitance tolerance [%]	tan δ [%]	HHLT		Note
							Rated voltage x %	Thickness ^{*3} [mm]	
MSRLT103SB5104MFNA01	TWK105 BJ104MP-F	25	X5R	0.1 μ	±20	5	150	0.3±0.05	
MSRLE103SB5224MFNA01	EWK105 BJ224MP-F	16	X5R	0.22 μ	±20	10	150	0.3±0.05	
MSRLL103SB5474MFNA01	LWK105 BJ474MP-F	10	X5R	0.47 μ	±20	10	150	0.3±0.05	
MSRLJ103SB5104MFNA01	JWK105 BJ104MP-F	6.3	X5R ^{*1}	0.1 μ	±20	5	150	0.3±0.05	
MSRLJ103SB5474MFNA01	JWK105 BJ474MP-F		X5R ^{*1}	0.47 μ	±20	10	150	0.3±0.05	
MSRLJ103SB5105MFNA01	JWK105 BJ105MP-F		X5R	1 μ	±20	10	150	0.3±0.05	
MSRLJ103SB5225MFNA01	JWK105 BJ225MP-F		X5R	2.2 μ	±20	10	150	0.3±0.05	

【Temperature Characteristic C6 : X6S(-55~+105°C), C7 : X7S(-55~+125°C)】 0.3mm thickness

New part number	Old part number (for reference)	Rated voltage [V]	Temperature characteristics	Capacitance [F]	Capacitance tolerance [%]	tan δ [%]	HHLT		Note
							Rated voltage x %	Thickness ^{*3} [mm]	
MSRLE103SC6104MFNA01	EWK105 C6104MP-F	16	X6S	0.1 μ	±20	5	150	0.3±0.05	
MSRLL103SC7104MFNA01	LWK105 C7104MP-F	10	X7S	0.1 μ	±20	5	150	0.3±0.05	
MSRLL103SC6224MFNA01	LWK105 C6224MP-F		X6S	0.22 μ	±20	10	150	0.3±0.05	
MSRLJ103SC7104MFNA01	JWK105 C7104MP-F	6.3	X7S	0.1 μ	±20	5	150	0.3±0.05	
MSRLJ103SC7224MFNA01	JWK105 C7224MP-F		X7S	0.22 μ	±20	10	150	0.3±0.05	
MSRLJ103SC6474MFNA01	JWK105 C6474MP-F		X6S	0.47 μ	±20	10	150	0.3±0.05	
MSRLA103SC6224MFNA01	AWK105 C6224MP-F		X6S	0.22 μ	±20	10	150	0.3±0.05	
MSRLA103SC6474MFNA01	AWK105 C6474MP-F	4	X6S	0.47 μ	±20	10	150	0.3±0.05	
MSRLA103SC6105MFNA01	AWK105 C6105MP-F		X6S	1 μ	±20	10	150	0.3±0.05	
MSRLA103SC6225MFNA01	AWK105 C6225MP-F		X6S	2.2 μ	±20	10	150	0.3±0.05	

0816TYPE

【Temperature Characteristic B5(BJ) : X5R(-55~+85°C)】 0.5mm thickness

New part number	Old part number (for reference)	Rated voltage [V]	Temperature characteristics	Capacitance [F]	Capacitance tolerance [%]	tan δ [%]	HHLT		Note
							Rated voltage x %	Thickness ^{*3} [mm]	
MSRLT165SB5104MTNA01	TWK107 BJ104MV-T	25	X5R ^{*1}	0.1 μ	±20	5	150	0.5±0.05	
MSRLE165SB5224MTNA01	EWK107 BJ224MV-T	16	X5R ^{*1}	0.22 μ	±20	5	150	0.5±0.05	
MSRLE165SB5474MTNA01	EWK107 BJ474MV-T		X5R ^{*1}	0.47 μ	±20	5	150	0.5±0.05	
MSRLL165SB5105MTNA01	LWK107 BJ105MV-T	10	X5R	1 μ	±20	10	150	0.5±0.05	
MSRLL165SB5225MTNA01	LWK107 BJ225MV-T		X5R	2.2 μ	±20	10	150	0.5±0.05	
MSRLJ165SB5105MTNA01	JWK107 BJ105MV-T		X5R ^{*1}	1 μ	±20	10	150	0.5±0.05	
MSRLJ165SB5225MTNA01	JWK107 BJ225MV-T		X5R	2.2 μ	±20	10	150	0.5±0.05	
MSRLJ165SB5475MTNA01	JWK107 BJ475MV-T	6.3	X5R	4.7 μ	±20	10	150	0.5±0.05	
MSRLA165SB5106MTNA01	AWK107 BJ106MV-T		X5R	10 μ	±20	10	150	0.5±0.05	

【Temperature Characteristic B7 : X7R(-55~+125°C), C6 : X6S(-55~+105°C), C7 : X7S(-55~+125°C)】 0.5mm thickness

New part number	Old part number (for reference)	Rated voltage [V]	Temperature characteristics	Capacitance [F]	Capacitance tolerance [%]	tan δ [%]	HHLT		Note
							Rated voltage x %	Thickness ^{*3} [mm]	
MSRLT165SB7104MTNA01	TWK107 B7104MV-T	25	X7R	0.1 μ	±20	5	150	0.5±0.05	
MSRLE165SB7224MTNA01	EWK107 B7224MV-T	16	X7R	0.22 μ	±20	5	150	0.5±0.05	
MSRLE165SB7474MTNA01	EWK107 B7474MV-T		X7R	0.47 μ	±20	5	150	0.5±0.05	
MSRLJ165SC7105MTNA01	JWK107 C7105MV-T	6.3	X7S	1 μ	±20	10	150	0.5±0.05	
MSRLA165SC7225MTNA01	AWK107 C7225MV-T		X7S	2.2 μ	±20	10	150	0.5±0.05	
MSRLA165SC6475MTNA01	AWK107 C6475MV-T	4	X6S	4.7 μ	±20	10	150	0.5±0.05	
MSRLP165SC6106MTNA01	PWK107 C6106MV-T		X6S	10 μ	±20	10	150	0.5±0.05	

1220TYPE

【Temperature Characteristic B5(BJ) : X5R(-55~+85°C)】 0.85mm thickness

New part number	Old part number (for reference)	Rated voltage [V]	Temperature characteristics	Capacitance [F]	Capacitance tolerance [%]	tan δ [%]	HHLT		Note
							Rated voltage x %	Thickness ^{*3} [mm]	
MSRLT219SB5475□TNA01	TWK212 BJ475□D-T	25	X5R	4.7 μ	±10, ±20	10	150	0.85±0.10	
MSRLE219SB5106MTNA01	EWK212 BJ106MD-T	16	X5R	10 μ	±20	10	150	0.85±0.10	
MSRLL219SB5475□TNA01	LWK212 BJ475□D-T	10	X5R	4.7 μ	±10, ±20	10	150	0.85±0.10	
MSRLL219SB5106MTNA01	LWK212 BJ106MD-T		X5R	10 μ	±20	10	150	0.85±0.10	
MSRLJ219SB5226MTNA01	JWK212 BJ226MD-T	6.3	X5R	22 μ	±20	10	150	0.85±0.10	

【Temperature Characteristic B7 : X7R(-55~+125°C), C6 : X6S(-55~+105°C)】 0.85mm thickness

New part number	Old part number (for reference)	Rated voltage [V]	Temperature characteristics	Capacitance [F]	Capacitance tolerance [%]	tan δ [%]	HHLT		Note
							Rated voltage x %	Thickness ^{*3} [mm]	
MSRLT219SB7225□TNA01	TWK212 B7225□D-T	25	X7R	2.2 μ	±10, ±20	5	150	0.85±0.10	
MSRLE219SC6475□TNA01	EWK212 C6475□D-T	16	X6S	4.7 μ	±10, ±20	10	150	0.85±0.10	
MSRLL219SC6106MTNA01	LWK212 C6106MD-T	10	X6S	10 μ	±20	10	150	0.85±0.10	
MSRLA219SC6226MTNA01	AWK212 C6226MD-T	4	X6S	22 μ	±20	10	150	0.85±0.10	

* This catalog contains the typical specification only due to the limitation of space. When you consider the purchase of our products, please check our specification.
For details of each product (characteristics graph, reliability information, precautions for use, and so on), see our Web site (<http://www.ty-top.com/>).

Multilayer Ceramic Capacitors

PACKAGING

① Minimum Quantity

● Taped package

Type			Thickness		Standard Quantity [pcs]	
Code	JIS(mm)	EIA(inch)	[mm]	Code	Paper tape	Embossed tape
02	0201	008004	0.125	1	—	50000
04	0402	01005	0.2	2	—	40000
06	0603	0201	0.3	3	15000	—
1L	1005	0402	0.13	H	—	20000
			0.18	E	—	15000
			0.2	2	20000	—
			0.3	3	15000	—
10	1005	0402	0.5	5	10000	—
	0510 ※	0204	0.3	3	10000	—
16	1608	0603	0.45	K	4000	—
			0.7	7		
			0.8	8		
			0.8	8	3000 (Soft Termination)	3000 (Soft Termination)
	0816 ※	0306	0.5	5	—	4000
21	2012	0805	0.85	9	4000	—
			1.25	G	—	3000
			1.25	G	—	2000 (Soft Termination)
1220 ※	0508	0.85	9	4000	—	
31	3216	1206	0.85	9	4000	—
			1.15	Q	—	3000
			1.6	L	—	2000
32	3225	1210	0.85	9	—	2000
			1.15	Q		
			1.9	N		
			2.0 max	Y		
			2.5	M	—	500(T), 1000(P)
45	4532	1812	2.0 max	Y	—	1000
			2.5	M	—	500

注: ※LW Reverse type (MSRL, MCRL, MBRL, MLRL, MMRL)

② Taping material

※ No bottom tape for pressed carrier tape

- Card board carrier tape
- Embossed tape

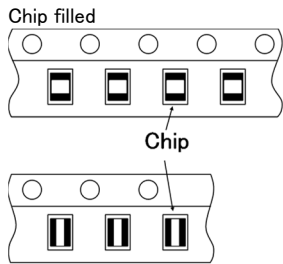
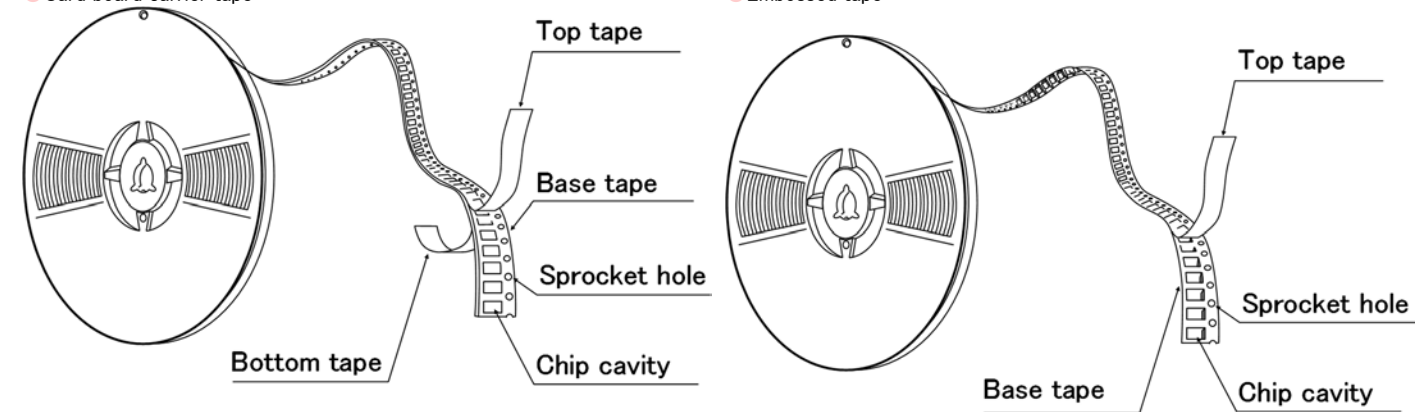

※ LW Reverse type.

③ Representative taping dimensions

● Paper Tape (8mm wide)

● Pressed carrier tape (2mm pitch)

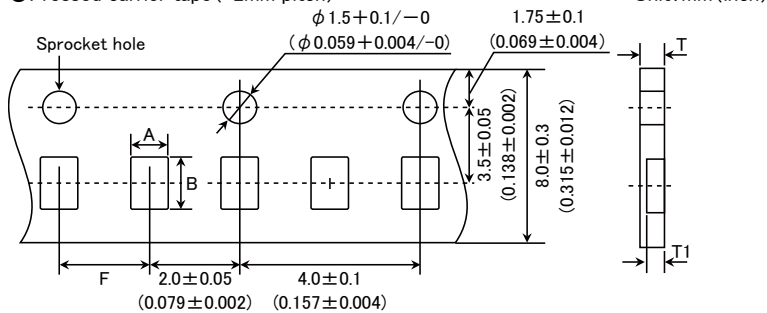

Type(EIA)	Chip Cavity		Insertion Pitch F	Tape Thickness	
	A	B		T	T1
0603 (0201)	0.37	0.67	2.0 ± 0.05	0.45max.	0.42max.
0510 (0204) ※	0.65	1.15		0.4max.	0.3max.
1005 (0402) (*1 2)				0.45max.	0.42max.
1005 (0402) (*1 3)					

Note *1 Thickness, 2:0.2mm, 3:0.3mm. ※ LW Reverse type.

Unit: mm

● Punched carrier tape (2mm pitch)

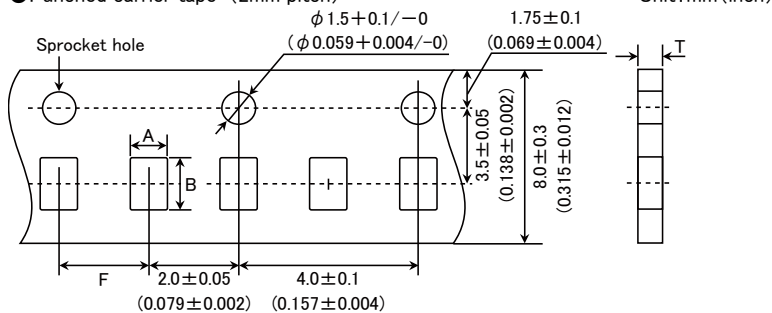

Type(EIA)	Chip Cavity		Insertion Pitch F	Tape Thickness
	A	B		T
1005 (0402)	0.65	1.15	2.0 ± 0.05	0.8max.

Unit: mm

► This catalog contains the typical specification only due to the limitation of space. When you consider the purchase of our products, please check our specification. For details of each product (characteristics graph, reliability information, precautions for use, and so on), see our Web site (<http://www.ty-top.com/>).

● Punched carrier tape (4mm pitch)

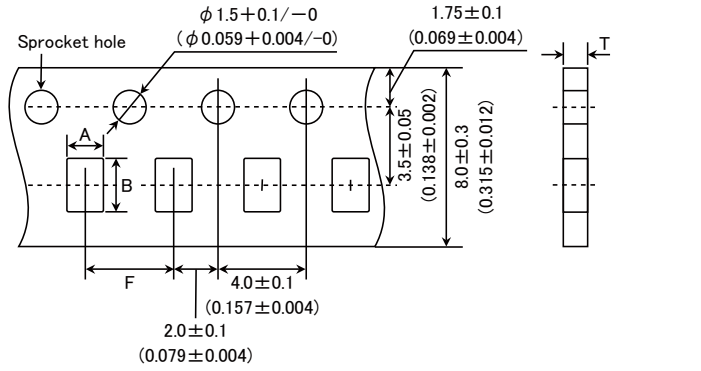

Type(EIA)	Chip Cavity		Insertion Pitch F	Tape Thickness	
	A	B		K	T
1608 (0603)	1.0	1.8	4.0 ± 0.1	1.1max.	
0816 (0306) ※				1.1max.	
2012 (0805)				1.1max.	
1220 (0508) ※	1.65	2.4	4.0 ± 0.1	1.1max.	
3216 (1206)	2.0	3.6		1.1max.	

Note: Taping size might be different depending on the size of the product. ※ LW Reverse type.

Unit: mm

● Embossed tape (4mm wide)

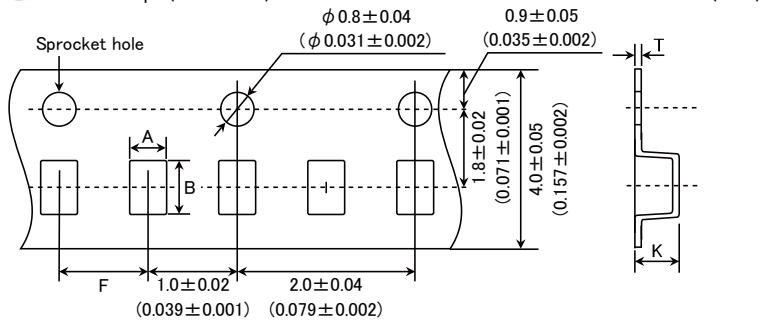

Type(EIA)	Chip Cavity		Insertion Pitch F	Tape Thickness	
	A	B		K	T
0201 (008004)	0.135	0.27	1.0 ± 0.02	0.5max.	0.25max.
0402 (01005)	0.23	0.43			

Unit: mm

● Embossed tape (8mm wide)

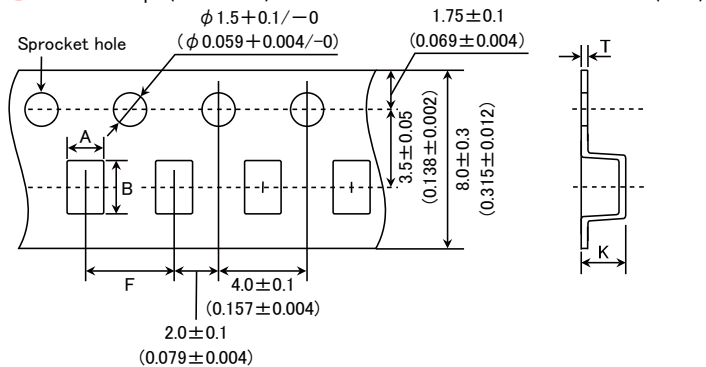

Type(EIA)	Chip Cavity		Insertion Pitch F	Tape Thickness	
	A	B		K	T
1005 (0402)	0.6	1.1	2.0 ± 0.1	0.6max	0.2 ± 0.1
0816 (0306) ※	1.0	1.8	4.0 ± 0.1	1.3max.	0.25 ± 0.1
2012 (0805)	1.65	2.4		3.4max.	0.6max.
3216 (1206)	2.0	3.6			
3225 (1210)	2.8	3.6			

Note: ※ LW Reverse type.

Unit: mm

► This catalog contains the typical specification only due to the limitation of space. When you consider the purchase of our products, please check our specification. For details of each product (characteristics graph, reliability information, precautions for use, and so on), see our Web site (<http://www.ty-top.com/>).

● Embossed tape (12mm wide) Unit: mm (inch)

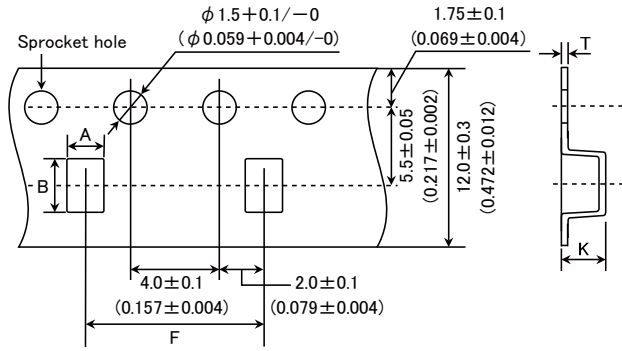

Type(EIA)	Chip Cavity		Insertion Pitch	Tape Thickness	
	A	B		K	T
3225 (1210)	3.1	4.0	8.0 ± 0.1	4.0max.	0.6max.
4532 (1812)	3.7	4.9	8.0 ± 0.1	4.0max.	0.6max.

Unit: mm

④ Trailer and Leader

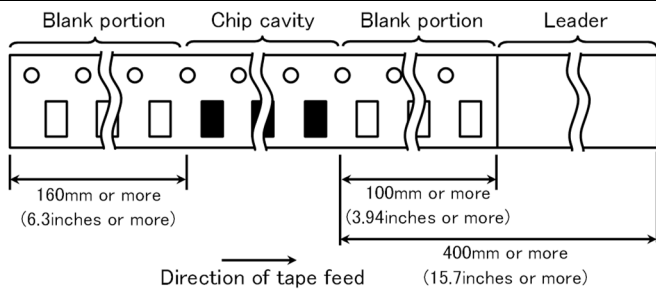

⑤ Reel size

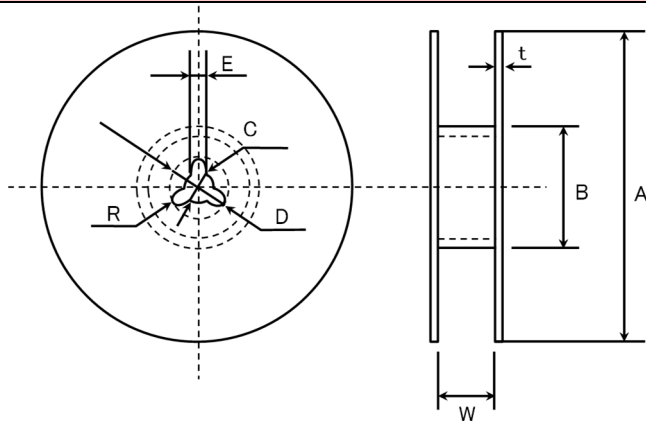

A	B	C	D	E	R
$\phi 178 \pm 2.0$	$\phi 50 \text{min.}$	$\phi 13.0 \pm 0.2$	$\phi 21.0 \pm 0.8$	2.0 ± 0.5	1.0

	T	W
4mm wide tape	1.5max.	5 ± 1.0
8mm wide tape	2.5max.	10 ± 1.5
12mm wide tape	2.5max.	14 ± 1.5

Unit: mm

⑥ Top Tape Strength

The top tape requires a peel-off force of 0.1 to 0.7N in the direction of the arrow as illustrated below.

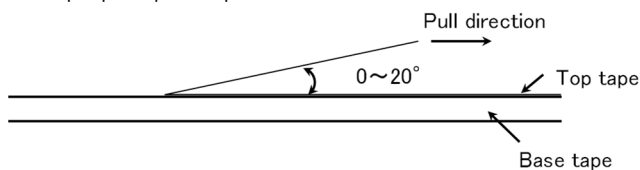

▶ This catalog contains the typical specification only due to the limitation of space. When you consider the purchase of our products, please check our specification. For details of each product (characteristics graph, reliability information, precautions for use, and so on), see our Web site (<http://www.ty-top.com/>).

Multilayer Ceramic Capacitors for General Electronic Equipment for Consumer
Multilayer Ceramic Capacitors
for Medical Devices classified as GHTF Classes A or B (Japan Classes I or II)

■ RELIABILITY DATA

1. Operating Temperature Range

Specified Value	Temperature Compensating (Class1)	Standard	-55 to +125°C	
		High Frequency Type		
Specified Value	High Permittivity (Class2)		Specification	Temperature Range
		B5	B	-25 to +85°C
			X5R	-55 to +85°C
		B7	X7R	-55 to +125°C
		C6	X6S	-55 to +105°C
	C7	X7S	-55 to +125°C	

2. Storage Conditions

Specified Value	Temperature Compensating (Class1)	Standard	-55 to +125°C	
		High Frequency Type		
Specified Value	High Permittivity (Class2)		Specification	Temperature Range
		B5	B	-25 to +85°C
			X5R	-55 to +85°C
		B7	X7R	-55 to +125°C
		C6	X6S	-55 to +105°C
	C7	X7S	-55 to +125°C	

3. Rated Voltage

Specified Value	Temperature Compensating (Class1)	Standard	50VDC, 25VDC, 16VDC
		High Frequency Type	25VDC, 16VDC
	High Permittivity (Class2)		50VDC, 35VDC, 25VDC, 16VDC, 10VDC, 6.3VDC, 4VDC, 2.5VDC

4. Withstanding Voltage (Between terminals)

Specified Value	Temperature Compensating (Class1)	Standard	No breakdown or damage
		High Frequency Type	
	High Permittivity (Class2)		
Test Methods and Remarks		Class 1	Class 2
	Applied voltage	Rated voltage × 3	Rated voltage × 2.5
	Duration	1 to 5 sec.	
	Charge/discharge current	50mA max.	

5. Insulation Resistance

Specified Value	Temperature Compensating (Class1)	Standard	10000 MΩ min.
		High Frequency Type	
	High Permittivity (Class2) Note 1		$C \leq 0.047 \mu F$: 10000 MΩ min. $C > 0.047 \mu F$: $500 M\Omega \cdot \mu F$ (C: Nominal capacitance)
Test Methods and Remarks	Applied voltage	: Rated voltage	
	Duration	: 60±5 sec.	
	Charge/discharge current	: 50mA max.	

► This catalog contains the typical specification only due to the limitation of space. When you consider the purchase of our products, please check our specification. For details of each product (characteristics graph, reliability information, precautions for use, and so on), see our Web site (<http://www.ty-top.com/>).

6. Capacitance (Tolerance)

Specified Value	Temperature Compensating (Class1)	Standard	$0.2\text{pF} \leq C \leq 5\text{pF} : \pm 0.25\text{pF}$ $5\text{pF} \leq C \leq 10\text{pF} : \pm 0.5\text{pF}$ $C > 10\text{pF} : \pm 5\%$	
		High Frequency Type	Refer to detailed specification	
	High Permittivity (Class2)		$\pm 10\%$ or $\pm 20\%$	
Test Methods and Remarks		Class 1		Class 2
		Standard	High Frequency Type	$C \leq 10 \mu\text{F}$ $C > 10 \mu\text{F}$
	Preconditioning	None		Thermal treatment (at 150°C for 1hr) Note 2
	Measuring frequency	1MHz \pm 10%	1GHz	$1\text{kHz} \pm 10\%$ $120 \pm 10\text{Hz}$
	Measuring voltage Note 1	0.5 to 5Vrms		$1 \pm 0.2\text{Vrms}$ $0.5 \pm 0.1\text{Vrms}$
Bias application	None			

7. Q or Dissipation Factor

Specified Value	Temperature Compensating (Class1)	Standard	$C < 30\text{pF} : Q \geq 400 + 20C$ $C \geq 30\text{pF} : Q \geq 1000$ (C: Nominal capacitance)	
		High Frequency Type	Refer to detailed specification	
	High Permittivity (Class2) Note 1		2.5% max.	
Test Methods and Remarks		Class 1		Class 2
		Standard	High Frequency Type	$C \leq 10 \mu\text{F}$ $C > 10 \mu\text{F}$
	Preconditioning	None		Thermal treatment (at 150°C for 1hr) Note 2
	Measuring frequency	1MHz \pm 10%	1GHz	$1\text{kHz} \pm 10\%$ $120 \pm 10\text{Hz}$
	Measuring voltage Note 1	0.5 to 5Vrms		$1 \pm 0.2\text{Vrms}$ $0.5 \pm 0.1\text{Vrms}$
Bias application	None			

8. Temperature Characteristic (Without voltage application)

Specified Value	Temperature Compensating (Class1)	Standard	Temperature Characteristic [ppm/°C]		Tolerance [ppm/°C]		
			$C \square : 0$	CG(C0G) CH(C0H) CJ(C0J) CK(C0K)	G: ± 30 H: ± 60 J: ± 120 H: ± 250		
	High Frequency Type	Temperature Characteristic [ppm/°C]		Tolerance [ppm/°C]			
			$C \square : 0$	CG(C0G) CH(C0H)	G: ± 30 H: ± 60		
	High Permittivity (Class2)			Specification	Capacitance change	Reference temperature	Temperature Range
			B5	B	$\pm 10\%$	20°C	-25 to +85°C
				X5R	$\pm 15\%$	25°C	-55 to +85°C
			B7	X7R	$\pm 15\%$	25°C	-55 to +125°C
			C6	XS	$\pm 22\%$	25°C	-55 to +105°C
			C7	X7S	$\pm 22\%$	25°C	-55 to +125°C

Test Methods and Remarks	Class 1				
	Capacitance at 20°C and 85°C shall be measured in thermal equilibrium, and the temperature characteristic shall be calculated from the following equation.				
	$\frac{(C_{85} - C_{20})}{C_{20} \times \Delta T} \times 10^6 (\text{ppm}/^\circ\text{C}) \quad \Delta T = 65$				
	Class 2				
	Capacitance at each step shall be measured in thermal equilibrium, and the temperature characteristic shall be calculated from the following equation.				
	Step	B	X5R, X7R, X6S, X7S		
	1	Minimum operating temperature			
	2	20°C	25°C		
	3	Maximum operating temperature			
	$\frac{(C - C_2)}{C_2} \times 100 (\%)$		C : Capacitance in Step 1 or Step 3 C ₂ : Capacitance in Step 2		
	※Measuring frequency and voltage: Refer to detailed specification				

► This catalog contains the typical specification only due to the limitation of space. When you consider the purchase of our products, please check our specification. For details of each product (characteristics graph, reliability information, precautions for use, and so on), see our Web site (<http://www.ty-top.com/>).

9. Deflection

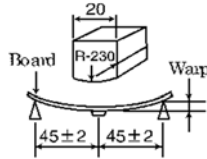
Specified Value	Temperature Compensating (Class1)	Standard	Appearance : No abnormality Capacitance change : Within $\pm 5\%$ or ± 0.5 pF, whichever is larger.	
		High Frequency Type	Appearance : No abnormality Capacitance change : Within ± 0.5 pF	
	High Permittivity (Class2)		Appearance : No abnormality Capacitance change : Within $\pm 12.5\%$	
Test Methods and Remarks	Multilayer Ceramic Capacitors		 <p>(Unit: mm)</p> <p>Capacitance measurement shall be conducted with the board bent</p>	
		0201, 0402, 0603, ※1005 Type		
		The other types		
	Board	Glass epoxy-resin substrate		
	Thickness	0.8mm		1.6mm
	Warp	1mm		
	Duration	10 sec.		
※1005 Type thickness, 2: 0.2mm, 3: 0.3mm.				

10. Adhesive Strength of Terminal Electrodes

Specified Value	Temperature Compensating (Class1)	Standard	No terminal separation or its indication.	
		High Frequency Type		
	High Permittivity (Class2)			
Test Methods and Remarks		0201Type	0402, 0603Type	1005Type or more
	Applied force	1N	2N	5N
	Duration	10 ± 1 sec		30 ± 5 sec

11. Vibration

Specified Value	Temperature Compensating (Class1)	Standard	Initial performance shall be satisfied.
		High Frequency Type	
	High Permittivity (Class2)		
Test Methods and Remarks	Preconditioning	: Thermal treatment (at 150°C for 1hr) Note2 (Only High permittivity)	
	Frequency range	: 10 to 55 Hz	
	Overall amplitude	: 1.5 mm	
	Sweeping method	: 10 to 55 to 10 Hz for 1 min Two hours each in X, Y, Z directions: 6 hrs in total	

12. Solderability

Specified Value	Temperature Compensating (Class1)	Standard	At least 95% of terminal electrode is covered by new solder.
		High Frequency Type	
	High Permittivity (Class2)		
Test Methods and Remarks		Eutectic solder	Lead-free solder
	Solder type	H60A or H63A	Sn-3.0Ag-0.5Cu
	Solder temperature	230 ± 5°C	
	Duration	4 ± 1 sec.	

13. Resistance to Soldering

Specified Value	Temperature Compensating (Class1)	Standard	Appearance : No abnormality Capacitance change : Within $\pm 2.5\%$ or $\pm 0.25\text{pF}$, whichever is larger. Q : Initial value Insulation resistance : Initial value Withstanding voltage (between terminals) : No abnormality	
		High Frequency Type	Appearance : No abnormality Capacitance change : Within $\pm 2.5\%$ or $\pm 0.25\text{pF}$, whichever is larger. Q : Initial value Insulation resistance : Initial value Withstanding voltage (between terminals) : No abnormality	
	High Permittivity (Class2) Note 1		Appearance : No abnormality Capacitance change : Within $\pm 7.5\%$ Dissipation factor : Initial value Insulation resistance : Initial value Withstanding voltage (between terminals) : No abnormality	
Test Methods and Remarks	Class 1			
		0201, 0402, 0603 Type	1005 Type	
	Preconditioning	None		
	Preheating	150°C, 1 to 2 min.	80 to 100°C, 2 to 5 min. 150 to 200°C, 2 to 5 min.	
	Solder temp.	270 \pm 5°C		
	Duration	3 \pm 0.5 sec.		
	Recovery	24 \pm 2 hrs (Standard condition) Note 5		
	Class 2			
		0201, 0402, 0603 Type	1005, 1608, 2012 Type	3216, 3225, 4532 Type
	Preconditioning	Thermal treatment (at 150°C for 1 hr) Note 2		
	Preheating	150°C, 1 to 2 min.	80 to 100°C, 2 to 5 min. 150 to 200°C, 2 to 5 min.	80 to 100°C, 5 to 10 min. 150 to 200°C, 5 to 10 min.
	Solder temp.	270 \pm 5°C		
	Duration	3 \pm 0.5 sec.		
	Recovery	24 \pm 2 hrs (Standard condition) Note 5		

14. Temperature Cycle (Thermal Shock)

Specified Value	Temperature Compensating (Class1)	Standard	Appearance : No abnormality Capacitance change : Within $\pm 2.5\%$ or $\pm 0.25\text{pF}$, whichever is larger. Q : Initial value Insulation resistance : Initial value Withstanding voltage (between terminals) : No abnormality	
		High Frequency Type	Appearance : No abnormality Capacitance change : Within $\pm 2.5\%$ or $\pm 0.25\text{pF}$, whichever is larger. Q : Initial value Insulation resistance : Initial value Withstanding voltage (between terminals) : No abnormality	
	High Permittivity (Class2) Note 1		Appearance : No abnormality Capacitance change : Within $\pm 7.5\%$ Dissipation factor : Initial value Insulation resistance : Initial value Withstanding voltage (between terminals) : No abnormality	
Test Methods and Remarks	Class 1		Class 2	
	Preconditioning	None	Thermal treatment (at 150°C for 1 hr) Note 2	
	1 cycle	Step	Temperature (°C)	Time (min.)
		1	Minimum operating temperature	30 \pm 3
		2	Normal temperature	2 to 3
		3	Maximum operating temperature	30 \pm 3
4	Normal temperature	2 to 3		
Number of cycles	5 times			
Recovery	24 \pm 2 hrs (Standard condition) Note 5			

► This catalog contains the typical specification only due to the limitation of space. When you consider the purchase of our products, please check our specification. For details of each product (characteristics graph, reliability information, precautions for use, and so on), see our Web site (<http://www.ty-top.com/>).

15. Humidity (Steady State)			
Specified Value	Temperature Compensating (Class1)	Standard	Appearance : No abnormality Capacitance change : Within $\pm 5\%$ or $\pm 0.5\text{pF}$, whichever is larger. Q : $C < 10\text{pF} : Q \geq 200 + 10C$ $10 \leq C < 30\text{pF} : Q \geq 275 + 2.5C$ $C \geq 30\text{pF} : Q \geq 350$ (C: Nominal capacitance) Insulation resistance : 1000 M Ω min.
		High Frequency Type	Appearance : No abnormality Capacitance change : Within $\pm 5\%$ or $\pm 0.5\text{pF}$, whichever is larger. Insulation resistance : 1000 M Ω min.
	High Permittivity (Class2) Note 1		Appearance : No abnormality Capacitance change : Within $\pm 12.5\%$ Dissipation factor : 5.0% max. Insulation resistance : 50 M Ω μF or 1000 M Ω whichever is smaller.
Test Methods and Remarks	Preconditioning : Thermal treatment (at 150°C for 1hr) Note2 (Only High permittivity) Temperature : $40 \pm 2^\circ\text{C}$ Humidity : 90 to 95%RH Duration : 500 +24/-0 hrs Recovery : 24 ± 2 hrs under the standard condition Note 1,5		

16. Humidity Loading			
Specified Value	Temperature Compensating (Class1)	Standard	Appearance : No abnormality Capacitance change : Within $\pm 7.5\%$ or $\pm 0.75\text{pF}$, whichever is larger. Q : $C < 30\text{pF} : Q \geq 100 + 10C/3$ $C \geq 30\text{pF} : Q \geq 200$ (C: Nominal capacitance) Insulation resistance : 500 M Ω min.
		High Frequency Type	Appearance : No abnormality Capacitance change : $C \leq 2\text{pF} : \text{Within } \pm 0.4 \text{ pF}$ $C > 2\text{pF} : \text{Within } \pm 0.75 \text{ pF}$ $C > 10\text{pF} : \text{Within } \pm 0.75\% \text{ (C: Nominal capacitance)}$ Insulation resistance : 500 M Ω min.
	High Permittivity (Class2) Note 1		Appearance : No abnormality Capacitance change : Within $\pm 12.5\%$ Dissipation factor : 5.0% max. Insulation resistance : 25 M Ω μF or 500 M Ω , whichever is smaller.
Test Methods and Remarks	Preconditioning : Voltage treatment (Rated voltage are applied for 1 hour at 40°C) Note 1,3 (Only High permittivity) Temperature : $40 \pm 2^\circ\text{C}$ Humidity : 90 to 95%RH Duration : 500 +24/-0 hrs Applied voltage : Rated voltage Charge/discharge current : 50mA max. Recovery : 24 ± 2 hrs under the standard condition Note 1,5		

17. High Temperature Loading

Specified Value	Temperature Compensating (Class1)	Standard	Appearance : No abnormality Capacitance change : Within $\pm 3\%$ or $\pm 0.3\text{pF}$, whichever is larger. Q : $C < 10\text{pF}$: $Q \geq 200 + 10C$ $10 \leq C < 30\text{pF}$: $Q \geq 275 + 2.5C$ $C \geq 30\text{pF}$: $Q \geq 350$ (C: Nominal capacitance) Insulation resistance : $1000 \text{ M}\Omega$ min.
		High Frequency Type	Appearance : No abnormality Capacitance change : Within $\pm 3\%$ or $\pm 0.3\text{pF}$, whichever is larger. Insulation resistance : $1000 \text{ M}\Omega$ min.
	High Permittivity (Class2) Note 1	Appearance : No abnormality Capacitance change : Within $\pm 12.5\%$ Dissipation factor : 5.0% max. Insulation resistance : $50 \text{ M}\Omega \mu\text{F}$ or $1000 \text{ M}\Omega$, whichever is smaller.	
Test Methods and Remarks	Preconditioning : Voltage treatment (Twice the rated voltage shall be applied for 1 hour at 85°C , 105°C or 125°C) Note 1,3,4 (Only High permittivity) Temperature : Maximum operating temperature Duration : $1000 +24/-0$ hrs Applied voltage : Rated voltage $\times 2$ Note 4 Charge/discharge current : 50mA max. Recovery : 24 ± 2 hrs under the standard condition Note 1,5		

Note 1 The figures indicate typical specifications. Please refer to individual specifications in detail.

Note 2 Thermal treatment : Initial value shall be measured after test sample is heat-treated at $150 \pm 0 / -10^\circ\text{C}$ for an hour and kept at room temperature for 24 ± 2 hours.

Note 3 Voltage treatment : Initial value shall be measured after test sample is voltage-treated for an hour at both the temperature and voltage specified in the test conditions, and kept at room temperature for 24 ± 2 hours.

Note 4 150% of rated voltage is applicable to some items. Please refer to their specifications for further information.

Note 5 Standard condition: Temperature: 5 to 35°C , Relative humidity: 45 to 85% RH, Air pressure: 86 to 106kPa When there are questions concerning measurement results, in order to provide correlation data, the test shall be conducted under the following condition.

Temperature: $20 \pm 2^\circ\text{C}$, Relative humidity: 60 to 70% RH, Air pressure: 86 to 106kPa Unless otherwise specified, all the tests are conducted under the "standard condition".

**Low distortion design/Audible/Good bias Multilayer Ceramic Capacitors
for General Electronic Equipment for Consumer**
**Low distortion design/Audible/Good bias Multilayer Ceramic Capacitors
for Medical Devices classified as GHTF Classes A or B (Japan Classes I or II)**

■ RELIABILITY DATA

1. Operating Temperature Range

Specified Value		Specification	Temperature Range
	LD	X5R	-55~+85°C
	SD	-	-55~+125°C

2. Storage Temperature Range

Specified Value		Specification	Temperature Range
	LD	X5R	-55~+85°C
	SD	-	-55~+125°C

3. Rated Voltage

Specified Value	6.3VDC, 10VDC, 16VDC, 25VDC, 35VDC, 50VDC
-----------------	---

4. Dielectric Withstanding Voltage (Between terminals)

Specified Value	No breakdown or damage	
Test Methods and Remarks	Applied voltage	: Rated voltage × 2.5(LD), Rated voltage × 3(SD)
	Duration	: 1 to 5 sec.
	Charge/discharge current	: 50mA max.

5. Insulation Resistance

Specified Value Note 1	10000 MΩ or 500MΩ μF, whichever is smaller	
Test Methods and Remarks	Applied voltage	: Rated voltage
	Duration	: 60±5 sec.
	Charge/discharge current	: 50mA max.

6. Capacitance (Tolerance)

Specified Value	±10% or ±20%	
Test Methods and Remarks	Measuring frequency	: 1kHz±10%
	Measuring voltage	: 1±0.2Vrms
	Bias application	: None

7. Dissipation Factor

Specified Value	10% max (LD), 0.1% max (SD)	
Test Methods and Remarks	Measuring frequency	: 1kHz±10%
	Measuring voltage	: 1±0.2Vrms
	Bias application	: None

► This catalog contains the typical specification only due to the limitation of space. When you consider the purchase of our products, please check our specification.
For details of each product (characteristics graph, reliability information, precautions for use, and so on), see our Web site (<http://www.ty-top.com/>).

8. Temperature Characteristic (Without voltage application)

Specified Value	Specification		Capacitance change	Reference temperature	Temperature Range
	LD	X5R	± 15%	25°C	-55 ~ +85°C
Test Methods and Remarks	Capacitance at each step shall be measured in thermal equilibrium, and the temperature characteristic shall be calculated from the following equation.				
	Step	X5R			
	1	Minimum operating temperature			
	2	25°C			
3	Maximum operating temperature				
$\frac{(C-C_2)}{C_2} \times 100(\%)$			C :Capacitance value in Step1 or Step3 C ₂ :Capacitance value in Step2		

9. Bending Strength

Specified Value	Appearance : No abnormality Capacitance change : Within ± 12.5% (LD), Within ± 5% (SD)
Test Methods and Remarks	Warp : 1mm Speed : 0.5mm/second Duration : 10 seconds Test board : glass epoxy resin substrate Thickness : 1.6mm

(Unit: mm)

Capacitance measurement shall be conducted with the board bent.

10. Adhesive Force of Terminal Electrodes

Specified Value	Terminal electrodes shall be no exfoliation or a sign of exfoliation.
Test Methods and Remarks	Applied force : 5N Duration : 30 ± 5 seconds

11. Vibration

Specified Value	Initial performance shall be satisfied.
Test Methods and Remarks	Preconditioning : Thermal treatment (at 150°C for 1hr) Note2 (Only LD) Frequency range : 10 to 55 Hz Overall amplitude : 1.5 mm Sweeping method : 10 to 55 to 10 Hz for 1 min Two hours each in X, Y, Z directions: 6 hrs in total

12. Solderability

Specified Value	At least 95% of terminal electrode is covered by new solder.		
Test Methods and Remarks		Eutectic solder	Lead-free solder
	Solder type	H60A or H63A	Sn-3.0Ag-0.5Cu
	Solder temperature	230 ± 5°C	245 ± 3°C
	Duration	4 ± 1 sec.	

► This catalog contains the typical specification only due to the limitation of space. When you consider the purchase of our products, please check our specification. For details of each product (characteristics graph, reliability information, precautions for use, and so on), see our Web site (<http://www.ty-top.com/>).

13. Resistance to Soldering Heat

Specified Value	Appearance	: No abnormality																																							
	Capacitance change	: Within $\pm 7.5\%$ (LD), Within $\pm 2.5\%$ (SD)																																							
Specified Value	Dissipation factor	: Initial value																																							
	Insulation resistance	: Initial value																																							
Specified Value	Withstanding voltage (between terminals)	: No abnormality																																							
	Test Methods and Remarks	<table border="1"> <thead> <tr> <th></th> <th colspan="2">LD</th> </tr> <tr> <th></th> <th>1608、2012type</th> <th>3216、3225type</th> </tr> </thead> <tbody> <tr> <td>Preconditioning</td> <td colspan="2">Thermal treatment (at 150°C for 1 hr) Note 2</td> </tr> <tr> <td>Preheating conditions</td> <td>80 to 100°C 2 to 5 min 150 to 200°C 2 to 5 min</td> <td>80 to 100°C 5 to 10 min 150 to 200°C 5 to 10 min</td> </tr> <tr> <td>Solder temp.</td> <td colspan="2">270 \pm 5°C</td> </tr> <tr> <td>Duration</td> <td colspan="2">3 \pm 0.5 sec.</td> </tr> <tr> <td>Measurement shall be conducted</td> <td colspan="2">24 \pm 2hrs under the standard condition Note 5</td> </tr> </tbody> </table> <table border="1"> <thead> <tr> <th></th> <th colspan="2">SD</th> </tr> <tr> <th></th> <th>1005、1608、2012type</th> <th>3216type</th> </tr> </thead> <tbody> <tr> <td>Preheating conditions</td> <td>80 to 100°C 2 to 5 min 150 to 200°C 2 to 5 min</td> <td>80 to 100°C 5 to 10 min 150 to 200°C 5 to 10 min</td> </tr> <tr> <td>Solder temp.</td> <td colspan="2">270 \pm 5°C</td> </tr> <tr> <td>Duration</td> <td colspan="2">3 \pm 0.5 sec.</td> </tr> <tr> <td>Measurement shall be conducted</td> <td colspan="2">24 \pm 2hrs under the standard condition Note 5</td> </tr> </tbody> </table>			LD			1608、2012type	3216、3225type	Preconditioning	Thermal treatment (at 150°C for 1 hr) Note 2		Preheating conditions	80 to 100°C 2 to 5 min 150 to 200°C 2 to 5 min	80 to 100°C 5 to 10 min 150 to 200°C 5 to 10 min	Solder temp.	270 \pm 5°C		Duration	3 \pm 0.5 sec.		Measurement shall be conducted	24 \pm 2hrs under the standard condition Note 5			SD			1005、1608、2012type	3216type	Preheating conditions	80 to 100°C 2 to 5 min 150 to 200°C 2 to 5 min	80 to 100°C 5 to 10 min 150 to 200°C 5 to 10 min	Solder temp.	270 \pm 5°C		Duration	3 \pm 0.5 sec.		Measurement shall be conducted	24 \pm 2hrs under the standard condition Note 5
	LD																																								
	1608、2012type	3216、3225type																																							
Preconditioning	Thermal treatment (at 150°C for 1 hr) Note 2																																								
Preheating conditions	80 to 100°C 2 to 5 min 150 to 200°C 2 to 5 min	80 to 100°C 5 to 10 min 150 to 200°C 5 to 10 min																																							
Solder temp.	270 \pm 5°C																																								
Duration	3 \pm 0.5 sec.																																								
Measurement shall be conducted	24 \pm 2hrs under the standard condition Note 5																																								
	SD																																								
	1005、1608、2012type	3216type																																							
Preheating conditions	80 to 100°C 2 to 5 min 150 to 200°C 2 to 5 min	80 to 100°C 5 to 10 min 150 to 200°C 5 to 10 min																																							
Solder temp.	270 \pm 5°C																																								
Duration	3 \pm 0.5 sec.																																								
Measurement shall be conducted	24 \pm 2hrs under the standard condition Note 5																																								

14. Temperature Cycle (Thermal Shock)

Specified Value	Appearance	: No abnormality																														
	Capacitance change	: Within $\pm 7.5\%$ (LD), Within $\pm 2.5\%$ (SD)																														
Specified Value	Dissipation factor	: Initial value																														
	Insulation resistance	: Initial value																														
Specified Value	Withstanding voltage (between terminals)	: No abnormality																														
	Test Methods and Remarks	<table border="1"> <thead> <tr> <th></th> <th>LD</th> <th>SD</th> </tr> </thead> <tbody> <tr> <td>Preconditioning</td> <td>Thermal treatment (at 150°C for 1 hr) Note 2</td> <td>None</td> </tr> <tr> <td>1 cycle</td> <td colspan="2"> <table border="1"> <thead> <tr> <th>Step</th> <th>temperature (°C)</th> <th>Time (min.)</th> </tr> </thead> <tbody> <tr> <td>1</td> <td>Minimum operating temperature</td> <td>30 \pm 3 min.</td> </tr> <tr> <td>2</td> <td>Normal temperature</td> <td>2 to 3 min.</td> </tr> <tr> <td>3</td> <td>Maximum operating temperature</td> <td>30 \pm 3 min.</td> </tr> <tr> <td>4</td> <td>Normal temperature</td> <td>2 to 3 min.</td> </tr> </tbody> </table> </td> </tr> <tr> <td>Number of cycles</td> <td colspan="2">5 time</td> </tr> <tr> <td>Measurement shall be conducted</td> <td colspan="2">24 \pm 2hrs under the standard condition Note 5</td> </tr> </tbody> </table>			LD	SD	Preconditioning	Thermal treatment (at 150°C for 1 hr) Note 2	None	1 cycle	<table border="1"> <thead> <tr> <th>Step</th> <th>temperature (°C)</th> <th>Time (min.)</th> </tr> </thead> <tbody> <tr> <td>1</td> <td>Minimum operating temperature</td> <td>30 \pm 3 min.</td> </tr> <tr> <td>2</td> <td>Normal temperature</td> <td>2 to 3 min.</td> </tr> <tr> <td>3</td> <td>Maximum operating temperature</td> <td>30 \pm 3 min.</td> </tr> <tr> <td>4</td> <td>Normal temperature</td> <td>2 to 3 min.</td> </tr> </tbody> </table>		Step	temperature (°C)	Time (min.)	1	Minimum operating temperature	30 \pm 3 min.	2	Normal temperature	2 to 3 min.	3	Maximum operating temperature	30 \pm 3 min.	4	Normal temperature	2 to 3 min.	Number of cycles	5 time		Measurement shall be conducted	24 \pm 2hrs under the standard condition Note 5
	LD	SD																														
Preconditioning	Thermal treatment (at 150°C for 1 hr) Note 2	None																														
1 cycle	<table border="1"> <thead> <tr> <th>Step</th> <th>temperature (°C)</th> <th>Time (min.)</th> </tr> </thead> <tbody> <tr> <td>1</td> <td>Minimum operating temperature</td> <td>30 \pm 3 min.</td> </tr> <tr> <td>2</td> <td>Normal temperature</td> <td>2 to 3 min.</td> </tr> <tr> <td>3</td> <td>Maximum operating temperature</td> <td>30 \pm 3 min.</td> </tr> <tr> <td>4</td> <td>Normal temperature</td> <td>2 to 3 min.</td> </tr> </tbody> </table>		Step	temperature (°C)	Time (min.)	1	Minimum operating temperature	30 \pm 3 min.	2	Normal temperature	2 to 3 min.	3	Maximum operating temperature	30 \pm 3 min.	4	Normal temperature	2 to 3 min.															
Step	temperature (°C)	Time (min.)																														
1	Minimum operating temperature	30 \pm 3 min.																														
2	Normal temperature	2 to 3 min.																														
3	Maximum operating temperature	30 \pm 3 min.																														
4	Normal temperature	2 to 3 min.																														
Number of cycles	5 time																															
Measurement shall be conducted	24 \pm 2hrs under the standard condition Note 5																															

15. Humidity (Steady state)

Specified Value Note 1	Appearance	: No abnormality																		
	Capacitance change	: Within $\pm 12.5\%$ (LD), $\pm 5\%$ Within(SD)																		
Specified Value	Dissipation factor	: 20%max(LD), 0.5%max(SD)																		
	Insulation resistance	: 50M Ω μ F or 1000M Ω , whichever is smaller																		
Test Methods and Remarks	<table border="1"> <thead> <tr> <th></th> <th>LD</th> <th>SD</th> </tr> </thead> <tbody> <tr> <td>Preconditioning</td> <td>Thermal treatment (at 150°C for 1 hr) Note 2</td> <td>None</td> </tr> <tr> <td>Temperature</td> <td colspan="2">40 \pm 2°C</td> </tr> <tr> <td>Humidity</td> <td colspan="2">90 to 95% RH</td> </tr> <tr> <td>Duration</td> <td colspan="2">500 +24/-0 hrs</td> </tr> <tr> <td>Measurement shall be conducted</td> <td colspan="2">24 \pm 2hrs under the standard condition Note 5</td> </tr> </tbody> </table>			LD	SD	Preconditioning	Thermal treatment (at 150°C for 1 hr) Note 2	None	Temperature	40 \pm 2°C		Humidity	90 to 95% RH		Duration	500 +24/-0 hrs		Measurement shall be conducted	24 \pm 2hrs under the standard condition Note 5	
	LD	SD																		
Preconditioning	Thermal treatment (at 150°C for 1 hr) Note 2	None																		
Temperature	40 \pm 2°C																			
Humidity	90 to 95% RH																			
Duration	500 +24/-0 hrs																			
Measurement shall be conducted	24 \pm 2hrs under the standard condition Note 5																			

16. Humidity Loading

Specified Value Note 1	Appearance	: No abnormality	
	Capacitance change	: Within $\pm 12.5\%$ (LD), Within $\pm 7.5\%$ (SD)	
	Dissipation factor	: 20%max (LD), 0.5%max (SD)	
	Insulation resistance	: 25M Ω μ F or 500M Ω , whichever is smaller	
Test Methods and Remarks		LD	SD
	Preconditioning	Voltage treatment (Rated voltage are applied for 1 hour at 40 °C) Note 3	
	Temperature	40 \pm 2°C	
	Humidity	90 to 95% RH	
	Duration	500 +24/−0 hrs	
	Applied voltage	Rated voltage	
	Charge/discharge current	50mA max	
	Measurement shall be conducted	24 \pm 2hrs under the standard condition Note 5	

17. High Temperature Loading

Specified Value Note 1	Appearance	: No abnormality	
	Capacitance change	: Within $\pm 12.5\%$ (LD), Within $\pm 3\%$ (SD)	
	Dissipation factor	: 20%max (LD), 0.35%max (SD)	
	Insulation resistance	: 50M Ω μ F or 1000M Ω , whichever is smaller	
Test Methods and Remarks		LD	SD
	Preconditioning	Voltage treatment (Twice the rated voltage shall be applied for 1 hour at 85°C or 125°C) Note 3, Note 4	
	Temperature	Maximum operating temperature	
	Duration	1000 +48/−0 hrs	
	Applied voltage	Rated voltage x 2 Note 4	Rated voltage x 2
	Charge/discharge current	50mA max	
	Measurement shall be conducted	24 \pm 2hrs under the standard condition Note 5	

Note 1 The figures indicate typical specifications. Please refer to individual specifications in detail.

Note 2 Thermal treatment : Initial value shall be measured after test sample is heat-treated at 150 \pm 0/−10°C for an hour and kept at room temperature for 24 \pm 2hours.

Note 3 Voltage treatment : Initial value shall be measured after test sample is voltage-treated for an hour at both the temperature and voltage specified in the test conditions, and kept at room temperature for 24 \pm 2hours.

Note 4 150% of rated voltage is applicable to some items. Please refer to their specifications for further information.

Note 5 Standard condition: Temperature: 5 to 35°C, Relative humidity: 45 to 85 % RH, Air pressure: 86 to 106kPa When there are questions concerning measurement results, in order to provide correlation data, the test shall be conducted under the following condition.

Temperature: 20 \pm 2°C, Relative humidity: 60 to 70 % RH, Air pressure: 86 to 106kPa Unless otherwise specified, all the tests are conducted under the "standard condition".

Medium-High Voltage Multilayer Ceramic Capacitor for General Electronic Equipment for Consumer
Medium-High Voltage Multilayer Ceramic Capacitor
for Medical Devices classified as GHTF Classes A or B (Japan Classes I or II)

■ RELIABILITY DATA

1. Operating Temperature Range		
Specified Value	Temperature Compensating(Class1)	C0G, C0H : -55 to +125°C
	High Permittivity (Class2)	X7R, X7S : -55 to +125°C X5R : -55 to +85°C B : -25 to +85°C SD : -55 to +125°C
2. Storage Temperature Range		
Specified Value	Temperature Compensating(Class1)	C0G, C0H : -55 to +125°C
	High Permittivity (Class2)	X7R, X7S : -55 to +125°C X5R : -55 to +85°C B : -25 to +85°C SD : -55 to +125°C
3. Rated Voltage		
Specified Value	Temperature Compensating(Class1)	100VDC(Code:H)
	High Permittivity (Class2)	100VDC(Code:H), 250VDC(Code:Q), 630VDC(Code:S), 2000VDC(Code:X)
4. Withstanding Voltage (Between terminals)		
Specified Value	No breakdown or damage	
Test Methods and Remarks	Applied voltage : Rated voltage (H) × 2.5, Rated voltage (Q) × 2, Rated voltage (S, X) × 1.2 Duration : 1 to 5sec. Charge/discharge current : 50mA max.	
5. Insulation Resistance		
Specified Value	Temperature Compensating(Class1)	10000 MΩ min.
	High Permittivity (Class2)	100MΩ · μF or 10GΩ, whichever is smaller.
Test Methods and Remarks	Applied voltage : Rated voltage (H, Q), 500V (S, X) Duration : 60 ± 5sec. Charge/discharge current : 50mA max.	
6. Capacitance (Tolerance)		
Specified Value	Temperature Compensating(Class1)	C ≤ 10pF : ±0.5pF C > 10pF : ±5% (C: Nominal capacitance)
	High Permittivity (Class2)	±10%, ±20%
Test Methods and Remarks	Temperature Compensating(Class1)	Measuring frequency : 1MHz ± 10% Measuring voltage : 0.5~5Vrms Bias application : None
	High Permittivity (Class2)	Measuring frequency : 1kHz ± 10%, 1MHz ± 10% (SD: 1608type(H), 2012type(Q)) Measuring voltage : 1 ± 0.2Vrms Bias application : None

► This catalog contains the typical specification only due to the limitation of space. When you consider the purchase of our products, please check our specification.
 For details of each product (characteristics graph, reliability information, precautions for use, and so on), see our Web site (<http://www.ty-top.com/>).

7. Q or Dissipation Factor

Specified Value	Temperature Compensating(Class1)	C < 30pF : Q ≥ 400 + 20C C ≥ 30pF : Q ≥ 1000 (C: Nominal capacitance)
	High Permittivity (Class2)	3.5%max(H: 1608type min), 2.5%max(H: 1005type,Q, S, X), 0.1type max (SD)
Test Methods and Remarks	Temperature Compensating(Class1)	Measuring frequency : 1MHz ± 10% Measuring voltage : 0.5 ~ 5Vrms Bias application : None
	High Permittivity (Class2)	Measuring frequency : 1kHz ± 10%, 1MHz ± 10% (SD:1608type(H), 2012type(Q)) Measuring voltage : 1 ± 0.2Vrms Bias application : None

8. Temperature Characteristic of Capacitance

Specified Value	Temperature Compensating(Class1)	C0G : 0 ± 30ppm/°C (-55 to +125°C) C0H : 0 ± 60ppm/°C (-55 ~ +125°C)											
	High Permittivity (Class2)	B : ± 10% (-25 to +85°C) X5R : ± 15% (-55 to +85°C) X7R : ± 15% (-55 to +125°C) X7S : ± 22% (-55 to +125°C)											
Test Methods and Remarks	<p>Class 1 Capacitance at 20°C and 85°C shall be measured in thermal equilibrium, and the temperature characteristic shall be calculated from the following equation.</p> $\frac{(C_{85} - C_{20})}{C_{20} \times \Delta T} \times 10^6 \text{ (ppm/°C)} \quad \Delta T = 65$												
	<p>Class 2 Capacitance at each step shall be measured in thermal equilibrium, and the temperature characteristic shall be calculated from the following equation.</p> <table border="1" style="margin-left: 20px;"> <thead> <tr> <th>Step</th> <th>B</th> <th>X5R, X7R, X7S</th> </tr> </thead> <tbody> <tr> <td>1</td> <td colspan="2">Minimum operating temperature</td> </tr> <tr> <td>2</td> <td>20°C</td> <td>25°C</td> </tr> <tr> <td>3</td> <td colspan="2">Maximum operating temperature</td> </tr> </tbody> </table> $\frac{(C - C_2)}{C_2} \times 100 \text{ (%)}$ <p>C : Capacitance value in Step 1 or Step 3 C2 : Capacitance value in Step 2</p>		Step	B	X5R, X7R, X7S	1	Minimum operating temperature		2	20°C	25°C	3	Maximum operating temperature
Step	B	X5R, X7R, X7S											
1	Minimum operating temperature												
2	20°C	25°C											
3	Maximum operating temperature												

9. Deflection

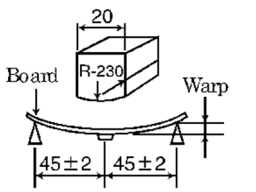
Specified Value	Temperature Compensating(Class1)	Appearance : No abnormality Capacitance change : Within ± 5% or ± 0.5 pF, whichever is larger.
	High Permittivity (Class2)	Appearance : No abnormality Capacitance change : ± 10%, ± 5%, (SD)
Test Methods and Remarks	<p>Warp : 1mm Duration : 10sec. Test board : Glass epoxy-resin substrate Thickness : 1.6mm</p>	 <p>(Unit: mm)</p>
	Capacitance measurement shall be conducted with the board bent.	

10. Adhesive Strength of Terminal Electrodes

Specified Value	Temperature Compensating(Class1)	No terminal separation or its indication.
	High Permittivity (Class2)	
Test Methods and Remarks	Applied force : 5N	
	Duration : 30 ± 5sec.	

14. Temperature Cycle (Thermal Shock)

Specified Value	Temperature Compensating(Class1)	Appearance : No abnormality Capacitance change : Within $\pm 2.5\%$ or $\pm 0.25\text{pF}$, whichever is larger. Q : Initial value Insulation resistance : Initial value Withstanding voltage (between terminals) : No abnormality	
	High Permittivity (Class2)	Appearance : No abnormality Capacitance change : Within $\pm 7.5\%$ (H: 1005type), $\pm 15\%$ (H: 1608type min) $\pm 10\%$ (Q, S, X), $\pm 2.5\%$ (SD) Dissipation facto : Initial value Insulation resistance : Initial value Withstanding voltage (between terminals) : No abnormality	
Test Methods and Remarks	Class 1		
	Class 2		
	Preconditioning	None	
	Thermal treatment (at 150°C for 1 hr) Note 1		
	1 cycle	Step	Temperature (°C)
		1	Minimum operating temperature
2		Normal temperature	
3		Maximum operating temperature	
4	Normal temperature		
Number of cycles	5 times		
Recovery	24 \pm 2 hrs (Standard condition) Note 3		

15. Humidity (Steady state)

Specified Value	Temperature Compensating(Class1)	Appearance : No abnormality Capacitance change : Within $\pm 5\%$ or $\pm 0.5\text{pF}$, whichever is larger. Q : $C < 10\text{pF} : Q \geq 200 + 10C$ $10 \leq C < 30\text{pF} : Q \geq 275 + 2.5C$ $C \geq 30\text{pF} : Q \geq 350$ (C:Nominal capacitance) Insulation resistance : 1000 M Ω min.
	High Permittivity (Class2)	Appearance : No abnormality Capacitance change : $\pm 12.5\%$ max(1005type), $\pm 15\%$ max(1608type min), $\pm 5\%$ max(SD) Dissipation factor : 5%max(H: 1005type,Q, S, X), 7%max(H: 1608type min), 0.5%max(SD). Insulation resistance : 25M Ω μ F or 1000M Ω , whichever is smaller.
Test Methods and Remarks	Preconditioning	: Thermal treatment(at 150°C for 1hr) Note1 (Only High permittivity)
	Temperature	: 40 \pm 2°C
	Humidity	: 90 to 95%RH
	Duration	: 500 +24/ -0 hrs
	Recovery	: 24 \pm 2hrs under the standard condition Note3

16. Humidity Loading

Specified Value	Temperature Compensating(Class1)	Appearance : No abnormality Capacitance change : Within $\pm 7.5\%$ or $\pm 0.75\text{pF}$, whichever is larger Q : $C < 30\text{pF} : Q \geq 100 + 10C/3$ $C \geq 30\text{pF} : Q \geq 200$ (C:Nominal capacitance) Insulation resistance : 500 M Ω min.
	High Permittivity (Class2)	Appearance : No abnormality Capacitance change : $\pm 12.5\%$ max(1005type), $\pm 15\%$ max(1608type min), $\pm 7.5\%$ max(SD) Dissipation factor : 5%max(H: 1005type,Q, S, X), 7%max(H: 1608type min), 0.5%max(SD) Insulation resistance : 10M Ω μ F or 500M Ω , whichever is smaller.
Test Methods and Remarks	Preconditioning	: Voltage treatment(Rated voltage are applied for 1 hour at 40°C)Note 2 (Only High permittivity)
	Temperature	: 40 \pm 2°C
	Humidity	: 90 to 95%RH
	Duration	: 500 +24/ -0 hrs
	Applied voltage	: Rated voltage
	Charge/discharge current	: 50mA max.
	Recovery	: 24 \pm 2hrs under the standard condition Note3

► This catalog contains the typical specification only due to the limitation of space. When you consider the purchase of our products, please check our specification. For details of each product (characteristics graph, reliability information, precautions for use, and so on), see our Web site (<http://www.ty-top.com/>).

17. High Temperature Loading

Specified Value	Temperature Compensating(Class1)	Appearance : No abnormality Capacitance change : Within $\pm 3\%$ or $\pm 0.3\text{pF}$, whichever is larger Q : $C < 10\text{pF}$: $Q \geq 200 + 10C$ $10 \leq C < 30\text{pF}$: $Q \geq 275 + 2.5C$ $C \geq 30\text{pF}$: $Q \geq 350$ (C:Nominal capacitance) Insulation resistance : $1000 \text{ M}\Omega$ min.
	High Permittivity (Class2)	Appearance : No abnormality Capacitance change : $\pm 12.5\% \text{max}(1005\text{type})$, $\pm 15\% \text{max}(1608\text{type min})$, $\pm 3\% \text{max}(SD)$ Dissipation factor : $5\% \text{max}(H: 1005\text{type}, Q, S, X)$, $7\% \text{max}(H: 1608\text{type min})$, $0.35\% \text{max}(SD)$ Insulation resistance : $50 \text{ M}\Omega \mu\text{F}$ or $1000 \text{ M}\Omega$, whichever is smaller.
Test Methods and Remarks	Preconditioning : Voltage treatment(Twice the rated voltage shall be applied for 1 hour at 85°C or 125°C) Note 2 (Only High permittivity) Temperature : Maximum operating temperature Duration : $1000 + 24 / - 0$ hrs Applied voltage : Rated voltage(H) $\times 2$, Rated voltage(Q) $\times 1.5$, Rated voltage $\times 1.2$ (S, X) $\times 1.2$ Charge/discharge current : 50mA max. Recovery : 24 ± 2 hrs under the standard condition Note3	

Note1 Thermal treatment : Initial value shall be measured after test sample is heat-treated at $150 \pm 0 / - 10^\circ\text{C}$ for an hour and kept at room temperature for 24 ± 2 hours.

Note2 Voltage treatment : Initial value shall be measured after test sample is voltage-treated for an hour at both the temperature and voltage specified in the test conditions, and kept at room temperature for 24 ± 2 hours.

Note3 Standard condition : Temperature: 5 to 35°C , Relative humidity: 45 to 85% RH, Air pressure: 86 to 106kPa
 When there are questions concerning measurement results, in order to provide correlation data, the test shall be conducted under the following condition.
 Temperature: $20 \pm 2^\circ\text{C}$, Relative humidity: 60 to 70% RH, Air pressure: 86 to 106kPa
 Unless otherwise specified, all the tests are conducted under the "standard condition".

Multilayer Ceramic Capacitors

PRECAUTIONS

1. Circuit Design

- Precautions**
- ◆ Verification of operating environment, electrical rating and performance
 1. A malfunction of equipment in fields such as medical, aerospace, nuclear control, etc. may cause serious harm to human life or have severe social ramifications. Therefore, any capacitors to be used in such equipment may require higher safety and reliability, and shall be clearly differentiated from them used in general purpose applications.
 - ◆ Operating Voltage (Verification of Rated voltage)
 1. The operating voltage for capacitors must always be their rated voltage or less.
 - If an AC voltage is loaded on a DC voltage, the sum of the two peak voltages shall be the rated voltage or less.
 - For a circuit where an AC or a pulse voltage may be used, the sum of their peak voltages shall also be the rated voltage or less.
 2. Even if an applied voltage is the rated voltage or less reliability of capacitors may be deteriorated in case that either a high frequency AC voltage or a pulse voltage having rapid rise time is used in a circuit.

2. PCB Design

- Precautions**
- ◆ Pattern configurations (Design of Land-patterns)
 1. When capacitors are mounted on PCBs, the amount of solder used (size of fillet) can directly affect the capacitor performance. Therefore, the following items must be carefully considered in the design of land patterns:
 - (1) Excessive solder applied can cause mechanical stresses which lead to chip breaking or cracking. Therefore, please consider appropriate land-patterns for proper amount of solder.
 - (2) When more than one component are jointly soldered onto the same land, each component's soldering point shall be separated by solder-resist.
 - ◆ Pattern configurations (Capacitor layout on PCBs)

After capacitors are mounted on boards, they can be subjected to mechanical stresses in subsequent manufacturing processes (PCB cutting, board inspection, mounting of additional parts, assembly into the chassis, wave soldering of the boards, etc.). For this reason, land pattern configurations and positions of capacitors shall be carefully considered to minimize stresses.

Technical considerations

- ◆ Pattern configurations (Design of Land-patterns)

The following diagrams and tables show some examples of recommended land patterns to prevent excessive solder amounts.

(1) Recommended land dimensions for typical chip capacitors

 - Multilayer Ceramic Capacitors : Recommended land dimensions (unit: mm)

Wave-soldering

Type	1608	2012	3216	3225	
Size	L	1.6	2.0	3.2	3.2
	W	0.8	1.25	1.6	2.5
A	0.8 to 1.0	1.0 to 1.4	1.8 to 2.5	1.8 to 2.5	
B	0.5 to 0.8	0.8 to 1.5	0.8 to 1.7	0.8 to 1.7	
C	0.6 to 0.8	0.9 to 1.2	1.2 to 1.6	1.8 to 2.5	

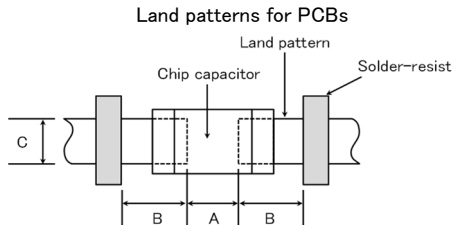

Reflow-soldering

Type	0201	0402	0603	1005	1608	2012	3216	3225	4532
Size	L	0.25	0.4	0.6	1.0	1.6	2.0	3.2	4.5
	W	0.125	0.2	0.3	0.5	0.8	1.25	1.6	3.2
A	0.095~0.135	0.15~0.25	0.20~0.30	0.45~0.55	0.6~0.8	0.8~1.2	1.8~2.5	1.8~2.5	2.5~3.5
B	0.085~0.125	0.10~0.20	0.20~0.30	0.40~0.50	0.6~0.8	0.8~1.2	1.0~1.5	1.0~1.5	1.5~1.8
C	0.110~0.150	0.15~0.30	0.25~0.40	0.45~0.55	0.6~0.8	0.9~1.6	1.2~2.0	1.8~3.2	2.3~3.5

Note: Recommended land size might be different according to the allowance of the size of the product.

 - LWDC: Recommended land dimensions for reflow-soldering (unit: mm)

Type	0510	0816	1220	
Size	L	0.52	0.8	1.25
	W	1.0	1.6	2.0
A	0.18~0.22	0.25~0.3	0.5~0.7	
B	0.2~0.25	0.3~0.4	0.4~0.5	
C	0.9~1.1	1.5~1.7	1.9~2.1	

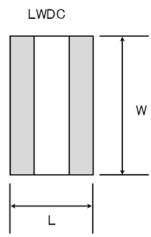

▶ This catalog contains the typical specification only due to the limitation of space. When you consider the purchase of our products, please check our specification. For details of each product (characteristics graph, reliability information, precautions for use, and so on), see our Web site (<http://www.ty-top.com/>).

(2) Examples of good and bad solder application

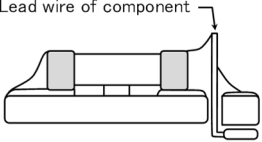
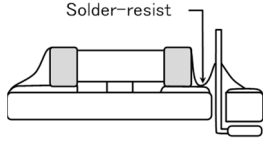
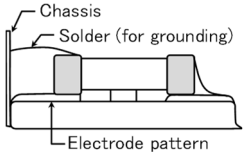
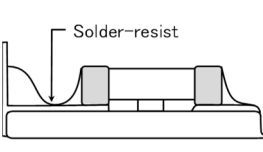
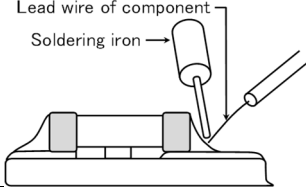
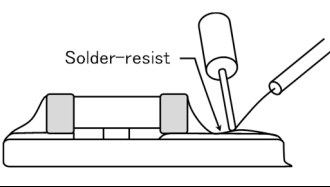
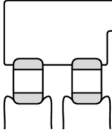
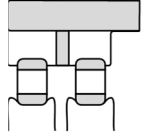
Item	Not recommended	Recommended
Mixed mounting of SMD and leaded components		
Component placement close to the chassis		
Hand-soldering of leaded components near mounted components		
Horizontal component placement		

◆ Pattern configurations (Capacitor layout on PCBs)

1-1. The following is examples of good and bad capacitor layouts ; capacitors shall be located to minimize any possible mechanical stresses from board warp or deflection.

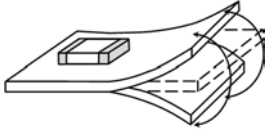
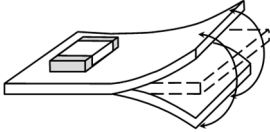
Items	Not recommended	Recommended
Deflection of board		 Place the product at a right angle to the direction of the anticipated mechanical stress.

1-2. The amount of mechanical stresses given will vary depending on capacitor layout. Please refer to diagram below.

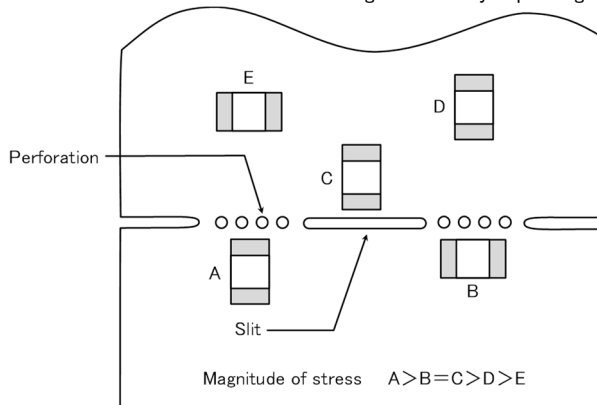

1-3. When PCB is split, the amount of mechanical stress on the capacitors can vary according to the method used. The following methods are listed in order from least stressful to most stressful: push-back, slit, V-grooving, and perforation. Thus, please consider the PCB, split methods as well as chip location.

3. Mounting

Precautions

◆ Adjustment of mounting machine

- When capacitors are mounted on PCB, excessive impact load shall not be imposed on them.
- Maintenance and inspection of mounting machines shall be conducted periodically.

◆ Selection of Adhesives

- When chips are attached on PCBs with adhesives prior to soldering, it may cause capacitor characteristics degradation unless the following factors are appropriately checked : size of land patterns, type of adhesive, amount applied, hardening temperature and hardening period. Therefore, please contact us for further information.

◆ Adjustment of mounting machine

1. When the bottom dead center of a pick-up nozzle is too low, excessive force is imposed on capacitors and causes damages. To avoid this, the following points shall be considerable.
 - (1) The bottom dead center of the pick-up nozzle shall be adjusted to the surface level of PCB without the board deflection.
 - (2) The pressure of nozzle shall be adjusted between 1 and 3 N static loads.
 - (3) To reduce the amount of deflection of the board caused by impact of the pick-up nozzle, supporting pins or back-up pins shall be used on the other side of the PCB. The following diagrams show some typical examples of good and bad pick-up nozzle placement:

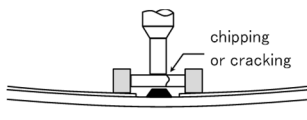
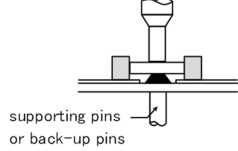
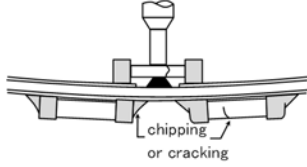
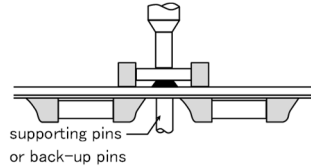
Item	Improper method	Proper method
Single-sided mounting		
Double-sided mounting		

Technical considerations

2. As the alignment pin is worn out, adjustment of the nozzle height can cause chipping or cracking of capacitors because of mechanical impact on the capacitors. To avoid this, the monitoring of the width between the alignment pins in the stopped position, maintenance, check and replacement of the pin shall be conducted periodically.

◆ Selection of Adhesives

Some adhesives may cause IR deterioration. The different shrinkage percentage of between the adhesive and the capacitors may result in stresses on the capacitors and lead to cracking. Moreover, too little or too much adhesive applied to the board may adversely affect components. Therefore, the following precautions shall be noted in the application of adhesives.

- (1) Required adhesive characteristics
 - a. The adhesive shall be strong enough to hold parts on the board during the mounting & solder process.
 - b. The adhesive shall have sufficient strength at high temperatures.
 - c. The adhesive shall have good coating and thickness consistency.
 - d. The adhesive shall be used during its prescribed shelf life.
 - e. The adhesive shall harden rapidly.
 - f. The adhesive shall have corrosion resistance.
 - g. The adhesive shall have excellent insulation characteristics.
 - h. The adhesive shall have no emission of toxic gasses and no effect on the human body.
- (2) The recommended amount of adhesives is as follows:

[Recommended condition]

Figure	2012/3216 case sizes as examples
a	0.3mm min
b	100 to 120 μm
c	Adhesives shall not contact land

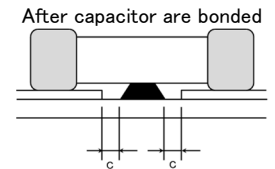
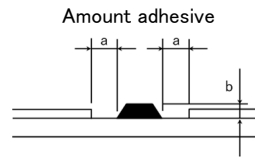

4. Soldering

◆ Selection of Flux

- Since flux may have a significant effect on the performance of capacitors, it is necessary to verify the following conditions prior to use;
- (1) Flux used shall be less than or equal to 0.1 wt% (in Cl equivalent) of halogenated content. Flux having a strong acidity content shall not be applied.
 - (2) When shall capacitors are soldered on boards, the amount of flux applied shall be controlled at the optimum level.
 - (3) When water-soluble flux is used, special care shall be taken to properly clean the boards.

Precautions

◆ Soldering

Temperature, time, amount of solder, etc. shall be set in accordance with their recommended conditions. Sn-Zn solder paste can adversely affect MLCC reliability. Please contact us prior to usage of Sn-Zn solder.

Technical considerations

◆ Selection of Flux

- 1-1. When too much halogenated substance (Chlorine, etc.) content is used to activate flux, or highly acidic flux is used, it may lead to corrosion of terminal electrodes or degradation of insulation resistance on the surfaces of the capacitors.
- 1-2. Flux is used to increase solderability in wave soldering. However if too much flux is applied, a large amount of flux gas may be emitted and may adversely affect the solderability. To minimize the amount of flux applied, it is recommended to use a flux-bubbling system.
- 1-3. Since the residue of water-soluble flux is easily dissolved in moisture in the air, the residues on the surfaces of capacitors in high humidity conditions may cause a degradation of insulation resistance and reliability of the capacitors. Therefore, the cleaning methods

▶ This catalog contains the typical specification only due to the limitation of space. When you consider the purchase of our products, please check our specification. For details of each product (characteristics graph, reliability information, precautions for use, and so on), see our Web site (<http://www.ty-top.com/>).

and the capability of the machines used shall also be considered carefully when water-soluble flux is used.

◆Soldering

- Ceramic chip capacitors are susceptible to thermal shock when exposed to rapid or concentrated heating or rapid cooling.
- Therefore, the soldering must be conducted with great care so as to prevent malfunction of the components due to excessive thermal shock.
- Preheating : Capacitors shall be preheated sufficiently, and the temperature difference between the capacitors and solder shall be within 130°C.
- Cooling : The temperature difference between the capacitors and cleaning process shall not be greater than 100°C.

[Reflow soldering]

【Recommended conditions for eutectic soldering】

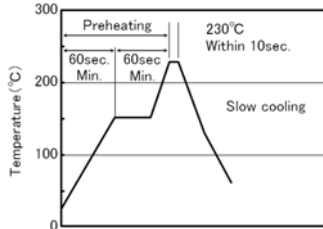

【Recommended condition for Pb-free soldering】

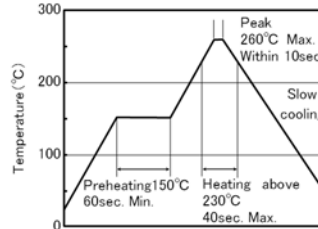

Caution

- ①The ideal condition is to have solder mass (fillet) controlled to 1/2 to 1/3 of the thickness of a capacitor.
- ②Because excessive dwell times can adversely affect solderability, soldering duration shall be kept as close to recommended times as possible. soldering for 2 times.

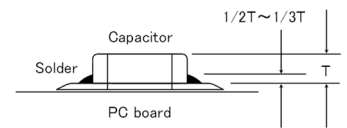

[Wave soldering]

【Recommended conditions for eutectic soldering】

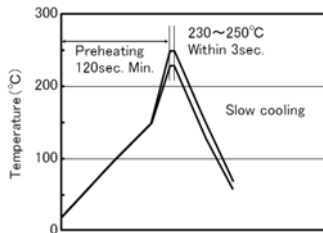

【Recommended condition for Pb-free soldering】

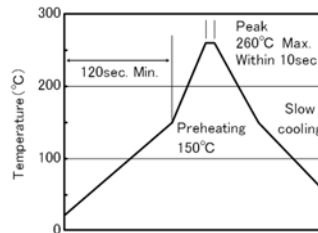

Caution

- ①Wave soldering must not be applied to capacitors designated as for reflow soldering only. soldering for 1 times.

[Hand soldering]

【Recommended conditions for eutectic soldering】

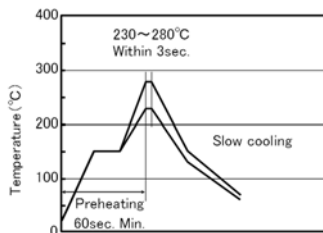

【Recommended condition for Pb-free soldering】

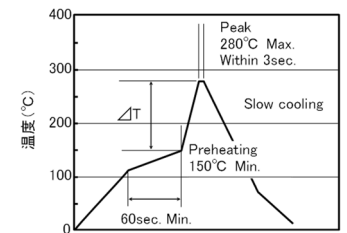
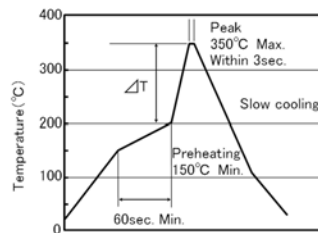

	ΔT
3216type or less	$\Delta T \leq 150^{\circ}\text{C}$

	ΔT
3225type or more	$\Delta T \leq 130^{\circ}\text{C}$

Caution

- ①Use a 50W soldering iron with a maximum tip diameter of 1.0 mm.
- ②The soldering iron shall not directly touch capacitors. soldering for 1 times.

▶ This catalog contains the typical specification only due to the limitation of space. When you consider the purchase of our products, please check our specification. For details of each product (characteristics graph, reliability information, precautions for use, and so on), see our Web site (<http://www.ty-top.com/>).

5. Cleaning	
Precautions	<p>◆Cleaning conditions</p> <ol style="list-style-type: none"> When PCBs are cleaned after capacitors mounting, please select the appropriate cleaning solution in accordance with the intended use of the cleaning. (e.g. to remove soldering flux or other materials from the production process.) Cleaning condition shall be determined after it is verified by using actual cleaning machine that the cleaning process does not affect capacitor's characteristics.
Technical considerations	<ol style="list-style-type: none"> The use of inappropriate cleaning solutions can cause foreign substances such as flux residue to adhere to capacitors or deteriorate their outer coating, resulting in a degradation of the capacitor's electrical properties (especially insulation resistance). Inappropriate cleaning conditions (insufficient or excessive cleaning) may adversely affect the performance of the capacitors. In the case of ultrasonic cleaning, too much power output can cause excessive vibration of PCBs which may lead to the cracking of capacitors or the soldered portion, or decrease the terminal electrodes' strength. Therefore, the following conditions shall be carefully checked: Ultrasonic output : 20 W/l or less Ultrasonic frequency : 40 kHz or less Ultrasonic washing period : 5 min. or less

6. Resin coating and mold	
Precautions	<ol style="list-style-type: none"> With some type of resins, decomposition gas or chemical reaction vapor may remain inside the resin during the hardening period or while left under normal storage conditions resulting in the deterioration of the capacitor's performance. When a resin's hardening temperature is higher than capacitor's operating temperature, the stresses generated by the excessive heat may lead to damage or destruction of capacitors. The use of such resins, molding materials etc. is not recommended.

7. Handling	
Precautions	<p>◆Splitting of PCB</p> <ol style="list-style-type: none"> When PCBs are split after components mounting, care shall be taken so as not to give any stresses of deflection or twisting to the board. Board separation shall not be done manually, but by using the appropriate devices. <p>◆Mechanical considerations</p> <p>Be careful not to subject capacitors to excessive mechanical shocks.</p> <ol style="list-style-type: none"> If ceramic capacitors are dropped onto a floor or a hard surface, they shall not be used. Please be careful that the mounted components do not come in contact with or bump against other boards or components.

8. Storage conditions	
Precautions	<p>◆Storage</p> <ol style="list-style-type: none"> To maintain the solderability of terminal electrodes and to keep packaging materials in good condition, care must be taken to control temperature and humidity in the storage area. Humidity should especially be kept as low as possible. <ul style="list-style-type: none"> Recommended conditions Ambient temperature : Below 30°C Humidity : Below 70% RH The ambient temperature must be kept below 40°C. Even under ideal storage conditions, solderability of capacitor is deteriorated as time passes, so capacitors shall be used within 6 months from the time of delivery. <ul style="list-style-type: none"> Ceramic chip capacitors shall be kept where no chlorine or sulfur exists in the air. The capacitance values of high dielectric constant capacitors will gradually decrease with the passage of time, so care shall be taken to design circuits. Even if capacitance value decreases as time passes, it will get back to the initial value by a heat treatment at 150°C for 1hour.
Technical considerations	<p>If capacitors are stored in a high temperature and humidity environment, it might rapidly cause poor solderability due to terminal oxidation and quality loss of taping/packaging materials. For this reason, capacitors shall be used within 6 months from the time of delivery. If exceeding the above period, please check solderability before using the capacitors.</p>

※RCR-2335B (Safety Application Guide for fixed ceramic capacitors for use in electronic equipment) is published by JEITA.

Please check the guide regarding precautions for deflection test, soldering by spot heat, and so on.