

Notice for TAIYO YUDEN products

Please read this notice before using the TAIYO YUDEN products.

⚠️ REMINDERS

■ Product Information in this Catalog

Product information in this catalog is as of October 2019. All of the contents specified herein and production status of the products listed in this catalog are subject to change without notice due to technical improvement of our products, etc. Therefore, please check for the latest information carefully before practical application or use of our products.

Please note that TAIYO YUDEN shall not be in any way responsible for any damages and defects in products or equipment incorporating our products, which are caused under the conditions other than those specified in this catalog or individual product specification sheets.

■ Approval of Product Specifications

Please contact TAIYO YUDEN for further details of product specifications as the individual product specification sheets are available. When using our products, please be sure to approve our product specifications or make a written agreement on the product specification with TAIYO YUDEN in advance.

■ Pre-Evaluation in the Actual Equipment and Conditions

Please conduct validation and verification of our products in actual conditions of mounting and operating environment before using our products.

■ Limited Application

1. Equipment Intended for Use

The products listed in this catalog are intended for general-purpose and standard use in general electronic equipment (e.g., AV equipment, OA equipment, home electric appliances, office equipment, information and communication equipment including, without limitation, mobile phone, and PC) and other equipment specified in this catalog or the individual product specification sheets.

TAIYO YUDEN has the line-up of the products intended for use in automotive electronic equipment, telecommunications infrastructure and industrial equipment, or medical devices classified as GHTF Classes A to C (Japan Classes I to III). Therefore, when using our products for these equipment, please check available applications specified in this catalog or the individual product specification sheets and use the corresponding products.

2. Equipment Requiring Inquiry

Please be sure to contact TAIYO YUDEN for further information before using the products listed in this catalog for the following equipment (excluding intended equipment as specified in this catalog or the individual product specification sheets) which may cause loss of human life, bodily injury, serious property damage and/or serious public impact due to a failure or defect of the products and/or malfunction attributed thereto.

- (1) Transportation equipment (automotive powertrain control system, train control system, and ship control system, etc.)
- (2) Traffic signal equipment
- (3) Disaster prevention equipment, crime prevention equipment
- (4) Medical devices classified as GHTF Class C (Japan Class III)
- (5) Highly public information network equipment, data-processing equipment (telephone exchange, and base station, etc.)
- (6) Any other equipment requiring high levels of quality and/or reliability equal to the equipment listed above

3. Equipment Prohibited for Use

Please do not incorporate our products into the following equipment requiring extremely high levels of safety and/or reliability.

- (1) Aerospace equipment (artificial satellite, rocket, etc.)
- (2) Aviation equipment *¹
- (3) Medical devices classified as GHTF Class D (Japan Class IV), implantable medical devices *²

- (4) Power generation control equipment (nuclear power, hydroelectric power, thermal power plant control system, etc.)
- (5) Undersea equipment (submarine repeating equipment, underwater work equipment, etc.)
- (6) Military equipment
- (7) Any other equipment requiring extremely high levels of safety and/or reliability equal to the equipment listed above

*Notes:

1. There is a possibility that our products can be used only for aviation equipment that does not directly affect the safe operation of aircraft (e.g., in-flight entertainment, cabin light, electric seat, cooking equipment) if such use meets requirements specified separately by TAIYO YUDEN. Please be sure to contact TAIYO YUDEN for further information before using our products for such aviation equipment.
2. Implantable medical devices contain not only internal unit which is implanted in a body, but also external unit which is connected to the internal unit.

4. Limitation of Liability

Please note that unless you obtain prior written consent of TAIYO YUDEN, TAIYO YUDEN shall not be in any way responsible for any damages incurred by you or third parties arising from use of the products listed in this catalog for any equipment that is not intended for use by TAIYO YUDEN, or any equipment requiring inquiry to TAIYO YUDEN or prohibited for use by TAIYO YUDEN as described above.

■ Safety Design

When using our products for high safety and/or reliability-required equipment or circuits, please fully perform safety and/or reliability evaluation. In addition, please install (i) systems equipped with a protection circuit and a protection device and/or (ii) systems equipped with a redundant circuit or other system to prevent an unsafe status in the event of a single fault for a failsafe design to ensure safety.

■ Intellectual Property Rights

Information contained in this catalog is intended to convey examples of typical performances and/or applications of our products and is not intended to make any warranty with respect to the intellectual property rights or any other related rights of TAIYO YUDEN or any third parties nor grant any license under such rights.

■ Limited Warranty

Please note that the scope of warranty for our products is limited to the delivered our products themselves and TAIYO YUDEN shall not be in any way responsible for any damages resulting from a failure or defect in our products. Notwithstanding the foregoing, if there is a written agreement (e.g., supply and purchase agreement, quality assurance agreement) signed by TAIYO YUDEN and your company, TAIYO YUDEN will warrant our products in accordance with such agreement.

■ TAIYO YUDEN's Official Sales Channel

The contents of this catalog are applicable to our products which are purchased from our sales offices or authorized distributors (hereinafter "TAIYO YUDEN's official sales channel"). Please note that the contents of this catalog are not applicable to our products purchased from any seller other than TAIYO YUDEN's official sales channel.

■ Caution for Export

Some of our products listed in this catalog may require specific procedures for export according to "U.S. Export Administration Regulations", "Foreign Exchange and Foreign Trade Control Law" of Japan, and other applicable regulations. Should you have any questions on this matter, please contact our sales staff.

MULTILAYER CHIP INDUCTORS FOR HIGH FREQUENCY APPLICATIONS(HK SERIES)

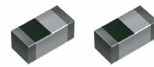

WAVE* REFLOW
*Except for HK0603, HK1005

■ PARTS NUMBER

* Operating Temp.: -55~+125°C (HK1608/2125: -40~+85°C)

H	K	△	0	6	0	3	△	1	0	N	J	-	T
①			②					③			④		⑤

△=Blank space

①Series name

Code	Series name
HK△	Multilayer chip inductor for high frequency applications

②Dimensions (L × W)

Code	Type (inch)	Dimensions (L × W) [mm]
0603	0603 (0201)	0.6 × 0.3
1005	1005 (0402)	1.0 × 0.5
1608	1608 (0603)	1.6 × 0.8
2125	2125 (0805)	2.0 × 1.2

③Nominal inductance

Code (example)	Nominal inductance [nH]
3N9	3.9
10N	10.0
R10	100
R12	120

※R=Decimal point

※N=0.0(nH type)

④Inductance tolerance

Code	Inductance tolerance
J	±5%
S	±0.3nH

⑤Packaging

Code	Packaging
-T	Taping

■ STANDARD EXTERNAL DIMENSIONS / STANDARD QUANTITY

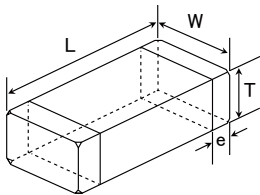

Type	L	W	T	e	Standard quantity [pcs]	
					Paper tape	Embossed tape
HK 0603 (0201)	0.6±0.03 (0.024±0.001)	0.3±0.03 (0.012±0.001)	0.3±0.03 (0.012±0.001)	0.15±0.05 (0.006±0.002)	15000	—
HK 1005 (0402)	1.0±0.05 (0.039±0.002)	0.5±0.05 (0.020±0.002)	0.5±0.05 (0.020±0.002)	0.25±0.10 (0.010±0.004)	10000	—
HK 1608 (0603)	1.6±0.15 (0.063±0.006)	0.8±0.15 (0.031±0.006)	0.8±0.15 (0.031±0.006)	0.3±0.2 (0.012±0.008)	4000	—
HK 2125 (0805)	2.0+0.3/-0.1 (0.079+0.012/-0.004)	1.25±0.2 (0.049±0.008)	0.85±0.2 (0.033±0.008)	0.5±0.3 (0.020±0.012)	—	4000
	2.0+0.3/-0.1 (0.079+0.012/-0.004)	1.25±0.2 (0.049±0.008)	1.0+0.2/-0.3 (0.039+0.008/-0.012)	0.5±0.3 (0.020±0.012)	—	3000

Unit : mm (inch)

► This catalog contains the typical specification only due to the limitation of space. When you consider the purchase of our products, please check our product specification sheets. For details of each product (characteristics graph, reliability information, precautions for use, and so on), see our website (<http://www.ty-top.com/>).

PARTS NUMBER

●HK 0603

Parts number	EHS	Nominal inductance [nH]	Inductance tolerance ※)	Q (min.)	LQ Measuring frequency [MHz]	Q (Typical) frequency [MHz]					Self-resonant frequency [MHz]		DC Resistance [Ω]		Rated current [mA] (max.)	Thickness [mm]
						100	300	500	800	1000	(min.)	(typ.)	(max.)	(typ.)		
HK 0603 1N0□-T	RoHS	1.0	±0.3nH	4	100	6	12	17	22	27	10000	> 13000	0.11	0.088	470	0.30 ±0.03
HK 0603 1N2□-T	RoHS	1.2	±0.3nH	4	100	6	12	16	21	25	10000	> 13000	0.12	0.089	450	0.30 ±0.03
HK 0603 1N5□-T	RoHS	1.5	±0.3nH	4	100	6	12	15	20	23	10000	> 13000	0.13	0.11	430	0.30 ±0.03
HK 0603 1N8□-T	RoHS	1.8	±0.3nH	4	100	6	12	15	20	23	10000	> 13000	0.16	0.12	390	0.30 ±0.03
HK 0603 2N0□-T	RoHS	2.0	±0.3nH	4	100	6	12	15	20	22	10000	> 13000	0.17	0.13	380	0.30 ±0.03
HK 0603 2N2□-T	RoHS	2.2	±0.3nH	4	100	6	12	15	20	22	8800	12500	0.19	0.14	360	0.30 ±0.03
HK 0603 2N4□-T	RoHS	2.4	±0.3nH	4	100	6	12	15	20	22	8300	11700	0.20	0.15	350	0.30 ±0.03
HK 0603 2N7□-T	RoHS	2.7	±0.3nH	5	100	7	12	15	20	22	7700	11000	0.21	0.16	340	0.30 ±0.03
HK 0603 3N0□-T	RoHS	3.0	±0.3nH	5	100	7	12	15	20	22	7200	11000	0.22	0.18	330	0.30 ±0.03
HK 0603 3N3□-T	RoHS	3.3	±0.3nH	5	100	7	12	15	20	22	6700	9600	0.23	0.19	320	0.30 ±0.03
HK 0603 3N6□-T	RoHS	3.6	±0.3nH	5	100	7	12	15	20	22	6400	9100	0.25	0.20	310	0.30 ±0.03
HK 0603 3N9□-T	RoHS	3.9	±0.3nH	5	100	7	12	15	20	22	6000	8600	0.27	0.20	300	0.30 ±0.03
HK 0603 4N3□-T	RoHS	4.3	±0.3nH	5	100	7	12	15	19	21	5700	8100	0.30	0.22	280	0.30 ±0.03
HK 0603 4N7□-T	RoHS	4.7	±0.3nH	5	100	7	12	15	19	21	5300	7600	0.30	0.24	280	0.30 ±0.03
HK 0603 5N1□-T	RoHS	5.1	±0.3nH	5	100	7	12	15	19	21	5000	7100	0.33	0.26	270	0.30 ±0.03
HK 0603 5N6□-T	RoHS	5.6	±0.3nH	5	100	7	12	15	19	21	4600	6600	0.36	0.27	260	0.30 ±0.03
HK 0603 6N2□-T	RoHS	6.2	±0.3nH	5	100	7	11	14	18	20	4200	6100	0.38	0.29	250	0.30 ±0.03
HK 0603 6N8□-T	RoHS	6.8	±5%	5	100	7	11	14	18	20	3900	5600	0.39	0.30	250	0.30 ±0.03
HK 0603 7N5□-T	RoHS	7.5	±5%	5	100	7	11	14	18	19	3600	5300	0.41	0.34	240	0.30 ±0.03
HK 0603 8N2□-T	RoHS	8.2	±5%	5	100	7	11	14	18	19	3400	4900	0.45	0.34	230	0.30 ±0.03
HK 0603 9N1□-T	RoHS	9.1	±5%	5	100	7	11	14	17	18	3200	4600	0.48	0.40	220	0.30 ±0.03
HK 0603 10N□-T	RoHS	10	±5%	5	100	7	11	14	17	18	2900	4200	0.51	0.41	220	0.30 ±0.03
HK 0603 12N□-T	RoHS	12	±5%	5	100	7	11	14	17	18	2700	3800	0.68	0.45	190	0.30 ±0.03
HK 0603 15N□-T	RoHS	15	±5%	5	100	7	11	13	16	17	2300	3300	0.71	0.50	180	0.30 ±0.03
HK 0603 18N□-T	RoHS	18	±5%	5	100	7	11	13	16	17	2100	3000	0.81	0.57	170	0.30 ±0.03
HK 0603 22N□-T	RoHS	22	±5%	5	100	7	11	13	15	16	1800	2600	1.00	0.71	150	0.30 ±0.03
HK 0603 27N□-T	RoHS	27	±5%	4	100	6	10	12	14	15	1800	2600	1.35	1.11	120	0.30 ±0.03
HK 0603 33N□-T	RoHS	33	±5%	4	100	6	10	12	14	14	1700	2400	1.47	1.33	110	0.30 ±0.03
HK 0603 39N□-T	RoHS	39	±5%	4	100	6	10	12	13	12	1500	2100	1.72	1.51	100	0.30 ±0.03
HK 0603 47N□-T	RoHS	47	±5%	4	100	6	10	11	12	11	1300	1800	1.90	1.74	100	0.30 ±0.03
HK 0603 56N□-T	RoHS	56	±5%	4	100	6	10	11	11	10	1100	1600	2.27	1.85	80	0.30 ±0.03
HK 0603 68N□-T	RoHS	68	±5%	4	100	6	10	11	11	10	1100	1500	2.66	2.30	80	0.30 ±0.03
HK 0603 82N□-T	RoHS	82	±5%	4	100	6	10	11	10	8	1000	1400	3.37	2.60	70	0.30 ±0.03
HK 0603 R10□-T	RoHS	100	±5%	4	100	6	9	10	9	6	900	1200	3.74	3.00	60	0.30 ±0.03

※ □ mark indicates the Inductance tolerance code. Please refer for the inductance tolerance except the above.

●HK 1005

Parts number	EHS	Nominal inductance [nH]	Inductance tolerance ※)	Q (min.)	LQ Measuring frequency [MHz]	Q (Typical) frequency [MHz]					Self-resonant frequency [MHz]		DC Resistance [Ω]		Rated current [mA] (max.)		Thickness [mm]
						100	300	500	800	1000	(min.)	(typ.)	(max.)	(typ.)	-55~+125°C	-55~+85°C	
HK 1005 1N0□-T	RoHS	1.0	±0.3nH	8	100	11	25	34	43	52	10000	> 13000	0.08	0.04	300	900	0.50 ±0.05
HK 1005 1N2□-T	RoHS	1.2	±0.3nH	8	100	11	25	35	44	52	10000	> 13000	0.09	0.04	300	900	0.50 ±0.05
HK 1005 1N5□-T	RoHS	1.5	±0.3nH	8	100	11	24	33	44	48	6000	> 13000	0.10	0.05	300	850	0.50 ±0.05
HK 1005 1N8□-T	RoHS	1.8	±0.3nH	8	100	11	23	30	36	42	6000	11000	0.12	0.06	300	700	0.50 ±0.05
HK 1005 2N0□-T	RoHS	2.0	±0.3nH	8	100	11	21	27	34	39	6000	10500	0.12	0.06	300	700	0.50 ±0.05
HK 1005 2N2□-T	RoHS	2.2	±0.3nH	8	100	10	18	25	31	36	6000	10000	0.13	0.07	300	700	0.50 ±0.05
HK 1005 2N4□-T	RoHS	2.4	±0.3nH	8	100	10	18	24	31	35	6000	9500	0.13	0.07	300	650	0.50 ±0.05
HK 1005 2N7□-T	RoHS	2.7	±0.3nH	8	100	10	18	24	31	34	6000	9000	0.13	0.08	300	650	0.50 ±0.05
HK 1005 3N0□-T	RoHS	3.0	±0.3nH	8	100	10	18	24	31	35	6000	8500	0.16	0.09	300	600	0.50 ±0.05
HK 1005 3N3□-T	RoHS	3.3	±0.3nH	8	100	10	18	24	31	35	6000	8000	0.16	0.10	300	550	0.50 ±0.05
HK 1005 3N6□-T	RoHS	3.6	±0.3nH	8	100	10	18	24	31	35	5000	7500	0.20	0.11	300	500	0.50 ±0.05
HK 1005 3N9□-T	RoHS	3.9	±0.3nH	8	100	10	18	24	31	35	4000	7000	0.21	0.12	300	500	0.50 ±0.05
HK 1005 4N3□-T	RoHS	4.3	±0.3nH	8	100	10	18	24	31	35	4000	6500	0.20	0.12	300	500	0.50 ±0.05
HK 1005 4N7□-T	RoHS	4.7	±0.3nH	8	100	10	18	24	31	34	4000	6000	0.21	0.12	300	500	0.50 ±0.05
HK 1005 5N1□-T	RoHS	5.1	±0.3nH	8	100	10	18	24	31	34	4000	5800	0.21	0.13	300	450	0.50 ±0.05
HK 1005 5N6□-T	RoHS	5.6	±0.3nH	8	100	10	18	24	30	35	4000	5700	0.23	0.15	300	430	0.50 ±0.05
HK 1005 6N2□-T	RoHS	6.2	±0.3nH	8	100	10	18	24	30	34	3900	5600	0.25	0.16	300	430	0.50 ±0.05
HK 1005 6N8□-T	RoHS	6.8	±5%	8	100	10	18	23	29	32	3900	5500	0.25	0.17	300	430	0.50 ±0.05
HK 1005 7N5□-T	RoHS	7.5	±5%	8	100	10	18	23	29	32	3700	5200	0.25	0.18	300	400	0.50 ±0.05
HK 1005 8N2□-T	RoHS	8.2	±5%	8	100	10	18	23	29	31	3600	4900	0.28	0.21	300	380	0.50 ±0.05
HK 1005 9N1□-T	RoHS	9.1	±5%	8	100	10	18	23	29	31	3400	4500	0.30	0.22	300	360	0.50 ±0.05
HK 1005 10N□-T	RoHS	10	±5%	8	100	10	18	23	29	31	3200	4300	0.31	0.23	300	340	0.50 ±0.05
HK 1005 12N□-T	RoHS	12	±5%	8	100	11	18	23	29	31	2700	3900	0.40	0.28	300	330	0.50 ±0.05
HK 1005 15N□-T	RoHS	15	±5%	8	100	11	18	23	28	30	2300	3500	0.46	0.31	300	320	0.50 ±0.05
HK 1005 18N□-T	RoHS	18	±5%	8	100	11	18	23	28	30	2100	3100	0.55	0.35	300	310	0.50 ±0.05
HK 1005 22N□-T	RoHS	22	±5%	8	100	11	17	22	26	27	1900	2800	0.60	0.42	300	300	0.50 ±0.05
HK 1005 27N□-T	RoHS	27	±5%	8	100	11	17	21	25	26	1600	2300	0.70	0.47	300	300	0.50 ±0.05
HK 1005 33N□-T	RoHS	33	±5%	8	100	11	16	20	23	22	1300	1900	0.80	0.50	200	250	0.50 ±0.05
HK 1005 39N□-T	RoHS	39	±5%	8	100	11	16	20	23	21	1200	1700	0.90	0.52	200	250	0.50 ±0.05
HK 1005 47N□-T	RoHS	47	±5%	8	100	11	16	19	21	18	1000	1500	1.00	0.58	200	230	0.50 ±0.05
HK 1005 56N□-T	RoHS	56	±5%	8	100	11	16	18	18	16	750	1300	1.00	0.61	200	220	0.50 ±0.05
HK 1005 68N□-T	RoHS	68	±5%	8	100	11	15	17	18	11	750	1200	1.20	0.70	180	200	0.50 ±0.05
HK 1005 82N□-T	RoHS	82	±5%	8	100	10	14	16	15	6	600	1100	1.30	0.81	150	200	0.50 ±0.05
HK 1005 R10□-T	RoHS	100	±5%	8	100	10	14	14	12	—	600	1000	1.50	0.94	150	200	0.50 ±0.05
HK 1005 R12□-T	RoHS	120	±5%	8	100	10	12	10	—	—	600	800	1.60	1.10	150	200	0.50 ±0.05
HK 1005 R15□-T	RoHS	150	±5%	8	100	12	17	17	—	—	550	920	3.20	2.57	140	200	0.50 ±0.05
HK 1005 R18□-T	RoHS	180	±5%	8	100	12	16	—	—	—	500	810	3.70	2.97	130	200	0.50 ±0.05
HK 1005 R22□-T	RoHS	220	±5%	8	100	12	16	—	—	—	450	700	4.20	3.29	120	200	0.50 ±0.05
HK 1005 R27□-T	RoHS	270	±5%	8	100	12	14	—	—	—	400	600	4.80	3.92	110	200	0.50 ±0.05

※ □ mark indicates the Inductance tolerance code. Please refer for the inductance tolerance except the above.

PARTS NUMBER

HK 1608

Parts number	EHS	Nominal inductance [nH]	Inductance tolerance ※	Q (min.)	LQ Measuring frequency [MHz]	Q (Typical) frequency [MHz]					Self-resonant frequency [MHz]		DC Resistance [Ω]		Rated current [mA] (max.)	Thickness [mm]
						100	300	500	800	1000	(min.)	(typ.)	(max.)	(typ.)		
HK 1608 1N0-T	RoHS	1.0	±0.3nH	8	100	14	30	40	70	90	10000	> 13000	0.05	0.015	300	0.80 ±0.15
HK 1608 1N2-T	RoHS	1.2	±0.3nH	8	100	14	30	40	70	90	10000	> 13000	0.05	0.015	300	0.80 ±0.15
HK 1608 1N5-T	RoHS	1.5	±0.3nH	8	100	14	26	34	47	50	6000	> 13000	0.10	0.03	300	0.80 ±0.15
HK 1608 1N8-T	RoHS	1.8	±0.3nH	8	100	10	18	24	30	34	6000	> 13000	0.10	0.06	300	0.80 ±0.15
HK 1608 2N2-T	RoHS	2.2	±0.3nH	8	100	12	22	29	37	40	6000	12000	0.10	0.06	300	0.80 ±0.15
HK 1608 2N7-T	RoHS	2.7	±0.3nH	10	100	13	24	32	41	45	6000	11000	0.10	0.06	300	0.80 ±0.15
HK 1608 3N3-T	RoHS	3.3	±0.3nH	10	100	14	25	33	42	47	6000	9000	0.12	0.06	300	0.80 ±0.15
HK 1608 3N9-T	RoHS	3.9	±0.3nH	10	100	13	25	33	42	46	6000	8000	0.14	0.07	300	0.80 ±0.15
HK 1608 4N7-T	RoHS	4.7	±0.3nH	10	100	13	25	33	42	47	4000	6500	0.16	0.08	300	0.80 ±0.15
HK 1608 5N6-T	RoHS	5.6	±0.3nH	10	100	14	25	33	42	46	4000	5800	0.18	0.09	300	0.80 ±0.15
HK 1608 6N8-T	RoHS	6.8	±5%	10	100	14	25	33	43	47	4000	5600	0.22	0.11	300	0.80 ±0.15
HK 1608 8N2-T	RoHS	8.2	±5%	10	100	14	26	34	44	48	3500	5200	0.24	0.13	300	0.80 ±0.15
HK 1608 10N-T	RoHS	10	±5%	12	100	14	26	34	43	47	3400	4600	0.26	0.16	300	0.80 ±0.15
HK 1608 12N-T	RoHS	12	±5%	12	100	14	27	35	45	49	2600	4000	0.28	0.17	300	0.80 ±0.15
HK 1608 15N-T	RoHS	15	±5%	12	100	15	28	37	46	51	2300	3400	0.32	0.20	300	0.80 ±0.15
HK 1608 18N-T	RoHS	18	±5%	12	100	15	27	36	44	48	2000	3000	0.35	0.21	300	0.80 ±0.15
HK 1608 22N-T	RoHS	22	±5%	12	100	16	28	36	44	47	1600	2900	0.40	0.25	300	0.80 ±0.15
HK 1608 27N-T	RoHS	27	±5%	12	100	16	29	37	45	46	1400	2200	0.45	0.28	300	0.80 ±0.15
HK 1608 33N-T	RoHS	33	±5%	12	100	17	31	40	46	47	1200	1800	0.55	0.35	300	0.80 ±0.15
HK 1608 39N-T	RoHS	39	±5%	12	100	18	31	39	44	44	1100	1600	0.60	0.38	300	0.80 ±0.15
HK 1608 47N-T	RoHS	47	±5%	12	100	17	28	34	35	34	900	1600	0.70	0.45	300	0.80 ±0.15
HK 1608 56N-T	RoHS	56	±5%	12	100	17	28	34	34	31	900	1400	0.75	0.50	300	0.80 ±0.15
HK 1608 68N-T	RoHS	68	±5%	12	100	18	29	34	30	22	700	1200	0.85	0.55	300	0.80 ±0.15
HK 1608 82N-T	RoHS	82	±5%	12	100	18	28	33	27	—	600	1100	0.95	0.60	300	0.80 ±0.15
HK 1608 R10-T	RoHS	100	±5%	12	100	18	27	28	16	—	600	1000	1.00	0.65	300	0.80 ±0.15
HK 1608 R12-T	RoHS	120	±5%	8	50	16	24	23	—	—	500	800	1.20	0.68	300	0.80 ±0.15
HK 1608 R15-T	RoHS	150	±5%	8	50	13	19	16	—	—	500	800	1.20	0.73	300	0.80 ±0.15
HK 1608 R18-T	RoHS	180	±5%	8	50	13	18	12	—	—	400	700	1.30	0.85	300	0.80 ±0.15
HK 1608 R22-T	RoHS	220	±5%	8	50	12	16	—	—	—	400	600	1.50	0.95	300	0.80 ±0.15
HK 1608 R27-T	RoHS	270	±5%	8	50	14	15	—	—	—	400	550	1.90	1.34	150	0.80 ±0.15
HK 1608 R33-T	RoHS	330	±5%	8	50	14	—	—	—	—	350	480	2.10	1.53	150	0.80 ±0.15
HK 1608 R39-T	RoHS	390	±5%	8	50	13	—	—	—	—	350	410	2.30	1.72	150	0.80 ±0.15
HK 1608 R47-T	RoHS	470	±5%	8	50	13	—	—	—	—	300	360	2.60	2.04	150	0.80 ±0.15

※ □ mark indicates the Inductance tolerance code. Please refer for the inductance tolerance except the above.

HK 2125

Parts number	EHS	Nominal inductance [nH]	Inductance tolerance	Q (min.)	LQ Measuring frequency [MHz]	Q (Typical) frequency [MHz]					Self-resonant frequency [MHz]		DC Resistance [Ω]		Rated current [mA] (max.)	Thickness [mm]
						100	300	500	800	1000	(min.)	(typ.)	(max.)	(typ.)		
HK 2125 1N5S-T	RoHS	1.5	±0.3nH	10	100	21	39	57	61	68	4000	> 6000	0.10	0.02	300	0.85 ±0.2
HK 2125 1N8S-T	RoHS	1.8	±0.3nH	10	100	18	35	49	55	59	4000	> 6000	0.10	0.02	300	0.85 ±0.2
HK 2125 2N2S-T	RoHS	2.2	±0.3nH	10	100	18	33	46	53	58	4000	> 6000	0.10	0.03	300	0.85 ±0.2
HK 2125 2N7S-T	RoHS	2.7	±0.3nH	12	100	19	36	50	56	60	4000	> 6000	0.10	0.03	300	0.85 ±0.2
HK 2125 3N3S-T	RoHS	3.3	±0.3nH	12	100	16	29	40	47	51	4000	> 6000	0.13	0.04	300	0.85 ±0.2
HK 2125 3N9S-T	RoHS	3.9	±0.3nH	12	100	18	33	46	54	60	4000	> 6000	0.15	0.05	300	0.85 ±0.2
HK 2125 4N7S-T	RoHS	4.7	±0.3nH	12	100	18	34	46	55	60	3500	> 6000	0.20	0.05	300	0.85 ±0.2
HK 2125 5N6S-T	RoHS	5.6	±0.3nH	15	100	20	38	51	60	66	3200	5400	0.23	0.05	300	0.85 ±0.2
HK 2125 6N8J-T	RoHS	6.8	±5%	15	100	20	39	52	63	69	2800	4200	0.25	0.06	300	0.85 ±0.2
HK 2125 8N2J-T	RoHS	8.2	±5%	15	100	21	40	54	63	70	2400	3700	0.28	0.07	300	0.85 ±0.2
HK 2125 10NJ-T	RoHS	10	±5%	15	100	20	38	51	60	67	2100	3100	0.30	0.09	300	0.85 ±0.2
HK 2125 12NJ-T	RoHS	12	±5%	15	100	21	39	52	60	67	1900	3000	0.35	0.10	300	0.85 ±0.2
HK 2125 15NJ-T	RoHS	15	±5%	15	100	22	42	55	63	72	1600	2600	0.40	0.11	300	0.85 ±0.2
HK 2125 18NJ-T	RoHS	18	±5%	15	100	24	44	57	63	72	1500	2300	0.45	0.13	300	0.85 ±0.2
HK 2125 22NJ-T	RoHS	22	±5%	18	100	23	43	55	60	69	1400	2100	0.50	0.16	300	0.85 ±0.2
HK 2125 27NJ-T	RoHS	27	±5%	18	100	23	42	53	58	68	1300	1800	0.55	0.17	300	0.85 ±0.2
HK 2125 33NJ-T	RoHS	33	±5%	18	100	24	43	54	55	60	1200	1700	0.60	0.19	300	0.85 ±0.2
HK 2125 39NJ-T	RoHS	39	±5%	18	100	23	41	50	47	47	1000	1400	0.65	0.25	300	0.85 ±0.2
HK 2125 47NJ-T	RoHS	47	±5%	18	100	23	41	49	43	41	900	1200	0.70	0.26	300	1.00 +0.2/-0.3
HK 2125 56NJ-T	RoHS	56	±5%	18	100	23	42	48	39	38	800	1100	0.75	0.28	300	1.00 +0.2/-0.3
HK 2125 68NJ-T	RoHS	68	±5%	18	100	25	42	45	30	—	700	900	0.80	0.33	300	1.00 +0.2/-0.3
HK 2125 82NJ-T	RoHS	82	±5%	18	100	24	41	41	—	—	600	800	0.90	0.37	300	1.00 +0.2/-0.3
HK 2125 R10J-T	RoHS	100	±5%	18	100	23	37	37	—	—	600	800	0.90	0.40	300	1.00 +0.2/-0.3
HK 2125 R12J-T	RoHS	120	±5%	13	50	22	33	29	—	—	500	700	0.95	0.43	300	1.00 +0.2/-0.3
HK 2125 R15J-T	RoHS	150	±5%	13	50	22	34	26	—	—	500	700	1.00	0.46	300	1.00 +0.2/-0.3
HK 2125 R18J-T	RoHS	180	±5%	13	50	23	34	20	—	—	400	600	1.10	0.50	300	1.00 +0.2/-0.3
HK 2125 R22J-T	RoHS	220	±5%	12	50	20	23	—	—	—	350	550	1.20	0.75	300	1.00 +0.2/-0.3
HK 2125 R27J-T	RoHS	270	±5%	12	50	20	29	—	—	—	300	480	1.30	0.85	300	1.00 +0.2/-0.3
HK 2125 R33J-T	RoHS	330	±5%	12	50	22	15	—	—	—	250	400	1.40	0.90	300	1.00 +0.2/-0.3
HK 2125 R39J-T	RoHS	390	±5%	10	50	17	12	—	—	—	250	400	1.30	0.85	300	1.00 +0.2/-0.3
HK 2125 R47J-T	RoHS	470	±5%	10	50	17	—	—	—	—	200	350	1.50	0.95	300	1.00 +0.2/-0.3

※ □ mark indicates the Inductance tolerance code. Please refer for the inductance tolerance except the above.

► This catalog contains the typical specification only due to the limitation of space. When you consider the purchase of our products, please check our product specification sheets. For details of each product (characteristics graph, reliability information, precautions for use, and so on), see our website (<http://www.ty-top.com/>).

INDUCTORS
INDUCTORS FOR HIGH FREQUENCY APPLICATIONS

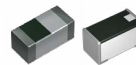

REFLOW

■ PARTS NUMBER

* Operating Temp.: -55~+125°C

H	K	Q	0	6	0	3	S	1	0	N	J	-	T
①			②				③	④			⑤		⑥

△ = Blank space

① Series name

Code	Series name
HKQ	High-Q multilayer chip inductor for high frequency applications
AQ△	

② Dimensions (L × W)

Code	Type (inch)	Dimensions (L × W) [mm]
0603	0603(0201)	0.6 × 0.3
105△	105(0402)	1.0 × 0.6

③ Series code

Code	Series code
△	Standard
S	S
U	U

④ Nominal inductance

Code (example)	Nominal inductance [nH]
3N9	3.9
10N	10.0

※N=0.0(nH type)

⑤ Inductance tolerance

Code	Inductance tolerance
H	±3%
J	±5%
B	±0.1nH
C	±0.2nH
S	±0.3nH

⑥ Packaging

Code	Packaging
-T	Taping
-E	Taping (1mm pitch) 0402type only

■ STANDARD EXTERNAL DIMENSIONS / STANDARD QUANTITY

HKQ0603S, HKQ0603U, AQ 105

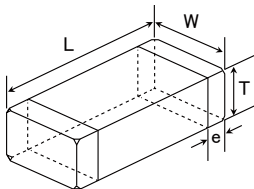

Type	L	W	T	e	Standard quantity [pcs]	
					Paper tape	Embossed tape
HKQ0603S HKQ0603U (0201)	0.6 ± 0.03 (0.024 ± 0.001)	0.3 ± 0.03 (0.012 ± 0.001)	0.3 ± 0.03 (0.012 ± 0.001)	0.1 ± 0.05 (0.004 ± 0.002)	15000	—
AQ 105 (0402)	1.0 ± 0.05 (0.039 ± 0.002)	0.6 ± 0.1 (0.024 ± 0.004)	0.5 ± 0.05 (0.020 ± 0.002)	0.175 ± 0.075 (0.007 ± 0.003)	10000	—

Unit : mm (inch)

► This catalog contains the typical specification only due to the limitation of space. When you consider the purchase of our products, please check our product specification sheets. For details of each product (characteristics graph, reliability information, precautions for use, and so on), see our website (<http://www.ty-top.com/>).

PARTS NUMBER

HKQ0603S

Parts number	EHS	Nominal inductance [nH]	Inductance tolerance	Q (min.)	LQ Measuring frequency [MHz]	Q (Typical) frequency [Hz]					Self-resonant frequency [MHz] (min.)	Resistance DC [Ω] (max.)	Rated current [mA] (max.)	Thickness [mm]
						500M	800M	1.8G	2.0G	2.4G				
HKQ0603S0N6□-T	RoHS	0.6	$\pm 0.2nH, \pm 0.3nH$	13	500	>24	>31	>53	>56	>64	10000	0.06	600	0.30 ± 0.03
HKQ0603S0N7□-T	RoHS	0.7	$\pm 0.2nH, \pm 0.3nH$	13	500	>24	>31	>53	>56	>64	10000	0.07	550	0.30 ± 0.03
HKQ0603S0N8□-T	RoHS	0.8	$\pm 0.2nH, \pm 0.3nH$	13	500	>24	>31	>53	>56	>64	10000	0.07	550	0.30 ± 0.03
HKQ0603S0N9□-T	RoHS	0.9	$\pm 0.2nH, \pm 0.3nH$	13	500	>24	>31	>53	>56	>64	10000	0.08	520	0.30 ± 0.03
HKQ0603S1N0□-T	RoHS	1.0	$\pm 0.2nH, \pm 0.3nH$	13	500	24	31	53	56	64	10000	0.09	490	0.30 ± 0.03
HKQ0603S1N1□-T	RoHS	1.1	$\pm 0.2nH, \pm 0.3nH$	13	500	19	26	44	47	54	10000	0.12	420	0.30 ± 0.03
HKQ0603S1N2□-T	RoHS	1.2	$\pm 0.2nH, \pm 0.3nH$	13	500	19	25	42	44	51	10000	0.15	380	0.30 ± 0.03
HKQ0603S1N3□-T	RoHS	1.3	$\pm 0.2nH, \pm 0.3nH$	13	500	19	25	40	42	47	10000	0.19	330	0.30 ± 0.03
HKQ0603S1N4□-T	RoHS	1.4	$\pm 0.2nH, \pm 0.3nH$	13	500	19	24	39	41	47	10000	0.11	440	0.30 ± 0.03
HKQ0603S1N5□-T	RoHS	1.5	$\pm 0.2nH, \pm 0.3nH$	13	500	19	24	39	41	46	10000	0.12	420	0.30 ± 0.03
HKQ0603S1N6□-T	RoHS	1.6	$\pm 0.2nH, \pm 0.3nH$	13	500	19	24	39	41	46	10000	0.13	410	0.30 ± 0.03
HKQ0603S1N7□-T	RoHS	1.7	$\pm 0.2nH, \pm 0.3nH$	13	500	19	24	39	41	46	10000	0.15	380	0.30 ± 0.03
HKQ0603S1N8□-T	RoHS	1.8	$\pm 0.2nH, \pm 0.3nH$	13	500	18	24	39	41	46	10000	0.16	370	0.30 ± 0.03
HKQ0603S1N9□-T	RoHS	1.9	$\pm 0.2nH, \pm 0.3nH$	13	500	18	23	38	40	45	10000	0.20	330	0.30 ± 0.03
HKQ0603S2N0□-T	RoHS	2.0	$\pm 0.2nH, \pm 0.3nH$	13	500	17	23	37	39	44	10000	0.24	300	0.30 ± 0.03
HKQ0603S2N1□-T	RoHS	2.1	$\pm 0.2nH, \pm 0.3nH$	13	500	17	23	37	39	44	10000	0.26	290	0.30 ± 0.03
HKQ0603S2N2□-T	RoHS	2.2	$\pm 0.2nH, \pm 0.3nH$	13	500	17	23	37	39	43	10000	0.28	270	0.30 ± 0.03
HKQ0603S2N3□-T	RoHS	2.3	$\pm 0.2nH, \pm 0.3nH$	13	500	17	23	36	38	43	10000	0.30	270	0.30 ± 0.03
HKQ0603S2N4□-T	RoHS	2.4	$\pm 0.2nH, \pm 0.3nH$	13	500	17	22	36	38	42	10000	0.32	260	0.30 ± 0.03
HKQ0603S2N5□-T	RoHS	2.5	$\pm 0.2nH, \pm 0.3nH$	13	500	17	22	34	35	39	9500	0.20	330	0.30 ± 0.03
HKQ0603S2N6□-T	RoHS	2.6	$\pm 0.2nH, \pm 0.3nH$	13	500	17	22	33	35	39	9300	0.22	310	0.30 ± 0.03
HKQ0603S2N7□-T	RoHS	2.7	$\pm 0.2nH, \pm 0.3nH$	13	500	17	22	33	35	39	9100	0.24	300	0.30 ± 0.03
HKQ0603S2N8□-T	RoHS	2.8	$\pm 0.2nH, \pm 0.3nH$	13	500	17	22	33	35	39	8900	0.25	290	0.30 ± 0.03
HKQ0603S2N9□-T	RoHS	2.9	$\pm 0.2nH, \pm 0.3nH$	13	500	17	22	33	35	39	8700	0.28	270	0.30 ± 0.03
HKQ0603S3N0□-T	RoHS	3.0	$\pm 0.2nH, \pm 0.3nH$	13	500	17	22	33	35	39	8600	0.28	270	0.30 ± 0.03
HKQ0603S3N1□-T	RoHS	3.1	$\pm 0.2nH, \pm 0.3nH$	13	500	17	22	33	35	39	8400	0.29	270	0.30 ± 0.03
HKQ0603S3N2□-T	RoHS	3.2	$\pm 0.2nH, \pm 0.3nH$	13	500	17	22	33	35	39	8200	0.30	270	0.30 ± 0.03
HKQ0603S3N3□-T	RoHS	3.3	$\pm 0.2nH, \pm 0.3nH$	13	500	17	22	33	35	39	8100	0.32	260	0.30 ± 0.03
HKQ0603S3N4□-T	RoHS	3.4	$\pm 0.2nH, \pm 0.3nH$	13	500	16	22	33	35	39	8000	0.36	240	0.30 ± 0.03
HKQ0603S3N5□-T	RoHS	3.5	$\pm 0.2nH, \pm 0.3nH$	13	500	16	22	33	35	39	7800	0.40	230	0.30 ± 0.03
HKQ0603S3N6□-T	RoHS	3.6	$\pm 0.2nH, \pm 0.3nH$	13	500	16	22	33	35	39	7700	0.41	230	0.30 ± 0.03
HKQ0603S3N7□-T	RoHS	3.7	$\pm 0.2nH, \pm 0.3nH$	13	500	16	22	33	35	38	7600	0.44	220	0.30 ± 0.03
HKQ0603S3N8□-T	RoHS	3.8	$\pm 0.2nH, \pm 0.3nH$	13	500	16	22	33	35	38	7500	0.48	210	0.30 ± 0.03
HKQ0603S3N9□-T	RoHS	3.9	$\pm 0.2nH, \pm 0.3nH$	13	500	16	22	33	35	38	7300	0.48	210	0.30 ± 0.03
HKQ0603S4N3□-T	RoHS	4.3	$\pm 0.2nH, \pm 0.3nH$	13	500	16	21	32	34	37	6500	0.39	230	0.30 ± 0.03
HKQ0603S4N7□-T	RoHS	4.7	$\pm 0.2nH, \pm 0.3nH$	13	500	16	21	32	34	37	6200	0.44	220	0.30 ± 0.03
HKQ0603S5N1□-T	RoHS	5.1	$\pm 0.2nH, \pm 0.3nH$	13	500	16	21	32	34	37	5900	0.49	210	0.30 ± 0.03
HKQ0603S5N6□-T	RoHS	5.6	$\pm 0.2nH, \pm 0.3nH$	13	500	16	21	32	34	37	5500	0.47	210	0.30 ± 0.03
HKQ0603S6N2□-T	RoHS	6.2	$\pm 0.2nH, \pm 0.3nH$	13	500	16	21	32	33	36	5100	0.52	200	0.30 ± 0.03
HKQ0603S6N8□-T	RoHS	6.8	$\pm 3\%, \pm 5\%$	13	500	16	21	31	32	35	4800	0.55	190	0.30 ± 0.03
HKQ0603S7N5□-T	RoHS	7.5	$\pm 3\%, \pm 5\%$	13	500	16	20	30	32	34	4600	0.51	200	0.30 ± 0.03
HKQ0603S8N2□-T	RoHS	8.2	$\pm 3\%, \pm 5\%$	13	500	16	20	30	31	33	4300	0.57	190	0.30 ± 0.03
HKQ0603S9N1□-T	RoHS	9.1	$\pm 3\%, \pm 5\%$	13	500	16	20	30	30	32	4000	0.73	170	0.30 ± 0.03
HKQ0603S10N□-T	RoHS	10	$\pm 3\%, \pm 5\%$	13	500	16	20	28	29	31	3800	0.85	160	0.30 ± 0.03
HKQ0603S12N□-T	RoHS	12	$\pm 3\%, \pm 5\%$	12	500	16	20	27	27	27	3300	0.85	160	0.30 ± 0.03
HKQ0603S15N□-T	RoHS	15	$\pm 3\%, \pm 5\%$	12	500	15	19	24	24	23	2600	0.89	150	0.30 ± 0.03
HKQ0603S18N□-T	RoHS	18	$\pm 3\%, \pm 5\%$	11	500	15	19	23	23	21	2300	1.05	140	0.30 ± 0.03
HKQ0603S22N□-T	RoHS	22	$\pm 3\%, \pm 5\%$	10	500	15	19	22	22	19	1900	1.29	130	0.30 ± 0.03

※ □ mark indicates the Inductance tolerance code.

INDUCTORS

INDUCTORS FOR HIGH FREQUENCY APPLICATIONS

▶ This catalog contains the typical specification only due to the limitation of space. When you consider the purchase of our products, please check our product specification sheets. For details of each product (characteristics graph, reliability information, precautions for use, and so on), see our website (<http://www.ty-top.com/>).

PARTS NUMBER

HKQ0603U

Parts number	EHS	Nominal inductance [nH]	Inductance tolerance	Q (min.)	LQ Measuring frequency [MHz]	Q (Typical) frequency [Hz]					Self-resonant frequency [MHz] (min.)	Resistance DC [Ω] (max.)	Rated current [mA] (max.)	Thickness [mm]
						500M	800M	1.8G	2.0G	2.4G				
HKQ0603U0N6□-T	RoHS	0.6	$\pm 0.1nH, \pm 0.2nH, \pm 0.3nH$	14	500	>35	>47	>75	>80	>88	10000	0.06	900	0.30 ± 0.03
HKQ0603U0N7□-T	RoHS	0.7	$\pm 0.1nH, \pm 0.2nH, \pm 0.3nH$	14	500	>35	>47	>75	>80	>88	10000	0.06	900	0.30 ± 0.03
HKQ0603U0N8□-T	RoHS	0.8	$\pm 0.1nH, \pm 0.2nH, \pm 0.3nH$	14	500	>35	>47	>75	>80	>88	10000	0.06	900	0.30 ± 0.03
HKQ0603U0N9□-T	RoHS	0.9	$\pm 0.1nH, \pm 0.2nH, \pm 0.3nH$	14	500	>35	>47	>75	>80	>88	10000	0.06	900	0.30 ± 0.03
HKQ0603U1N0□-T	RoHS	1.0	$\pm 0.1nH, \pm 0.2nH, \pm 0.3nH$	14	500	>35	>47	>75	>80	>88	10000	0.07	850	0.30 ± 0.03
HKQ0603U1N1□-T	RoHS	1.1	$\pm 0.1nH, \pm 0.2nH, \pm 0.3nH$	14	500	>35	>47	>75	>80	>88	10000	0.07	850	0.30 ± 0.03
HKQ0603U1N2□-T	RoHS	1.2	$\pm 0.1nH, \pm 0.2nH, \pm 0.3nH$	14	500	35	47	75	80	88	10000	0.08	800	0.30 ± 0.03
HKQ0603U1N3□-T	RoHS	1.3	$\pm 0.1nH, \pm 0.2nH, \pm 0.3nH$	14	500	32	43	70	74	82	10000	0.09	760	0.30 ± 0.03
HKQ0603U1N4□-T	RoHS	1.4	$\pm 0.1nH, \pm 0.2nH, \pm 0.3nH$	14	500	29	39	63	67	75	10000	0.12	640	0.30 ± 0.03
HKQ0603U1N5□-T	RoHS	1.5	$\pm 0.1nH, \pm 0.2nH, \pm 0.3nH$	14	500	27	36	59	62	69	10000	0.15	600	0.30 ± 0.03
HKQ0603U1N6□-T	RoHS	1.6	$\pm 0.1nH, \pm 0.2nH, \pm 0.3nH$	14	500	25	33	54	57	63	10000	0.19	510	0.30 ± 0.03
HKQ0603U1N7□-T	RoHS	1.7	$\pm 0.1nH, \pm 0.2nH, \pm 0.3nH$	14	500	25	32	52	54	61	10000	0.11	680	0.30 ± 0.03
HKQ0603U1N8□-T	RoHS	1.8	$\pm 0.1nH, \pm 0.2nH, \pm 0.3nH$	14	500	25	32	51	53	59	10000	0.12	640	0.30 ± 0.03
HKQ0603U1N9□-T	RoHS	1.9	$\pm 0.1nH, \pm 0.2nH, \pm 0.3nH$	14	500	24	31	50	53	58	10000	0.13	620	0.30 ± 0.03
HKQ0603U2N0□-T	RoHS	2.0	$\pm 0.1nH, \pm 0.2nH, \pm 0.3nH$	14	500	24	31	50	53	58	10000	0.15	600	0.30 ± 0.03
HKQ0603U2N1□-T	RoHS	2.1	$\pm 0.1nH, \pm 0.2nH, \pm 0.3nH$	14	500	24	31	50	53	58	10000	0.16	550	0.30 ± 0.03
HKQ0603U2N2□-T	RoHS	2.2	$\pm 0.1nH, \pm 0.2nH, \pm 0.3nH$	14	500	24	31	50	53	58	10000	0.20	500	0.30 ± 0.03
HKQ0603U2N3□-T	RoHS	2.3	$\pm 0.1nH, \pm 0.2nH, \pm 0.3nH$	14	500	24	31	49	52	58	10000	0.24	460	0.30 ± 0.03
HKQ0603U2N4□-T	RoHS	2.4	$\pm 0.1nH, \pm 0.2nH, \pm 0.3nH$	14	500	22	28	45	48	53	10000	0.26	430	0.30 ± 0.03
HKQ0603U2N5□-T	RoHS	2.5	$\pm 0.1nH, \pm 0.2nH, \pm 0.3nH$	14	500	22	29	46	49	54	10000	0.28	415	0.30 ± 0.03
HKQ0603U2N6□-T	RoHS	2.6	$\pm 0.1nH, \pm 0.2nH, \pm 0.3nH$	14	500	21	27	44	46	51	10000	0.30	405	0.30 ± 0.03
HKQ0603U2N7□-T	RoHS	2.7	$\pm 0.1nH, \pm 0.2nH, \pm 0.3nH$	14	500	20	26	41	43	48	10000	0.32	400	0.30 ± 0.03
HKQ0603U2N8□-T	RoHS	2.8	$\pm 0.1nH, \pm 0.2nH, \pm 0.3nH$	14	500	20	26	41	43	47	9500	0.20	500	0.30 ± 0.03
HKQ0603U2N9□-T	RoHS	2.9	$\pm 0.1nH, \pm 0.2nH, \pm 0.3nH$	14	500	20	26	41	43	47	9300	0.22	480	0.30 ± 0.03
HKQ0603U3N0□-T	RoHS	3.0	$\pm 0.1nH, \pm 0.2nH, \pm 0.3nH$	14	500	20	26	41	43	47	9100	0.24	460	0.30 ± 0.03
HKQ0603U3N1□-T	RoHS	3.1	$\pm 0.1nH, \pm 0.2nH, \pm 0.3nH$	14	500	20	26	41	43	47	8900	0.25	450	0.30 ± 0.03
HKQ0603U3N2□-T	RoHS	3.2	$\pm 0.1nH, \pm 0.2nH, \pm 0.3nH$	14	500	20	26	40	43	47	8700	0.28	415	0.30 ± 0.03
HKQ0603U3N3□-T	RoHS	3.3	$\pm 0.1nH, \pm 0.2nH, \pm 0.3nH$	14	500	20	26	40	43	47	8600	0.28	415	0.30 ± 0.03
HKQ0603U3N4□-T	RoHS	3.4	$\pm 0.1nH, \pm 0.2nH, \pm 0.3nH$	14	500	20	25	40	43	47	8400	0.29	410	0.30 ± 0.03
HKQ0603U3N5□-T	RoHS	3.5	$\pm 0.1nH, \pm 0.2nH, \pm 0.3nH$	14	500	20	25	40	42	46	8200	0.30	405	0.30 ± 0.03
HKQ0603U3N6□-T	RoHS	3.6	$\pm 0.1nH, \pm 0.2nH, \pm 0.3nH$	14	500	19	25	40	42	46	8100	0.32	400	0.30 ± 0.03
HKQ0603U3N7□-T	RoHS	3.7	$\pm 0.1nH, \pm 0.2nH, \pm 0.3nH$	14	500	19	25	40	42	46	8000	0.36	370	0.30 ± 0.03
HKQ0603U3N8□-T	RoHS	3.8	$\pm 0.1nH, \pm 0.2nH, \pm 0.3nH$	14	500	19	25	39	41	45	7800	0.40	355	0.30 ± 0.03
HKQ0603U3N9□-T	RoHS	3.9	$\pm 0.1nH, \pm 0.2nH, \pm 0.3nH$	14	500	19	25	39	41	45	7700	0.41	350	0.30 ± 0.03
HKQ0603U4N0□-T	RoHS	4.0	$\pm 0.1nH, \pm 0.2nH, \pm 0.3nH$	14	500	18	25	39	41	45	7600	0.44	335	0.30 ± 0.03
HKQ0603U4N1□-T	RoHS	4.1	$\pm 0.1nH, \pm 0.2nH, \pm 0.3nH$	14	500	19	25	39	41	45	7500	0.48	320	0.30 ± 0.03
HKQ0603U4N2□-T	RoHS	4.2	$\pm 0.1nH, \pm 0.2nH, \pm 0.3nH$	14	500	18	24	37	39	43	7300	0.48	320	0.30 ± 0.03
HKQ0603U4N3□-T	RoHS	4.3	$\pm 0.2nH, \pm 0.3nH$	14	500	18	24	37	39	43	6500	0.48	320	0.30 ± 0.03
HKQ0603U4N6□-T	RoHS	4.6	$\pm 0.2nH, \pm 0.3nH$	14	500	18	24	37	39	42	6500	0.39	360	0.30 ± 0.03
HKQ0603U4N7□-T	RoHS	4.7	$\pm 0.2nH, \pm 0.3nH$	14	500	19	24	37	39	42	6400	0.42	350	0.30 ± 0.03
HKQ0603U5N0□-T	RoHS	5.0	$\pm 0.2nH, \pm 0.3nH$	14	500	19	24	37	39	42	6200	0.44	335	0.30 ± 0.03
HKQ0603U5N1□-T	RoHS	5.1	$\pm 0.2nH, \pm 0.3nH$	14	500	19	24	37	39	42	6100	0.45	330	0.30 ± 0.03
HKQ0603U5N4□-T	RoHS	5.4	$\pm 0.2nH, \pm 0.3nH$	14	500	18	24	36	38	42	5900	0.49	315	0.30 ± 0.03
HKQ0603U5N6□-T	RoHS	5.6	$\pm 0.2nH, \pm 0.3nH$	14	500	18	24	36	37	41	5500	0.47	325	0.30 ± 0.03
HKQ0603U5N9□-T	RoHS	5.9	$\pm 0.2nH, \pm 0.3nH$	14	500	18	23	35	36	39	5500	0.47	325	0.30 ± 0.03
HKQ0603U6N2□-T	RoHS	6.2	$\pm 0.2nH, \pm 0.3nH$	14	500	18	23	35	36	39	5100	0.52	305	0.30 ± 0.03
HKQ0603U6N5□-T	RoHS	6.5	$\pm 0.2nH, \pm 0.3nH$	14	500	18	23	35	36	39	5100	0.52	305	0.30 ± 0.03
HKQ0603U6N8□-T	RoHS	6.8	$\pm 3\%, \pm 5\%$	14	500	18	23	35	36	39	4800	0.55	305	0.30 ± 0.03
HKQ0603U7N1□-T	RoHS	7.1	$\pm 3\%, \pm 5\%$	14	500	18	23	35	36	39	4800	0.55	305	0.30 ± 0.03
HKQ0603U7N5□-T	RoHS	7.5	$\pm 3\%, \pm 5\%$	14	500	18	23	34	35	38	4600	0.55	305	0.30 ± 0.03
HKQ0603U7N8□-T	RoHS	7.8	$\pm 3\%, \pm 5\%$	14	500	17	22	33	34	36	4600	0.51	310	0.30 ± 0.03
HKQ0603U8N2□-T	RoHS	8.2	$\pm 3\%, \pm 5\%$	14	500	17	22	33	34	36	4300	0.57	290	0.30 ± 0.03
HKQ0603U8N5□-T	RoHS	8.5	$\pm 3\%, \pm 5\%$	14	500	17	22	33	34	36	4300	0.57	290	0.30 ± 0.03
HKQ0603U9N1□-T	RoHS	9.1	$\pm 3\%, \pm 5\%$	14	500	17	22	33	34	36	4000	0.65	270	0.30 ± 0.03
HKQ0603U9N4□-T	RoHS	9.4	$\pm 3\%, \pm 5\%$	14	500	17	22	33	34	36	4000	0.73	250	0.30 ± 0.03
HKQ0603U10N□-T	RoHS	10	$\pm 3\%, \pm 5\%$	14	500	17	22	33	34	36	3800	0.85	230	0.30 ± 0.03
HKQ0603U12N□-T	RoHS	12	$\pm 3\%, \pm 5\%$	14	500	17	22	31	32	33	3300	0.85	230	0.30 ± 0.03
HKQ0603U15N□-T	RoHS	15	$\pm 3\%, \pm 5\%$	14	500	17	21	28	29	29	2600	0.89	220	0.30 ± 0.03
HKQ0603U18N□-T	RoHS	18	$\pm 3\%, \pm 5\%$	14	500	16	21	26	26	25	2300	1.05	205	0.30 ± 0.03
HKQ0603U22N□-T	RoHS	22	$\pm 3\%, \pm 5\%$	14	500	16	21	26	26	24	1900	1.29	190	0.30 ± 0.03

※ □ mark indicates the Inductance tolerance code.

▶ This catalog contains the typical specification only due to the limitation of space. When you consider the purchase of our products, please check our product specification sheets. For details of each product (characteristics graph, reliability information, precautions for use, and so on), see our website (<http://www.ty-top.com/>).

■ PARTS NUMBER

● AQ 105

Parts number	EHS	Nominal inductance [nH]	Inductance tolerance ※)	Q (min.)	LQ Measuring frequency [MHz]	Q (Typical) frequency [MHz]					Self-resonant frequency [MHz]		Resistance DC [Ω]		Rated current [mA] (max.)		Thickness [mm]
						300	800	900	1500	1800	(min.)	(typ.)	(max.)	(typ.)	-55~+125°C	-55~+85°C	
AQ 105 1N0□-T	RoHS	1.0	±0.3nH	8	100	53	129	147	217	244	10000	> 13000	0.07	0.014	710	930	0.50 ±0.05
AQ 105 1N2□-T	RoHS	1.2	±0.3nH	8	100	45	97	110	156	177	10000	> 13000	0.07	0.016	710	930	0.50 ±0.05
AQ 105 1N5□-T	RoHS	1.5	±0.3nH	8	100	35	69	76	104	116	8000	> 13000	0.07	0.030	710	930	0.50 ±0.05
AQ 105 1N8□-T	RoHS	1.8	±0.3nH	8	100	32	61	66	92	100	6000	11000	0.07	0.035	710	930	0.50 ±0.05
AQ 105 2N0□-T	RoHS	2.0	±0.3nH	8	100	38	68	73	94	103	6000	10500	0.08	0.035	660	870	0.50 ±0.05
AQ 105 2N2□-T	RoHS	2.2	±0.3nH	8	100	37	67	71	92	101	6000	10000	0.08	0.040	660	870	0.50 ±0.05
AQ 105 2N4□-T	RoHS	2.4	±0.3nH	8	100	34	54	59	74	86	6000	9600	0.09	0.050	630	820	0.50 ±0.05
AQ 105 2N7□-T	RoHS	2.7	±0.3nH	8	100	30	49	52	67	73	6000	9200	0.09	0.060	630	820	0.50 ±0.05
AQ 105 3N0□-T	RoHS	3.0	±0.3nH	8	100	31	51	54	70	76	6000	8700	0.11	0.070	570	740	0.50 ±0.05
AQ 105 3N3□-T	RoHS	3.3	±0.3nH	8	100	32	54	57	72	79	6000	8300	0.12	0.075	540	710	0.50 ±0.05
AQ 105 3N6□-T	RoHS	3.6	±0.3nH	8	100	33	53	56	71	77	5000	7800	0.14	0.080	500	650	0.50 ±0.05
AQ 105 3N9□-T	RoHS	3.9	±0.3nH	8	100	34	53	56	70	76	4000	7300	0.15	0.085	490	630	0.50 ±0.05
AQ 105 4N3□-T	RoHS	4.3	±0.3nH	8	100	29	47	50	64	71	4000	6900	0.16	0.090	470	610	0.50 ±0.05
AQ 105 4N7□-T	RoHS	4.7	±0.3nH	8	100	30	48	51	65	72	4000	6400	0.17	0.095	450	590	0.50 ±0.05
AQ 105 5N1□-T	RoHS	5.1	±0.3nH	8	100	30	48	51	64	71	4000	6300	0.19	0.110	430	560	0.50 ±0.05
AQ 105 5N6□-T	RoHS	5.6	±0.3nH	8	100	30	48	51	65	71	4000	6200	0.20	0.120	420	550	0.50 ±0.05
AQ 105 6N2□-T	RoHS	6.2	±0.3nH	8	100	31	49	52	66	72	3900	6100	0.22	0.130	400	520	0.50 ±0.05
AQ 105 6N8□-T	RoHS	6.8	±5%	8	100	28	44	49	59	64	3900	6000	0.23	0.130	390	510	0.50 ±0.05
AQ 105 7N5□-T	RoHS	7.5	±5%	8	100	28	45	50	60	65	3700	5500	0.25	0.135	370	490	0.50 ±0.05
AQ 105 8N2□-T	RoHS	8.2	±5%	8	100	29	46	50	62	66	3600	5000	0.27	0.140	360	470	0.50 ±0.05
AQ 105 9N1□-T	RoHS	9.1	±5%	8	100	29	45	49	59	62	3400	4800	0.29	0.150	350	450	0.50 ±0.05
AQ 105 10N□-T	RoHS	10	±5%	8	100	28	45	48	57	60	3200	4500	0.31	0.165	330	440	0.50 ±0.05
AQ 105 12N□-T	RoHS	12	±5%	8	100	26	40	45	51	52	2700	4300	0.39	0.165	300	390	0.50 ±0.05
AQ 105 15N□-T	RoHS	15	±5%	8	100	25	38	42	49	51	2300	4100	0.45	0.190	280	360	0.50 ±0.05

※ □ mark indicates the Inductance tolerance code. Please refer for the inductance tolerance except the above.

INDUCTORS

INDUCTORS FOR HIGH FREQUENCY APPLICATIONS

▶ This catalog contains the typical specification only due to the limitation of space. When you consider the purchase of our products, please check our product specification sheets. For details of each product (characteristics graph, reliability information, precautions for use, and so on), see our website (<http://www.ty-top.com/>).

Multilayer chip inductors

Multilayer chip inductors for high frequency, Multilayer chip bead inductors

Multilayer common mode choke coils (MC series F type)

Metal Multilayer Chip Power Inductors (MCOIL™ MC series)

PACKAGING

① Minimum Quantity

● Tape & Reel Packaging

Type	Thickness mm (inch)	Standard Quantity [pcs]	
		Paper Tape	Embossed Tape
CK1608(0603)	0.8 (0.031)	4000	—
CK2125(0805)	0.85(0.033)	4000	—
	1.25(0.049)	—	2000
CKS2125(0805)	0.85(0.033)	4000	—
	1.25(0.049)	—	2000
CKP1608(0603)	0.8 (0.031)	4000	—
CKP2012(0805)	0.9 (0.035)	—	3000
CKP2016(0806)	0.9 (0.035)	—	3000
CKP2520(1008)	0.7 (0.028)	—	3000
	0.9 (0.035)	—	3000
	1.1 (0.043)	—	2000
LK1005(0402)	0.5 (0.020)	10000	—
LK1608(0603)	0.8 (0.031)	4000	—
LK2125(0805)	0.85(0.033)	4000	—
	1.25(0.049)	—	2000
HK0603(0201)	0.3 (0.012)	15000	—
HK1005(0402)	0.5 (0.020)	10000	—
HK1608(0603)	0.8 (0.031)	4000	—
HK2125(0805)	0.85(0.033)	—	4000
	1.0 (0.039)	—	3000
HKQ0603W(0201)	0.3 (0.012)	15000	—
HKQ0603S(0201)	0.3 (0.012)	15000	—
HKQ0603U(0201)	0.3 (0.012)	15000	—
AQ105(0402)	0.5 (0.020)	10000	—
BK0603(0201)	0.3 (0.012)	15000	—
BK1005(0402)	0.5 (0.020)	10000	—
BKH0603(0201)	0.3 (0.012)	15000	—
BKH1005(0402)	0.5 (0.020)	10000	—
BK1608(0603)	0.8 (0.031)	4000	—
BK2125(0805)	0.85(0.033)	4000	—
	1.25(0.049)	—	2000
BK2010(0804)	0.45(0.018)	4000	—
BK3216(1206)	0.8 (0.031)	—	4000
BKP0603(0201)	0.3 (0.012)	15000	—
BKP1005(0402)	0.5 (0.020)	10000	—
BKP1608(0603)	0.8 (0.031)	4000	—
BKP2125(0805)	0.85(0.033)	4000	—
MCF0605(0202)	0.3 (0.012)	15000	—
MCF0806(0302)	0.4 (0.016)	—	10000
MCF1210(0504)	0.55(0.022)	—	5000
MCF2010(0804)	0.45(0.018)	—	4000
MCEE1005(0402)	0.55(0.022)	10000	—
MCFK1608(0603)	0.6 (0.024)	4000	—
MCFE1608(0603)	0.65(0.026)	4000	—
MCKK1608(0603)	1.0 (0.039)	—	3000
MCHK2012(0806)	0.8 (0.031)	4000	—
MCKK2012(0805)	1.0 (0.039)	—	3000

This catalog contains the typical specification only due to the limitation of space. When you consider the purchase of our products, please check our specification. For details of each product (characteristics graph, reliability information, precautions for use, and so on), see our Web site (<http://www.ty-top.com/>).

② Taping material

● Card board carrier tape

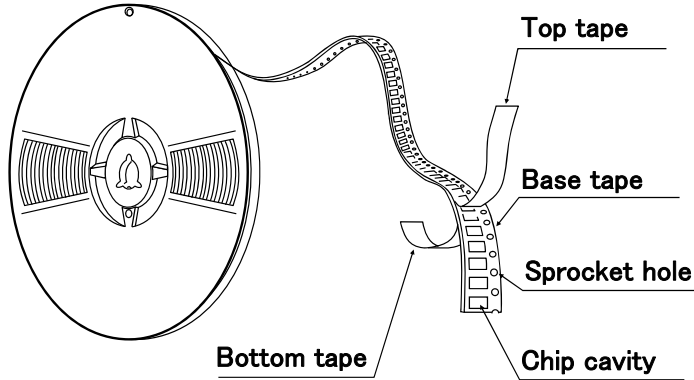

CK	1608
CKP	1608
CK	2125
CKS	2125
LK	1005
LK	1608
LK	2125
HK	0603
HK	1005
HK	1608
HKQ	0603
AQ	105

BK	0603
BK	1005
BK	1608
BK	2125
BK	2010
BKP	0603
BKP	1005
BKP	1608
BKP	2125
BKH	0603
BKH	1005
MCF	0605
MC	1005
MC	1608
MC	2012

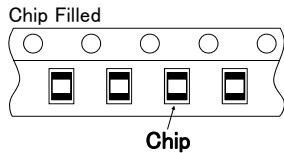

● Embossed Tape

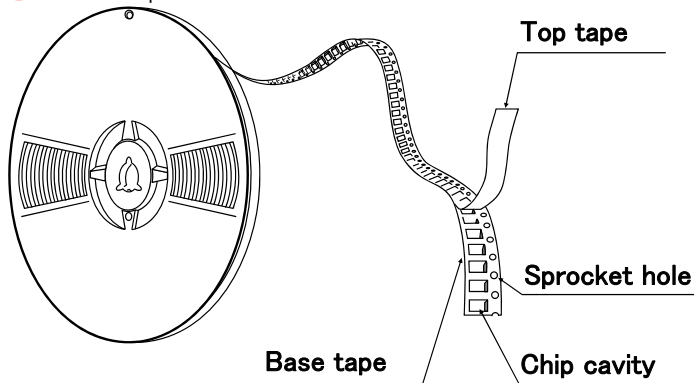

CK	2125
CKS	2125
CKP	2012
CKP	2016
CKP	2520
LK	2125
HK	2125

BK	2125
BK	3216
MCF	0806
MCF	1210
MCF	2010
MC	1608
MC	2012

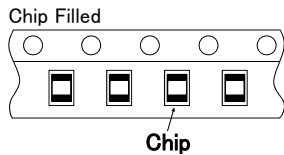

③ Taping Dimensions

● Paper tape (8mm wide)

Unit: mm (inch)

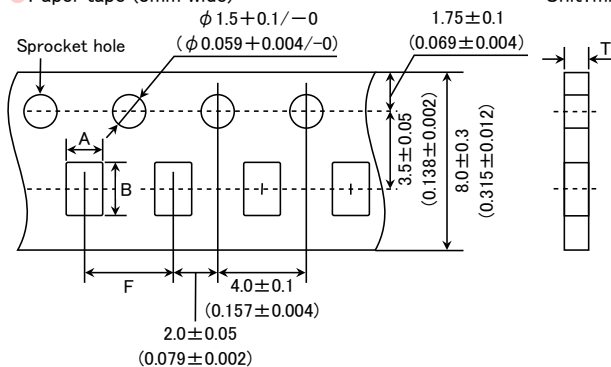

This catalog contains the typical specification only due to the limitation of space. When you consider the purchase of our products, please check our specification. For details of each product (characteristics graph, reliability information, precautions for use, and so on), see our Web site (<http://www.ty-top.com/>).

Type	Thickness mm (inch)	Chip cavity		Insertion Pitch	Tape Thickness
				F	T
CK1608(0603)	0.8 (0.031)	1.0±0.2 (0.039±0.008)	1.8±0.2 (0.071±0.008)	4.0±0.1 (0.157±0.004)	1.1max (0.043max)
CK2125(0805)	0.85(0.033)	1.5±0.2 (0.059±0.008)	2.3±0.2 (0.091±0.008)	4.0±0.1 (0.157±0.004)	1.1max (0.043max)
CKS2125(0805)	0.85(0.033)	1.5±0.2 (0.059±0.008)	2.3±0.2 (0.091±0.008)	4.0±0.1 (0.157±0.004)	1.1max (0.043max)
CKP1608(0603)	0.8 (0.031)	1.0±0.2 (0.039±0.008)	1.8±0.2 (0.071±0.008)	4.0±0.1 (0.157±0.004)	1.1max (0.043max)
LK1005(0402)	0.5 (0.020)	0.65±0.1 (0.026±0.004)	1.15±0.1 (0.045±0.004)	2.0±0.05 (0.079±0.002)	0.8max (0.031max)
LK1608(0603)	0.8 (0.031)	1.0±0.2 (0.039±0.008)	1.8±0.2 (0.071±0.008)	4.0±0.1 (0.157±0.004)	1.1max (0.043max)
LK2125(0805)	0.85(0.033)	1.5±0.2 (0.059±0.008)	2.3±0.2 (0.091±0.008)	4.0±0.1 (0.157±0.004)	1.1max (0.043max)
HK0603(0201)	0.3 (0.012)	0.40±0.06 (0.016±0.002)	0.70±0.06 (0.028±0.002)	2.0±0.05 (0.079±0.002)	0.45max (0.018max)
HK1005(0402)	0.5 (0.020)	0.65±0.1 (0.026±0.004)	1.15±0.1 (0.045±0.004)	2.0±0.05 (0.079±0.002)	0.8max (0.031max)
HK1608(0603)	0.8 (0.031)	1.0±0.2 (0.039±0.008)	1.8±0.2 (0.071±0.008)	4.0±0.1 (0.157±0.004)	1.1max (0.043max)
HKQ0603W(0201)	0.3 (0.012)	0.40±0.06 (0.016±0.002)	0.70±0.06 (0.028±0.002)	2.0±0.05 (0.079±0.002)	0.45max (0.018max)
HKQ0603S(0201)	0.3 (0.012)	0.40±0.06 (0.016±0.002)	0.70±0.06 (0.028±0.002)	2.0±0.05 (0.079±0.002)	0.45max (0.018max)
HKQ0603U(0201)	0.3 (0.012)	0.40±0.06 (0.016±0.002)	0.70±0.06 (0.028±0.002)	2.0±0.05 (0.079±0.002)	0.45max (0.018max)
AQ105(0402)	0.5 (0.020)	0.75±0.1 (0.030±0.004)	1.15±0.1 (0.045±0.004)	2.0±0.05 (0.079±0.002)	0.8max (0.031max)
BK0603(0201)	0.3 (0.012)	0.40±0.06 (0.016±0.002)	0.70±0.06 (0.028±0.002)	2.0±0.05 (0.079±0.002)	0.45max (0.018max)
BK1005(0402)	0.5 (0.020)	0.65±0.1 (0.026±0.004)	1.15±0.1 (0.045±0.004)	2.0±0.05 (0.079±0.002)	0.8max (0.031max)
BK1608(0603)	0.8 (0.031)	1.0±0.2 (0.039±0.008)	1.8±0.2 (0.071±0.008)	4.0±0.1 (0.157±0.004)	1.1max (0.043max)
BK2125(0805)	0.85(0.033)	1.5±0.2 (0.059±0.008)	2.3±0.2 (0.091±0.008)	4.0±0.1 (0.157±0.004)	1.1max (0.043max)
BK2010(0804)	0.45(0.018)	1.2±0.1 (0.047±0.004)	2.17±0.1 (0.085±0.004)	4.0±0.1 (0.157±0.004)	0.8max (0.031max)
BKP0603(0201)	0.3 (0.012)	0.40±0.06 (0.016±0.002)	0.70±0.06 (0.028±0.002)	2.0±0.05 (0.079±0.002)	0.45max (0.018max)
BKP1005(0402)	0.5 (0.020)	0.65±0.1 (0.026±0.004)	1.15±0.1 (0.045±0.004)	2.0±0.05 (0.079±0.002)	0.8max (0.031max)
BKP1608(0603)	0.8 (0.031)	1.0±0.2 (0.039±0.008)	1.8±0.2 (0.071±0.008)	4.0±0.1 (0.157±0.004)	1.1max (0.043max)
BKP2125(0805)	0.85(0.033)	1.5±0.2 (0.059±0.008)	2.3±0.2 (0.091±0.008)	4.0±0.1 (0.157±0.004)	1.1max (0.043max)
BKH0603(0201)	0.3 (0.012)	0.40±0.06 (0.016±0.002)	0.70±0.06 (0.028±0.002)	2.0±0.05 (0.079±0.002)	0.45max (0.018max)
BKH1005(0402)	0.5 (0.020)	0.65±0.1 (0.026±0.004)	1.15±0.1 (0.045±0.004)	2.0±0.05 (0.079±0.002)	0.8max (0.031max)
MCF0605(0202)	0.3 (0.012)	0.62±0.03 (0.024±0.001)	0.77±0.03 (0.030±0.001)	2.0±0.05 (0.079±0.002)	0.45max (0.018max)
MCFK1608(0603)	0.6 (0.024)	1.1±0.05 (0.043±0.002)	1.9±0.05 (0.075±0.002)	4.0±0.1 (0.157±0.004)	0.72max (0.028max)
MCEE1005(0402)	0.55(0.021)	0.8±0.05 (0.031±0.002)	1.3±0.05 (0.051±0.002)	2.0±0.05 (0.079±0.002)	0.6max (0.016max)
MCFE1608(0603)	0.65(0.026)	1.1±0.05 (0.043±0.002)	1.9±0.05 (0.075±0.002)	4.0±0.1 (0.157±0.004)	0.9max (0.035max)
MCHK2012(0805)	0.8 (0.031)	1.55±0.2 (0.061±0.008)	2.3±0.2 (0.091±0.008)	4.0±0.1 (0.157±0.004)	0.9max (0.035max)

Unit : mm (inch)

● Embossed Tape (8mm wide)

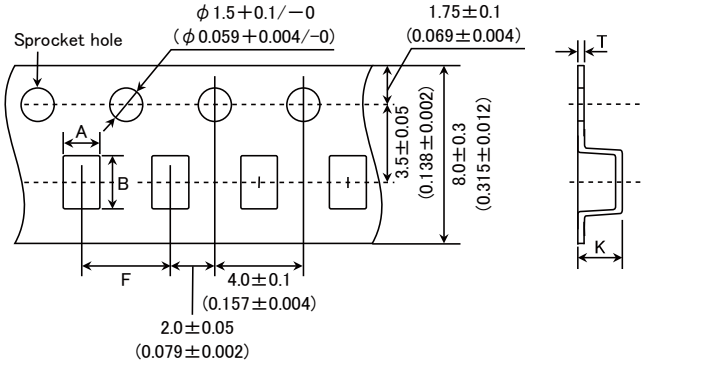

Type	Thickness mm (inch)	Chip cavity		Insertion Pitch F	Tape Thickness	
					K	T
CK2125(0805)	1.25 (0.049)	1.5 ± 0.2 (0.059 ± 0.008)	2.3 ± 0.2 (0.091 ± 0.008)	4.0 ± 0.1 (0.157 ± 0.004)	2.0 (0.079)	0.3 (0.012)
CKS2125(0805)	1.25 (0.049)	1.5 ± 0.2 (0.059 ± 0.008)	2.3 ± 0.2 (0.091 ± 0.008)	4.0 ± 0.1 (0.157 ± 0.004)	2.0 (0.079)	0.3 (0.012)
CKP2012(0805)	0.9 (0.035)	1.55 ± 0.2 (0.061 ± 0.008)	2.3 ± 0.2 (0.091 ± 0.008)	4.0 ± 0.1 (0.157 ± 0.004)	1.3 (0.051)	0.3 (0.012)
CKP2016(0806)	0.9 (0.035)	1.8 ± 0.1 (0.071 ± 0.004)	2.2 ± 0.1 (0.087 ± 0.004)	4.0 ± 0.1 (0.157 ± 0.004)	1.3 (0.051)	0.25 (0.01)
CKP2520(1008)	0.7 (0.028)	2.3 ± 0.1 (0.091 ± 0.004)	2.8 ± 0.1 (0.110 ± 0.004)	4.0 ± 0.1 (0.157 ± 0.004)	1.4 (0.055)	0.3 (0.012)
	0.9 (0.035)				1.4 (0.055)	
	1.1 (0.043)				1.7 (0.067)	
	1.1 (0.043)				1.7 (0.067)	
LK2125(0805)	1.25 (0.049)	1.5 ± 0.2 (0.059 ± 0.008)	2.3 ± 0.2 (0.091 ± 0.008)	4.0 ± 0.1 (0.157 ± 0.004)	2.0 (0.079)	0.3 (0.012)
HK2125(0805)	0.85 (0.033)	1.5 ± 0.2 (0.059 ± 0.008)	2.3 ± 0.2 (0.091 ± 0.008)	4.0 ± 0.1 (0.157 ± 0.004)	1.5 (0.059)	0.3 (0.012)
	1.0 (0.039)				2.0 (0.079)	
BK2125(0805)	1.25 (0.049)	1.5 ± 0.2 (0.059 ± 0.008)	2.3 ± 0.2 (0.091 ± 0.008)	4.0 ± 0.1 (0.157 ± 0.004)	2.0 (0.079)	0.3 (0.012)
BK3216(1206)	0.8 (0.031)	1.9 ± 0.1 (0.075 ± 0.004)	3.5 ± 0.1 (0.138 ± 0.004)	4.0 ± 0.1 (0.157 ± 0.004)	1.4 (0.055)	0.3 (0.012)
MCF0806(0302)	0.4 (0.016)	0.75 ± 0.05 (0.030 ± 0.002)	0.95 ± 0.05 (0.037 ± 0.002)	2.0 ± 0.05 (0.079 ± 0.002)	0.55 (0.022)	0.3 (0.012)
MCF1210(0504)	0.55 (0.022)	1.15 ± 0.05 (0.045 ± 0.002)	1.40 ± 0.05 (0.055 ± 0.002)	4.0 ± 0.1 (0.157 ± 0.004)	0.65 (0.026)	0.3 (0.012)
MCF2010(0804)	0.45 (0.018)	1.1 ± 0.1 (0.043 ± 0.004)	2.3 ± 0.1 (0.091 ± 0.004)	4.0 ± 0.1 (0.157 ± 0.004)	0.85 (0.033)	0.3 (0.012)
MCKK1608(0603)	1.0 (0.039)	1.1 ± 0.1 (0.043 ± 0.004)	1.95 ± 0.1 (± 0.004)	4.0 ± 0.1 (0.157 ± 0.004)	1.4 (0.055)	0.25 (0.01)
MCKK2012(0805)	1.0 (0.039)	1.55 ± 0.2 (0.061 ± 0.008)	2.3 ± 0.2 (0.091 ± 0.008)	4.0 ± 0.1 (0.157 ± 0.004)	1.35 (0.053)	0.25 (0.010)

Unit : mm (inch)

④ LEADER AND BLANK PORTION

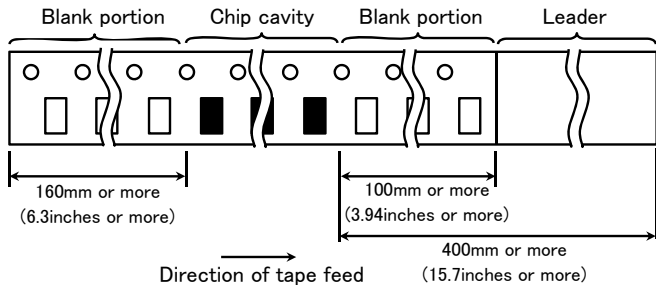

⑤ Reel Size

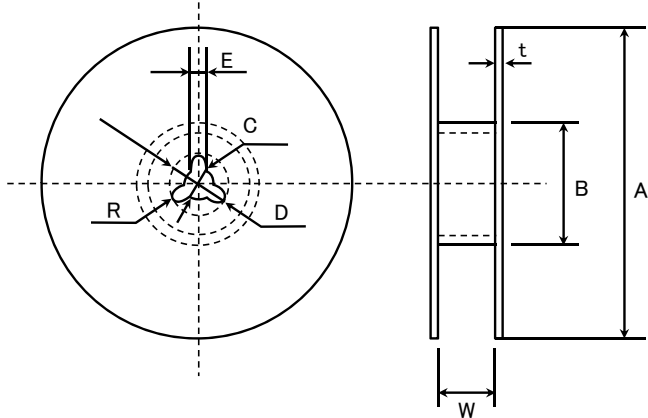

A	B	C	D	E	R
$\phi 178 \pm 2.0$	$\phi 60$ or more	$\phi 13.0 \pm 0.2$	$\phi 21.0 \pm 0.8$	2.0 ± 0.5	1.0

	t	W
4mm width tape	1.5max.	5 ± 1.0
8mm width tape	2.5max.	10 ± 1.5

(Unit : mm)

⑥ Top tape strength

The top tape requires a peel-off force of 0.1~0.7N in the direction of the arrow as illustrated below.

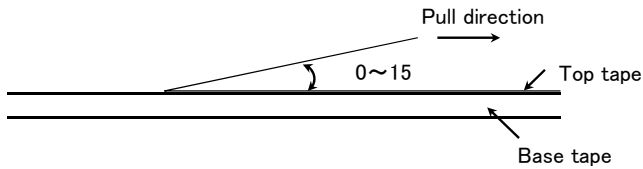

Multilayer chip inductors

Multilayer chip inductors for high frequency, Multilayer chip bead inductors

Multilayer common mode choke coils (MC series F type)

Metal Multilayer Chip Power Inductors (MCOIL™ MC series)

RELIABILITY DATA

1. Operating Temperature Range		
Specified Value	BK series	-55~+125°C
	BKH series	
	BKP series	-55~+85°C
	MCF series	-40~+85°C
	CK series	-40~+85°C
	CKS series	
	CKP series	
	LK series	
	HK0603, HK1005	-55~+125°C
	HK1608, HK2125	-40~+85°C
	HKQ0603	-55~+125°C
	AQ105	
MCOIL™ MC series	-40~+125°C (Including self-generated heat)	
2. Storage Temperature Range		
Specified Value	BK series	-55~+125°C
	BKH series	
	BKP series	-55~+85°C
	MCF series	-40~+85°C
	CK series	-40~+85°C
	CKS series	
	CKP series	
	LK series	
	HK0603, HK1005	-55~+125°C
	HK1608, HK2125	-40~+85°C
	HKQ0603	-55~+125°C
	AQ105	
MCOIL™ MC series	-40~+85°C	
3. Rated Current		
Specified Value	BK series	The temperature of the element is increased within 20°C.
	BKH series	
	BKP series	The temperature of the element is increased within 40°C
	MCF series	Refer to each specification.
	CK series	The temperature of the element is increased within 20°C.
	CKS series	
	CKP series	
	LK series	
	HK0603, HK1005	The decreasing-rate of inductance value is within 5 %
	HK1608, HK2125	
	HKQ0603	
	AQ105	
MCOIL™ MC series	Idc1: The decreasing-rate of inductance value is within 30 % Idc2: The temperature of the element is increased within 40°C	

4. Impedance		
Specified Value	BK series	Refer to each specification.
	BKH series	
	BKP series	
	MCF series	
Test Methods and Remarks	BK0603Series, BKP0603Series, BKH Series	Measuring frequency : 100±1MHz Measuring equipment : 4991A (or its equivalent) Measuring jig : 16193A (or its equivalent)
	BK1005Series, BKP1005Series, BKH1005Series	Measuring frequency : 100±1MHz Measuring equipment : 4291A (or its equivalent) Measuring jig : 16192A (or its equivalent), HW:16193A (or its equivalent)
	BK1608・2125Series, BKP1608・2125Series	Measuring frequency : 100±1MHz Measuring equipment : 4291A (or its equivalent), 4195A (or its equivalent) Measuring jig : 16092A (or its equivalent), HW:16192A (or its equivalent)
	BK2010・3216Series	Measuring frequency : 100±1MHz Measuring equipment : 4291A (or its equivalent), 4195A (or its equivalent) Measuring jig : 16192A (or its equivalent)
	MCF Series	Measuring frequency : 100±1MHz Measuring equipment : 4291A (or its equivalent)

5. Inductance		
Specified Value	CK series	Refer to each specification.
	CKS series	
	CKP series	
	LK series	
	HK0603, HK1005	
	HK1608, HK2125	
	HKQ0603	
	AQ105	
MCOIL™ MC series		
Test Methods and Remarks	CK, CKS, LK Series	Measuring frequency : Refer to each specification. Measuring equipment /jig : 1608,2125 4194A+16085B+16092A (or its equivalent), 4195A+41951+16092A (or its equivalent) 1005 4291A+16193A (or its equivalent) Measuring current : 047~4.7 μH 1mArms, 5.6~33 μH 0.1mArms
	CKP, MCOIL™ MC Series	Measuring frequency : 1MHz Measuring equipment : 4285A (or its equivalent)
	HK0603, HK1005, AQ Series	Measuring frequency : 100MHz Measuring equipment /jig : HK0603・AQ105 4291A+16197A (or its equivalent) HK1005 4291A+16193A (or its equivalent)
	HK1608, HK2125 Series	Measuring frequency : ~100nH 100MHz, 120nH~ 50MHz Measuring equipment /jig : 4195A+16092A (or its equivalent)
	HKQ Series	Measuring frequency : HKQ0603S・HKQ0603U 500MHz Measuring frequency : HKQ0603W 300/500MHz Measuring equipment /jig : E4991A+16197A (or its equivalent)

6. Q		
Specified Value	CK series	—
	CKS series	
	CKP series	
	LK series	
	HK0603, HK1005	
	HK1608, HK2125	
	HKQ0603	
	AQ105	
MCOIL™ MC series	—	
Test Methods and Remarks	LK Series	Measuring frequency : Refer to each specification.
		Measuring equipment /jig : 1608,2125 4194A+16085B+16092A (or its equivalent) 、4195A+41951+16092A (or its equivalent) 1005 4291A+16193A (or its equivalent)
		Measuring current : 047~4.7 μH 1mArms 、5.6~33 μH 0.1mArms
	HK0603, HK1005, AQ Series	Measuring frequency : 100MHz
		Measuring equipment /jig : HK0603・AQ105 4291A+16197A (or its equivalent) HK1005 4291A+16193A (or its equivalent)
	HK1608, HK2125 Series	Measuring frequency : ~100nH 100MHz 、120nH~ 50MHz
		Measuring equipment /jig : 4195A+16092A (or its equivalent)
	HKQ Series	Measuring frequency : HKQ0603S・HKQ0603U 500MHz
		Measuring frequency : HKQ0603W 300/500MHz
		Measuring equipment /jig : E4991A+16197A (or its equivalent)
7. DC Resistance		
Specified Value	BK series	Refer to each specification.
	BKH series	
	BKP series	
	MCF series	
	CK series	
	CKS series	
	CKP series	
	LK series	
	HK0603, HK1005	
	HK1608, HK2125	
	HKQ0603	
	AQ105	
MCOIL™ MC series	—	
Test Methods and Remarks	Measuring equipment: VOAC-7412, VOAC-7512, VOAC-7521 (made by Iwasaki Tsushinki), HIOKI3227 (or its equivalent)	
8. Self Resonance Frequency (SRF)		
Specified Value	BK series	—
	BKH series	
	BKP series	
	MCF series	
	CK series	
	CKS series	
	CKP series	
	LK series	
	HK0603, HK1005	
	HK1608, HK2125	
	HKQ0603	
	AQ105	
MCOIL™ MC series	—	
Test Methods and Remarks	LK, CK Series :	Measuring equipment : 4195A (or its equivalent)
		Measuring jig : 41951 + 16092A (or its equivalent)
	HK, HKQ, AQ Series :	Measuring equipment : 8719C (or its equivalent) ・8753D (or its equivalent) /HK2125

9. Temperature Characteristic		
Specified Value	BK series	—
	BKH series	
	BKP series	
	MCF series	
	CK series	
	CKS series	
	CKP series	
	LK series	
	HK0603, HK1005	
	HK1608, HK2125	
	HKQ0603	
	AQ105	
	MCOIL™ MC series	
	HK0603, HK1005	
HK1608, HK2125		
HKQ0603	Inductance change: Within $\pm 15\%$	
AQ105		
MCOIL™ MC series		
Test Methods and Remarks	HK, HKQ, AQ Series:	
	Temperature range	: $-30 \sim +85^{\circ}\text{C}$
	Reference temperature	: $+20^{\circ}\text{C}$
	MCOIL™ MC series:	
Temperature range	: $-40 \sim +85^{\circ}\text{C}$	
Reference temperature	: $+20^{\circ}\text{C}$	

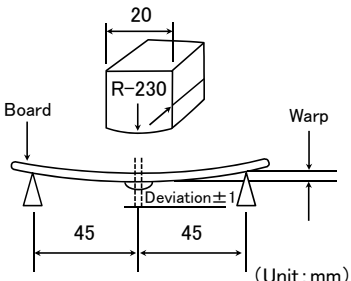
10. Resistance to Flexure of Substrate		
Specified Value	BK series	No mechanical damage.
	BKH series	
	BKP series	
	MCF series	
	CK series	
	CKS series	
	CKP series	
	LK series	
	HK0603, HK1005	
	HK1608, HK2125	
	HKQ0603	
	AQ105	
	MCOIL™ MC series	
	Test Methods and Remarks	
Testing board		: glass epoxy-resin substrate
Thickness		: 0.8mm
		 <p>(Unit: mm)</p>

11. Solderability		
Specified Value	BK series	At least 90% of terminal electrode is covered by new solder.
	BKH series	
	BKP series	
	MCF series	
	CK series	
	CKS series	
	CKP series	
	LK series	
	HK0603, HK1005	
	HK1608, HK2125	
	HKQ0603	
	AQ105	
	MCOIL™ MC series	
	Test Methods and Remarks	
Solder temperature		: $245 \pm 3^{\circ}\text{C}$ (Sn/3.0Ag/0.5Cu)
Duration		: 4 ± 1 sec.

This catalog contains the typical specification only due to the limitation of space. When you consider the purchase of our products, please check our specification. For details of each product (characteristics graph, reliability information, precautions for use, and so on), see our Web site (<http://www.ty-top.com/>).

12. Resistance to Soldering		
Specified Value	BK series	Appearance: No significant abnormality Impedance change: Within $\pm 30\%$
	BKH series	
	BKP series	
	MCF series	Appearance: No significant abnormality Impedance change: Within $\pm 20\%$
	CK series	Appearance: No significant abnormality Inductance change: R10~4R7 Within $\pm 10\%$, 6R8~100 Within $\pm 15\%$
	CKS series	Appearance: No significant abnormality Inductance change: Within $\pm 20\%$
	CKP series	Appearance: No significant abnormality Inductance change: Within $\pm 30\%$
	LK series	Appearance: No significant abnormality Inductance change: 1005 Within $\pm 15\%$ 1608,2125 47N~4R7: Within $\pm 10\%$ 5R6~330: Within $\pm 15\%$
	HK0603, HK1005	Appearance: No significant abnormality Inductance change: Within $\pm 5\%$
	HK1608, HK2125	
	HKQ0603	
AQ105		
MCOIL™ MC series	Appearance: No significant abnormality Inductance change: Within $\pm 10\%$	
Test Methods and Remarks	Solder temperature	: $260 \pm 5^\circ\text{C}$
	Duration	: 10 ± 0.5 sec.
	Preheating temperature	: 150 to 180°C
	Preheating time	: 3 min.
	Flux	: Immersion into methanol solution with colophony for 3 to 5 sec.
	Recovery	: 2 to 3 hrs of recovery under the standard condition after the test. (See Note 1)

(Note 1) When there are questions concerning measurement result measurement shall be made after 48 ± 2 hrs of recovery under the standard condition.

13. Thermal Shock			
Specified Value	BK series	Appearance: No significant abnormality Impedance change: Within $\pm 30\%$	
	BKH series		
	BKP series		
	MCF series	Appearance: No significant abnormality Impedance change: Within $\pm 20\%$	
	CK series	Appearance: No significant abnormality Inductance change: Within $\pm 20\%$	
	CKS series	Appearance: No significant abnormality Inductance change: Within $\pm 20\%$	
	CKP series	Appearance: No significant abnormality Inductance change: Within $\pm 30\%$	
	LK series	Appearance: No significant abnormality Inductance change: Within $\pm 10\%$ Q change: Within $\pm 30\%$	
	HK0603, HK1005	Appearance: No significant abnormality Inductance change: Within $\pm 10\%$ Q change: Within $\pm 20\%$	
	HK1608, HK2125		
	HKQ0603		
AQ105			
MCOIL™ MC series	Appearance: No significant abnormality Inductance change: Within $\pm 10\%$		
Test Methods and Remarks	Conditions for 1 cycle		
	Step	temperature ($^\circ\text{C}$)	time (min.)
	1	Minimum operating temperature $+0/-3$	30 ± 3
	2	Room temperature	$2 \sim 3$
	3	Maximum operating temperature $+3/-0$	30 ± 3
	4	Room temperature	$2 \sim 3$
Number of cycles: 5			
Recovery: 2 to 3 hrs of recovery under the standard condition after the test. (See Note 1)			

(Note 1) When there are questions concerning measurement result measurement shall be made after 48 ± 2 hrs of recovery under the standard condition.

14. Damp Heat (Steady state)		
Specified Value	BK series	Appearance: No significant abnormality Impedance change: Within $\pm 30\%$
	BKH series	
	BKP series	
	MCF series	Appearance: No significant abnormality Impedance change: Within $\pm 20\%$
	CK series	Appearance: No significant abnormality Inductance change: Within $\pm 20\%$
	CKS series	
	CKP series	Appearance: No significant abnormality Inductance change: Within $\pm 30\%$
	LK series	Appearance: No significant abnormality Inductance change: 1005,1608 Within $\pm 10\%$ 2125 Within $\pm 20\%$ Q change: Within $\pm 30\%$
	HK0603, HK1005	Appearance: No significant abnormality Inductance change: Within $\pm 10\%$ Q change: Within $\pm 20\%$
	HK1608, HK2125	
	HKQ0603	
	AQ105	
MCOIL™ MC series	Appearance: No significant abnormality Inductance change: Within $\pm 10\%$	
Test Methods and Remarks	BK, BKP, BKH, LK, CK, CKS, CKP, MCF Series: Temperature : $40 \pm 2^\circ\text{C}$ Humidity : 90 to 95%RH Duration : 500 +24/-0 hrs Recovery : 2 to 3 hrs of recovery under the standard condition after the removal from test chamber. (See Note 1) HK, HKQ, AQ, MCOIL™ MC series: Temperature : $60 \pm 2^\circ\text{C}$ Humidity : 90 to 95%RH Duration : 500 +24/-0 hrs Recovery : 2 to 3 hrs of recovery under the standard condition after the removal from test chamber. (See Note 1)	

(Note 1) When there are questions concerning measurement result measurement shall be made after 48 ± 2 hrs of recovery under the standard condition.

15. Loading under Damp Heat		
Specified Value	BK series	Appearance: No significant abnormality Impedance change: Within $\pm 30\%$
	BKH series	
	BKP series	
	MCF series	—
	CK series	Appearance: No significant abnormality Inductance change: Within $\pm 20\%$
	CKS series	
	CKP series	Appearance: No significant abnormality Inductance change: Within $\pm 30\%$
	LK series	Appearance: No significant abnormality Inductance change: 1005 Within $\pm 10\%$ 1608 0.047~12.0 μH : Within $\pm 10\%$ 15.0~33.0 μH : Within $\pm 15\%$ 2125 Within $\pm 20\%$ Q change: Within $\pm 30\%$
	HK0603, HK1005	Appearance: No significant abnormality Inductance change: Within $\pm 10\%$ Q change: Within $\pm 20\%$
	HK1608, HK2125	
	HKQ0603	
	AQ105	
MCOIL™ MC series※	Appearance: No significant abnormality Inductance change: Within $\pm 10\%$	
Test Methods and Remarks	BK, BKP, BKH, LK, CK, CKS, CKP Series: Temperature : $40 \pm 2^\circ\text{C}$ Humidity : 90 to 95%RH Applied current : Rated current Duration : 500 +24/-0 hrs Recovery : 2 to 3 hrs of recovery under the standard condition after the removal from test chamber. (See Note 1) HK, HKQ, AQ, MCOIL™ MC Series: Temperature : $60 \pm 2^\circ\text{C}$ Humidity : 90 to 95%RH Applied current : Rated current ※MC series I_{dc2max} Duration : 500 +24/-0 hrs Recovery : 2 to 3 hrs of recovery under the standard condition after the removal from test chamber. (See Note 1)	

Note on standard condition: standard condition referred to h_{min} is defined as follows:

5 to 35°C of temperature, 45 to 85% relative humidity, and 86 to 106kPa of air pressure.

When there are questions concerning measurement results:

In order to provide correlation data, the test shall be conducted under condition of $20 \pm 2^\circ\text{C}$ of temperature, 60 to 70% relative humidity, and 86 to 106kPa of air pressure.

Unless otherwise specified, all the tests are conducted under the standard condition.

(Note 1) Measurement shall be made after 48 ± 2 hrs of recovery under the standard condition.

16. Loading at High Temperature		
Specified Value	BK series	Appearance: No significant abnormality Impedance change: Within $\pm 30\%$
	BKH series	
	BKP series	
	MCF series	Appearance: No significant abnormality Impedance change: Within $\pm 20\%$
	CK series	Appearance: No significant abnormality
	CKS series	Inductance change: Within $\pm 20\%$
	CKP series	Appearance: No significant abnormality Inductance change: Within $\pm 30\%$
	LK series	Appearance: No significant abnormality Inductance change: 1005 Within $\pm 10\%$ 1608 0.047~12.0 μH : Within $\pm 10\%$ 15.0~33.0 μH : Within $\pm 15\%$ 2125 Within $\pm 20\%$ Q change: Within $\pm 30\%$
	HK0603, HK1005	Appearance: No significant abnormality Inductance change: Within $\pm 10\%$ Q change: Within $\pm 20\%$
	HK1608, HK2125	
	HKQ0603	
	AQ105	
	MCOIL™ MC series※	Appearance: No significant abnormality Inductance change: Within $\pm 10\%$
Test Methods and Remarks	Temperature : Maximum operating temperature Applied current : Rated current ※MC series I_{dc2max} Duration : 500 +24/-0 hrs Recovery : 2 to 3 hrs of recovery under the standard condition after the removal from test chamber. (See Note 1)	

Note on standard condition: standard condition referred to herein is defined as follows:
5 to 35°C of temperature, 45 to 85% relative humidity, and 86 to 106kPa of air pressure.

When there are questions concerning measurement results:

In order to provide correlation data, the test shall be conducted under condition of 20±2°C of temperature, 60 to 70% relative humidity, and 86 to 106kPa of air pressure. Unless otherwise specified, all the tests are conducted under the standard condition.

(Note 1) Measurement shall be made after 48±2 hrs of recovery under the standard condition.

Precautions on the use of Multilayer chip inductors

Multilayer chip inductors for high frequency, Multilayer chip bead inductors

Multilayer common mode choke coils (MC series F type)

■ PRECAUTIONS

1. Circuit Design

Precautions	<p>Verification of operating environment, electrical rating and performance</p> <p>1. A malfunction in medical equipment, spacecraft, nuclear reactors, etc. may cause serious harm to human life or have severe social ramifications.</p> <p>As such, any inductors to be used in such equipment may require higher safety and/or reliability considerations and should be clearly differentiated from components used in general purpose applications.</p> <p>Operating Current (Verification of Rated current)</p> <p>1. The operating current including inrush current for inductors must always be lower than their rated values.</p> <p>2. Do not apply current in excess of the rated value because the inductance may be reduced due to the magnetic saturation effect.</p>
-------------	---

2. PCB Design

Precautions	<p>Pattern configurations (Design of Land-patterns)</p> <p>1. When inductors are mounted on a PCB, the size of land patterns and the amount of solder used (size of fillet) can directly affect inductor performance.</p> <p>Therefore, the following items must be carefully considered in the design of solder land patterns:</p> <p>(1) The amount of solder applied can affect the ability of chips to withstand mechanical stresses which may lead to breaking or cracking. Therefore, when designing land-patterns it is necessary to consider the appropriate size and configuration of the solder pads which in turn determines the amount of solder necessary to form the fillets.</p> <p>(2) When more than one part is jointly soldered onto the same land or pad, the pad must be designed so that each component's soldering point is separated by solder-resist.</p> <p>(3) The larger size of land patterns and amount of solder, the smaller Q value after mounting on PCB. It makes higher the Q value to design land patterns smaller than terminal electrode of chips.</p> <p>Pattern configurations (Inductor layout on panelized [breakaway] PC boards)</p> <p>1. After inductors have been mounted on the boards, chips can be subjected to mechanical stresses in subsequent manufacturing processes (PCB cutting, board inspection, mounting of additional parts, assembly into the chassis, wave soldering the reflow soldered boards etc.) For this reason, planning pattern configurations and the position of SMD inductors should be carefully performed to minimize stress.</p>
-------------	---

Technical considerations	<p>Pattern configurations (Design of Land-patterns)</p> <p>1. The following diagrams and tables show some examples of recommended patterns to prevent excessive solder amounts (larger fillets which extend above the component end terminations). Examples of improper pattern designs are also shown.</p> <p>(1) Recommended land dimensions for a typical chip inductor land patterns for PCBs</p>
--------------------------	---

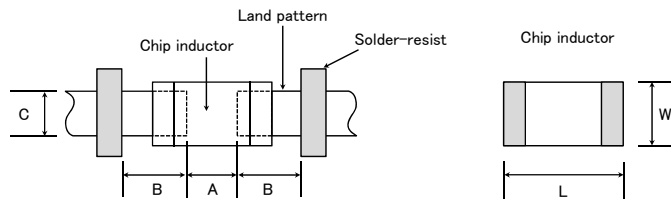

Recommended land dimensions for wave-soldering (Unit: mm)

Type	1608	2012	2125	2016	2520	3216	
Size	L	1.6	2.0	2.0	2.0	2.5	3.2
	W	0.8	1.25	1.25	1.6	2.0	1.6
A	0.8~1.0	1.0~1.4	1.0~1.4	1.0~1.4	1.0~1.4	1.8~2.5	
B	0.5~0.8	0.8~1.5	0.8~1.5	0.8~1.5	0.6~1.0	0.8~1.7	
C	0.6~0.8	0.9~1.2	0.9~1.2	1.3~1.6	1.6~2.0	1.2~1.6	

Recommended land dimensions for reflow-soldering (Unit: mm)

Type	0603	1005	105	1608	2012	2125	2016	2520	3216
Size	L	0.6	1.0	1.0	1.6	2.0	2.0	2.5	3.2
	W	0.3	0.5	0.6	0.8	1.25	1.25	1.6	2.0
A	0.20~0.30	0.45~0.55	0.50~0.55	0.8~1.0	0.8~1.2	0.8~1.2	0.8~1.2	1.0~1.4	1.8~2.5
B	0.20~0.30	0.40~0.50	0.30~0.40	0.6~0.8	0.8~1.2	0.8~1.2	0.8~1.2	0.6~1.0	0.6~1.5
C	0.25~0.40	0.45~0.55	0.60~0.70	0.6~0.8	0.9~1.6	0.9~1.6	1.2~2.0	1.8~2.2	1.2~2.0

This catalog contains the typical specification only due to the limitation of space. When you consider the purchase of our products, please check our specification. For details of each product (characteristics graph, reliability information, precautions for use, and so on), see our Web site (<http://www.ty-top.com/>).

Excess solder can affect the ability of chips to withstand mechanical stresses. Therefore, please take proper precautions when designing land-patterns.

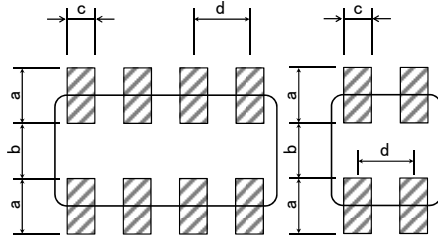

Recommended land dimension for Reflow-soldering

Type	3216	2010	1210	0806	0605	
Size	L	3.2	2.0	1.25	0.85	0.65
	W	1.6	1.0	1.0	0.65	0.50
a	0.7~0.9	0.5~0.6	0.45~0.55	0.25~0.35	0.27~0.33	
b	0.8~1.0	0.5~0.6	0.7~0.8	0.25~0.35	0.17~0.23	
c	0.4~0.5	0.2~0.3	0.25~0.35	0.25~0.35	0.20~0.26	
d	0.8	0.5	0.55	0.5	0.4	

(Unit: mm)

(2) Examples of good and bad solder application

Item	Not recommended	Recommended
Mixed mounting of SMD and leaded components	Lead wire of component	Solder-resist
Component placement close to the chassis	Chassis Solder (for grounding) Electrode pattern	Solder-resist
Hand-soldering of leaded components near mounted components	Lead wire of component Soldering iron	Solder-resist
Horizontal component placement	Solder-resist	Solder-resist

Pattern configurations (Inductor layout on panelized [breakaway] PC boards)

1-1. The following are examples of good and bad inductor layout. SMD inductors should be located to minimize any possible mechanical stresses from board warp or deflection.

Item	Not recommended	Recommended
Deflection of the board	Solder-resist	Solder-resist Position the component at a right angle to the direction of the mechanical stresses that are anticipated.

1-2. To layout the inductors for the breakaway PC board, it should be noted that the amount of mechanical stresses given will vary depending on inductor layout.

An example below should be counted for better design.

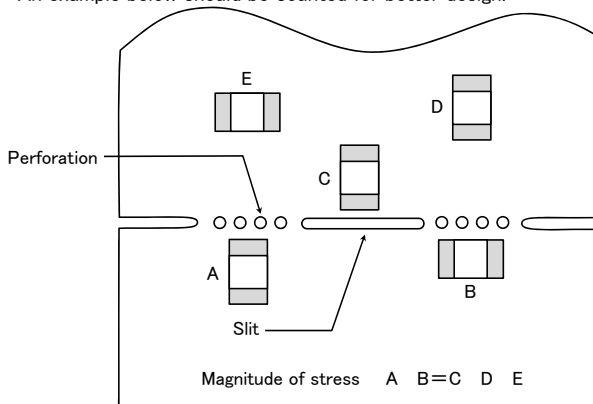

1-3. When breaking PC boards along their perforations, the amount of mechanical stress on the inductors can vary according to the method used. The following methods are listed in order from least stressful to most stressful: push-back, slit, V-grooving, and perforation. Thus, any ideal SMD inductor layout must also consider the PCB splitting procedure.

3. Considerations for automatic placement

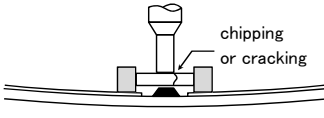
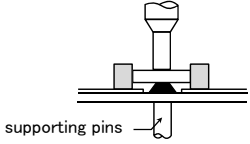
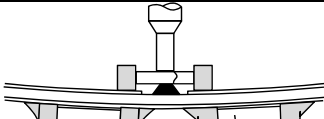
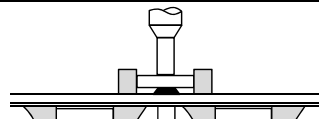
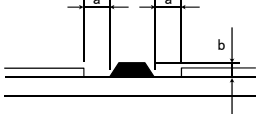
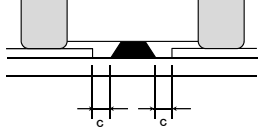
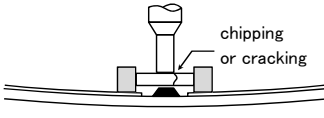
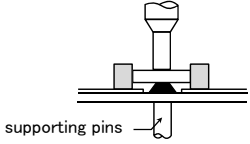
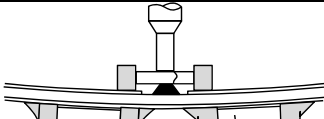
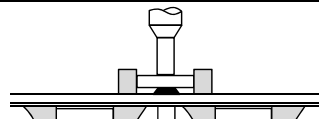
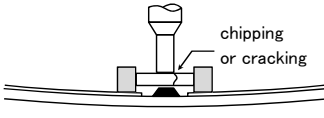
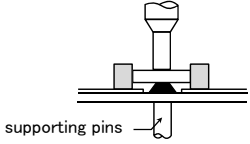
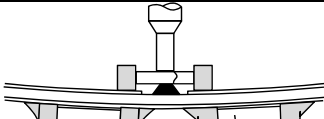
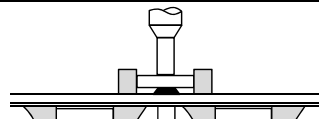
<p>Precautions</p>	<p>Adjustment of mounting machine</p> <ol style="list-style-type: none"> Excessive impact load should not be imposed on the inductors when mounting onto the PC boards. The maintenance and inspection of the mounter should be conducted periodically. <p>Selection of Adhesives</p> <ol style="list-style-type: none"> Mounting inductors with adhesives in preliminary assembly, before the soldering stage, may lead to degraded inductor characteristics unless the following factors are appropriately checked the size of land patterns, type of adhesive, amount applied, hardening temperature and hardening period. Therefore, it is imperative to consult the manufacturer of the adhesives on proper usage and amounts of adhesive to use. 																	
<p>Technical considerations</p>	<p>Adjustment of mounting machine</p> <ol style="list-style-type: none"> If the lower limit of the pick-up nozzle is low, too much force may be imposed on the inductors, causing damage. To avoid this, the following points should be considered before lowering the pick-up nozzle: <ol style="list-style-type: none"> The lower limit of the pick-up nozzle should be adjusted to the surface level of the PC board after correcting for deflection of the board. The pick-up pressure should be adjusted between 1 and 3N static loads. To reduce the amount of deflection of the board caused by impact of the pick-up nozzle, supporting pins or back-up pins should be used under the PC board. The following diagrams show some typical examples of good pick-up nozzle placement: <table border="1" data-bbox="331 566 1437 963"> <thead> <tr> <th>Item</th> <th>Improper method</th> <th>Proper method</th> </tr> </thead> <tbody> <tr> <td>Single-sided mounting</td> <td></td> <td></td> </tr> <tr> <td>Double-sided mounting</td> <td></td> <td></td> </tr> </tbody> </table> <ol style="list-style-type: none"> As the alignment pin wears out, adjustment of the nozzle height can cause chipping or cracking of the inductors because of mechanical impact on the inductors. To avoid this, the monitoring of the width between the alignment pin in the stopped position, and maintenance, inspection and replacement of the pin should be conducted periodically. <p>Selection of Adhesives</p> <ol style="list-style-type: none"> Some adhesives may cause reduced insulation resistance. The difference between the shrinkage percentage of the adhesive and that of the inductors may result in stresses on the inductors and lead to cracking. Moreover, too little or too much adhesive applied to the board may adversely affect component placement, so the following precautions should be noted in the application of adhesives. <ol style="list-style-type: none"> Required adhesive characteristics <ol style="list-style-type: none"> The adhesive should be strong enough to hold parts on the board during the mounting & solder process. The adhesive should have sufficient strength at high temperatures. The adhesive should have good coating and thickness consistency. The adhesive should be used during its prescribed shelf life. The adhesive should harden rapidly. The adhesive must not be contaminated. The adhesive should have excellent insulation characteristics. The adhesive should not be toxic and have no emission of toxic gasses. When using adhesives to mount inductors on a PCB, inappropriate amounts of adhesive on the board may adversely affect component placement. Too little adhesive may cause the inductors to fall off the board during the solder process. Too much adhesive may cause defective soldering due excessive flow of adhesive on to the land or solder pad. <p>[Recommended conditions]</p> <table border="1" data-bbox="347 1541 805 1659"> <thead> <tr> <th>Figure</th> <th>0805 case sizes as examples</th> </tr> </thead> <tbody> <tr> <td>a</td> <td>0.3mm min</td> </tr> <tr> <td>b</td> <td>100~120 μm</td> </tr> <tr> <td>c</td> <td>Area with no adhesive</td> </tr> </tbody> </table> <div style="display: flex; justify-content: space-around; align-items: flex-end;"> <div data-bbox="869 1518 1125 1668"> <p>Amount of adhesives</p>  </div> <div data-bbox="1209 1518 1476 1686"> <p>After inductors are bonded</p>  </div> </div>	Item	Improper method	Proper method	Single-sided mounting			Double-sided mounting			Figure	0805 case sizes as examples	a	0.3mm min	b	100~120 μm	c	Area with no adhesive
Item	Improper method	Proper method																
Single-sided mounting																		
Double-sided mounting																		
Figure	0805 case sizes as examples																	
a	0.3mm min																	
b	100~120 μm																	
c	Area with no adhesive																	

4. Soldering

<p>Precautions</p>	<p>Selection of Flux</p> <ol style="list-style-type: none"> Since flux may have a significant effect on the performance of inductors, it is necessary to verify the following conditions prior to use <ol style="list-style-type: none"> Flux used should be with less than or equal to 0.1 wt% (Chlorine conversion method) of halogenated content. Flux having a strong acidity content should not be applied. When soldering inductors on the board, the amount of flux applied should be controlled at the optimum level. When using water-soluble flux, special care should be taken to properly clean the boards. <p>Soldering</p> <ol style="list-style-type: none"> Temperature, time, amount of solder, etc. are specified in accordance with the following recommended conditions, and please contact us about peak temperature when you use lead-free paste.
--------------------	---

Selection of Flux

- 1-1. When too much halogenated substance (Chlorine, etc.) content is used to activate the flux, or highly acidic flux is used, an excessive amount of residue after soldering may lead to corrosion of the terminal electrodes or degradation of insulation resistance on the surface of the Inductor.
- 1-2. Flux is used to increase solderability in flow soldering, but if too much is applied, a large amount of flux gas may be emitted and may detrimentally affect solderability. To minimize the amount of flux applied, it is recommended to use a flux-bubbling system.
- 1-3. Since the residue of water-soluble flux is easily dissolved by water content in the air, the residue on the surface of Inductor in high humidity conditions may cause a degradation of insulation resistance and therefore affect the reliability of the components. The cleaning methods and the capability of the machines used should also be considered carefully when selecting water-soluble flux.

Soldering

1-1. Preheating when soldering

Heating: Chip inductor components should be preheated to within 100 to 130°C of the soldering. **Cooling:** The temperature difference between the components and cleaning process should not be greater than 100°C.

Chip inductors are susceptible to thermal shock when exposed to rapid or concentrated heating or rapid cooling. Therefore, the soldering process must be conducted with a great care so as to prevent malfunction of the components due to excessive thermal shock.

[Reflow soldering]

【Recommended conditions for eutectic soldering】

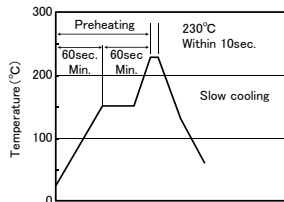

【Recommended condition for Pb-free soldering】

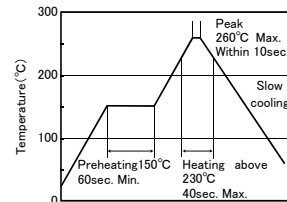

※Ceramic chip components should be preheated to within 100 to 130°C of the soldering.

※Assured to be reflow soldering for 2 times.

※MC series Peak 230°C (eutectic soldering), 260°C (Pb-free soldering) max within 5sec.

Caution

1. The ideal condition is to have solder mass (fillet) controlled to 1/2 to 1/3 of the thickness of the inductor, as shown below:

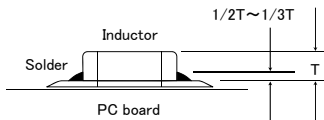

2. Because excessive dwell times can detrimentally affect solderability, soldering duration should be kept as close to recommended times as possible.

[Wave soldering]

【Recommended conditions for eutectic soldering】

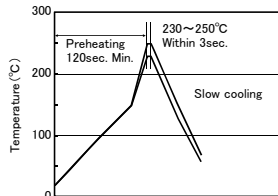

【Recommended condition for Pb-free soldering】

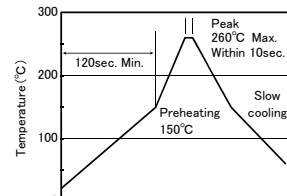

※Ceramic chip components should be preheated to within 100 to 130°C of the soldering.

※Assured to be wave soldering for 1 time.

※Except for reflow soldering type.

Caution

1. Make sure the inductors are preheated sufficiently.
2. The temperature difference between the inductor and melted solder should not be greater than 100 to 130°C.
3. Cooling after soldering should be as gradual as possible.
4. Wave soldering must not be applied to the inductors designated as for reflow soldering only.

[Hand soldering]

【Recommended conditions for eutectic soldering】

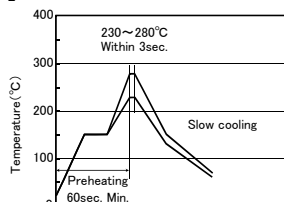

【Recommended condition for Pb-free soldering】

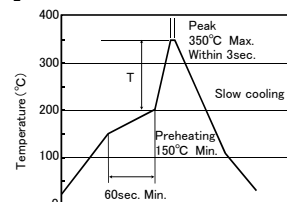

(※ $T \leq 190^\circ\text{C}$ (3216 Type max), $T \leq 130^\circ\text{C}$ (3225 Type min))

※It is recommended to use 20W soldering iron and the tip is 1φ or less.

※The soldering iron should not directly touch the components.

※Assured to be soldering iron for 1 time.

Note: The above profiles are the maximum allowable soldering condition, therefore these profiles are not always recommended.

Technical considerations

	<p>Caution</p> <ol style="list-style-type: none"> 1. Use a 20W soldering iron with a maximum tip diameter of 1.0 mm. 2. The soldering iron should not directly touch the inductor. 						
5. Cleaning							
Precautions	<p>Cleaning conditions</p> <ol style="list-style-type: none"> 1. When cleaning the PC board after the Inductors are all mounted, select the appropriate cleaning solution according to the type of flux used and purpose of the cleaning (e.g. to remove soldering flux or other materials from the production process.) 2. Cleaning conditions should be determined after verifying, through a test run, that the cleaning process does not affect the inductor's characteristics. 						
Technical considerations	<p>Cleaning conditions</p> <ol style="list-style-type: none"> 1. The use of inappropriate solutions can cause foreign substances such as flux residue to adhere to the inductor, resulting in a degradation of the inductor's electrical properties (especially insulation resistance). 2. Inappropriate cleaning conditions (insufficient or excessive cleaning) may detrimentally affect the performance of the inductors. <ol style="list-style-type: none"> (1) Excessive cleaning <ol style="list-style-type: none"> a. In the case of ultrasonic cleaning, too much power output can cause excessive vibration of the PC board which may lead to the cracking of the inductor or the soldered portion, or decrease the terminal electrodes' strength. Thus the following conditions should be carefully checked <table border="0" style="margin-left: 40px;"> <tr> <td>Ultrasonic output</td> <td>Below 20W/</td> </tr> <tr> <td>Ultrasonic frequency</td> <td>Below 40kHz</td> </tr> <tr> <td>Ultrasonic washing period</td> <td>5 min. or less</td> </tr> </table> 	Ultrasonic output	Below 20W/	Ultrasonic frequency	Below 40kHz	Ultrasonic washing period	5 min. or less
Ultrasonic output	Below 20W/						
Ultrasonic frequency	Below 40kHz						
Ultrasonic washing period	5 min. or less						
6. Post cleaning processes							
Precautions	<p>Application of resin coatings, moldings, etc. to the PCB and components.</p> <ol style="list-style-type: none"> 1. With some type of resins a decomposition gas or chemical reaction vapor may remain inside the resin during the hardening period or while left under normal storage conditions resulting in the deterioration of the inductor's performance. 2. When a resin's hardening temperature is higher than the inductor's operating temperature, the stresses generated by the excess heat may lead to inductor damage or destruction. 3. Stress caused by a resin's temperature generated expansion and contraction may damage inductors. <p>The use of such resins, molding materials etc. is not recommended.</p>						
7. Handling							
Precautions	<p>Breakaway PC boards (splitting along perforations)</p> <ol style="list-style-type: none"> 1. When splitting the PC board after mounting inductors and other components, care is required so as not to give any stresses of deflection or twisting to the board. 2. Board separation should not be done manually, but by using the appropriate devices. <p>General handling precautions</p> <ol style="list-style-type: none"> 1. Always wear static control bands to protect against ESD. 2. Keep the inductors away from all magnets and magnetic objects. 3. Use non-magnetic tweezers when handling inductors. 4. Any devices used with the inductors (soldering irons, measuring instruments) should be properly grounded. 5. Keep bare hands and metal products (i.e., metal desk) away from chip electrodes or conductive areas that lead to chip electrodes. 6. Keep inductors away from items that generate magnetic fields such as speakers or coils. <p>Mechanical considerations</p> <ol style="list-style-type: none"> 1. Be careful not to subject the inductors to excessive mechanical shocks. <ol style="list-style-type: none"> (1) If inductors are dropped on the floor or a hard surface they should not be used. (2) When handling the mounted boards, be careful that the mounted components do not come in contact with or bump against other boards or components. 						
8. Storage conditions							
Precautions	<p>Storage</p> <ol style="list-style-type: none"> 1. To maintain the solderability of terminal electrodes and to keep the packaging material in good condition, care must be taken to control temperature and humidity in the storage area. Humidity should especially be kept as low as possible. <ul style="list-style-type: none"> • Recommended conditions <table border="0" style="margin-left: 20px;"> <tr> <td>Ambient temperature: Below 30°C</td> <td>Humidity: Below 70% RH</td> </tr> </table> <p>The ambient temperature must be kept below 40°C. Even under ideal storage conditions, solderability of inductor is deteriorated as time passes, so inductors should be used within 6 months from the time of delivery.</p> <ul style="list-style-type: none"> • Inductor should be kept where no chlorine or sulfur exists in the air. 	Ambient temperature: Below 30°C	Humidity: Below 70% RH				
Ambient temperature: Below 30°C	Humidity: Below 70% RH						
Technical considerations	<p>Storage</p> <ol style="list-style-type: none"> 1. If the parts are stocked in a high temperature and humidity environment, problems such as reduced solderability caused by oxidation of terminal electrodes and deterioration of taping/packaging materials may take place. For this reason, components should be used within 6 months from the time of delivery. If exceeding the above period, please check solderability before using the inductors. 						