

Please read this notice before using the TAIYO YUDEN products.

REMINDERS

- Product information in this catalog is as of October 2018. All of the contents specified herein are subject to change without notice due to technical improvements, etc. Therefore, please check for the latest information carefully before practical application or use of our products.

Please note that TAIYO YUDEN shall not be in any way responsible for any damages and defects in products or equipment incorporating our products, which are caused under the conditions other than those specified in this catalog or individual product specification sheets.

- Please contact TAIYO YUDEN for further details of product specifications as the individual product specification sheets are available.
- Please conduct validation and verification of our products in actual condition of mounting and operating environment before using our products.
- The products listed in this catalog are intended for use in general electronic equipment (e.g., AV equipment, OA equipment, home electric appliances, office equipment, information and communication equipment including, without limitation, mobile phone, and PC) and medical equipment classified as Class I or II by IMDRF. Please be sure to contact TAIYO YUDEN for further information before using the products for any equipment which may directly cause loss of human life or bodily injury (e.g., transportation equipment including, without limitation, automotive powertrain control system, train control system, and ship control system, traffic signal equipment, disaster prevention equipment, medical equipment classified as Class III by IMDRF, highly public information network equipment including, without limitation, telephone exchange, and base station).

Please do not incorporate our products into any equipment requiring high levels of safety and/or reliability (e.g., aerospace equipment, aviation equipment*, medical equipment classified as Class IV by IMDRF, nuclear control equipment, undersea equipment, military equipment).

*Note: There is a possibility that our products can be used only for aviation equipment that does not directly affect the safe operation of aircraft (e.g., in-flight entertainment, cabin light, electric seat, cooking equipment) if such use meets requirements specified separately by TAIYO YUDEN. Please be sure to contact TAIYO YUDEN for further information before using our products for such aviation equipment.

When our products are used even for high safety and/or reliability-required devices or circuits of general electronic equipment, it is strongly recommended to perform a thorough safety evaluation prior to use of our products and to install a protection circuit as necessary.

Please note that unless you obtain prior written consent of TAIYO YUDEN, TAIYO YUDEN shall not be in any way responsible for any damages incurred by you or third parties arising from use of the products listed in this catalog for any equipment requiring inquiry to TAIYO YUDEN or prohibited for use by TAIYO YUDEN as described above.

- Information contained in this catalog is intended to convey examples of typical performances and/or applications of our products and is not intended to make any warranty with respect to the intellectual property rights or any other related rights of TAIYO YUDEN or any third parties nor grant any license under such rights.
- Please note that the scope of warranty for our products is limited to the delivered our products themselves and TAIYO YUDEN shall not be in any way responsible for any damages resulting from a fault or defect in our products. Notwithstanding the foregoing, if there is a written agreement (e.g., supply and purchase agreement, quality assurance agreement) signed by TAIYO YUDEN and your company, TAIYO YUDEN will warrant our products in accordance with such agreement.
- The contents of this catalog are applicable to our products which are purchased from our sales offices or authorized distributors (hereinafter "TAIYO YUDEN's official sales channel"). Please note that the contents of this catalog are not applicable to our products purchased from any seller other than TAIYO YUDEN's official sales channel.
- Caution for Export
Some of our products listed in this catalog may require specific procedures for export according to "U.S. Export Administration Regulations", "Foreign Exchange and Foreign Trade Control Law" of Japan, and other applicable regulations. Should you have any questions on this matter, please contact our sales staff.

WIRE-WOUND CHIP INDUCTORS (LB SERIES)

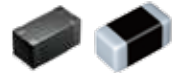

REFLOW

■ PARTS NUMBER

* Operating Temp.: -40~+105°C (Including self-generated heat)

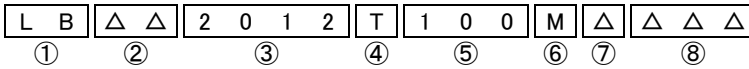

△=Blank space

① Series name

Code	Series name
LB	Wound chip inductor

④ Packaging

Code	Packaging
T	Taping

② Characteristics

Code	Characteristics
△△	Standard
△C	High current
△R	Low Rdc
MF	Low loss

⑤ Nominal inductance

Code (example)	Nominal inductance [μH]
1R0	1.0
100	10
101	100

※R=Decimal point

③ Dimensions (L × W)

Code	Type (inch)	Dimensions (L × W) [mm]
1608	1608 (0603)	1.6 × 0.8
2012	2012 (0805)	2.0 × 1.25
2016	2016 (0806)	2.0 × 1.6
2518	2518 (1007)	2.5 × 1.8
3218	3218 (1207)	3.2 × 1.8
3225	3225 (1210)	3.2 × 2.5

⑥ Inductance tolerance

Code	Inductance tolerance
K	±10%
M	±20%

⑦ Special code

Code	Special code
△	Standard
R	Low Rdc type

⑧ Internal code

■ STANDARD EXTERNAL DIMENSIONS / STANDARD QUANTITY

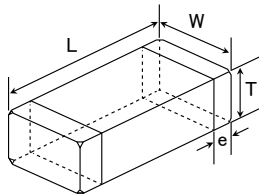

Recommended Land Patterns

Surface Mounting

- Mounting and soldering conditions should be checked beforehand.
- Applicable soldering process to these products is reflow soldering only.

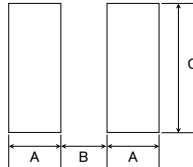

Type	A	B	C
1608	0.55	0.7	0.9
MF1608	0.55	0.7	1.0
2012	0.60	1.0	1.45
2016	0.60	1.0	1.8
2518	0.60	1.5	2.0
3218	0.85	1.7	2.0
3225	0.85	1.7	2.7

Unit : mm

Type	L	W	T	e	Standard quantity [pcs]	
					Paper tape	Embossed tape
LB 1608	1.6±0.1 (0.063±0.004)	0.8±0.1 (0.031±0.004)	0.8±0.1 (0.031±0.004)	0.35±0.15 (0.014±0.006)	4000	—
LBMF1608	1.6±0.2 (0.063±0.008)	0.8±0.2 (0.031±0.008)	0.8±0.2 (0.031±0.008)	0.45±0.15 (0.016±0.006)	—	3000
LB 2012 LB C2012 LB R2012	2.0±0.2 (0.079±0.008)	1.25±0.2 (0.049±0.008)	1.25±0.2 (0.049±0.008)	0.5±0.2 (0.020±0.008)	—	3000
LB 2016 LB C2016	2.0±0.2 (0.079±0.008)	1.6±0.2 (0.063±0.008)	1.6±0.2 (0.063±0.008)	0.5±0.2 (0.020±0.008)	—	2000
LB 2518 LB C2518 LB R2518	2.5±0.2 (0.098±0.008)	1.8±0.2 (0.071±0.008)	1.8±0.2 (0.071±0.008)	0.5±0.2 (0.020±0.008)	—	2000
LB 3218	3.2±0.2 (0.126±0.008)	1.8±0.2 (0.071±0.008)	1.8±0.2 (0.071±0.008)	0.6±0.2 (0.024±0.008)	—	2000
LB C3225	3.2±0.2 (0.126±0.008)	2.5±0.2 (0.098±0.008)	2.5±0.2 (0.098±0.008)	0.6±0.3 (0.024±0.012)	—	1000

Unit : mm (inch)

► This catalog contains the typical specification only due to the limitation of space. When you consider the purchase of our products, please check our product specification sheets. For details of each product (characteristics graph, reliability information, precautions for use, and so on), see our website (<http://www.ty-top.com/>).

■ PARTS NUMBER

● 1608 (0603) type

Parts number	EHS	Nominal inductance [μH]	Inductance tolerance	Self-resonant frequency [MHz] (min.)	DC Resistance [Ω] (±30%)	Rated current [mA] (max.)	Measuring frequency [MHz]
LB 1608T1R0M	RoHS	1.0	±20%	100	0.17	160	7.96
LB 1608T2R2M	RoHS	2.2	±20%	80	0.33	115	7.96
LB 1608T4R7M	RoHS	4.7	±20%	45	0.55	70	7.96
LB 1608T8R2M	RoHS	8.2	±20%	32	0.70	60	2.52
LB 1608T100M	RoHS	10	±20%	32	0.70	60	2.52

Parts number	EHS	Nominal inductance [μH]	Inductance tolerance	Self-resonant frequency [MHz] (min.)	DC Resistance [Ω] (±30%)	Rated current [mA] (max.)	Measuring frequency [MHz]
LBMF1608T1R0M	RoHS	1.0	±20%	100	0.09	230	7.96
LBMF1608T2R2M	RoHS	2.2	±20%	80	0.17	160	7.96
LBMF1608T3R3M	RoHS	3.3	±20%	60	0.22	130	7.96
LBMF1608T4R7M	RoHS	4.7	±20%	45	0.24	110	7.96
LBMF1608T100□	RoHS	10	±10%, ±20%	32	0.36	80	2.52
LBMF1608T220□	RoHS	22	±10%, ±20%	16	1.0	50	2.52
LBMF1608T470□	RoHS	47	±10%, ±20%	11	2.5	35	2.52

● 2012 (0805) type

Parts number	EHS	Nominal inductance [μH]	Inductance tolerance	Self-resonant frequency [MHz] (min.)	DC Resistance [Ω] (±30%)	Rated current [mA] (max.)	Measuring frequency [MHz]
LB 2012T1R0M	RoHS	1.0	±20%	100	0.15	405	7.96
LB 2012T2R2M	RoHS	2.2	±20%	80	0.23	260	7.96
LB 2012T3R3M	RoHS	3.3	±20%	55	0.30	235	7.96
LB 2012T4R7M	RoHS	4.7	±20%	45	0.40	190	7.96
LB 2012T6R8M	RoHS	6.8	±20%	38	0.47	135	7.96
LB 2012T100□	RoHS	10	±10%, ±20%	32	0.70	120	2.52
LB 2012T100□R	RoHS	10	±10%, ±20%	32	0.50	120	2.52
LB 2012T150□	RoHS	15	±10%, ±20%	28	1.3	100	2.52
LB 2012T220□	RoHS	22	±10%, ±20%	16	1.7	80	2.52
LB 2012T470□	RoHS	47	±10%, ±20%	11	3.7	60	2.52
LB 2012T680□	RoHS	68	±10%, ±20%	10	6.0	50	2.52
LB 2012T101□	RoHS	100	±10%, ±20%	8	7.0	45	0.796

Parts number	EHS	Nominal inductance [μH]	Inductance tolerance	Self-resonant frequency [MHz] (min.)	DC Resistance [Ω] (±30%)	Rated current [mA] (max.)	Measuring frequency [MHz]
LB C2012T1R0M	RoHS	1.0	±20%	100	0.19	620	7.96
LB C2012T2R2M	RoHS	2.2	±20%	70	0.33	430	7.96
LB C2012T4R7M	RoHS	4.7	±20%	45	0.50	295	7.96
LB C2012T100□	RoHS	10	±10%, ±20%	40	1.2	200	2.52
LB C2012T220□	RoHS	22	±10%, ±20%	16	3.7	130	2.52
LB C2012T470□	RoHS	47	±10%, ±20%	11	5.8	90	2.52

Parts number	EHS	Nominal inductance [μH]	Inductance tolerance	Self-resonant frequency [MHz] (min.)	DC Resistance [Ω] (±30%)	Rated current [mA] (max.)	Measuring frequency [MHz]
LB R2012T1R0M	RoHS	1.0	±20%	100	0.07	400	7.96
LB R2012T2R2M	RoHS	2.2	±20%	80	0.13	260	7.96
LB R2012T4R7M	RoHS	4.7	±20%	45	0.24	200	7.96
LB R2012T100□	RoHS	10	±10%, ±20%	32	0.36	150	2.52
LB R2012T220□	RoHS	22	±10%, ±20%	16	1.0	100	2.52
LB R2012T470□	RoHS	47	±10%, ±20%	11	1.7	75	2.52
LB R2012T101□	RoHS	100	±10%, ±20%	8	4.0	50	0.796

● 2016 (0806) type

Parts number	EHS	Nominal inductance [μH]	Inductance tolerance	Self-resonant frequency [MHz] (min.)	DC Resistance [Ω] (±30%)	Rated current [mA] (max.)	Measuring frequency [MHz]
LB 2016T1R0M	RoHS	1.0	±20%	100	0.09	490	7.96
LB 2016T1R5M	RoHS	1.5	±20%	80	0.11	380	7.96
LB 2016T2R2M	RoHS	2.2	±20%	70	0.13	375	7.96
LB 2016T3R3M	RoHS	3.3	±20%	55	0.20	285	7.96
LB 2016T4R7M	RoHS	4.7	±20%	45	0.25	225	7.96
LB 2016T6R8M	RoHS	6.8	±20%	38	0.35	200	7.96
LB 2016T100□	RoHS	10	±10%, ±20%	32	0.50	155	2.52
LB 2016T150□	RoHS	15	±10%, ±20%	28	0.70	130	2.52
LB 2016T220□	RoHS	22	±10%, ±20%	16	1.0	105	2.52
LB 2016T330□	RoHS	33	±10%, ±20%	14	1.7	85	2.52
LB 2016T470□	RoHS	47	±10%, ±20%	11	2.4	70	2.52
LB 2016T680□	RoHS	68	±10%, ±20%	10	3.0	55	2.52
LB 2016T101□	RoHS	100	±10%, ±20%	8	4.5	40	0.796

□ Please specify the Inductance tolerance code (K or M)

LB/LBC series

Rated Current : The maximum DC value having inductance decrease within 10 % and temperature increase within 20 degC by the application of DC bias.

LBR series

Rated Current : The maximum DC value having inductance decrease within 20 % and temperature increase within 20 degC by the application of DC bias.

▶ This catalog contains the typical specification only due to the limitation of space. When you consider the purchase of our products, please check our product specification sheets. For details of each product (characteristics graph, reliability information, precautions for use, and so on), see our website (<http://www.ty-top.com/>).

■ PARTS NUMBER

Parts number	EHS	Nominal inductance [μH]	Inductance tolerance	Self-resonant frequency [MHz] (min.)	DC Resistance [Ω] (±30%)	Rated current [mA] (max.)	Measuring frequency [MHz]
LB C2016T1R0M	RoHS	1.0	±20%	100	0.10	690	7.96
LB C2016T1R5M	RoHS	1.5	±20%	80	0.15	600	7.96
LB C2016T2R2M	RoHS	2.2	±20%	70	0.20	520	7.96
LB C2016T3R3M	RoHS	3.3	±20%	55	0.27	410	7.96
LB C2016T4R7M	RoHS	4.7	±20%	45	0.37	355	7.96
LB C2016T6R8M	RoHS	6.8	±20%	38	0.59	290	7.96
LB C2016T100□	RoHS	10	±10%, ±20%	32	0.82	245	2.52
LB C2016T150□	RoHS	15	±10%, ±20%	28	1.2	200	2.52
LB C2016T220□	RoHS	22	±10%, ±20%	16	1.8	165	2.52
LB C2016T330□	RoHS	33	±10%, ±20%	14	2.8	135	2.52
LB C2016T470□	RoHS	47	±10%, ±20%	11	4.3	110	2.52
LB C2016T680□	RoHS	68	±10%, ±20%	10	7.0	95	2.52
LB C2016T101□	RoHS	100	±10%, ±20%	8	8.0	75	0.796

● 2518 (1007) type

Parts number	EHS	Nominal inductance [μH]	Inductance tolerance	Self-resonant frequency [MHz] (min.)	DC Resistance [Ω] (±30%)	Rated current [mA] (max.)	Measuring frequency [MHz]
LB 2518T1R0M	RoHS	1.0	±20%	100	0.06	665	7.96
LB 2518T1R5M	RoHS	1.5	±20%	80	0.07	405	7.96
LB 2518T2R2M	RoHS	2.2	±20%	68	0.09	340	7.96
LB 2518T3R3M	RoHS	3.3	±20%	54	0.11	280	7.96
LB 2518T4R7M	RoHS	4.7	±20%	46	0.13	240	7.96
LB 2518T4R7MR	RoHS	4.7	±20%	46	0.10	235	7.96
LB 2518T6R8M	RoHS	6.8	±20%	38	0.15	195	7.96
LB 2518T100□	RoHS	10	±10%, ±20%	30	0.25	165	2.52
LB 2518T150□	RoHS	15	±10%, ±20%	23	0.32	145	2.52
LB 2518T220□	RoHS	22	±10%, ±20%	19	0.50	115	2.52
LB 2518T330□	RoHS	33	±10%, ±20%	15	0.70	95	2.52
LB 2518T470□	RoHS	47	±10%, ±20%	12	0.95	85	2.52
LB 2518T680□	RoHS	68	±10%, ±20%	9.5	1.5	70	2.52
LB 2518T101□	RoHS	100	±10%, ±20%	9.0	2.1	60	0.796
LB 2518T151□	RoHS	150	±10%, ±20%	7.0	3.2	45	0.796
LB 2518T221□	RoHS	220	±10%, ±20%	5.5	4.5	40	0.796
LB 2518T331□	RoHS	330	±10%, ±20%	4.5	7.0	30	0.796
LB 2518T471□	RoHS	470	±10%, ±20%	3.5	10	25	0.796
LB 2518T681□	RoHS	680	±10%, ±20%	3.0	17	20	0.796
LB 2518T102□	RoHS	1000	±10%, ±20%	2.4	24	15	0.252

Parts number	EHS	Nominal inductance [μH]	Inductance tolerance	Self-resonant frequency [MHz] (min.)	DC Resistance [Ω] (±30%)	Rated current [mA] (max.)	Measuring frequency [MHz]
LB C2518T1R0M	RoHS	1.0	±20%	100	0.08	775	7.96
LB C2518T1R0MR	RoHS	1.0	±20%	100	0.07	890	7.96
LB C2518T1R5M	RoHS	1.5	±20%	80	0.11	730	7.96
LB C2518T2R2M	RoHS	2.2	±20%	68	0.13	630	7.96
LB C2518T3R3M	RoHS	3.3	±20%	54	0.16	560	7.96
LB C2518T4R7M	RoHS	4.7	±20%	41	0.20	510	7.96
LB C2518T6R8M	RoHS	6.8	±20%	38	0.30	420	7.96
LB C2518T100□	RoHS	10	±10%, ±20%	30	0.36	375	2.52
LB C2518T150□	RoHS	15	±10%, ±20%	23	0.65	285	2.52
LB C2518T220□	RoHS	22	±10%, ±20%	19	0.77	250	2.52
LB C2518T330□	RoHS	33	±10%, ±20%	15	1.5	185	2.52
LB C2518T470□	RoHS	47	±10%, ±20%	12	1.9	165	2.52
LB C2518T680□	RoHS	68	±10%, ±20%	9.5	2.8	140	2.52
LB C2518T101□	RoHS	100	±10%, ±20%	9.0	3.7	125	0.796
LB C2518T151□	RoHS	150	±10%, ±20%	7.0	6.1	95	0.796
LB C2518T221□	RoHS	220	±10%, ±20%	5.5	8.4	80	0.796
LB C2518T331□	RoHS	330	±10%, ±20%	4.5	12.3	65	0.796
LB C2518T471□	RoHS	470	±10%, ±20%	3.5	22	50	0.796
LB C2518T681□	RoHS	680	±10%, ±20%	3.0	28	45	0.796

Parts number	EHS	Nominal inductance [μH]	Inductance tolerance	Self-resonant frequency [MHz] (min.)	DC Resistance [Ω] (±30%)	Rated current [mA] (max.)	Measuring frequency [MHz]
LB R2518T1R0M	RoHS	1.0	±20%	100	0.045	960	7.96
LB R2518T2R2M	RoHS	2.2	±20%	68	0.07	480	7.96
LB R2518T4R7M	RoHS	4.7	±20%	45	0.10	345	7.96
LB R2518T100□	RoHS	10	±10%, ±20%	30	0.19	235	2.52
LB R2518T220□	RoHS	22	±10%, ±20%	19	0.44	175	2.52
LB R2518T470□	RoHS	47	±10%, ±20%	11	0.84	120	2.52
LB R2518T101□	RoHS	100	±10%, ±20%	9	1.89	80	0.796

□ Please specify the Inductance tolerance code (K or M)

LB/LBC series

Rated Current : The maximum DC value having inductance decrease within 10 % and temperature increase within 20 degC by the application of DC bias.

LBR series

Rated Current : The maximum DC value having inductance decrease within 20 % and temperature increase within 20 degC by the application of DC bias.

▶ This catalog contains the typical specification only due to the limitation of space. When you consider the purchase of our products, please check our product specification sheets. For details of each product (characteristics graph, reliability information, precautions for use, and so on), see our website (<http://www.ty-top.com/>).

■ PARTS NUMBER

● 3218(1207) type

Parts number	EHS	Nominal inductance [μ H]	Inductance tolerance	Self-resonant frequency [MHz] (min.)	DC Resistance [Ω] ($\pm 30\%$)	Rated current [mA] (max.)	Measuring frequency [MHz]
LB 3218T1R0M	RoHS	1.0	$\pm 20\%$	100	0.06	1,075	7.96
LB 3218T1R5M	RoHS	1.5	$\pm 20\%$	80	0.07	860	7.96
LB 3218T2R2M	RoHS	2.2	$\pm 20\%$	68	0.09	775	7.96
LB 3218T3R3M	RoHS	3.3	$\pm 20\%$	54	0.11	560	7.96
LB 3218T4R7M	RoHS	4.7	$\pm 20\%$	41	0.13	550	7.96
LB 3218T6R8M	RoHS	6.8	$\pm 20\%$	40	0.17	380	7.96
LB 3218T100□	RoHS	10	$\pm 10\%, \pm 20\%$	30	0.25	340	2.52
LB 3218T150□	RoHS	15	$\pm 10\%, \pm 20\%$	25	0.32	300	2.52
LB 3218T220□	RoHS	22	$\pm 10\%, \pm 20\%$	19	0.49	255	2.52
LB 3218T330□	RoHS	33	$\pm 10\%, \pm 20\%$	15	0.75	215	2.52
LB 3218T470□	RoHS	47	$\pm 10\%, \pm 20\%$	12	0.92	205	2.52
LB 3218T680□	RoHS	68	$\pm 10\%, \pm 20\%$	11	1.49	145	2.52
LB 3218T101□	RoHS	100	$\pm 10\%, \pm 20\%$	8.0	2.4	140	0.796
LB 3218T151□	RoHS	150	$\pm 10\%, \pm 20\%$	7.0	3.2	105	0.796
LB 3218T221□	RoHS	220	$\pm 10\%, \pm 20\%$	5.0	5.4	80	0.796
LB 3218T331□	RoHS	330	$\pm 10\%, \pm 20\%$	4.0	7.0	65	0.796
LB 3218T471□	RoHS	470	$\pm 10\%, \pm 20\%$	3.5	14	54	0.796
LB 3218T681□	RoHS	680	$\pm 10\%, \pm 20\%$	3.0	17	45	0.796
LB 3218T102□	RoHS	1000	$\pm 10\%, \pm 20\%$	2.4	27	39	0.252

● 3225(1210) type

Parts number	EHS	Nominal inductance [μ H]	Inductance tolerance	Self-resonant frequency [MHz] (min.)	DC Resistance [Ω] ($\pm 30\%$)	Rated current [mA] (max.)	Measuring frequency [MHz]
LB C3225T1R0MR	RoHS	1.0	$\pm 20\%$	250	0.055	1,100	0.1
LB C3225T1R5MR	RoHS	1.5	$\pm 20\%$	220	0.060	1,000	0.1
LB C3225T2R2MR	RoHS	2.2	$\pm 20\%$	190	0.080	930	0.1
LB C3225T3R3MR	RoHS	3.3	$\pm 20\%$	160	0.095	820	0.1
LB C3225T4R7MR	RoHS	4.7	$\pm 20\%$	70	0.100	680	0.1
LB C3225T6R8MR	RoHS	6.8	$\pm 20\%$	50	0.120	620	0.1
LB C3225T100□R	RoHS	10	$\pm 10\%, \pm 20\%$	23	0.133	540	0.1
LB C3225T150□R	RoHS	15	$\pm 10\%, \pm 20\%$	20	0.195	420	0.1
LB C3225T220□R	RoHS	22	$\pm 10\%, \pm 20\%$	17	0.27	330	0.1
LB C3225T330□R	RoHS	33	$\pm 10\%, \pm 20\%$	13	0.41	300	0.1
LB C3225T470□R	RoHS	47	$\pm 10\%, \pm 20\%$	10	0.67	220	0.1
LB C3225T680□R	RoHS	68	$\pm 10\%, \pm 20\%$	8	1.0	190	0.1
LB C3225T101□R	RoHS	100	$\pm 10\%, \pm 20\%$	6	1.4	150	0.1

* □ Please specify the Inductance tolerance code (K or M)

LB/LBC series

Rated Current : The maximum DC value having inductance decrease within 10 % and temperature increase within 20 degC by the application of DC bias.

▶ This catalog contains the typical specification only due to the limitation of space. When you consider the purchase of our products, please check our product specification sheets. For details of each product (characteristics graph, reliability information, precautions for use, and so on), see our website (<http://www.ty-top.com/>).

WIRE-WOUND CHIP INDUCTORS FOR SIGNAL LINES (LB SERIES M TYPE)



REFLOW

■ PARTS NUMBER

* Operating Temp.: -40~+105°C (Including self-generated heat)

L	B	M	△	2	0	1	6	T	1	0	0	J	△
①				②				③	④			⑤	⑥

△=Blank space

① Series name

Code	Series name
LBM△	Wound chip inductor for signal line

② Dimensions (L × W)

Code	Dimensions (L × W) [mm]
2016	2.0 × 1.6

③ Packaging

Code	Packaging
T	Taping

④ Nominal inductance

Code (example)	Nominal inductance [μH]
R12	0.12
1R0	1.0
100	10
101	100

※R=Decimal point

⑤ Inductance tolerance

Code	Inductance tolerance
J	±5%

⑥ Internal code

■ STANDARD EXTERNAL DIMENSIONS / STANDARD QUANTITY

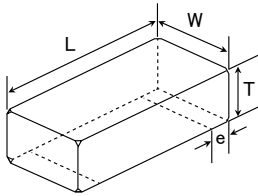

Recommended Land Patterns

Surface Mounting

- Mounting and soldering conditions should be checked beforehand.
- Applicable soldering process to these products is reflow soldering only.

Type	A	B	C
LBM 2016	0.6	1.0	1.8

Unit: mm

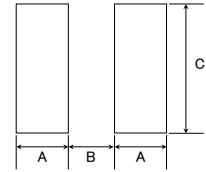

Type	L	W	T	e	Standard quantity [pcs]	
					Paper tape	Embossed tape
LBM 2016	2.0±0.2 (0.08±0.008)	1.6±0.2 (0.063±0.008)	1.6±0.2 (0.063±0.008)	0.5±0.2 (0.02±0.008)	—	2000

Unit: mm (inch)

● LBM2016 type

Parts number	EHS	Nominal inductance [μ H]	Inductance tolerance	Q (min.)	Self-resonant frequency [MHz] (min.)	DC Resistance [Ω] ($\pm 30\%$)	Rated current [mA] (max.)	Measuring frequency [MHz]
LBM 2016TR12J	RoHS	0.12	$\pm 5\%$	30	600	0.13	610	25.2
LBM 2016TR15J	RoHS	0.15	$\pm 5\%$	30	550	0.15	570	25.2
LBM 2016TR18J	RoHS	0.18	$\pm 5\%$	30	500	0.15	560	25.2
LBM 2016TR22J	RoHS	0.22	$\pm 5\%$	30	450	0.20	520	25.2
LBM 2016TR27J	RoHS	0.27	$\pm 5\%$	30	425	0.21	510	25.2
LBM 2016TR33J	RoHS	0.33	$\pm 5\%$	30	400	0.21	490	25.2
LBM 2016TR39J	RoHS	0.39	$\pm 5\%$	30	375	0.26	440	25.2
LBM 2016TR47J	RoHS	0.47	$\pm 5\%$	30	350	0.26	430	25.2
LBM 2016TR56J	RoHS	0.56	$\pm 5\%$	30	300	0.29	410	25.2
LBM 2016TR68J	RoHS	0.68	$\pm 5\%$	30	270	0.32	400	25.2
LBM 2016TR82J	RoHS	0.82	$\pm 5\%$	30	250	0.34	390	25.2
LBM 2016T1R0J	RoHS	1.0	$\pm 5\%$	30	220	0.38	385	7.96
LBM 2016T1R2J	RoHS	1.2	$\pm 5\%$	30	180	0.41	370	7.96
LBM 2016T1R5J	RoHS	1.5	$\pm 5\%$	30	135	0.47	350	7.96
LBM 2016T1R8J	RoHS	1.8	$\pm 5\%$	30	100	0.48	345	7.96
LBM 2016T2R2J	RoHS	2.2	$\pm 5\%$	30	75	0.54	340	7.96
LBM 2016T2R7J	RoHS	2.7	$\pm 5\%$	30	55	0.59	310	7.96
LBM 2016T3R3J	RoHS	3.3	$\pm 5\%$	30	48	0.68	290	7.96
LBM 2016T3R9J	RoHS	3.9	$\pm 5\%$	30	43	0.74	275	7.96
LBM 2016T4R7J	RoHS	4.7	$\pm 5\%$	30	40	0.78	270	7.96
LBM 2016T5R6J	RoHS	5.6	$\pm 5\%$	25	36	0.88	255	7.96
LBM 2016T6R8J	RoHS	6.8	$\pm 5\%$	25	33	0.97	240	7.96
LBM 2016T8R2J	RoHS	8.2	$\pm 5\%$	25	30	1.1	225	7.96
LBM 2016T100J	RoHS	10	$\pm 5\%$	25	27	1.2	215	2.52
LBM 2016T120J	RoHS	12	$\pm 5\%$	25	23	1.4	200	2.52
LBM 2016T150J	RoHS	15	$\pm 5\%$	25	20	1.5	190	2.52
LBM 2016T180J	RoHS	18	$\pm 5\%$	25	18	2.5	150	2.52
LBM 2016T220J	RoHS	22	$\pm 5\%$	25	17	2.8	140	2.52
LBM 2016T270J	RoHS	27	$\pm 5\%$	25	16	3.2	130	2.52
LBM 2016T330J	RoHS	33	$\pm 5\%$	25	15	3.6	125	2.52
LBM 2016T390J	RoHS	39	$\pm 5\%$	20	14	3.9	120	2.52
LBM 2016T470J	RoHS	47	$\pm 5\%$	20	13	4.1	115	2.52
LBM 2016T560J	RoHS	56	$\pm 5\%$	20	12	5.9	95	2.52
LBM 2016T680J	RoHS	68	$\pm 5\%$	20	11	7.0	90	2.52
LBM 2016T820J	RoHS	82	$\pm 5\%$	20	10	7.7	85	2.52
LBM 2016T101J	RoHS	100	$\pm 5\%$	15	9.0	8.0	80	0.796
LBM 2016T151J	RoHS	150	$\pm 5\%$	15	6.5	13.5	69	0.796
LBM 2016T181J	RoHS	180	$\pm 5\%$	15	6.0	15	67	0.796
LBM 2016T221J	RoHS	220	$\pm 5\%$	15	5.5	18	65	0.796

※) Rated Current : The maximum DC value having inductance decrease within 10 % and temperature increase within 20 degC by the application of DC bias.

WIRE-WOUND CHIP INDUCTORS (LB SERIES), WIRE-WOUND CHIP POWER INDUCTORS (CB SERIES), WIRE-WOUND CHIP INDUCTORS FOR SIGNAL LINES (LB SERIES M TYPE)

PACKAGING

① Minimum Quantity

Type	Standard Quantity [pcs]	
	Paper Tape	Embossed Tape
LB C3225	—	1000
CB C3225	—	1000
LB 3218	—	2000
LB R2518	—	2000
LB C2518	—	2000
LB 2518	—	2000
CB 2518	—	2000
CB C2518	—	2000
LBM2016	—	2000
LB C2016	—	2000
LB 2016	—	2000
CB 2016	—	2000
CB C2016	—	2000
LB 2012	—	3000
LB C2012	—	3000
LB R2012	—	3000
CB 2012	—	3000
CB C2012	—	3000
CB L2012	4000	—
LB 1608	4000	—
LBMF1608	—	3000
CBMF1608	—	3000

② Tape material

● Embossed tape

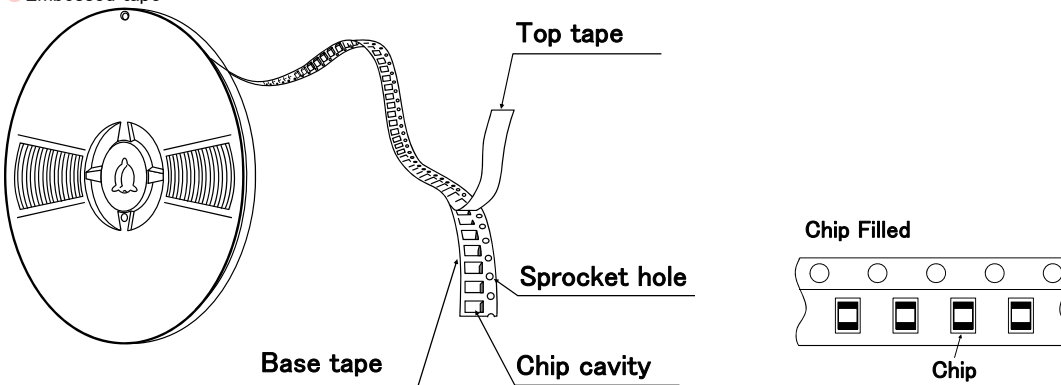

● Card board carrier tape

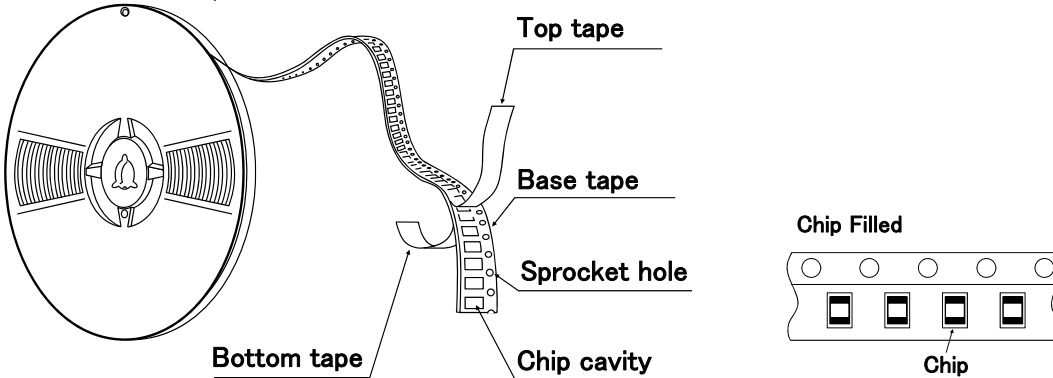

▶ This catalog contains the typical specification only due to the limitation of space. When you consider the purchase of our products, please check our specification. For details of each product (characteristics graph, reliability information, precautions for use, and so on), see our Web site (<http://www.ty-top.com/>).

③ Taping Dimensions

● Embossed Tape (0.315 inches wide)

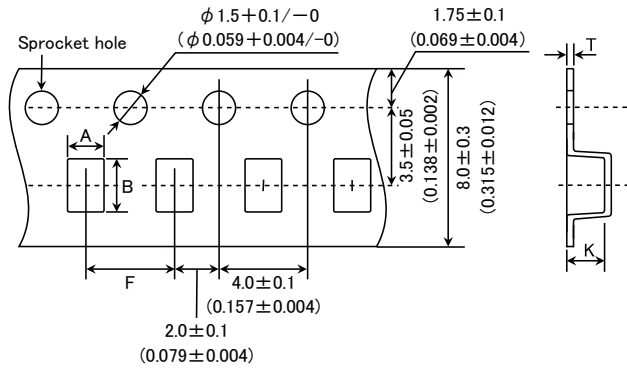

Type	Chip cavity		Insertion pitch	Tape thickness	
	A	B	F	T	K
LBM2016	1.75 ± 0.1 (0.069 ± 0.004)	2.1 ± 0.1 (0.083 ± 0.004)	4.0 ± 0.1 (0.157 ± 0.004)	0.3 ± 0.05 (0.012 ± 0.002)	1.9max. (0.075max.)
LB C3225 CB C3225	2.8 ± 0.1 (0.110 ± 0.004)	3.5 ± 0.1 (0.138 ± 0.004)	4.0 ± 0.1 (0.157 ± 0.004)	0.3 ± 0.05 (0.012 ± 0.002)	4.0max. (0.157max.)
LB 3218	2.1 ± 0.1 (0.083 ± 0.004)	3.5 ± 0.1 (0.138 ± 0.004)	4.0 ± 0.1 (0.157 ± 0.004)	0.3 ± 0.05 (0.012 ± 0.002)	2.2max. (0.087max.)
LB 2518 CB 2518 LB C2518 CB C2518 LB R2518	2.15 ± 0.1 (0.085 ± 0.004)	2.7 ± 0.1 (0.106 ± 0.004)	4.0 ± 0.1 (0.157 ± 0.004)	0.3 ± 0.05 (0.012 ± 0.002)	2.2max. (0.087max.)
LB 2016 CB 2016 LB C2016 CB C2016	1.75 ± 0.1 (0.069 ± 0.004)	2.1 ± 0.1 (0.083 ± 0.004)	4.0 ± 0.1 (0.157 ± 0.004)	0.3 ± 0.05 (0.012 ± 0.002)	1.9max. (0.075max.)
LB 2012 CB 2012 LB C2012 CB C2012 LB R2012	1.45 ± 0.1 (0.057 ± 0.004)	2.25 ± 0.1 (0.089 ± 0.004)	4.0 ± 0.1 (0.157 ± 0.004)	0.25 ± 0.05 (0.010 ± 0.002)	1.45max. (0.057max.)
LBMF1608 CBMF1608	1.1 ± 0.1 (0.043 ± 0.004)	1.9 ± 0.1 (0.075 ± 0.004)	4.0 ± 0.1 (0.157 ± 0.004)	0.25 ± 0.05 (0.010 ± 0.002)	1.2max. (0.047max.)

Unit: mm (inch)

● Card board carrier tape (0.315 inches wide)

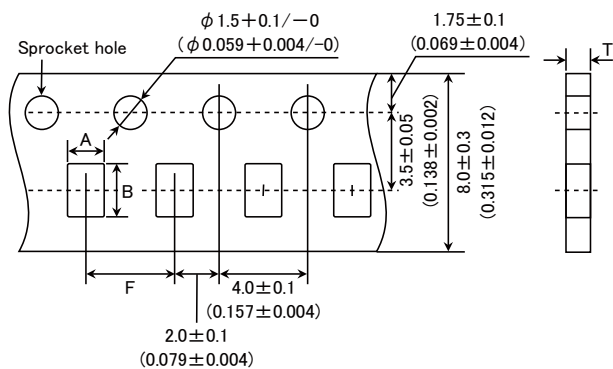

Type	Chip cavity		Insertion pitch	Tape thickness
	A	B	F	T
CB L2012	1.55 ± 0.1 (0.061 ± 0.004)	2.3 ± 0.1 (0.091 ± 0.004)	4.0 ± 0.1 (0.157 ± 0.004)	1.1max. (0.043max.)
LB 1608	1.0 ± 0.1 (0.039 ± 0.004)	1.8 ± 0.1 (0.071 ± 0.004)	4.0 ± 0.1 (0.157 ± 0.004)	1.1max. (0.043max.)

Unit: mm (inch)

④ Leader and Blank Portion

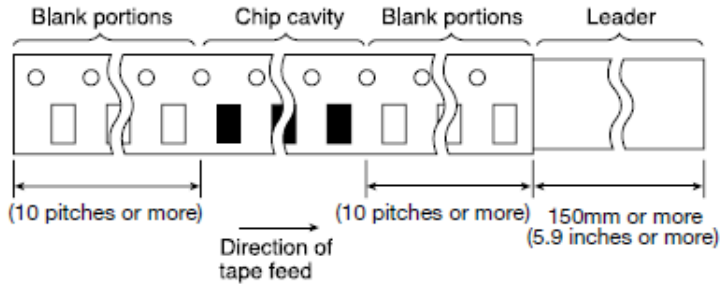

⑤ Reel Size

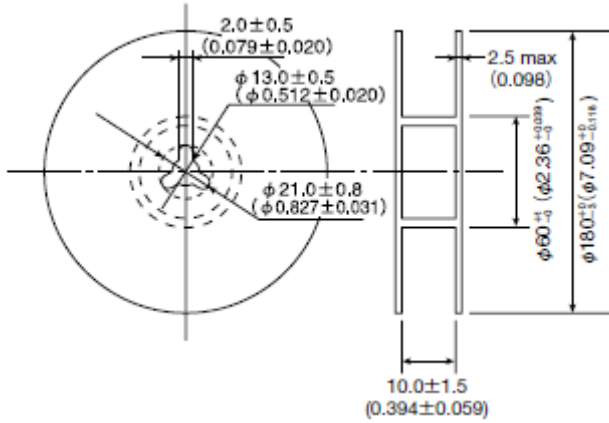

⑥ Top Tape Strength

The top tape requires a peel-off force 0.2 to 0.7N in the direction of the arrow as illustrated below.

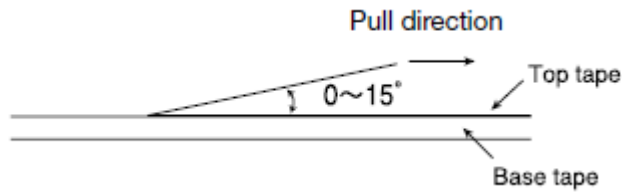

WIRE-WOUND CHIP INDUCTORS (LB SERIES), WIRE-WOUND CHIP POWER INDUCTORS (CB SERIES), WIRE-WOUND CHIP INDUCTORS FOR SIGNAL LINES (LB SERIES M TYPE)

RELIABILITY DATA

1. Operating temperature Range		
Specified Value	LB, LBC, LBR, LBMF Series	-40~ +105°C (Including self-generated heat)
	CB, CBC, CBL, CBMF Series	
	LBM Series	
2. Storage Temperature Range (after soldering)		
Specified Value	LB, LBC, LBR, LBMF Series	-40~ +85°C
	CB, CBC, CBL, CBMF Series	
	LBM Series	
Test Methods and Remarks	LB, CB Series : Please refer the term of "7. storage conditions" in precautions.	
3. Rated Current		
Specified Value	LB, LBC, LBR, LBMF Series	Within the specified tolerance
	CB, CBC, CBL, CBMF Series	
	LBM Series	
4. Inductance		
Specified Value	LB, LBC, LBR, LBMF Series	Within the specified tolerance
	CB, CBC, CBL, CBMF Series	
	LBM Series	
Test Methods and Remarks	LB・LBC・LBR・CB・CBC・CBL・LBMF・CBMF・LBM Series Measuring equipment : LCR Meter (HP4285A or its equivalent) Measuring frequency : Specified frequency	
5. Q		
Specified Value	LB, LBC, LBR, LBMF Series	-
	CB, CBC, CBL, CBMF Series	
	LBM Series	
Test Methods and Remarks	LBM Series Measuring equipment : LCR Meter (HP4285A or its equivalent) Measuring frequency : Specified frequency	
6. DC Resitance		
Specified Value	LB, LBC, LBR, LBMF Series	Within the specified tolerance
	CB, CBC, CBL, CBMF Series	
	LBM Series	
Test Methods and Remarks	Measuring equipment : DC Ohmmeter (HIOKI 3227 or its equivalent)	
7. Self-Resonant Frequency		
Specified Value	LB, LBC, LBR, LBMF Series	Within the specified tolerance
	CB, CBC, CBL, CBMF Series	
	LBM Series	
Test Methods and Remarks	Measuring equipment : Impedance analyzer (HP4291A or its equivalent)	

▶ This catalog contains the typical specification only due to the limitation of space. When you consider the purchase of our products, please check our specification.
For details of each product (characteristics graph, reliability information, precautions for use, and so on), see our Web site (<http://www.ty-top.com/>).

8. Temperature Characteristic					
Specified Value	LBM2016				Inductance change : Within $\pm 5\%$
	LB1608	LB2012	LBR2012	CB2012	Inductance change : Within $\pm 20\%$
	CBL2012	LB2016	CB2016	LB2518	
	LBR2518	CB2518	LBC3225	CBC3225	
	LBMF1608	CBMF1608	LBC2016	CBC2016	Inductance change : Within $\pm 25\%$
LBC2518	CBC2518	LB3218			
Test Methods and Remarks	LBC2012	CBC2012			Inductance change : Within $\pm 35\%$
	Based on the inductance at 20°C and Measured at the ambient of $-40^{\circ}\text{C} \sim +85^{\circ}\text{C}$.				

9. Resistance to Flexure of Substrate			
Specified Value	LB, LBC, LBR, LBMF Series		No damage.
	CB, CBC, CBL, CBMF Series		
	LBM Series		
Test Methods and Remarks	Warp : 2mm (LB·LBC·LBR·CB·CBC·CBL·LBM·LBMF·CBMF Series)		
	Test substrate : Glass epoxy-resin substrate Thickness : 0.8mm (LB1608·LBMF1608·CBMF1608) : 1.0mm (Others)		

10. Body Strength			
Specified Value	LB, LBC, LBR, LBMF Series		No damage.
	CB, CBC, CBL, CBMF Series		
	LBM Series		
Test Methods and Remarks	LB·LBC·LBR·CB·CBC·CBL·LBM		
	Applied force : 10N Duration : 10sec. LB1608·LBMF1608·CBMF1608 Applied force : 5N Duration : 10sec.		

11. Adhesion of terminal electrode			
Specified Value	LB, LBC, LBR, LBMF Series		No abnormality.
	CB, CBC, CBL, CBMF Series		
	LBM Series		
Test Methods and Remarks	LB·LBC·LBR·CB·CBC·CBL·LBM·LBMF·CBMF		
	Applied force : 10N to X and Y directions Duration : 5 sec. Test substrate : Printed board LB1608·CBMF1608·LBMF1608 Applied force : 5N to X and Y directions Duration : 5 sec. Test substrate : Printed board		

▶ This catalog contains the typical specification only due to the limitation of space. When you consider the purchase of our products, please check our specification.
 For details of each product (characteristics graph, reliability information, precautions for use, and so on), see our Web site (<http://www.ty-top.com/>).

12. Resistance to vibration		
Specified Value	LB, LBC, LBR, LBMF Series	Inductance change : Within $\pm 10\%$ No significant abnormality in appearance.
	CB, CBC, CBL, CBMF Series	
	LBM Series	Inductance change : Within $\pm 5\%$ No significant abnormality in appearance.
Test Methods and Remarks	LB·LBR·LBC·CB·CBC·CBL·LBM·LBMF·CBMF :	
	The given sample is soldered to the board and then it is tested depending on the conditions of the following table.	
	Vibration Frequency	10~55Hz
	Total Amplitude	1.5mm (May not exceed acceleration 196m/s ²)
	Sweeping Method	10Hz to 55Hz to 10Hz for 1min.
	Time	X Y Z
		For 2 hours on each X, Y, and Z axis.
	Recovery	: At least 2 hrs of recovery under the standard condition after the test, followed by the measurement within 48 hrs.

13. Drop test		
Specified Value	LB, LBC, LBR, LBMF Series	—
	CB, CBC, CBL, CBMF Series	
	LBM Series	

14. Solderability		
Specified Value	LB, LBC, LBR, LBMF Series	At least 90% of surface of terminal electrode is covered by new
	CB, CBC, CBL, CBMF Series	
	LBM Series	
Test Methods and Remarks	LB·LBC·LBR·CB·CBC·CBL·LBM·LBMF·CBMF :	
	Solder temperature	: 245 \pm 5 $^{\circ}$ C
	Duration	: 5 \pm 0.5sec
	Flux	: Methanol solution with 25% of colophony

15. Resistance to soldering		
Specified Value	LB, LBC, LBR, LBMF Series	Inductance change : Within $\pm 10\%$
	CB, CBC, CBL, CBMF Series	
	LBM Series	Inductance change : Within $\pm 5\%$
Test Methods and Remarks	LB·LBC·LBR·CB·CBC·CBL·LBM·LBMF·CBMF :	
	3 times of reflow oven at 230 $^{\circ}$ C MIN for 40sec. with peak temperature at 260 $^{\circ}$ C for 5sec. Recovery : At least 2 hrs of recovery under the standard condition after the test, followed by the measurement within 48 hrs.	

16. Resistance to solvent		
Specified Value	LB, LBC, LBR, LBMF Series	—
	CB, CBC, CBL, CBMF Series	
	LBM Series	
Test Methods and Remarks	Solvent temperature	: Room temperature
	Type of solvent	: Isopropyl alcohol
	Cleaning conditions	: 90s. Immersion and cleaning.

17. Thermal shock			
Specified Value	LB, LBC, LBR, LBMF Series	Inductance change : Within $\pm 10\%$ No significant abnormality in appearance.	
	CB, CBC, CBL, CBMF Series		
	LBM Series		
Test Methods and Remarks	LB·LBC·LBR·CB·CBC·CBL·LBM·LBMF·CBMF :		
	The given sample is soldered to the board and then its Inductance is measured after 100cycles of the following conditions.		
	Conditions of 1 cycle		
	Step	Temperature ($^{\circ}$ C)	Duration (min)
	1	-40 \pm 3	30 \pm 3
	2	Room temperature	Within 3
3	+85 \pm 2	30 \pm 3	
4	Room temperature	Within 3	
	Recovery	: At least 2 hrs of recovery under the standard condition after the test, followed by the measurement within 48 hrs.	

▶ This catalog contains the typical specification only due to the limitation of space. When you consider the purchase of our products, please check our specification.
For details of each product (characteristics graph, reliability information, precautions for use, and so on), see our Web site (<http://www.ty-top.com/>).

18.Damp heat life test		
Specified Value	LB, LBC, LBR, LBMF Series	Inductance change : Within $\pm 10\%$ No significant abnormality in appearance.
	CB, CBC, CBL, CBMF Series	
	LBM Series	
Test Methods and Remarks	Temperature : $60 \pm 2^\circ\text{C}$ Humidity : $90 \sim 95\% \text{RH}$ Duration : 1000 hrs Recovery : At least 2 hrs of recovery under the standard condition after the test, followed by the measurement within 48 hrs.	

19.Loading under damp heat life test		
Specified Value	LB, LBC, LBR, LBMF Series	Inductance change : Within $\pm 10\%$ No significant abnormality in appearance.
	CB, CBC, CBL, CBMF Series	
	LBM Series	
Test Methods and Remarks	Temperature : $60 \pm 2^\circ\text{C}$ Humidity : $90 \sim 95\% \text{RH}$ Duration : 1000 hrs Applied current : Rated current Recovery : At least 2 hrs of recovery under the standard condition after the test, followed by the measurement within 48 hrs.	

20.High temperature life test		
Specified Value	LB, LBC, LBR, LBMF Series	—
	CB, CBC, CBL, CBMF Series	Inductance change : Within $\pm 10\%$ No significant abnormality in appearance.
	LBM Series	
Test Methods and Remarks	Temperature : $85 \pm 2^\circ\text{C}$ Duration : 1000 hrs Recovery : At least 2 hrs of recovery under the standard condition after the test, followed by the measurement within 48 hrs.	

21.Loading at high temperature life test		
Specified Value	LB, LBC, LBR, LBMF Series	Inductance change : Within $\pm 10\%$ (LBC3225 Series : Within $\pm 20\%$) No significant abnormality in appearance.
	CB, CBC, CBL, CBMF Series	
	LBM Series	—
Test Methods and Remarks	Temperature : $85 \pm 2^\circ\text{C}$ Duration : 1000 hrs Applied current : Rated current Recovery : At least 2 hrs of recovery under the standard condition after the test, followed by the measurement within 48 hrs.	

22.Low temperature life test		
Specified Value	LB, LBC, LBR, LBMF Series	Inductance change : Within $\pm 10\%$ No significant abnormality in appearance.
	CB, CBC, CBL, CBMF Series	
	LBM Series	
Test Methods and Remarks	Temperature : $-40 \pm 2^\circ\text{C}$ Duration : 1000 hrs Recovery : At least 2 hrs of recovery under the standard condition after the test, followed by the measurement within 48 hrs.	

23.Standard condition		
Specified Value	LB, LBC, LBR, LBMF Series	Standard test conditions Unless specified, Ambient temperature is $20 \pm 15^\circ\text{C}$ and the Relative humidity is $65 \pm 20\%$. If there is any doubt about the test results, further measurement shall be had within the following limits: Ambient Temperature: $20 \pm 2^\circ\text{C}$ Relative humidity: $65 \pm 5\%$ Inductance value is based on our standard measurement systems.
	CB, CBC, CBL, CBMF Series	
	LBM Series	

▶ This catalog contains the typical specification only due to the limitation of space. When you consider the purchase of our products, please check our specification.
For details of each product (characteristics graph, reliability information, precautions for use, and so on), see our Web site (<http://www.ty-top.com/>).

WIRE-WOUND CHIP INDUCTORS (LB SERIES), WIRE-WOUND CHIP POWER INDUCTORS (CB SERIES), WIRE-WOUND CHIP INDUCTORS FOR SIGNAL LINES (LB SERIES M TYPE)

■ PRECAUTIONS

1. Circuit Design	
Precautions	<p>◆Operating environment</p> <p>1. The products described in this specification are intended for use in general electronic equipment, (office supply equipment, telecommunications systems, measuring equipment, and household equipment). They are not intended for use in mission-critical equipment or systems requiring special quality and high reliability (traffic systems, safety equipment, aerospace systems, nuclear control systems and medical equipment including life-support systems,) where product failure might result in loss of life, injury or damage. For such uses, contact TAIYO YUDEN Sales Department in advance.</p>
2. PCB Design	
Precautions	<p>◆Land pattern design</p> <p>1. Please contact any of our offices for a land pattern, and refer to a recommended land pattern of a right figure or specifications.</p>
Technical considerations	<p>PRECAUTIONS 【Recommended Land Patterns】</p> <p>Surface Mounting</p> <ul style="list-style-type: none"> • Mounting and soldering conditions should be checked beforehand. • Applicable soldering process to those products is reflow soldering only.
3. Considerations for automatic placement	
Precautions	<p>◆Adjustment of mounting machine</p> <p>1. Excessive impact load should not be imposed on the products when mounting onto the PC boards.</p> <p>2. Mounting and soldering conditions should be checked beforehand.</p>
Technical considerations	<p>1. When installing products, care should be taken not to apply distortion stress as it may deform the products.</p>
4. Soldering	
Precautions	<p>◆Reflow soldering(LB and CB Types)</p> <p>1. For reflow soldering with either leaded or lead-free solder, the profile specified in "point for controlling" is recommended.</p> <p>◆Recommended conditions for using a soldering iron</p> <p>1. Put the soldering iron on the land-pattern. Soldering iron's temperature - Below 350°C Duration-3 seconds or less. The soldering iron should not come in contact with inductor directly.</p>
Technical considerations	<p>◆Reflow soldering(LB and CB Types)</p> <p>1. Reflow profile</p> <p>Temperature [°C]</p> <p>Heating Time [sec]</p> <p>150~180</p> <p>90±30sec</p> <p>30±10sec</p> <p>230°C min</p> <p>5sec max</p> <p>Peak: 260+0/-5°C</p> <p>◆Recommended conditions for using a soldering iron</p> <p>1. Components can be damaged by excessive heat where soldering conditions exceed the specified range.</p>
5. Cleaning	
Precautions	<p>◆Cleaning conditions</p> <p>Washing by supersonic waves shall be avoided.</p>
Technical considerations	<p>◆Cleaning conditions</p> <p>If washed by supersonic waves, the products might be broken.</p>

6. Handling	
Precautions	<ul style="list-style-type: none"> ◆ Handling <ol style="list-style-type: none"> 1. Keep the inductors away from all magnets and magnetic objects. ◆ Breakaway PC boards (splitting along perforations) <ol style="list-style-type: none"> 1. When splitting the PC board after mounting inductors, care should be taken not to give any stresses of deflection or twisting to the board. 2. Board separation should not be done manually, but by using the appropriate devices. ◆ Mechanical considerations <ol style="list-style-type: none"> 1. Please do not give the inductors any excessive mechanical shocks.
Technical considerations	<ul style="list-style-type: none"> ◆ Handling <ol style="list-style-type: none"> 1. There is a case that a characteristic varies with magnetic influence. ◆ Breakaway PC boards (splitting along perforations) <ol style="list-style-type: none"> 1. Planning pattern configurations and the position of products should be carefully performed to minimize stress. ◆ Mechanical considerations <ol style="list-style-type: none"> 1. There is a case to be damaged by a mechanical shock.

7. Storage conditions	
Precautions	<ul style="list-style-type: none"> ◆ Storage <ol style="list-style-type: none"> 1. To maintain the solderability of terminal electrodes and to keep the packing material in good condition, temperature and humidity in the storage area should be controlled. <ul style="list-style-type: none"> • Recommended conditions <ul style="list-style-type: none"> Ambient temperature : 0~40°C Humidity : Below 70% RH • The ambient temperature must be kept below 30°C. Even under ideal storage conditions, solderability of products electrodes may decrease as time passes. <ul style="list-style-type: none"> For this reason, product should be used within 6 months from the time of delivery. In case of storage over 6 months, solderability shall be checked before actual usage.
Technical considerations	<ul style="list-style-type: none"> ◆ Storage <ol style="list-style-type: none"> 1. Under a high temperature and humidity environment, problems such as reduced solderability caused by oxidation of terminal electrodes and deterioration of taping/packaging materials may take place.

MULTILAYER CHIP INDUCTORS(LK SERIES)



WAVE* REFLOW

*Except for LK1005

PARTS NUMBER

* Operating Temp.: -40~+85°C

L	K	△	1	6	0	8	△	R	1	0	M	-	T	△
①			②					③			④		⑤	⑥

△=Blank space

①Series name

Code	Series name
LK△	Multilayer chip inductor

②Dimensions (L × W)

Code	Type (inch)	Dimensions (L × W) [mm]
1005	1005 (0402)	1.0 × 0.5
1608	1608 (0603)	1.6 × 0.8
2125	2125 (0805)	2.0 × 1.25

③Nominal inductance

Code (example)	Nominal inductance [μH]
47N	0.047
R10	0.1
1R0	1.0
100	10

※R=Decimal point

※N=0.0(nH type)

④Inductance tolerance

Code	Inductance tolerance
K	±10%
M	±20%

⑤Packaging

Code	Packaging
-T	Taping

⑥Internal code

Code	Internal code
△	Standard

STANDARD EXTERNAL DIMENSIONS / STANDARD QUANTITY

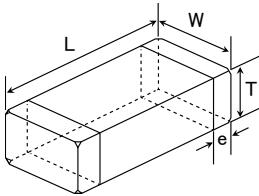

Type	L	W	T	e	Standard quantity [pcs]	
					Paper tape	Embossed tape
LK 1005 (0402)	1.00±0.05 (0.039±0.002)	0.50±0.05 (0.020±0.002)	0.50±0.05 (0.020±0.002)	0.25±0.10 (0.010±0.004)	10000	—
LK 1608 (0603)	1.6±0.15 (0.063±0.006)	0.8±0.15 (0.031±0.006)	0.8±0.15 (0.031±0.006)	0.3±0.2 (0.012±0.008)	4000	—
LK 2125 (0805)	2.0+0.3/-0.1 (0.079+0.012/-0.004)	1.25±0.2 (0.049±0.008)	0.85±0.2 (0.033±0.008)	0.5±0.3 (0.020±0.012)	4000	—
	2.0+0.3/-0.1 (0.079+0.012/-0.004)	1.25±0.2 (0.049±0.008)	1.25±0.2 (0.049±0.008)	0.5±0.3 (0.020±0.012)	—	2000

Unit: mm (inch)

► This catalog contains the typical specification only due to the limitation of space. When you consider the purchase of our products, please check our product specification sheets. For details of each product (characteristics graph, reliability information, precautions for use, and so on), see our website (<http://www.ty-top.com/>).

● LK1005

Parts number	EHS	Nominal inductance [μ H]	Inductance tolerance	Q (min.)	Self-resonant frequency [MHz] (min.)	DC Resistance [Ω] (max.)	Rated current [mA] (max.)	Measuring frequency [MHz]	Thickness [mm]
LK 1005 R12□-T	RoHS	0.12	$\pm 10\%$, $\pm 20\%$	10	180	0.59	25	25	0.50 ± 0.05
LK 1005 R15□-T	RoHS	0.15	$\pm 10\%$, $\pm 20\%$	10	165	0.63	25	25	0.50 ± 0.05
LK 1005 R18□-T	RoHS	0.18	$\pm 10\%$, $\pm 20\%$	10	150	0.76	25	25	0.50 ± 0.05
LK 1005 R22□-T	RoHS	0.22	$\pm 10\%$, $\pm 20\%$	10	135	0.79	25	25	0.50 ± 0.05
LK 1005 R27□-T	RoHS	0.27	$\pm 10\%$, $\pm 20\%$	10	120	0.91	25	25	0.50 ± 0.05
LK 1005 R33□-T	RoHS	0.33	$\pm 10\%$, $\pm 20\%$	10	105	1.05	25	25	0.50 ± 0.05
LK 1005 R39□-T	RoHS	0.39	$\pm 10\%$, $\pm 20\%$	20	85	0.41	20	10	0.50 ± 0.05
LK 1005 R47□-T	RoHS	0.47	$\pm 10\%$, $\pm 20\%$	20	80	0.42	20	10	0.50 ± 0.05
LK 1005 R56□-T	RoHS	0.56	$\pm 10\%$, $\pm 20\%$	20	75	0.47	20	10	0.50 ± 0.05
LK 1005 R68□-T	RoHS	0.68	$\pm 10\%$, $\pm 20\%$	20	70	0.55	20	10	0.50 ± 0.05
LK 1005 R82□-T	RoHS	0.82	$\pm 10\%$, $\pm 20\%$	20	65	0.59	20	10	0.50 ± 0.05
LK 1005 1R0□-T	RoHS	1.0	$\pm 10\%$, $\pm 20\%$	20	60	0.64	20	10	0.50 ± 0.05
LK 1005 1R2□-T	RoHS	1.2	$\pm 10\%$, $\pm 20\%$	20	55	0.79	20	10	0.50 ± 0.05
LK 1005 1R5□-T	RoHS	1.5	$\pm 10\%$, $\pm 20\%$	20	50	0.95	20	10	0.50 ± 0.05
LK 1005 1R8□-T	RoHS	1.8	$\pm 10\%$, $\pm 20\%$	20	45	1.16	20	10	0.50 ± 0.05
LK 1005 2R2□-T	RoHS	2.2	$\pm 10\%$, $\pm 20\%$	20	40	1.15	20	10	0.50 ± 0.05

※ □ mark indicates the Inductance tolerance code.

● LK1608

Parts number	EHS	Nominal inductance [μ H]	Inductance tolerance	Q (min.)	Self-resonant frequency [MHz] (min.)	DC Resistance [Ω] (max.)	Rated current [mA] (max.)	Measuring frequency [MHz]	Thickness [mm]
LK 1608 47NM-T	RoHS	0.047	$\pm 20\%$	10	260	0.20	150	50	0.80 ± 0.15
LK 1608 68NM-T	RoHS	0.068	$\pm 20\%$	10	250	0.30	150	50	0.80 ± 0.15
LK 1608 82NM-T	RoHS	0.082	$\pm 20\%$	10	245	0.30	150	50	0.80 ± 0.15
LK 1608 R10□-T	RoHS	0.10	$\pm 10\%$, $\pm 20\%$	15	240	0.35	150	25	0.80 ± 0.15
LK 1608 R12□-T	RoHS	0.12	$\pm 10\%$, $\pm 20\%$	15	205	0.40	150	25	0.80 ± 0.15
LK 1608 R15□-T	RoHS	0.15	$\pm 10\%$, $\pm 20\%$	15	180	0.45	150	25	0.80 ± 0.15
LK 1608 R18□-T	RoHS	0.18	$\pm 10\%$, $\pm 20\%$	15	165	0.50	100	25	0.80 ± 0.15
LK 1608 R22□-T	RoHS	0.22	$\pm 10\%$, $\pm 20\%$	15	150	0.55	100	25	0.80 ± 0.15
LK 1608 R27□-T	RoHS	0.27	$\pm 10\%$, $\pm 20\%$	15	136	0.80	100	25	0.80 ± 0.15
LK 1608 R33□-T	RoHS	0.33	$\pm 10\%$, $\pm 20\%$	15	125	0.75	80	25	0.80 ± 0.15
LK 1608 R39□-T	RoHS	0.39	$\pm 10\%$, $\pm 20\%$	15	110	0.85	80	25	0.80 ± 0.15
LK 1608 R47□-T	RoHS	0.47	$\pm 10\%$, $\pm 20\%$	15	105	0.95	80	25	0.80 ± 0.15
LK 1608 R56□-T	RoHS	0.56	$\pm 10\%$, $\pm 20\%$	15	95	1.05	80	25	0.80 ± 0.15
LK 1608 R68□-T	RoHS	0.68	$\pm 10\%$, $\pm 20\%$	15	80	1.25	40	25	0.80 ± 0.15
LK 1608 R82□-T	RoHS	0.82	$\pm 10\%$, $\pm 20\%$	15	75	1.40	40	25	0.80 ± 0.15
LK 1608 1R0□-T	RoHS	1.0	$\pm 10\%$, $\pm 20\%$	35	70	0.60	40	10	0.80 ± 0.15
LK 1608 1R2□-T	RoHS	1.2	$\pm 10\%$, $\pm 20\%$	35	60	0.65	40	10	0.80 ± 0.15
LK 1608 1R5□-T	RoHS	1.5	$\pm 10\%$, $\pm 20\%$	35	55	0.70	40	10	0.80 ± 0.15
LK 1608 1R8□-T	RoHS	1.8	$\pm 10\%$, $\pm 20\%$	35	50	0.95	40	10	0.80 ± 0.15
LK 1608 2R2□-T	RoHS	2.2	$\pm 10\%$, $\pm 20\%$	35	45	1.00	30	10	0.80 ± 0.15
LK 1608 2R7□-T	RoHS	2.7	$\pm 10\%$, $\pm 20\%$	35	40	1.15	30	10	0.80 ± 0.15
LK 1608 3R3□-T	RoHS	3.3	$\pm 10\%$, $\pm 20\%$	35	38	1.30	30	10	0.80 ± 0.15
LK 1608 3R9□-T	RoHS	3.9	$\pm 10\%$, $\pm 20\%$	35	36	1.50	30	10	0.80 ± 0.15
LK 1608 4R7□-T	RoHS	4.7	$\pm 10\%$, $\pm 20\%$	35	33	1.60	30	10	0.80 ± 0.15
LK 1608 5R6□-T	RoHS	5.6	$\pm 10\%$, $\pm 20\%$	35	22	1.10	10	4	0.80 ± 0.15
LK 1608 6R8□-T	RoHS	6.8	$\pm 10\%$, $\pm 20\%$	35	20	1.30	10	4	0.80 ± 0.15
LK 1608 8R2□-T	RoHS	8.2	$\pm 10\%$, $\pm 20\%$	35	18	1.50	10	4	0.80 ± 0.15
LK 1608 100□-T	RoHS	10	$\pm 10\%$, $\pm 20\%$	35	17	1.70	10	2	0.80 ± 0.15
LK 1608 120□-T	RoHS	12	$\pm 10\%$, $\pm 20\%$	35	15	1.80	10	2	0.80 ± 0.15
LK 1608 150M-T	RoHS	15	$\pm 20\%$	20	14	1.50	1	1	0.80 ± 0.15
LK 1608 180M-T	RoHS	18	$\pm 20\%$	20	13	1.60	1	1	0.80 ± 0.15
LK 1608 220M-T	RoHS	22	$\pm 20\%$	20	11	1.70	1	1	0.80 ± 0.15
LK 1608 270M-T	RoHS	27	$\pm 20\%$	20	10	1.80	1	1	0.80 ± 0.15
LK 1608 330M-T	RoHS	33	$\pm 20\%$	20	9	2.20	1	1	0.80 ± 0.15

※ □ mark indicates the Inductance tolerance code.

LK2125

Parts number	EHS	Nominal inductance [μ H]	Inductance tolerance	Q (min.)	Self-resonant frequency [MHz] (min.)	DC Resistance [Ω] (max.)	Rated current [mA] (max.)	Measuring frequency [MHz]	Thickness [mm]
LK 2125 47NM-T	RoHS	0.047	$\pm 20\%$	15	320	0.10	300	50	0.85 ± 0.2
LK 2125 68NM-T	RoHS	0.068	$\pm 20\%$	15	280	0.15	300	50	0.85 ± 0.2
LK 2125 82NM-T	RoHS	0.082	$\pm 20\%$	15	255	0.20	300	50	0.85 ± 0.2
LK 2125 R10-T	RoHS	0.10	$\pm 10\%$, $\pm 20\%$	20	235	0.15	270	25	0.85 ± 0.2
LK 2125 R12-T	RoHS	0.12	$\pm 10\%$, $\pm 20\%$	20	220	0.20	270	25	0.85 ± 0.2
LK 2125 R15-T	RoHS	0.15	$\pm 10\%$, $\pm 20\%$	20	200	0.20	270	25	0.85 ± 0.2
LK 2125 R18-T	RoHS	0.18	$\pm 10\%$, $\pm 20\%$	20	185	0.25	270	25	0.85 ± 0.2
LK 2125 R22-T	RoHS	0.22	$\pm 10\%$, $\pm 20\%$	20	170	0.30	250	25	0.85 ± 0.2
LK 2125 R27-T	RoHS	0.27	$\pm 10\%$, $\pm 20\%$	20	150	0.35	250	25	0.85 ± 0.2
LK 2125 R33-T	RoHS	0.33	$\pm 10\%$, $\pm 20\%$	20	145	0.40	250	25	0.85 ± 0.2
LK 2125 R39-T	RoHS	0.39	$\pm 10\%$, $\pm 20\%$	25	135	0.45	200	25	0.85 ± 0.2
LK 2125 R47-T	RoHS	0.47	$\pm 10\%$, $\pm 20\%$	25	125	0.50	200	25	1.25 ± 0.2
LK 2125 R56-T	RoHS	0.56	$\pm 10\%$, $\pm 20\%$	25	115	0.55	150	25	1.25 ± 0.2
LK 2125 R68-T	RoHS	0.68	$\pm 10\%$, $\pm 20\%$	25	105	0.60	150	25	1.25 ± 0.2
LK 2125 R82-T	RoHS	0.82	$\pm 10\%$, $\pm 20\%$	25	100	0.65	150	25	1.25 ± 0.2
LK 2125 1R0-T	RoHS	1.0	$\pm 10\%$, $\pm 20\%$	45	75	0.30	80	10	0.85 ± 0.2
LK 2125 1R2-T	RoHS	1.2	$\pm 10\%$, $\pm 20\%$	45	65	0.35	80	10	0.85 ± 0.2
LK 2125 1R5-T	RoHS	1.5	$\pm 10\%$, $\pm 20\%$	45	60	0.40	80	10	0.85 ± 0.2
LK 2125 1R8-T	RoHS	1.8	$\pm 10\%$, $\pm 20\%$	45	55	0.45	80	10	0.85 ± 0.2
LK 2125 2R2-T	RoHS	2.2	$\pm 10\%$, $\pm 20\%$	45	50	0.50	50	10	0.85 ± 0.2
LK 2125 2R7-T	RoHS	2.7	$\pm 10\%$, $\pm 20\%$	45	45	0.55	50	10	1.25 ± 0.2
LK 2125 3R3-T	RoHS	3.3	$\pm 10\%$, $\pm 20\%$	45	41	0.60	50	10	1.25 ± 0.2
LK 2125 3R9-T	RoHS	3.9	$\pm 10\%$, $\pm 20\%$	45	38	0.70	30	10	1.25 ± 0.2
LK 2125 4R7-T	RoHS	4.7	$\pm 10\%$, $\pm 20\%$	45	35	0.70	30	10	1.25 ± 0.2
LK 2125 5R6-T	RoHS	5.6	$\pm 10\%$, $\pm 20\%$	50	32	0.60	15	4	1.25 ± 0.2
LK 2125 6R8-T	RoHS	6.8	$\pm 10\%$, $\pm 20\%$	50	29	0.70	15	4	1.25 ± 0.2
LK 2125 8R2-T	RoHS	8.2	$\pm 10\%$, $\pm 20\%$	50	26	0.70	15	4	1.25 ± 0.2
LK 2125 100-T	RoHS	10	$\pm 10\%$, $\pm 20\%$	50	24	0.80	15	2	1.25 ± 0.2
LK 2125 120-T	RoHS	12	$\pm 10\%$, $\pm 20\%$	50	22	0.90	15	2	1.25 ± 0.2
LK 2125 150M-T	RoHS	15	$\pm 20\%$	30	19	0.70	5	1	1.25 ± 0.2
LK 2125 180M-T	RoHS	18	$\pm 20\%$	30	18	0.80	5	1	1.25 ± 0.2
LK 2125 220M-T	RoHS	22	$\pm 20\%$	30	16	0.90	5	1	1.25 ± 0.2
LK 2125 270M-T	RoHS	27	$\pm 20\%$	30	14	1.00	5	1	1.25 ± 0.2
LK 2125 330M-T	RoHS	33	$\pm 20\%$	30	13	1.10	5	0.4	1.25 ± 0.2

※ □ mark indicates the Inductance tolerance code.

MULTILAYER CHIP INDUCTORS(CK SERIES / CK SERIES S TYPE)



WAVE

REFLOW

PARTS NUMBER

* Operating Temp.: -40~+85°C

C	K	△	2	1	2	5	△	1	R	0	M	-	T	△
①	②		③			④	⑤	⑥						

△=Blank space

①Series name

Code	Series name
CK△	Multilayer chip inductor
CKS	

②Dimensions (L × W)

Code	Type (inch)	Dimensions (L × W) [mm]
1608	1608 (0603)	1.6 × 0.8
2125	2125 (0805)	2.0 × 1.25

③Nominal inductance

Code (example)	Nominal inductance [μH]
1R0	1.0
100	10

※R=Decimal point

④Inductance tolerance

Code	Inductance tolerance
M	±20%

⑤Packaging

Code	Packaging
-T	Taping

⑥Internal code

Code	Internal code
△	Standard

STANDARD EXTERNAL DIMENSIONS / STANDARD QUANTITY

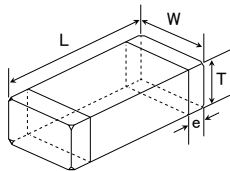

Type	L	W	T	e	Standard quantity [pcs]	
					Paper tape	Embossed tape
CK 1608 (0603)	1.6±0.15 (0.063±0.006)	0.8±0.15 (0.031±0.006)	0.8±0.15 (0.031±0.006)	0.3±0.2 (0.012±0.008)	4000	—
CK 2125 CKS2125 (0805)	2.0+0.3/-0.1 (0.079+0.012/-0.004)	1.25±0.2 (0.049±0.008)	0.85±0.2 (0.033±0.008)	0.5±0.3 (0.020±0.012)	4000	—
	2.0+0.3/-0.1 (0.079+0.012/-0.004)	1.25±0.2 (0.049±0.008)	1.25±0.2 (0.049±0.008)	0.5±0.3 (0.020±0.012)	—	2000

Unit: mm (inch)

PARTS NUMBER

●CK1608

Parts number	EHS	Nominal inductance [μH]	Inductance tolerance	Self-resonant frequency [MHz] (min.)	DC Resistance [Ω] (±30%)	Rated current [mA] (max.)	Measuring frequency [MHz]	Thickness [mm]
CK 1608 4R7M-T	RoHS	4.7	±20%	25	0.45	60	4	0.80 ±0.15
CK 1608 100M-T	RoHS	10.0	±20%	17	0.85	50	2	0.80 ±0.15

●CK2125

Parts number	EHS	Nominal inductance [μH]	Inductance tolerance	Self-resonant frequency [MHz] (min.)	DC Resistance [Ω]		Rated current [mA] (max.)	Measuring frequency [MHz]	Thickness [mm]
					(max.)	(typ.)			
CK 2125 R10M-T	RoHS	0.10	±20%	235	0.16	0.08	500	25	0.85 ±0.2
CK 2125 R15M-T	RoHS	0.15	±20%	200	0.20	0.13	500	25	0.85 ±0.2
CK 2125 R22M-T	RoHS	0.22	±20%	170	0.23	0.16	400	25	0.85 ±0.2
CK 2125 R33M-T	RoHS	0.33	±20%	145	0.28	0.21	400	25	0.85 ±0.2
CK 2125 R47M-T	RoHS	0.47	±20%	125	0.32	0.25	400	25	1.25 ±0.2
CK 2125 R68M-T	RoHS	0.68	±20%	105	0.45	0.35	300	25	1.25 ±0.2
CK 2125 1R0M-T	RoHS	1.0	±20%	75	0.26	0.19	220	10	0.85 ±0.2
CK 2125 1R5M-T	RoHS	1.5	±20%	60	0.28	0.23	170	10	0.85 ±0.2
CK 2125 2R2M-T	RoHS	2.2	±20%	50	0.35	0.26	150	10	0.85 ±0.2
CK 2125 3R3M-T	RoHS	3.3	±20%	41	0.43	0.38	130	10	1.25 ±0.2
CK 2125 4R7M-T	RoHS	4.7	±20%	35	0.48	0.44	120	10	1.25 ±0.2
CK 2125 6R8M-T	RoHS	6.8	±20%	29	0.52	0.39	70	4	1.25 ±0.2
CK 2125 100M-T	RoHS	10.0	±20%	24	0.65	0.55	60	2	1.25 ±0.2

●CKS2125

Parts number	EHS	Nominal inductance [μH]	Inductance tolerance	Self-resonant frequency [MHz] (min.)	DC Resistance [Ω]		Rated current [mA] (max.)	Measuring frequency [MHz]	Thickness [mm]
					(max.)	(typ.)			
CKS2125 1R0M-T	RoHS	1.0	±20%	75	0.12	0.09	280	10	0.85 ±0.2
CKS2125 2R2M-T	RoHS	2.2	±20%	50	0.19	0.15	170	10	0.85 ±0.2
CKS2125 4R7M-T	RoHS	4.7	±20%	35	0.30	0.25	130	10	1.25 ±0.2
CKS2125 100M-T	RoHS	10.0	±20%	24	0.52	0.40	110	2	1.25 ±0.2

▶ This catalog contains the typical specification only due to the limitation of space. When you consider the purchase of our products, please check our product specification sheets. For details of each product (characteristics graph, reliability information, precautions for use, and so on), see our website (<http://www.ty-top.com/>).

Multilayer chip inductors

Multilayer chip inductors for high frequency, Multilayer chip bead inductors

Multilayer common mode choke coils (MC series F type)

Metal Multilayer Chip Power Inductors (MCOIL™ MC series)

PACKAGING

① Minimum Quantity

● Tape & Reel Packaging

Type	Thickness mm (inch)	Standard Quantity [pcs]	
		Paper Tape	Embossed Tape
CK1608(0603)	0.8 (0.031)	4000	—
CK2125(0805)	0.85(0.033)	4000	—
	1.25(0.049)	—	2000
CKS2125(0805)	0.85(0.033)	4000	—
	1.25(0.049)	—	2000
CKP1608(0603)	0.8 (0.031)	4000	—
CKP2012(0805)	0.9 (0.035)	—	3000
CKP2016(0806)	0.9 (0.035)	—	3000
CKP2520(1008)	0.7 (0.028)	—	3000
	0.9 (0.035)	—	3000
	1.1 (0.043)	—	2000
LK1005(0402)	0.5 (0.020)	10000	—
LK1608(0603)	0.8 (0.031)	4000	—
LK2125(0805)	0.85(0.033)	4000	—
	1.25(0.049)	—	2000
HK0603(0201)	0.3 (0.012)	15000	—
HK1005(0402)	0.5 (0.020)	10000	—
HK1608(0603)	0.8 (0.031)	4000	—
HK2125(0805)	0.85(0.033)	—	4000
	1.0 (0.039)	—	3000
HKQ0603W(0201)	0.3 (0.012)	15000	—
HKQ0603S(0201)	0.3 (0.012)	15000	—
HKQ0603U(0201)	0.3 (0.012)	15000	—
AQ105(0402)	0.5 (0.020)	10000	—
BK0603(0201)	0.3 (0.012)	15000	—
BK1005(0402)	0.5 (0.020)	10000	—
BKH0603(0201)	0.3 (0.012)	15000	—
BKH1005(0402)	0.5 (0.020)	10000	—
BK1608(0603)	0.8 (0.031)	4000	—
BK2125(0805)	0.85(0.033)	4000	—
	1.25(0.049)	—	2000
BK2010(0804)	0.45(0.018)	4000	—
BK3216(1206)	0.8 (0.031)	—	4000
BKP0603(0201)	0.3 (0.012)	15000	—
BKP1005(0402)	0.5 (0.020)	10000	—
BKP1608(0603)	0.8 (0.031)	4000	—
BKP2125(0805)	0.85(0.033)	4000	—
MCF0605(0202)	0.3 (0.012)	15000	—
MCF0806(0302)	0.4 (0.016)	—	10000
MCF1210(0504)	0.55(0.022)	—	5000
MCF2010(0804)	0.45(0.018)	—	4000
MCEE1005(0402)	0.55(0.022)	10000	—
MCFK1608(0603)	0.6 (0.024)	4000	—
MCFE1608(0603)	0.65(0.026)	4000	—
MCKK1608(0603)	1.0 (0.039)	—	3000
MCHK2012(0806)	0.8 (0.031)	4000	—
MCKK2012(0805)	1.0 (0.039)	—	3000

▶ This catalog contains the typical specification only due to the limitation of space. When you consider the purchase of our products, please check our specification. For details of each product (characteristics graph, reliability information, precautions for use, and so on), see our Web site (<http://www.ty-top.com/>).

② Taping material

● Card board carrier tape



CK	1608
CKP	1608
CK	2125
CKS	2125
LK	1005
LK	1608
LK	2125
HK	0603
HK	1005
HK	1608
HKQ	0603
AQ	105

BK	0603
BK	1005
BK	1608
BK	2125
BK	2010
BKP	0603
BKP	1005
BKP	1608
BKP	2125
BKH	0603
BKH	1005
MCF	0605
MC	1005
MC	1608
MC	2012



● Embossed Tape



CK	2125
CKS	2125
CKP	2012
CKP	2016
CKP	2520
LK	2125
HK	2125

BK	2125
BK	3216
MCF	0806
MCF	1210
MCF	2010
MC	1608
MC	2012



③ Taping Dimensions

● Paper tape (8mm wide)

Unit: mm (inch)



▶ This catalog contains the typical specification only due to the limitation of space. When you consider the purchase of our products, please check our specification. For details of each product (characteristics graph, reliability information, precautions for use, and so on), see our Web site (<http://www.ty-top.com/>).

Type	Thickness mm (inch)	Chip cavity		Insertion Pitch	Tape Thickness
		A	B	F	T
CK1608(0603)	0.8 (0.031)	1.0±0.2 (0.039±0.008)	1.8±0.2 (0.071±0.008)	4.0±0.1 (0.157±0.004)	1.1max (0.043max)
CK2125(0805)	0.85(0.033)	1.5±0.2 (0.059±0.008)	2.3±0.2 (0.091±0.008)	4.0±0.1 (0.157±0.004)	1.1max (0.043max)
CKS2125(0805)	0.85(0.033)	1.5±0.2 (0.059±0.008)	2.3±0.2 (0.091±0.008)	4.0±0.1 (0.157±0.004)	1.1max (0.043max)
CKP1608(0603)	0.8 (0.031)	1.0±0.2 (0.039±0.008)	1.8±0.2 (0.071±0.008)	4.0±0.1 (0.157±0.004)	1.1max (0.043max)
LK1005(0402)	0.5 (0.020)	0.65±0.1 (0.026±0.004)	1.15±0.1 (0.045±0.004)	2.0±0.05 (0.079±0.002)	0.8max (0.031max)
LK1608(0603)	0.8 (0.031)	1.0±0.2 (0.039±0.008)	1.8±0.2 (0.071±0.008)	4.0±0.1 (0.157±0.004)	1.1max (0.043max)
LK2125(0805)	0.85(0.033)	1.5±0.2 (0.059±0.008)	2.3±0.2 (0.091±0.008)	4.0±0.1 (0.157±0.004)	1.1max (0.043max)
HK0603(0201)	0.3 (0.012)	0.40±0.06 (0.016±0.002)	0.70±0.06 (0.028±0.002)	2.0±0.05 (0.079±0.002)	0.45max (0.018max)
HK1005(0402)	0.5 (0.020)	0.65±0.1 (0.026±0.004)	1.15±0.1 (0.045±0.004)	2.0±0.05 (0.079±0.002)	0.8max (0.031max)
HK1608(0603)	0.8 (0.031)	1.0±0.2 (0.039±0.008)	1.8±0.2 (0.071±0.008)	4.0±0.1 (0.157±0.004)	1.1max (0.043max)
HKQ0603W(0201)	0.3 (0.012)	0.40±0.06 (0.016±0.002)	0.70±0.06 (0.028±0.002)	2.0±0.05 (0.079±0.002)	0.45max (0.018max)
HKQ0603S(0201)	0.3 (0.012)	0.40±0.06 (0.016±0.002)	0.70±0.06 (0.028±0.002)	2.0±0.05 (0.079±0.002)	0.45max (0.018max)
HKQ0603U(0201)	0.3 (0.012)	0.40±0.06 (0.016±0.002)	0.70±0.06 (0.028±0.002)	2.0±0.05 (0.079±0.002)	0.45max (0.018max)
AQ105(0402)	0.5 (0.020)	0.75±0.1 (0.030±0.004)	1.15±0.1 (0.045±0.004)	2.0±0.05 (0.079±0.002)	0.8max (0.031max)
BK0603(0201)	0.3 (0.012)	0.40±0.06 (0.016±0.002)	0.70±0.06 (0.028±0.002)	2.0±0.05 (0.079±0.002)	0.45max (0.018max)
BK1005(0402)	0.5 (0.020)	0.65±0.1 (0.026±0.004)	1.15±0.1 (0.045±0.004)	2.0±0.05 (0.079±0.002)	0.8max (0.031max)
BK1608(0603)	0.8 (0.031)	1.0±0.2 (0.039±0.008)	1.8±0.2 (0.071±0.008)	4.0±0.1 (0.157±0.004)	1.1max (0.043max)
BK2125(0805)	0.85(0.033)	1.5±0.2 (0.059±0.008)	2.3±0.2 (0.091±0.008)	4.0±0.1 (0.157±0.004)	1.1max (0.043max)
BK2010(0804)	0.45(0.018)	1.2±0.1 (0.047±0.004)	2.17±0.1 (0.085±0.004)	4.0±0.1 (0.157±0.004)	0.8max (0.031max)
BKP0603(0201)	0.3 (0.012)	0.40±0.06 (0.016±0.002)	0.70±0.06 (0.028±0.002)	2.0±0.05 (0.079±0.002)	0.45max (0.018max)
BKP1005(0402)	0.5 (0.020)	0.65±0.1 (0.026±0.004)	1.15±0.1 (0.045±0.004)	2.0±0.05 (0.079±0.002)	0.8max (0.031max)
BKP1608(0603)	0.8 (0.031)	1.0±0.2 (0.039±0.008)	1.8±0.2 (0.071±0.008)	4.0±0.1 (0.157±0.004)	1.1max (0.043max)
BKP2125(0805)	0.85(0.033)	1.5±0.2 (0.059±0.008)	2.3±0.2 (0.091±0.008)	4.0±0.1 (0.157±0.004)	1.1max (0.043max)
BKH0603(0201)	0.3 (0.012)	0.40±0.06 (0.016±0.002)	0.70±0.06 (0.028±0.002)	2.0±0.05 (0.079±0.002)	0.45max (0.018max)
BKH1005(0402)	0.5 (0.020)	0.65±0.1 (0.026±0.004)	1.15±0.1 (0.045±0.004)	2.0±0.05 (0.079±0.002)	0.8max (0.031max)
MCF0605(0202)	0.3 (0.012)	0.62±0.03 (0.024±0.001)	0.77±0.03 (0.030±0.001)	2.0±0.05 (0.079±0.002)	0.45max (0.018max)
MCFK1608(0603)	0.6 (0.024)	1.1±0.05 (0.043±0.002)	1.9±0.05 (0.075±0.002)	4.0±0.1 (0.157±0.004)	0.72max (0.028max)
MCEE1005(0402)	0.55(0.021)	0.8±0.05 (0.031±0.002)	1.3±0.05 (0.051±0.002)	2.0±0.05 (0.079±0.002)	0.6max (0.016max)
MCFE1608(0603)	0.65(0.026)	1.1±0.05 (0.043±0.002)	1.9±0.05 (0.075±0.002)	4.0±0.1 (0.157±0.004)	0.9max (0.035max)
MCHK2012(0805)	0.8 (0.031)	1.55±0.2 (0.061±0.008)	2.3±0.2 (0.091±0.008)	4.0±0.1 (0.157±0.004)	0.9max (0.035max)

Unit : mm (inch)

● Embossed Tape (8mm wide)



Type	Thickness mm (inch)	Chip cavity		Insertion Pitch	Tape Thickness	
		A	B	F	K	T
CK2125(0805)	1.25 (0.049)	1.5 ± 0.2 (0.059 ± 0.008)	2.3 ± 0.2 (0.091 ± 0.008)	4.0 ± 0.1 (0.157 ± 0.004)	2.0 (0.079)	0.3 (0.012)
CKS2125(0805)	1.25 (0.049)	1.5 ± 0.2 (0.059 ± 0.008)	2.3 ± 0.2 (0.091 ± 0.008)	4.0 ± 0.1 (0.157 ± 0.004)	2.0 (0.079)	0.3 (0.012)
CKP2012(0805)	0.9 (0.035)	1.55 ± 0.2 (0.061 ± 0.008)	2.3 ± 0.2 (0.091 ± 0.008)	4.0 ± 0.1 (0.157 ± 0.004)	1.3 (0.051)	0.3 (0.012)
CKP2016(0806)	0.9 (0.035)	1.8 ± 0.1 (0.071 ± 0.004)	2.2 ± 0.1 (0.087 ± 0.004)	4.0 ± 0.1 (0.157 ± 0.004)	1.3 (0.051)	0.25 (0.01)
CKP2520(1008)	0.7 (0.028)	2.3 ± 0.1 (0.091 ± 0.004)	2.8 ± 0.1 (0.110 ± 0.004)	4.0 ± 0.1 (0.157 ± 0.004)	1.4 (0.055)	0.3 (0.012)
	0.9 (0.035)				1.4 (0.055)	
	1.1 (0.043)				1.7 (0.067)	
	1.1 (0.043)				1.7 (0.067)	
LK2125(0805)	1.25 (0.049)	1.5 ± 0.2 (0.059 ± 0.008)	2.3 ± 0.2 (0.091 ± 0.008)	4.0 ± 0.1 (0.157 ± 0.004)	2.0 (0.079)	0.3 (0.012)
HK2125(0805)	0.85 (0.033)	1.5 ± 0.2 (0.059 ± 0.008)	2.3 ± 0.2 (0.091 ± 0.008)	4.0 ± 0.1 (0.157 ± 0.004)	1.5 (0.059)	0.3 (0.012)
	1.0 (0.039)				2.0 (0.079)	
BK2125(0805)	1.25 (0.049)	1.5 ± 0.2 (0.059 ± 0.008)	2.3 ± 0.2 (0.091 ± 0.008)	4.0 ± 0.1 (0.157 ± 0.004)	2.0 (0.079)	0.3 (0.012)
BK3216(1206)	0.8 (0.031)	1.9 ± 0.1 (0.075 ± 0.004)	3.5 ± 0.1 (0.138 ± 0.004)	4.0 ± 0.1 (0.157 ± 0.004)	1.4 (0.055)	0.3 (0.012)
MCF0806(0302)	0.4 (0.016)	0.75 ± 0.05 (0.030 ± 0.002)	0.95 ± 0.05 (0.037 ± 0.002)	2.0 ± 0.05 (0.079 ± 0.002)	0.55 (0.022)	0.3 (0.012)
MCF1210(0504)	0.55 (0.022)	1.15 ± 0.05 (0.045 ± 0.002)	1.40 ± 0.05 (0.055 ± 0.002)	4.0 ± 0.1 (0.157 ± 0.004)	0.65 (0.026)	0.3 (0.012)
MCF2010(0804)	0.45 (0.018)	1.1 ± 0.1 (0.043 ± 0.004)	2.3 ± 0.1 (0.091 ± 0.004)	4.0 ± 0.1 (0.157 ± 0.004)	0.85 (0.033)	0.3 (0.012)
MCKK1608(0603)	1.0 (0.039)	1.1 ± 0.1 (0.043 ± 0.004)	1.95 ± 0.1 (± 0.004)	4.0 ± 0.1 (0.157 ± 0.004)	1.4 (0.055)	0.25 (0.01)
MCKK2012(0805)	1.0 (0.039)	1.55 ± 0.2 (0.061 ± 0.008)	2.3 ± 0.2 (0.091 ± 0.008)	4.0 ± 0.1 (0.157 ± 0.004)	1.35 (0.053)	0.25 (0.010)

Unit : mm (inch)

④ LEADER AND BLANK PORTION



⑤ Reel Size



A	B	C	D	E	R
$\phi 178 \pm 2.0$	$\phi 60$ or more	$\phi 13.0 \pm 0.2$	$\phi 21.0 \pm 0.8$	2.0 ± 0.5	1.0

	t	W
4mm width tape	1.5max.	5 ± 1.0
8mm width tape	2.5max.	10 ± 1.5

(Unit : mm)

⑥ Top tape strength

The top tape requires a peel-off force of 0.1~0.7N in the direction of the arrow as illustrated below.



Multilayer chip inductors

Multilayer chip inductors for high frequency, Multilayer chip bead inductors

Multilayer common mode choke coils (MC series F type)

Metal Multilayer Chip Power Inductors (MCOIL™ MC series)

RELIABILITY DATA

1. Operating Temperature Range		
Specified Value	BK series	-55~+125°C
	BKH series	
	BKP series	-55~+85°C
	MCF series	-40~+85°C
	CK series	-40~+85°C
	CKS series	
	CKP series	
	LK series	
	HK0603, HK1005	-55~+125°C
	HK1608, HK2125	-40~+85°C
	HKQ0603	-55~+125°C
	AQ105	
MCOIL™ MC series	-40~+125°C (Including self-generated heat)	

2. Storage Temperature Range		
Specified Value	BK series	-55~+125°C
	BKH series	
	BKP series	-55~+85°C
	MCF series	-40~+85°C
	CK series	-40~+85°C
	CKS series	
	CKP series	
	LK series	
	HK0603, HK1005	-55~+125°C
	HK1608, HK2125	-40~+85°C
	HKQ0603	-55~+125°C
	AQ105	
MCOIL™ MC series	-40~+85°C	

3. Rated Current		
Specified Value	BK series	The temperature of the element is increased within 20°C.
	BKH series	
	BKP series	The temperature of the element is increased within 40°C
	MCF series	Refer to each specification.
	CK series	The temperature of the element is increased within 20°C.
	CKS series	
	CKP series	
	LK series	
	HK0603, HK1005	The decreasing-rate of inductance value is within 5 %
	HK1608, HK2125	
	HKQ0603	
	AQ105	
MCOIL™ MC series	Idc1: The decreasing-rate of inductance value is within 30 % Idc2: The temperature of the element is increased within 40°C	

► This catalog contains the typical specification only due to the limitation of space. When you consider the purchase of our products, please check our specification.
For details of each product (characteristics graph, reliability information, precautions for use, and so on), see our Web site (<http://www.ty-top.com/>).

4. Impedance		
Specified Value	BK series	Refer to each specification.
	BKH series	
	BKP series	
	MCF series	
Test Methods and Remarks	BK0603Series, BKP0603Series, BKH Series	Measuring frequency : 100±1MHz Measuring equipment : 4991A (or its equivalent) Measuring jig : 16193A (or its equivalent)
	BK1005Series, BKP1005Series, BKH1005Series	Measuring frequency : 100±1MHz Measuring equipment : 4291A (or its equivalent) Measuring jig : 16192A (or its equivalent), HW:16193A (or its equivalent)
	BK1608・2125Series, BKP1608・2125Series	Measuring frequency : 100±1MHz Measuring equipment : 4291A (or its equivalent), 4195A (or its equivalent) Measuring jig : 16092A (or its equivalent), HW:16192A (or its equivalent)
	BK2010・3216Series	Measuring frequency : 100±1MHz Measuring equipment : 4291A (or its equivalent), 4195A (or its equivalent) Measuring jig : 16192A (or its equivalent)
	MCF Series	Measuring frequency : 100±1MHz Measuring equipment : 4291A (or its equivalent)

5. Inductance		
Specified Value	CK series	Refer to each specification.
	CKS series	
	CKP series	
	LK series	
	HK0603, HK1005	
	HK1608, HK2125	
	HKQ0603	
	AQ105	
Test Methods and Remarks	MCOIL™ MC series	
	CK, CKS, LK Series	Measuring frequency : Refer to each specification. Measuring equipment /jig : 1608,2125⇒4194A+16085B+16092A (or its equivalent), 4195A+41951+16092A (or its equivalent) 1005⇒4291A+16193A (or its equivalent) Measuring current : 047~4.7 μH ⇒1mArms, 5.6~33 μH ⇒0.1mArms
	CKP, MCOIL™ MC Series	Measuring frequency : 1MHz Measuring equipment : 4285A (or its equivalent)
	HK0603, HK1005, AQ Series	Measuring frequency : 100MHz Measuring equipment /jig : HK0603・AQ105⇒4291A+16197A (or its equivalent) HK1005⇒4291A+16193A (or its equivalent)
	HK1608, HK2125 Series	Measuring frequency : ~100nH⇒100MHz, 120nH⇒50MHz Measuring equipment /jig : 4195A+16092A (or its equivalent)
	HKQ Series	Measuring frequency : HKQ0603S・HKQ0603U⇒500MHz Measuring frequency : HKQ0603W⇒300/500MHz Measuring equipment /jig : E4991A+16197A (or its equivalent)

▶ This catalog contains the typical specification only due to the limitation of space. When you consider the purchase of our products, please check our specification. For details of each product (characteristics graph, reliability information, precautions for use, and so on), see our Web site (<http://www.ty-top.com/>).

6. Q

Specified Value	CK series	—	
	CKS series		
	CKP series		
	LK series		
	HK0603, HK1005		Refer to each specification.
	HK1608, HK2125		
	HKQ0603		
	AQ105		
MCOIL™ MC series	—		
Test Methods and Remarks	LK Series		
	Measuring frequency	: Refer to each specification.	
	Measuring equipment /jig	: 1608,2125⇒4194A+16085B+16092A (or its equivalent) 、 4195A+41951+16092A (or its equivalent) 1005⇒4291A+16193A (or its equivalent)	
	Measuring current	: 047~4.7 μH ⇒1mArms 、 5.6~33 μH ⇒0.1mArms	
	HK0603, HK1005, AQ Series		
	Measuring frequency	: 100MHz	
	Measuring equipment /jig	: HK0603・AQ105⇒4291A+16197A (or its equivalent) HK1005⇒4291A+16193A (or its equivalent)	
	HK1608, HK2125 Series		
	Measuring frequency	: ~100nH⇒100MHz 、 120nH~⇒50MHz	
	Measuring equipment /jig	: 4195A+16092A (or its equivalent)	
HKQ Series			
Measuring frequency	: HKQ0603S・HKQ0603U⇒ 500MHz		
Measuring frequency	: HKQ0603W⇒ 300/500MHz		
Measuring equipment /jig	: E4991A+16197A (or its equivalent)		

7. DC Resistance

Specified Value	BK series	Refer to each specification.
	BKH series	
	BKP series	
	MCF series	
	CK series	
	CKS series	
	CKP series	
	LK series	
	HK0603, HK1005	
	HK1608, HK2125	
	HKQ0603	
	AQ105	
MCOIL™ MC series	—	
Test Methods and Remarks	Measuring equipment: VOAC-7412, VOAC-7512, VOAC-7521 (made by Iwasaki Tsushinki), HIOKI3227 (or its equivalent)	

8. Self Resonance Frequency (SRF)

Specified Value	BK series	—	
	BKH series		
	BKP series		
	MCF series		
	CK series		Refer to each specification.
	CKS series		
	CKP series		—
	LK series		Refer to each specification.
	HK0603, HK1005		
	HK1608, HK2125		
	HKQ0603		
	AQ105		
MCOIL™ MC series	—		
Test Methods and Remarks	LK, CK Series :		
	Measuring equipment	: 4195A (or its equivalent)	
	Measuring jig	: 41951 + 16092A (or its equivalent)	
	HK, HKQ, AQ Series :		
Measuring equipment	: 8719C (or its equivalent) ・8753D (or its equivalent) /HK2125		

▶ This catalog contains the typical specification only due to the limitation of space. When you consider the purchase of our products, please check our specification. For details of each product (characteristics graph, reliability information, precautions for use, and so on), see our Web site (<http://www.ty-top.com/>).

9. Temperature Characteristic		
Specified Value	BK series	—
	BKH series	
	BKP series	
	MCF series	
	CK series	
	CKS series	
	CKP series	
	LK series	
	HK0603, HK1005	
	HK1608, HK2125	
	HKQ0603	
	AQ105	
	MCOIL™ MC series	
	HK0603, HK1005	
HK1608, HK2125		
HKQ0603		
AQ105	Inductance change: Within ±15%	
MCOIL™ MC series		
Test Methods and Remarks	HK, HKQ, AQ Series: Temperature range : -30~+85°C Reference temperature : +20°C MCOIL™ MC series: Temperature range : -40~+85°C Reference temperature : +20°C	

10. Resistance to Flexure of Substrate		
Specified Value	BK series	No mechanical damage.
	BKH series	
	BKP series	
	MCF series	
	CK series	
	CKS series	
	CKP series	
	LK series	
	HK0603, HK1005	
	HK1608, HK2125	
	HKQ0603	
	AQ105	
	MCOIL™ MC series	
	Test Methods and Remarks	

11. Solderability		
Specified Value	BK series	At least 90% of terminal electrode is covered by new solder.
	BKH series	
	BKP series	
	MCF series	
	CK series	
	CKS series	
	CKP series	
	LK series	
	HK0603, HK1005	
	HK1608, HK2125	
	HKQ0603	
	AQ105	
	MCOIL™ MC series	
	Test Methods and Remarks	

▶ This catalog contains the typical specification only due to the limitation of space. When you consider the purchase of our products, please check our specification. For details of each product (characteristics graph, reliability information, precautions for use, and so on), see our Web site (<http://www.ty-top.com/>).

12. Resistance to Soldering		
Specified Value	BK series	Appearance: No significant abnormality Impedance change: Within $\pm 30\%$
	BKH series	
	BKP series	
	MCF series	Appearance: No significant abnormality Impedance change: Within $\pm 20\%$
	CK series	Appearance: No significant abnormality Inductance change: R10~4R7 \Rightarrow Within $\pm 10\%$, 6R8~100 \Rightarrow Within $\pm 15\%$
	CKS series	Appearance: No significant abnormality Inductance change: Within $\pm 20\%$
	CKP series	Appearance: No significant abnormality Inductance change: Within $\pm 30\%$
	LK series	Appearance: No significant abnormality Inductance change: 1005 \Rightarrow Within $\pm 15\%$ 1608,2125 \Rightarrow 47N~4R7: Within $\pm 10\%$ 5R6~330: Within $\pm 15\%$
	HK0603, HK1005	Appearance: No significant abnormality Inductance change: Within $\pm 5\%$
	HK1608, HK2125	
	HKQ0603	
AQ105		
MCOIL™ MC series	Appearance: No significant abnormality Inductance change: Within $\pm 10\%$	
Test Methods and Remarks	Solder temperature	: $260 \pm 5^\circ\text{C}$
	Duration	: 10 ± 0.5 sec.
	Preheating temperature	: 150 to 180°C
	Preheating time	: 3 min.
	Flux	: Immersion into methanol solution with colophony for 3 to 5 sec.
	Recovery	: 2 to 3 hrs of recovery under the standard condition after the test. (See Note 1)

(Note 1) When there are questions concerning measurement result; measurement shall be made after 48 ± 2 hrs of recovery under the standard condition.

13. Thermal Shock			
Specified Value	BK series	Appearance: No significant abnormality Impedance change: Within $\pm 30\%$	
	BKH series		
	BKP series		
	MCF series	Appearance: No significant abnormality Impedance change: Within $\pm 20\%$	
	CK series	Appearance: No significant abnormality Inductance change: Within $\pm 20\%$	
	CKS series	Appearance: No significant abnormality Inductance change: Within $\pm 20\%$	
	CKP series	Appearance: No significant abnormality Inductance change: Within $\pm 30\%$	
	LK series	Appearance: No significant abnormality Inductance change: Within $\pm 10\%$ Q change: Within $\pm 30\%$	
	HK0603, HK1005	Appearance: No significant abnormality Inductance change: Within $\pm 10\%$ Q change: Within $\pm 20\%$	
	HK1608, HK2125		
	HKQ0603		
AQ105			
MCOIL™ MC series	Appearance: No significant abnormality Inductance change: Within $\pm 10\%$		
Test Methods and Remarks	Conditions for 1 cycle		
	Step	temperature ($^\circ\text{C}$)	time (min.)
	1	Minimum operating temperature $+0/-3$	30 ± 3
	2	Room temperature	$2 \sim 3$
	3	Maximum operating temperature $+3/-0$	30 ± 3
	4	Room temperature	$2 \sim 3$
Number of cycles: 5			
Recovery: 2 to 3 hrs of recovery under the standard condition after the test. (See Note 1)			

(Note 1) When there are questions concerning measurement result; measurement shall be made after 48 ± 2 hrs of recovery under the standard condition.

14. Damp Heat (Steady state)		
Specified Value	BK series	Appearance: No significant abnormality Impedance change: Within $\pm 30\%$
	BKH series	
	BKP series	
	MCF series	Appearance: No significant abnormality Impedance change: Within $\pm 20\%$
	CK series	Appearance: No significant abnormality Inductance change: Within $\pm 20\%$
	CKS series	
	CKP series	Appearance: No significant abnormality Inductance change: Within $\pm 30\%$
	LK series	Appearance: No significant abnormality Inductance change: 1005,1608 \Rightarrow Within $\pm 10\%$ 2125 \Rightarrow Within $\pm 20\%$ Q change: Within $\pm 30\%$
	HK0603, HK1005	Appearance: No significant abnormality Inductance change: Within $\pm 10\%$ Q change: Within $\pm 20\%$
	HK1608, HK2125	
	HKQ0603	
	AQ105	
MCOIL™ MC series	Appearance: No significant abnormality Inductance change: Within $\pm 10\%$	
Test Methods and Remarks	BK, BKP, BKH, LK, CK, CKS, CKP, MCF Series: Temperature : $40 \pm 2^\circ\text{C}$ Humidity : 90 to 95%RH Duration : 500 +24/-0 hrs Recovery : 2 to 3 hrs of recovery under the standard condition after the removal from test chamber. (See Note 1) HK, HKQ, AQ, MCOIL™ MC series: Temperature : $60 \pm 2^\circ\text{C}$ Humidity : 90 to 95%RH Duration : 500 +24/-0 hrs Recovery : 2 to 3 hrs of recovery under the standard condition after the removal from test chamber. (See Note 1)	

(Note 1) When there are questions concerning measurement result; measurement shall be made after 48 ± 2 hrs of recovery under the standard condition.

15. Loading under Damp Heat		
Specified Value	BK series	Appearance: No significant abnormality Impedance change: Within $\pm 30\%$
	BKH series	
	BKP series	
	MCF series	—
	CK series	Appearance: No significant abnormality Inductance change: Within $\pm 20\%$
	CKS series	
	CKP series	Appearance: No significant abnormality Inductance change: Within $\pm 30\%$
	LK series	Appearance: No significant abnormality Inductance change: 1005 \Rightarrow Within $\pm 10\%$ 1608 \Rightarrow 0.047~12.0 μH : Within $\pm 10\%$ 15.0~33.0 μH : Within $\pm 15\%$ 2125 \Rightarrow Within $\pm 20\%$ Q change: Within $\pm 30\%$
	HK0603, HK1005	Appearance: No significant abnormality Inductance change: Within $\pm 10\%$ Q change: Within $\pm 20\%$
	HK1608, HK2125	
	HKQ0603	
	AQ105	
MCOIL™ MC series※	Appearance: No significant abnormality Inductance change: Within $\pm 10\%$	
Test Methods and Remarks	BK, BKP, BKH, LK, CK, CKS, CKP Series: Temperature : $40 \pm 2^\circ\text{C}$ Humidity : 90 to 95%RH Applied current : Rated current Duration : 500 +24/-0 hrs Recovery : 2 to 3 hrs of recovery under the standard condition after the removal from test chamber. (See Note 1) HK, HKQ, AQ, MCOIL™ MC Series: Temperature : $60 \pm 2^\circ\text{C}$ Humidity : 90 to 95%RH Applied current : Rated current ※MC series ; Idc2max Duration : 500 +24/-0 hrs Recovery : 2 to 3 hrs of recovery under the standard condition after the removal from test chamber. (See Note 1)	

Note on standard condition: "standard condition" referred to herein is defined as follows:

5 to 35°C of temperature, 45 to 85% relative humidity, and 86 to 106kPa of air pressure.

When there are questions concerning measurement results:

In order to provide correlation data, the test shall be conducted under condition of $20 \pm 2^\circ\text{C}$ of temperature, 60 to 70% relative humidity, and 86 to 106kPa of air pressure.

Unless otherwise specified, all the tests are conducted under the "standard condition."

(Note 1) Measurement shall be made after 48 ± 2 hrs of recovery under the standard condition.

16. Loading at High Temperature		
Specified Value	BK series	Appearance: No significant abnormality Impedance change: Within $\pm 30\%$
	BKH series	
	BKP series	
	MCF series	Appearance: No significant abnormality Impedance change: Within $\pm 20\%$
	CK series	Appearance: No significant abnormality
	CKS series	Inductance change: Within $\pm 20\%$
	CKP series	Appearance: No significant abnormality Inductance change: Within $\pm 30\%$
	LK series	Appearance: No significant abnormality Inductance change: 1005 \Rightarrow Within $\pm 10\%$ 1608 \Rightarrow 0.047~12.0 μH : Within $\pm 10\%$ 15.0~33.0 μH : Within $\pm 15\%$ 2125 \Rightarrow Within $\pm 20\%$ Q change: Within $\pm 30\%$
	HK0603, HK1005	Appearance: No significant abnormality Inductance change: Within $\pm 10\%$ Q change: Within $\pm 20\%$
	HK1608, HK2125	
	HKQ0603	
	AQ105	
MCOIL™ MC series※	Appearance: No significant abnormality Inductance change: Within $\pm 10\%$	
Test Methods and Remarks	Temperature : Maximum operating temperature Applied current : Rated current ※MC series ; Idc2max Duration : 500 +24/-0 hrs Recovery : 2 to 3 hrs of recovery under the standard condition after the removal from test chamber. (See Note 1)	

Note on standard condition: "standard condition" referred to herein is defined as follows:
5 to 35°C of temperature, 45 to 85% relative humidity, and 86 to 106kPa of air pressure.

When there are questions concerning measurement results:

In order to provide correlation data, the test shall be conducted under condition of 20 \pm 2°C of temperature, 60 to 70% relative humidity, and 86 to 106kPa of air pressure. Unless otherwise specified, all the tests are conducted under the "standard condition."

(Note 1) Measurement shall be made after 48 \pm 2 hrs of recovery under the standard condition.

Precautions on the use of Multilayer chip inductors

Multilayer chip inductors for high frequency, Multilayer chip bead inductors

Multilayer common mode choke coils (MC series F type)

■ PRECAUTIONS

1. Circuit Design

- Precautions**
- ◆ Verification of operating environment, electrical rating and performance
 1. A malfunction in medical equipment, spacecraft, nuclear reactors, etc. may cause serious harm to human life or have severe social ramifications.
As such, any inductors to be used in such equipment may require higher safety and/or reliability considerations and should be clearly differentiated from components used in general purpose applications.
 - ◆ Operating Current (Verification of Rated current)
 1. The operating current including inrush current for inductors must always be lower than their rated values.
 2. Do not apply current in excess of the rated value because the inductance may be reduced due to the magnetic saturation effect.

2. PCB Design

- Precautions**
- ◆ Pattern configurations (Design of Land-patterns)
 1. When inductors are mounted on a PCB, the size of land patterns and the amount of solder used (size of fillet) can directly affect inductor performance.
Therefore, the following items must be carefully considered in the design of solder land patterns:
 - (1) The amount of solder applied can affect the ability of chips to withstand mechanical stresses which may lead to breaking or cracking. Therefore, when designing land-patterns it is necessary to consider the appropriate size and configuration of the solder pads which in turn determines the amount of solder necessary to form the fillets.
 - (2) When more than one part is jointly soldered onto the same land or pad, the pad must be designed so that each component's soldering point is separated by solder-resist.
 - (3) The larger size of land patterns and amount of solder, the smaller Q value after mounting on PCB. It makes higher the Q value to design land patterns smaller than terminal electrode of chips.
 - ◆ Pattern configurations (Inductor layout on panelized [breakaway] PC boards)
 1. After inductors have been mounted on the boards, chips can be subjected to mechanical stresses in subsequent manufacturing processes (PCB cutting, board inspection, mounting of additional parts, assembly into the chassis, wave soldering the reflow soldered boards etc.) For this reason, planning pattern configurations and the position of SMD inductors should be carefully performed to minimize stress.

- Technical considerations**
- ◆ Pattern configurations (Design of Land-patterns)
 1. The following diagrams and tables show some examples of recommended patterns to prevent excessive solder amounts (larger fillets which extend above the component end terminations). Examples of improper pattern designs are also shown.
 - (1) Recommended land dimensions for a typical chip inductor land patterns for PCBs

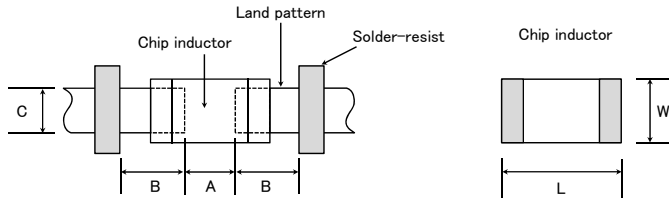

Recommended land dimensions for wave-soldering (Unit: mm)

Type	1608	2012	2125	2016	2520	3216
Size	L	1.6	2.0	2.0	2.5	3.2
	W	0.8	1.25	1.25	1.6	2.0
A	0.8~1.0	1.0~1.4	1.0~1.4	1.0~1.4	1.0~1.4	1.8~2.5
B	0.5~0.8	0.8~1.5	0.8~1.5	0.8~1.5	0.6~1.0	0.8~1.7
C	0.6~0.8	0.9~1.2	0.9~1.2	1.3~1.6	1.6~2.0	1.2~1.6

Recommended land dimensions for reflow-soldering (Unit: mm)

Type	0603	1005	105	1608	2012	2125	2016	2520	3216
Size	L	0.6	1.0	1.0	1.6	2.0	2.0	2.5	3.2
	W	0.3	0.5	0.6	0.8	1.25	1.25	1.6	2.0
A	0.20~0.30	0.45~0.55	0.50~0.55	0.8~1.0	0.8~1.2	0.8~1.2	0.8~1.2	1.0~1.4	1.8~2.5
B	0.20~0.30	0.40~0.50	0.30~0.40	0.6~0.8	0.8~1.2	0.8~1.2	0.8~1.2	0.6~1.0	0.6~1.5
C	0.25~0.40	0.45~0.55	0.60~0.70	0.6~0.8	0.9~1.6	0.9~1.6	1.2~2.0	1.8~2.2	1.2~2.0

▶ This catalog contains the typical specification only due to the limitation of space. When you consider the purchase of our products, please check our specification. For details of each product (characteristics graph, reliability information, precautions for use, and so on), see our Web site (<http://www.ty-top.com/>).

Excess solder can affect the ability of chips to withstand mechanical stresses. Therefore, please take proper precautions when designing land-patterns.

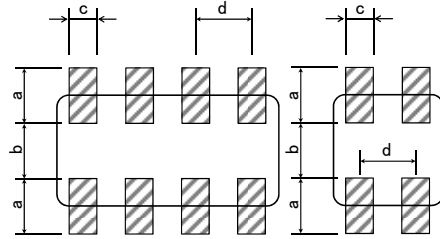

Recommended land dimension for Reflow-soldering

Type	3216	2010	1210	0806	0605	
Size	L	3.2	2.0	1.25	0.85	0.65
	W	1.6	1.0	1.0	0.65	0.50
a	0.7~0.9	0.5~0.6	0.45~0.55	0.25~0.35	0.27~0.33	
b	0.8~1.0	0.5~0.6	0.7~0.8	0.25~0.35	0.17~0.23	
c	0.4~0.5	0.2~0.3	0.25~0.35	0.25~0.35	0.20~0.26	
d	0.8	0.5	0.55	0.5	0.4	

(Unit: mm)

(2) Examples of good and bad solder application

Item	Not recommended	Recommended
Mixed mounting of SMD and leaded components		
Component placement close to the chassis		
Hand-soldering of leaded components near mounted components		
Horizontal component placement		

◆ Pattern configurations (Inductor layout on panelized [breakaway] PC boards)

1-1. The following are examples of good and bad inductor layout; SMD inductors should be located to minimize any possible mechanical stresses from board warp or deflection.

Item	Not recommended	Recommended
Deflection of the board		 Position the component at a right angle to the direction of the mechanical stresses that are anticipated.

1-2. To layout the inductors for the breakaway PC board, it should be noted that the amount of mechanical stresses given will vary depending on inductor layout.

An example below should be counted for better design.

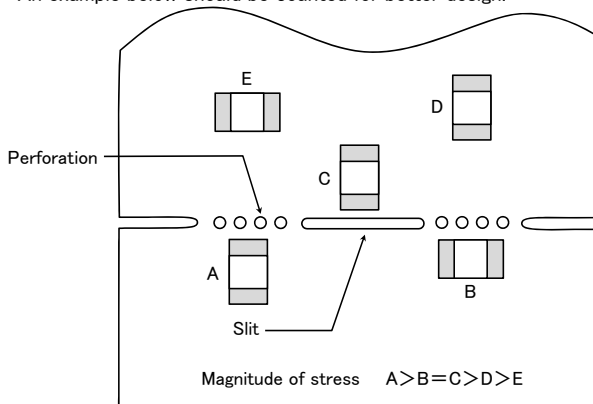

1-3. When breaking PC boards along their perforations, the amount of mechanical stress on the inductors can vary according to the method used. The following methods are listed in order from least stressful to most stressful: push-back, slit, V-grooving, and perforation. Thus, any ideal SMD inductor layout must also consider the PCB splitting procedure.

3. Considerations for automatic placement

Precautions

- ◆ Adjustment of mounting machine
 1. Excessive impact load should not be imposed on the inductors when mounting onto the PC boards.
 2. The maintenance and inspection of the mounter should be conducted periodically.
- ◆ Selection of Adhesives
 1. Mounting inductors with adhesives in preliminary assembly, before the soldering stage, may lead to degraded inductor characteristics unless the following factors are appropriately checked; the size of land patterns, type of adhesive, amount applied, hardening temperature and hardening period. Therefore, it is imperative to consult the manufacturer of the adhesives on proper usage and amounts of adhesive to use.

Technical considerations

- ◆ Adjustment of mounting machine
 1. If the lower limit of the pick-up nozzle is low, too much force may be imposed on the inductors, causing damage. To avoid this, the following points should be considered before lowering the pick-up nozzle:
 - (1) The lower limit of the pick-up nozzle should be adjusted to the surface level of the PC board after correcting for deflection of the board.
 - (2) The pick-up pressure should be adjusted between 1 and 3N static loads.
 - (3) To reduce the amount of deflection of the board caused by impact of the pick-up nozzle, supporting pins or back-up pins should be used under the PC board. The following diagrams show some typical examples of good pick-up nozzle placement:

Item	Improper method	Proper method
Single-sided mounting		
Double-sided mounting		

2. As the alignment pin wears out, adjustment of the nozzle height can cause chipping or cracking of the inductors because of mechanical impact on the inductors. To avoid this, the monitoring of the width between the alignment pin in the stopped position, and maintenance, inspection and replacement of the pin should be conducted periodically.

- ◆ Selection of Adhesives
 1. Some adhesives may cause reduced insulation resistance. The difference between the shrinkage percentage of the adhesive and that of the inductors may result in stresses on the inductors and lead to cracking. Moreover, too little or too much adhesive applied to the board may adversely affect component placement, so the following precautions should be noted in the application of adhesives.
 - (1) Required adhesive characteristics
 - a. The adhesive should be strong enough to hold parts on the board during the mounting & solder process.
 - b. The adhesive should have sufficient strength at high temperatures.
 - c. The adhesive should have good coating and thickness consistency.
 - d. The adhesive should be used during its prescribed shelf life.
 - e. The adhesive should harden rapidly.
 - f. The adhesive must not be contaminated.
 - g. The adhesive should have excellent insulation characteristics.
 - h. The adhesive should not be toxic and have no emission of toxic gasses.
 - (2) When using adhesives to mount inductors on a PCB, inappropriate amounts of adhesive on the board may adversely affect component placement. Too little adhesive may cause the inductors to fall off the board during the solder process. Too much adhesive may cause defective soldering due excessive flow of adhesive on to the land or solder pad.

[Recommended conditions]

Figure	0805 case sizes as examples
a	0.3mm min
b	100~120 μm
c	Area with no adhesive



4. Soldering

Precautions

- ◆ Selection of Flux
 1. Since flux may have a significant effect on the performance of inductors, it is necessary to verify the following conditions prior to use;
 - (1) Flux used should be with less than or equal to 0.1 wt% (Chlorine conversion method) of halogenated content. Flux having a strong acidity content should not be applied.
 - (2) When soldering inductors on the board, the amount of flux applied should be controlled at the optimum level.
 - (3) When using water-soluble flux, special care should be taken to properly clean the boards.
- ◆ Soldering
 1. Temperature, time, amount of solder, etc. are specified in accordance with the following recommended conditions, and please contact us about peak temperature when you use lead-free paste.

◆ Selection of Flux

- 1-1. When too much halogenated substance (Chlorine, etc.) content is used to activate the flux, or highly acidic flux is used, an excessive amount of residue after soldering may lead to corrosion of the terminal electrodes or degradation of insulation resistance on the surface of the Inductor.
- 1-2. Flux is used to increase solderability in flow soldering, but if too much is applied, a large amount of flux gas may be emitted and may detrimentally affect solderability. To minimize the amount of flux applied, it is recommended to use a flux-bubbling system.
- 1-3. Since the residue of water-soluble flux is easily dissolved by water content in the air, the residue on the surface of Inductor in high humidity conditions may cause a degradation of insulation resistance and therefore affect the reliability of the components. The cleaning methods and the capability of the machines used should also be considered carefully when selecting water-soluble flux.

◆ Soldering

1-1. Preheating when soldering

Heating: Chip inductor components should be preheated to within 100 to 130°C of the soldering. Cooling: The temperature difference between the components and cleaning process should not be greater than 100°C.

Chip inductors are susceptible to thermal shock when exposed to rapid or concentrated heating or rapid cooling. Therefore, the soldering process must be conducted with a great care so as to prevent malfunction of the components due to excessive thermal shock.

[Reflow soldering]

【Recommended conditions for eutectic soldering】

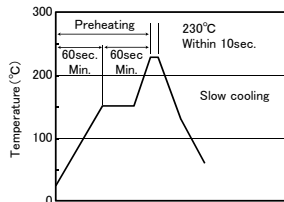

【Recommended condition for Pb-free soldering】

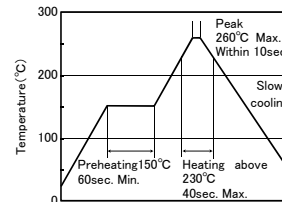

- ※Ceramic chip components should be preheated to within 100 to 130°C of the soldering.
- ※Assured to be reflow soldering for 2 times.
- ※MC series; Peak 230°C (eutectic soldering), 260°C (Pb-free soldering) max within 5sec.

Caution

1. The ideal condition is to have solder mass (fillet) controlled to 1/2 to 1/3 of the thickness of the inductor, as shown below:

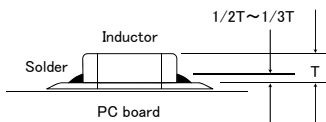

2. Because excessive dwell times can detrimentally affect solderability, soldering duration should be kept as close to recommended times as possible.

[Wave soldering]

【Recommended conditions for eutectic soldering】

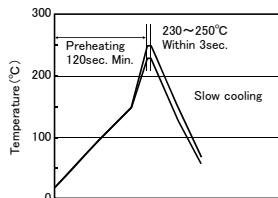

【Recommended condition for Pb-free soldering】

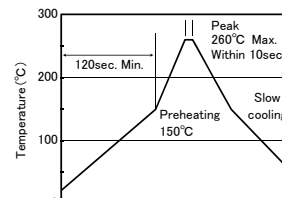

- ※Ceramic chip components should be preheated to within 100 to 130°C of the soldering.
- ※Assured to be wave soldering for 1 time.
- ※Except for reflow soldering type.

Caution

1. Make sure the inductors are preheated sufficiently.
2. The temperature difference between the inductor and melted solder should not be greater than 100 to 130°C.
3. Cooling after soldering should be as gradual as possible.
4. Wave soldering must not be applied to the inductors designated as for reflow soldering only.

[Hand soldering]

【Recommended conditions for eutectic soldering】

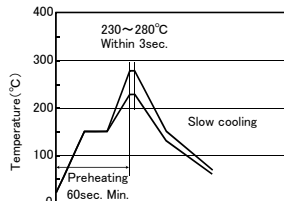

【Recommended condition for Pb-free soldering】

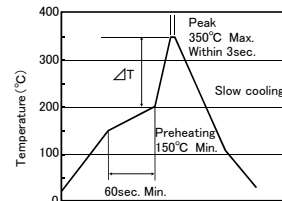

- (※) $\Delta T \leq 190^\circ\text{C}$ (3216 Type max), $\Delta T \leq 130^\circ\text{C}$ (3225 Type min)
- ※It is recommended to use 20W soldering iron and the tip is 1ϕ or less.
- ※The soldering iron should not directly touch the components.
- ※Assured to be soldering iron for 1 time.
- Note: The above profiles are the maximum allowable soldering condition, therefore these profiles are not always recommended.

Technical considerations

	<p>Caution</p> <ol style="list-style-type: none"> 1. Use a 20W soldering iron with a maximum tip diameter of 1.0 mm. 2. The soldering iron should not directly touch the inductor. 						
5. Cleaning							
Precautions	<p>◆Cleaning conditions</p> <ol style="list-style-type: none"> 1. When cleaning the PC board after the Inductors are all mounted, select the appropriate cleaning solution according to the type of flux used and purpose of the cleaning (e.g. to remove soldering flux or other materials from the production process.) 2. Cleaning conditions should be determined after verifying, through a test run, that the cleaning process does not affect the inductor's characteristics. 						
Technical considerations	<p>◆Cleaning conditions</p> <ol style="list-style-type: none"> 1. The use of inappropriate solutions can cause foreign substances such as flux residue to adhere to the inductor, resulting in a degradation of the inductor's electrical properties (especially insulation resistance). 2. Inappropriate cleaning conditions (insufficient or excessive cleaning) may detrimentally affect the performance of the inductors. <ol style="list-style-type: none"> (1) Excessive cleaning <ol style="list-style-type: none"> a. In the case of ultrasonic cleaning, too much power output can cause excessive vibration of the PC board which may lead to the cracking of the inductor or the soldered portion, or decrease the terminal electrodes' strength. Thus the following conditions should be carefully checked; <table border="0" style="margin-left: 40px;"> <tr> <td style="padding-right: 20px;">Ultrasonic output</td> <td>Below 20W/l</td> </tr> <tr> <td>Ultrasonic frequency</td> <td>Below 40kHz</td> </tr> <tr> <td>Ultrasonic washing period</td> <td>5 min. or less</td> </tr> </table> 	Ultrasonic output	Below 20W/l	Ultrasonic frequency	Below 40kHz	Ultrasonic washing period	5 min. or less
Ultrasonic output	Below 20W/l						
Ultrasonic frequency	Below 40kHz						
Ultrasonic washing period	5 min. or less						
6. Post cleaning processes							
Precautions	<p>◆Application of resin coatings, moldings, etc. to the PCB and components.</p> <ol style="list-style-type: none"> 1. With some type of resins a decomposition gas or chemical reaction vapor may remain inside the resin during the hardening period or while left under normal storage conditions resulting in the deterioration of the inductor's performance. 2. When a resin's hardening temperature is higher than the inductor's operating temperature, the stresses generated by the excess heat may lead to inductor damage or destruction. 3. Stress caused by a resin's temperature generated expansion and contraction may damage inductors. <p>The use of such resins, molding materials etc. is not recommended.</p>						
7. Handling							
Precautions	<p>◆Breakaway PC boards (splitting along perforations)</p> <ol style="list-style-type: none"> 1. When splitting the PC board after mounting inductors and other components, care is required so as not to give any stresses of deflection or twisting to the board. 2. Board separation should not be done manually, but by using the appropriate devices. <p>◆General handling precautions</p> <ol style="list-style-type: none"> 1. Always wear static control bands to protect against ESD. 2. Keep the inductors away from all magnets and magnetic objects. 3. Use non-magnetic tweezers when handling inductors. 4. Any devices used with the inductors (soldering irons, measuring instruments) should be properly grounded. 5. Keep bare hands and metal products (i.e., metal desk) away from chip electrodes or conductive areas that lead to chip electrodes. 6. Keep inductors away from items that generate magnetic fields such as speakers or coils. <p>◆Mechanical considerations</p> <ol style="list-style-type: none"> 1. Be careful not to subject the inductors to excessive mechanical shocks. <ol style="list-style-type: none"> (1) If inductors are dropped on the floor or a hard surface they should not be used. (2) When handling the mounted boards, be careful that the mounted components do not come in contact with or bump against other boards or components. 						
8. Storage conditions							
Precautions	<p>◆Storage</p> <ol style="list-style-type: none"> 1. To maintain the solderability of terminal electrodes and to keep the packaging material in good condition, care must be taken to control temperature and humidity in the storage area. Humidity should especially be kept as low as possible. <ul style="list-style-type: none"> •Recommended conditions <table border="0" style="margin-left: 20px;"> <tr> <td style="padding-right: 20px;">Ambient temperature: Below 30°C</td> <td>Humidity: Below 70% RH</td> </tr> </table> <p>The ambient temperature must be kept below 40°C. Even under ideal storage conditions, solderability of inductor is deteriorated as time passes, so inductors should be used within 6 months from the time of delivery.</p> <ul style="list-style-type: none"> •Inductor should be kept where no chlorine or sulfur exists in the air. 	Ambient temperature: Below 30°C	Humidity: Below 70% RH				
Ambient temperature: Below 30°C	Humidity: Below 70% RH						
Technical considerations	<p>◆Storage</p> <ol style="list-style-type: none"> 1. If the parts are stocked in a high temperature and humidity environment, problems such as reduced solderability caused by oxidation of terminal electrodes and deterioration of taping/packaging materials may take place. For this reason, components should be used within 6 months from the time of delivery. If exceeding the above period, please check solderability before using the inductors. 						