

Notice for TAIYO YUDEN Products

[For High Quality and/or Reliability Equipment
(Automotive Electronic Equipment / Industrial Equipment)]

Please read this notice before using the TAIYO YUDEN products.

REMINDERS

- Product information in this catalog is as of October 2018. All of the contents specified herein are subject to change without notice due to technical improvements, etc. Therefore, please check for the latest information carefully before practical application or use of our products.

Please note that TAIYO YUDEN shall not be in any way responsible for any damages and defects in products or equipment incorporating our products, which are caused under the conditions other than those specified in this catalog or individual product specification sheets.

- Please contact TAIYO YUDEN for further details of product specifications as the individual product specification sheets are available.
- Please conduct validation and verification of our products in actual condition of mounting and operating environment before using our products.
- The products listed in this catalog are intended for use in general electronic equipment (e.g., AV equipment, OA equipment, home electric appliances, office equipment, information and communication equipment), medical equipment classified as Class I or II by IMDRF, industrial equipment, and automotive interior applications, etc. Please be sure to contact TAIYO YUDEN for further information before using the products for any equipment which may directly cause loss of human life or bodily injury (e.g., transportation equipment including, without limitation, automotive powertrain control system, train control system, and ship control system, traffic signal equipment, medical equipment classified as Class III by IMDRF).

Please do not incorporate our products into any equipment requiring high levels of safety and/or reliability (e.g., aerospace equipment, aviation equipment*, medical equipment classified as Class IV by IMDRF, nuclear control equipment, undersea equipment, military equipment).

*Note: There is a possibility that our products can be used only for aviation equipment that does not directly affect the safe operation of aircraft (e.g., in-flight entertainment, cabin light, electric seat, cooking equipment) if such use meets requirements specified separately by TAIYO YUDEN. Please be sure to contact TAIYO YUDEN for further information before using our products for such aviation equipment.

When our products are used even for high safety and/or reliability-required devices or circuits of general electronic equipment, it is strongly recommended to perform a thorough safety evaluation prior to use of our products and to install a protection circuit as necessary.

Please note that unless you obtain prior written consent of TAIYO YUDEN, TAIYO YUDEN shall not be in any way responsible for any damages incurred by you or third parties arising from use of the products listed in this catalog for any equipment requiring inquiry to TAIYO YUDEN or prohibited for use by TAIYO YUDEN as described above.

- Information contained in this catalog is intended to convey examples of typical performances and/or applications of our products and is not intended to make any warranty with respect to the intellectual property rights or any other related rights of TAIYO YUDEN or any third parties nor grant any license under such rights.
- Please note that the scope of warranty for our products is limited to the delivered our products themselves and TAIYO YUDEN shall not be in any way responsible for any damages resulting from a fault or defect in our products. Notwithstanding the foregoing, if there is a written agreement (e.g., supply and purchase agreement, quality assurance agreement) signed by TAIYO YUDEN and your company, TAIYO YUDEN will warrant our products in accordance with such agreement.
- The contents of this catalog are applicable to our products which are purchased from our sales offices or authorized distributors (hereinafter "TAIYO YUDEN's official sales channel"). Please note that the contents of this catalog are not applicable to our products purchased from any seller other than TAIYO YUDEN's official sales channel.

■ Caution for Export

Some of our products listed in this catalog may require specific procedures for export according to "U.S. Export Administration Regulations", "Foreign Exchange and Foreign Trade Control Law" of Japan, and other applicable regulations. Should you have any questions on this matter, please contact our sales staff.

Automotive Application Guide

We classify automotive electronic equipment into the following four application categories and set usable application categories for each of our products. When using our products for automotive electronic equipment, please be sure to check such application categories and use our products accordingly. Should you have any questions on this matter, please contact us.

| Category | Automotive Electronic Equipment (Typical Example) |
|----------------|---|
| POWERTRAIN | <ul style="list-style-type: none"> • Engine ECU (Electronically Controlled Fuel Injector) • Cruise Control Unit • 4WS (4 Wheel Steering) • Automatic Transmission • Power Steering • HEV/PHV/EV Core Control (Battery, Inverter, DC-DC) • Automotive Locator (Car location information providing device), etc. |
| SAFETY | <ul style="list-style-type: none"> • ABS (Anti-Lock Brake System) • ESC (Electronic Stability Control) • Airbag • ADAS (Equipment that directly controls running, turning and stopping), etc. |
| BODY & CHASSIS | <ul style="list-style-type: none"> • Wiper • Automatic Door • Power Window • Keyless Entry System • Electric Door Mirror • Interior Lighting • LED Headlight • TPMS (Tire Pressure Monitoring System) • Anti-Theft Device (Immobilizer), etc. |
| INFOTAINMENT | <ul style="list-style-type: none"> • Car Infotainment System • ITS/Telematics System • Instrument Cluster • ADAS (Sensor, Equipment that is not interlocked with safety equipment or powertrain), etc. |

SMD POWER INDUCTORS(NR SERIES M TYPE)



REFLOW
AEC-Q200

AEC-Q200 Grade 2 (we conduct the evaluation at the test condition of Grade 2.)
*Operating environment Temp:-40~105°C

■ PART NUMBER

*Operating Temp. : -40~125°C (Including self-generated heat)

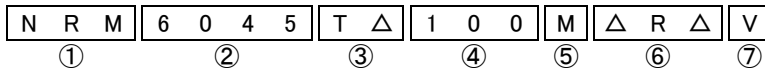

△=Blank space

①Series name

| Code | Series name |
|------|-----------------------------|
| NRM | Coating resin specification |

②Dimensions (L × W × H)

| Code | Dimensions(L × W × H) [mm] |
|------|----------------------------|
| 6045 | 6.0 × 6.0 × 4.5 |

③Packaging

| Code | Packaging |
|------|-----------|
| T△ | Taping |

④Nominal inductance

| Code (example) | Nominal inductance[μH] |
|----------------|------------------------|
| 2R2 | 2.2 |
| 100 | 10 |
| 102 | 1000 |

※R=Decimal point

⑤Inductance tolerance

| Code | Inductance tolerance |
|------|----------------------|
| M | ±20% |
| N | ±30% |

⑥Special code

| Code | Special code |
|------|--------------|
| △R△ | Standard |

⑦Internal code

| Code | Internal code |
|------|-------------------------|
| V | Inductor for Automotive |

■ STANDARD EXTERNAL DIMENSIONS / STANDARD QUANTITY

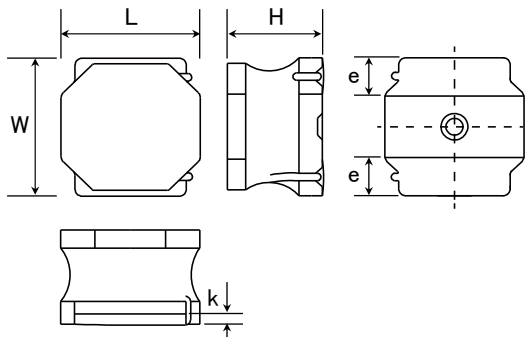

Recommended Lead Patterns

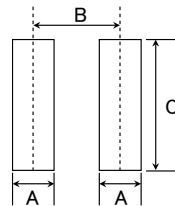

| Type | A | B | C |
|---------|-----|-----|-----|
| NRM6045 | 2.4 | 5.0 | 4.8 |

Unit: mm

| Type | L | W | H | e | k(ref) | Standard quantity [pcs] Taping |
|---------|--------------------------|--------------------------|------------------------|---------------------------|------------------------|--------------------------------|
| NRM6045 | 6.0±0.2 (0.236±0.008) | 6.0±0.2 (0.236±0.008) | 4.5 max (0.177 max) | 1.65±0.3 (0.053±0.012) | 0.3 min (0.012 min) | 1500 |

Unit: mm(inch)

► This catalog contains the typical specification only due to the limitation of space. When you consider the purchase of our products, please check our product specification sheets. For details of each product (characteristics graph, reliability information, precautions for use, and so on), see our website (<http://www.ty-top.com/>).

■ PART NUMBER

• All the SMD Power Inductors of the catalog lineup are RoHS compliant.

Note)

- The exchange of individual specifications is necessary depending on the application and circuit condition. Please contact Taiyo Yuden sales channels.
- *1: Automotive (AEC-Q200 Qualified) products for BODY & CHASSIS, and INFOTAINMENT. Please check "Automotive Application Guide" for further details before using the products.
 < AEC-Q200 : AEC-Q200 qualified >
 All the SMD Power Inductors of *1 marks are tested based on the test conditions and methods defined in AEC-Q200 by family item.
 Please consult with TAIYO YUDEN's official sales channel for the details of the product specification and AEC-Q200 test results, etc.,
 and please review and approve TAIYO YUDEN's product specification before ordering.
- *2: Industrial products and Medical products

● NRM6045

| Parts number | Nominal inductance [μH] | Inductance tolerance | DC Resistance [mΩ] Max (Typ) | Rated current ※) [A] | | | Measuring frequency [MHz] | Note |
|-------------------|----------------------------|----------------------|------------------------------------|---|--|--|------------------------------|--------|
| | | | | Saturation current Idc1 Max (Typ) | Temperature rise current① Idc2 Max (Typ) | Temperature rise current② Idc2 Max (Typ) | | |
| NRM6045T 1R0N R V | 1 | ±30% | 13 (10) | 14.00 (14.50) | 4.00 (6.00) | 6.20 (7.00) | 0.1 | *1, *2 |
| NRM6045T 2R2N R V | 2.2 | ±30% | 28 (23) | 8.50 (9.50) | 3.00 (4.00) | 4.40 (5.10) | 0.1 | *1, *2 |
| NRM6045T 4R7M R V | 4.7 | ±20% | 42 (35) | 6.10 (6.80) | 2.20 (3.00) | 3.60 (3.90) | 0.1 | *1, *2 |
| NRM6045T 100M R V | 10 | ±20% | 60 (50) | 3.40 (3.90) | 1.80 (2.40) | 2.60 (3.00) | 0.1 | *1, *2 |
| NRM6045T 220M R V | 22 | ±20% | 145 (120) | 1.80 (2.10) | 1.20 (1.60) | 1.80 (1.95) | 0.1 | *1, *2 |
| NRM6045T 470M R V | 47 | ±20% | 370 (280) | 1.40 (1.55) | 0.70 (0.90) | 1.20 (1.30) | 0.1 | *1, *2 |
| NRM6045T 101M R V | 100 | ±20% | 600 (500) | 0.95 (1.05) | 0.55 (0.70) | 0.85 (0.95) | 0.1 | *1, *2 |
| NRM6045T 221M R V | 220 | ±20% | 1320 (1100) | 0.65 (0.70) | 0.35 (0.50) | 0.57 (0.65) | 0.1 | *1, *2 |
| NRM6045T 471M R V | 470 | ±20% | 2760 (2300) | 0.45 (0.50) | 0.22 (0.30) | 0.38 (0.45) | 0.1 | *1, *2 |
| NRM6045T 102M R V | 1000 | ±20% | 5900 (4900) | 0.31 (0.35) | 0.15 (0.20) | 0.26 (0.30) | 0.1 | *1, *2 |

- ※) The saturation current value (Idc1) is the DC current value having inductance decrease down to 30%. (at 20°C)
- ※) The temperature rise current value (Idc2)① is the DC current value having temperature increase up to 20°C. (at 20°C)
- ※) The temperature rise current value (Idc2)② is the DC current value having temperature increase up to 40°C. (at 20°C)
- ※) The temperature rise current value (Idc2)② is a reference value.
- ※) The rated current is the DC current value that satisfies both of current value saturation current value and temperature rise current value.

■ Derating of Rated Current

● NR series M type
 Derating of current is necessary for NR series M type depending on ambient temperature.
 Please refer to the chart shown below for appropriate derating of current.

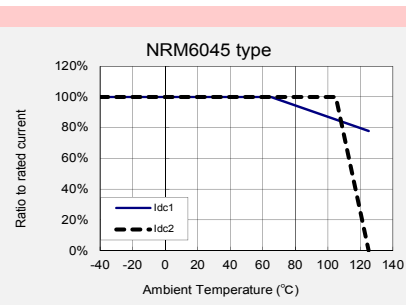

▶ This catalog contains the typical specification only due to the limitation of space. When you consider the purchase of our products, please check our product specification sheets. For details of each product (characteristics graph, reliability information, precautions for use, and so on), see our website (<http://www.ty-top.com/>).

SMD POWER INDUCTORS (NR SERIES/NR SERIES H TYPE/M TYPE/S TYPE/V TYPE)

PACKAGING

① Minimum Quantity

| Type | Standard Quantity [pcs] |
|---------|-------------------------|
| | Tape & Reel |
| NRV2010 | 2500 |
| NRS2012 | 2500 |
| NRV2012 | 2500 |
| NRH2410 | 2500 |
| NRH2412 | 2500 |
| NR 3010 | 2000 |
| NRH3010 | 2000 |
| NR 3012 | 2000 |
| NRH3012 | 2000 |
| NRV3012 | 2000 |
| NR 3015 | 2000 |
| NRS3015 | 2000 |
| NR 4010 | 5000 |
| NRS4010 | 5000 |
| NR 4012 | 4500 |
| NRS4012 | 4500 |
| NR 4018 | 3500 |
| NRS4018 | 3500 |

| Type | Standard Quantity [pcs] |
|---------|-------------------------|
| | Tape & Reel |
| NRS5010 | 1000 |
| NRS5012 | 1000 |
| NRS5014 | 1000 |
| NRS5020 | 800 |
| NRS5024 | 2500 |
| NRS5030 | 500 |
| NR 5040 | 1500 |
| NRS5040 | 1500 |
| NRS6010 | 1000 |
| NR 6012 | 1000 |
| NRS6012 | 1000 |
| NRS6014 | 1000 |
| NR 6020 | 2500 |
| NRS6020 | 2500 |
| NR 6028 | 2000 |
| NRS6028 | 2000 |
| NR 6045 | 1500 |
| NRM6045 | 1500 |
| NRS6045 | 1500 |
| NRS8030 | 1000 |
| NR 8040 | 1000 |
| NRS8040 | 1000 |

② Tape Material

● Embossed Tape

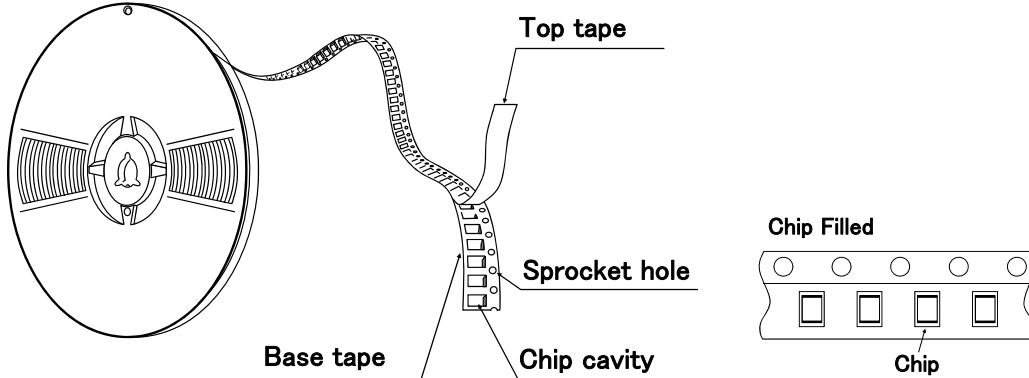

③ Taping dimensions

● Embossed tape 8mm wide (0.315 inches wide)

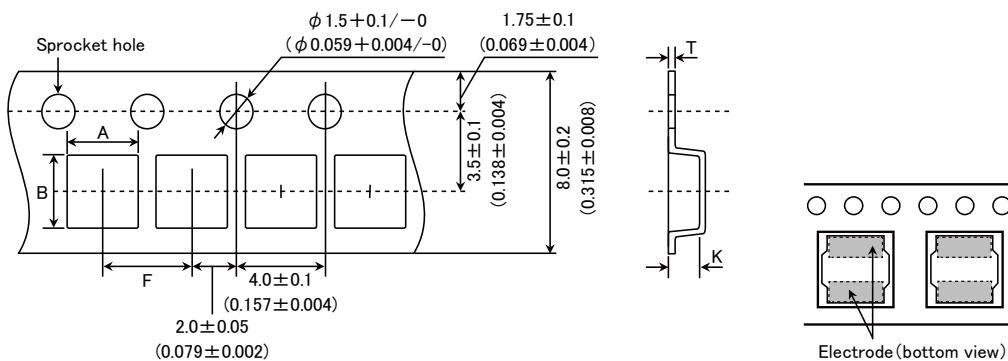

▶ This catalog contains the typical specification only due to the limitation of space. When you consider the purchase of our products, please check our specification. For details of each product (characteristics graph, reliability information, precautions for use, and so on), see our Web site (<http://www.ty-top.com/>).

| Type | Chip cavity | | Insertion pitch | Tape thickness | |
|-------------------------------|--------------------------|--------------------------|--------------------------|----------------------------|--------------------------|
| | A | B | | T | K |
| NRV2010 | 2.2±0.1 (0.102±0.004) | 2.2±0.1 (0.102±0.004) | 4.0±0.1 (0.157±0.004) | 0.25±0.05 (0.009±0.002) | 1.3±0.1 (0.051±0.004) |
| NRS2012 NRV2012 | | | | | |
| NRH2410 | 2.6±0.1 (0.087±0.004) | 2.6±0.1 (0.102±0.004) | | 0.25±0.05 (0.009±0.002) | 1.3±0.1 (0.051±0.004) |
| NRH2412 | | | | | |
| NR 3010 NRH3010 | 3.2±0.1 (0.126±0.004) | 3.2±0.1 (0.126±0.004) | | 0.3±0.05 (0.012±0.002) | 1.4±0.1 (0.055±0.004) |
| NR 3012 NRH3012 NRV3012 | | | | | 1.6±0.1 (0.063±0.004) |
| NR 3015 NRS3015 | | | | | 1.9±0.1 (0.075±0.004) |

Unit : mm (inch)

● Embossed tape 12mm wide (0.47 inches wide)

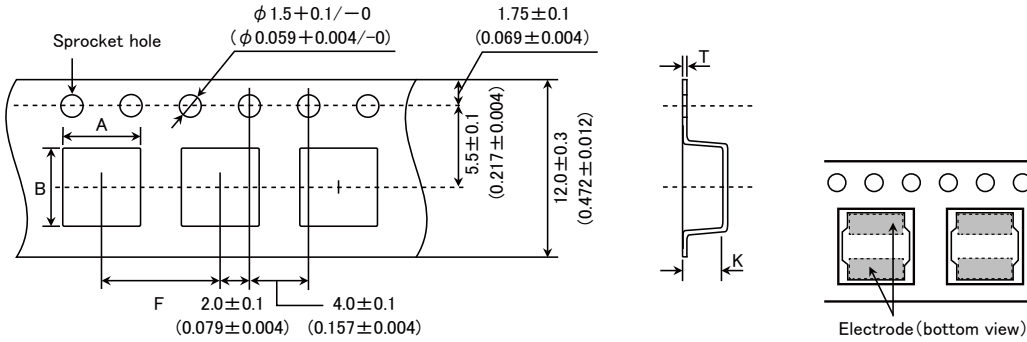

| Type | Chip cavity | | Insertion pitch | Tape thickness | |
|-------------------------------|---------------------------|---------------------------|--------------------------|--------------------------|--------------------------|
| | A | B | | T | K |
| NR 4010 NRS4010 | 4.3±0.1 (0.169±0.004) | 4.3±0.1 (0.169±0.004) | 8.0±0.1 (0.315±0.004) | 0.3±0.1 (0.012±0.004) | 1.4±0.1 (0.055±0.004) |
| NR 4012 NRS4012 | | | | | 1.6±0.1 (0.063±0.004) |
| NR 4018 NRS4018 | 2.1±0.1 (0.083±0.004) | | | | |
| NRS5010 | 5.25±0.1 (0.207±0.004) | 5.25±0.1 (0.207±0.004) | | 0.3±0.1 (0.012±0.004) | 1.4±0.1 (0.055±0.004) |
| NRS5012 | | | | | 1.4±0.1 (0.055±0.004) |
| NRS5014 | | | | | 1.6±0.1 (0.063±0.004) |
| NRS5020 | | | | | 2.3±0.1 (0.091±0.004) |
| NRS5024 | | | | | 2.7±0.1 (0.106±0.004) |
| NRS5030 | 5.15±0.1 (0.203±0.004) | 5.15±0.1 (0.203±0.004) | | 0.3±0.1 (0.012±0.004) | 3.2±0.1 (0.126±0.004) |
| NR 5040 NRS5040 | 5.15±0.1 (0.203±0.004) | 5.15±0.1 (0.203±0.004) | | | 4.2±0.1 (0.165±0.004) |
| NRS6010 | 6.3±0.1 (0.248±0.004) | 6.3±0.1 (0.248±0.004) | 0.4±0.1 (0.016±0.004) | 1.4±0.1 (0.055±0.004) | |
| NR 6012 NRS6012 | | | | 1.6±0.1 (0.063±0.004) | |
| NRS6014 | | | | 1.6±0.1 (0.063±0.004) | |
| NR 6020 NRS6020 | | | | 2.3±0.1 (0.090±0.004) | |
| NR 6028 NRS6028 | | | | 3.1±0.1 (0.122±0.004) | |
| NR 6045 NRM6045 NRS6045 | | | | 4.7±0.1 (0.185±0.004) | |

Unit : mm (inch)

▶ This catalog contains the typical specification only due to the limitation of space. When you consider the purchase of our products, please check our specification. For details of each product (characteristics graph, reliability information, precautions for use, and so on), see our Web site (<http://www.ty-top.com/>).

● Embossed tape 16mm wide (0.63 inches wide)

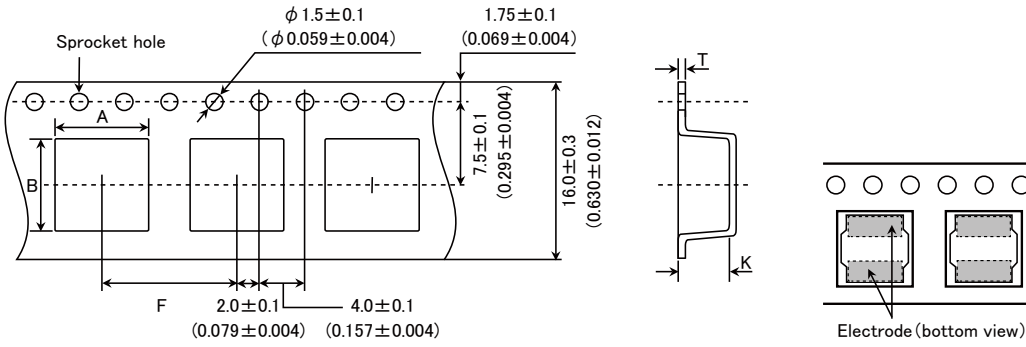

| Type | Chip cavity | | Insertion pitch F | Tape thickness | |
|--------------------|----------------------------------|----------------------------------|-----------------------------------|----------------------------------|----------------------------------|
| | A | B | | T | K |
| NRS8030 | 8.3 ± 0.1 (0.327 ± 0.004) | 8.3 ± 0.1 (0.327 ± 0.004) | 12.0 ± 0.1 (0.472 ± 0.004) | 0.5 ± 0.1 (0.020 ± 0.004) | 3.4 ± 0.1 (0.134 ± 0.004) |
| NR 8040 NRS8040 | | | | | 4.5 ± 0.1 (0.177 ± 0.004) |

Unit: mm (inch)

④ Leader and Blank portion

● NR, NRH, NRS, NRV



⑤ Reel size



| Type | Reel size (Reference values) | | |
|---------|----------------------------------|-------------------------------|-----------------------------------|
| | ϕD | ϕd | W |
| NRV2010 | 180 ± 0.5 (7.087 ± 0.019) | 60 ± 1.0 (2.36 ± 0.04) | 10.0 ± 1.5 (0.394 ± 0.059) |
| NRS2012 | | | |
| NRV2012 | | | |
| NRH2410 | | | |
| NRH2412 | | | |
| NR 3010 | | | |
| NRH3010 | | | |
| NR 3012 | | | |
| NRH3012 | | | |
| NRV3012 | | | |
| NR 3015 | 180 ± 0.5 (7.087 ± 0.019) | 60 ± 1.0 (2.36 ± 0.04) | 10.0 ± 1.5 (0.394 ± 0.059) |
| NRS3015 | | | |

▶ This catalog contains the typical specification only due to the limitation of space. When you consider the purchase of our products, please check our specification. For details of each product (characteristics graph, reliability information, precautions for use, and so on), see our Web site (<http://www.ty-top.com/>).

| | | | |
|---------|--------------------------|-----------------------|---------------------------|
| NRS5010 | 180±3.0 (7.087±0.118) | 60±2.0 (2.36±0.08) | 14.0±1.5 (0.551±0.059) |
| NRS5012 | | | |
| NRS5014 | | | |
| NRS5020 | | | |
| NRS5030 | | | |
| NRS6010 | | | |
| NR 6012 | | | |
| NRS6012 | | | |
| NRS6014 | | | |

Unit: mm (inch)



| Type | Reel size (Reference values) | | | |
|---------|------------------------------|--------------------------|----------------|--------------------------|
| | φD | φd | t (max.) | W |
| NR 4010 | 330±3.0 (12.99±0.118) | 80±2.0 (3.15±0.078) | 18.5 (0.72) | 13.5±1.0 (0.531±0.04) |
| NRS4010 | | | | |
| NR 4012 | | | | |
| NRS4012 | | | | |
| NR 4018 | | | | |
| NRS4018 | | | | |
| NRS5024 | | | | |
| NR 5040 | | | | |
| NRS5040 | | | | |
| NR 6020 | | | | |
| NRS6020 | | | | |
| NR 6028 | | | | |
| NRS6028 | | | | |
| NR 6045 | | | | |
| NRM6045 | | | | |
| NRS6045 | | | | |
| NRS8030 | 22.5 (0.89) | 17.5±1.0 (0.689±0.04) | | |
| NR 8040 | | | | |
| NRS8040 | | | | |

Unit: mm (inch)

⑥ Top Tape Strength

The top tape requires a peel-off force of 0.1 to 1.3N in the direction of the arrow as illustrated below.



SMD POWER INDUCTORS (NR□ SERIES)

RELIABILITY DATA

| 1. Operating Temperature Range | | | | | | | | | | | | | | |
|--------------------------------|---|--|------------------|---|----|---|-------------------------------|---|---------------------------|---|-------------------------------|---|----|--|
| Specified Value | NRV20/30Type, NRH24/30Type NRS20/30/40/50/60/80Type | -40~+125°C (Including self-generated heat) | | | | | | | | | | | | |
| Test Methods and Remarks | Including self-generated heat | | | | | | | | | | | | | |
| 2. Storage Temperature Range | | | | | | | | | | | | | | |
| Specified Value | NRV20/30Type, NRH24/30Type NRS20/30/40/50/60/80Type | -40~+85°C | | | | | | | | | | | | |
| Test Methods and Remarks | -5 to 40°C for the product with taping. | | | | | | | | | | | | | |
| 3. Rated current | | | | | | | | | | | | | | |
| Specified Value | NRV20/30Type, NRH24/30Type NRS20/30/40/50/60/80Type | Within the specified tolerance | | | | | | | | | | | | |
| 4. Inductance | | | | | | | | | | | | | | |
| Specified Value | NRV20/30Type, NRH24/30Type NRS20/30/40/50/60/80Type | Within the specified tolerance | | | | | | | | | | | | |
| Test Methods and Remarks | Measuring equipment : LCR Meter (HP 4285A or equivalent) Measuring frequency : 100kHz, 1V | | | | | | | | | | | | | |
| 5. DC Resistance | | | | | | | | | | | | | | |
| Specified Value | NRV20/30Type, NRH24/30Type NRS20/30/40/50/60/80Type | Within the specified tolerance | | | | | | | | | | | | |
| Test Methods and Remarks | Measuring equipment : DC ohmmeter (HIOKI 3227 or equivalent) | | | | | | | | | | | | | |
| 6. Self resonance frequency | | | | | | | | | | | | | | |
| Specified Value | NRV30Type, NRH24/30Type NRS30/40/50/60/80Type | Within the specified tolerance | | | | | | | | | | | | |
| | NRV20, NRS20 | — | | | | | | | | | | | | |
| Test Methods and Remarks | NRV30, NRH24/30, NRS30/40/50/60/80Type Measuring equipment : Impedance analyzer/material analyzer (HP4291A or equivalent HP4191A, 4192A or equivalent) | | | | | | | | | | | | | |
| 7. Temperature characteristic | | | | | | | | | | | | | | |
| Specified Value | NRV20/30Type, NRH24/30Type NRS20/30/40/50/60/80Type | Inductance change : Within ±20% | | | | | | | | | | | | |
| Test Methods and Remarks | NRV20/30, NRH24/30, NRS20/30/40/50/60/80 Type, : Measurement of inductance shall be taken at temperature range within -40°C~+85°C. With reference to inductance value at +20°C., change rate shall be calculated. | | | | | | | | | | | | | |
| | Change of maximum inductance deviation in step 1 to 5 | | | | | | | | | | | | | |
| | <table border="1"> <thead> <tr> <th>Step</th> <th>Temperature (°C)</th> </tr> </thead> <tbody> <tr> <td>1</td> <td>20</td> </tr> <tr> <td>2</td> <td>Minimum operating temperature</td> </tr> <tr> <td>3</td> <td>20 (Standard temperature)</td> </tr> <tr> <td>4</td> <td>Maximum operating temperature</td> </tr> <tr> <td>5</td> <td>20</td> </tr> </tbody> </table> | Step | Temperature (°C) | 1 | 20 | 2 | Minimum operating temperature | 3 | 20 (Standard temperature) | 4 | Maximum operating temperature | 5 | 20 | |
| Step | Temperature (°C) | | | | | | | | | | | | | |
| 1 | 20 | | | | | | | | | | | | | |
| 2 | Minimum operating temperature | | | | | | | | | | | | | |
| 3 | 20 (Standard temperature) | | | | | | | | | | | | | |
| 4 | Maximum operating temperature | | | | | | | | | | | | | |
| 5 | 20 | | | | | | | | | | | | | |

▶ This catalog contains the typical specification only due to the limitation of space. When you consider the purchase of our products, please check our specification.
For details of each product (characteristics graph, reliability information, precautions for use, and so on), see our Web site (<http://www.ty-top.com/>).

| 14. Solderability | | | | | | | | | | | | | | | | | | | |
|----------------------------------|--|--|-----------------------|----------|-----------------|--|------------------|----------------|-----------------|-------|------|---|------------------|----------|---|-------|------|---|------------------|
| Specified Value | NRV20/30Type,NRH24/30Type NRS20/30/40/50/60/80Type | At least 90% of surface of terminal electrode is covered by new solder. | | | | | | | | | | | | | | | | | |
| Test Methods and Remarks | The test samples shall be dipped in flux, and then immersed in molten solder as shown in below table. Flux : Methanol solution containing rosin 25%. | | | | | | | | | | | | | | | | | | |
| | <table border="1"> <tr> <td>Solder Temperature</td> <td>245±5°C</td> </tr> <tr> <td>Time</td> <td>5±1.0 sec.</td> </tr> </table> | Solder Temperature | 245±5°C | Time | 5±1.0 sec. | ※Immersion depth : All sides of mounting terminal shall be immersed. | | | | | | | | | | | | | |
| Solder Temperature | 245±5°C | | | | | | | | | | | | | | | | | | |
| Time | 5±1.0 sec. | | | | | | | | | | | | | | | | | | |
| 15. Resistance to soldering heat | | | | | | | | | | | | | | | | | | | |
| Specified Value | NRV20/30Type,NRH24/30Type NRS20/30/40/50/60/80Type | Inductance change : Within ±10% No significant abnormality in appearance. | | | | | | | | | | | | | | | | | |
| Test Methods and Remarks | The test sample shall be exposed to reflow oven at 230±5°C for 40 seconds, with peak temperature at 260±5°C for 5 seconds, 2 times. Test board material : glass epoxy-resin Test board thickness : 1.0mm | | | | | | | | | | | | | | | | | | |
| 16. Thermal shock | | | | | | | | | | | | | | | | | | | |
| Specified Value | NRV20/30Type,NRH24/30Type NRS20/30/40/50/60/80Type | Inductance change : Within ±10% No significant abnormality in appearance. | | | | | | | | | | | | | | | | | |
| Test Methods and Remarks | The test samples shall be soldered to the test board by the reflow. The test samples shall be placed at specified temperature for specified time by step 1 to step 4 as shown in below table in sequence. The temperature cycle shall be repeated 1000 cycles. | | | | | | | | | | | | | | | | | | |
| | <table border="1"> <thead> <tr> <th colspan="3">Conditions of 1 cycle</th> </tr> <tr> <th>Step</th> <th>Temperature (°C)</th> <th>Duration (min)</th> </tr> </thead> <tbody> <tr> <td>1</td> <td>-40±3</td> <td>30±3</td> </tr> <tr> <td>2</td> <td>Room temperature</td> <td>Within 3</td> </tr> <tr> <td>3</td> <td>+85±2</td> <td>30±3</td> </tr> <tr> <td>4</td> <td>Room temperature</td> <td>Within 3</td> </tr> </tbody> </table> | | Conditions of 1 cycle | | | Step | Temperature (°C) | Duration (min) | 1 | -40±3 | 30±3 | 2 | Room temperature | Within 3 | 3 | +85±2 | 30±3 | 4 | Room temperature |
| Conditions of 1 cycle | | | | | | | | | | | | | | | | | | | |
| Step | Temperature (°C) | Duration (min) | | | | | | | | | | | | | | | | | |
| 1 | -40±3 | 30±3 | | | | | | | | | | | | | | | | | |
| 2 | Room temperature | Within 3 | | | | | | | | | | | | | | | | | |
| 3 | +85±2 | 30±3 | | | | | | | | | | | | | | | | | |
| 4 | Room temperature | Within 3 | | | | | | | | | | | | | | | | | |
| 17. Damp heat | | | | | | | | | | | | | | | | | | | |
| Specified Value | NRV20/30Type,NRH24/30Type NRS20/30/40/50/60/80Type | Inductance change : Within ±10% No significant abnormality in appearance. | | | | | | | | | | | | | | | | | |
| Test Methods and Remarks | The test samples shall be soldered to the test board by the reflow. The test samples shall be placed in thermostatic oven set at specified temperature and humidity as shown in below table. | | | | | | | | | | | | | | | | | | |
| | <table border="1"> <tr> <td>Temperature</td> <td>60±2°C</td> </tr> <tr> <td>Humidity</td> <td>90~95%RH</td> </tr> <tr> <td>Time</td> <td>1000+24/-0 hour</td> </tr> </table> | Temperature | 60±2°C | Humidity | 90~95%RH | Time | 1000+24/-0 hour | | | | | | | | | | | | |
| Temperature | 60±2°C | | | | | | | | | | | | | | | | | | |
| Humidity | 90~95%RH | | | | | | | | | | | | | | | | | | |
| Time | 1000+24/-0 hour | | | | | | | | | | | | | | | | | | |
| 18. Loading under damp heat | | | | | | | | | | | | | | | | | | | |
| Specified Value | NRV20/30Type,NRH24/30Type NRS20/30/40/50/60/80Type | Inductance change : Within ±10% No significant abnormality in appearance. | | | | | | | | | | | | | | | | | |
| Test Methods and Remarks | The test samples shall be soldered to the test board by the reflow. The test samples shall be placed in thermostatic oven set at specified temperature and humidity and applied the rated current continuously as shown in below table. | | | | | | | | | | | | | | | | | | |
| | <table border="1"> <tr> <td>Temperature</td> <td>60±2°C</td> </tr> <tr> <td>Humidity</td> <td>90~95%RH</td> </tr> <tr> <td>Applied current</td> <td>Rated current</td> </tr> <tr> <td>Time</td> <td>1000+24/-0 hour</td> </tr> </table> | Temperature | 60±2°C | Humidity | 90~95%RH | Applied current | Rated current | Time | 1000+24/-0 hour | | | | | | | | | | |
| Temperature | 60±2°C | | | | | | | | | | | | | | | | | | |
| Humidity | 90~95%RH | | | | | | | | | | | | | | | | | | |
| Applied current | Rated current | | | | | | | | | | | | | | | | | | |
| Time | 1000+24/-0 hour | | | | | | | | | | | | | | | | | | |
| 19. Low temperature life test | | | | | | | | | | | | | | | | | | | |
| Specified Value | NRV20/30Type,NRH24/30Type NRS20/30/40/50/60/80Type | Inductance change : Within ±10% No significant abnormality in appearance. | | | | | | | | | | | | | | | | | |
| Test Methods and Remarks | The test samples shall be soldered to the test board by the reflow. After that, the test samples shall be placed at test conditions as shown in below table. | | | | | | | | | | | | | | | | | | |
| | <table border="1"> <tr> <td>Temperature</td> <td>-40±2°C</td> </tr> <tr> <td>Time</td> <td>1000+24/-0 hour</td> </tr> </table> | Temperature | -40±2°C | Time | 1000+24/-0 hour | | | | | | | | | | | | | | |
| Temperature | -40±2°C | | | | | | | | | | | | | | | | | | |
| Time | 1000+24/-0 hour | | | | | | | | | | | | | | | | | | |

▶ This catalog contains the typical specification only due to the limitation of space. When you consider the purchase of our products, please check our specification.
For details of each product (characteristics graph, reliability information, precautions for use, and so on), see our Web site (<http://www.ty-top.com/>).

20. High temperature life test

| | | |
|-----------------|---|---|
| Specified Value | NRV20/30Type,NRH24/30Type NRS20/30/40/50/60/80Type | — |
|-----------------|---|---|

21. Loading at high temperature life test

| | | |
|-----------------|---|--|
| Specified Value | NRV20/30Type,NRH24/30Type NRS20/30/40/50/60/80Type | Inductance change : Within $\pm 10\%$ No significant abnormality in appearance. |
|-----------------|---|--|

| | | |
|--------------------------|---|--------------------------|
| Test Methods and Remarks | The test samples shall be soldered to the test board by the reflow soldering. | |
| | Temperature | $85 \pm 2^\circ\text{C}$ |
| | Applied current | Rated current |
| | Time | $1000 + 24 / - 0$ hour |

22. Standard condition

| | | |
|-----------------|---|--|
| Specified Value | NRV20/30Type,NRH24/30Type NRS20/30/40/50/60/80Type | Standard test condition : Unless otherwise specified, temperature is $20 \pm 15^\circ\text{C}$ and $65 \pm 20\%$ of relative humidity. When there is any question concerning measurement result: In order to provide correlation data, the test shall be condition of $20 \pm 2^\circ\text{C}$ of temperature, $65 \pm 5\%$ relative humidity. Inductance is in accordance with our measured value. |
|-----------------|---|--|

SMD POWER INDUCTORS (NR, NS, ES SERIES)

PRECAUTIONS

1. Circuit Design

| | |
|-------------|---|
| Precautions | <p>◆ Operating environment</p> <p>1. The products listed in this catalogue are intended for use in general electronic equipment (e.g., AV equipment, OA equipment, home electric appliances, office equipment, information and communication equipment), general medical equipment, industrial equipment, and automotive interior applications, etc.</p> <p>Please be sure to contact TAIYO YUDEN for further information before using the products for any equipment which may directly cause loss of human life or bodily injury (e.g., specially controlled medical equipment, transportation equipment including, without limitation, automotive powertrain control system, train control system, and ship control system, traffic signal equipment).</p> <p>Please do not incorporate our products into any equipment requiring high levels of safety and/or reliability (e.g., aerospace equipment, aviation equipment, nuclear control equipment, undersea equipment, military equipment, etc.).</p> |
|-------------|---|

2. PCB Design

| | |
|-------------|---|
| Precautions | <p>◆ Land pattern design</p> <p>1. Please refer to a recommended land pattern.</p> <p>2. There is stress, which has been caused by distortion of a PCB, to the inductor. (NRV20/30, NRH24/30, NRS20/30/40/50/60/80, NRM60 Type)</p> <p>3. Please consider the arrangement of parts on a PCB. (NRV20/30, NRH24/30, NRS20/30/40/50/60/80, NRM60 Type)</p> |
|-------------|---|

| | |
|--------------------------|---|
| Technical considerations | <p>◆ Land pattern design</p> <p>Surface Mounting</p> <p>1. Mounting and soldering conditions should be checked beforehand.</p> <p>2. Applicable soldering process to this products is reflow soldering only.</p> <p>3. Please use the recommended land pattern shown as below. Electrical characteristics and the mounting ability of the product are being considered in the recommended land pattern. If a PCB is designed with other dimensions, defective soldering and stress to a product may occur due to misalignment. The performance of the product may not be brought out. If an adopted land pattern is different from the recommended land pattern, stress to the product will increase. It may cause cracks or defective electrical characteristics of the product. Please conduct validation completely before studying adoption of this product and please judge the pros and cons of adoption of this product with taking on responsibility. (NR30/40/50/60/80, NRV20/30, NRH24/30, NRS20/30/40/50/60/80, NRM60 Type)</p> <p>4. As coefficients of thermal expansion between an inductor and a PCB differs, cracks may occur on a ferrite core when thermal stress is applied to them after mounting an inductor. (Please refer to the drawings below.) Please conduct validation completely before studying adoption of this product and please judge the pros and cons of adoption of this product with taking on responsibility. (NRV20/30, NRH24/30, NRS20/30/40/50/60/80, NRM60 Type)</p> |
|--------------------------|---|

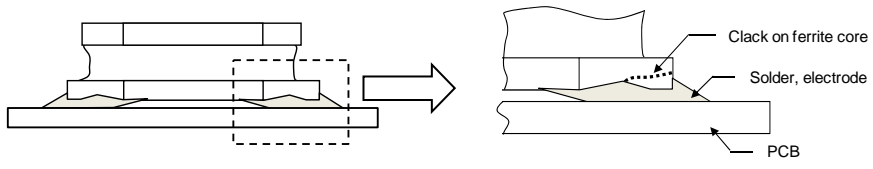

5. SMD inductors should be located to minimize any possible mechanical stresses from board warp or deflection. When splitting the PCB board after mounting inductors and other components, care is required so as not to give any stresses of deflection or twisting to the board. (NRV20/30, NRH24/30, NRS20/30/40/50/60/80, NRM60 Type)

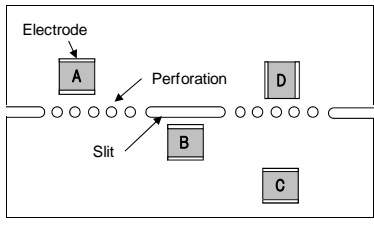

A product tends to undergo stress in order "A>C>B≡D". Please consider the layouts of a product to minimize any stresses.

▶ This catalog contains the typical specification only due to the limitation of space. When you consider the purchase of our products, please check our specification. For details of each product (characteristics graph, reliability information, precautions for use, and so on), see our Web site (<http://www.ty-top.com/>)

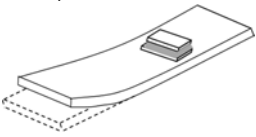
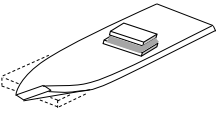
| 3. Considerations for automatic placement | |
|---|--|
| Precautions | <p>◆Adjustment of mounting machine</p> <ol style="list-style-type: none"> Excessive impact load should not be imposed on the products when mounting onto the PC boards. Mounting and soldering conditions should be checked beforehand. |
| Technical considerations | <p>◆Adjustment of mounting machine</p> <ol style="list-style-type: none"> When installing products, care should be taken not to apply distortion stress as it may deform the products. Stress may be applied to a product with a warp or a twist in handling of the product. Please conduct validation completely before studying adoption of this product and please judge the pros and cons of adoption of this product with taking on responsibility. (NRV20/30, NRH24/30, NRS20/30/40/50/60/80, NRM60 Type) <div style="display: flex; justify-content: space-around; align-items: center;"> <div style="text-align: center;"> <p><Wrap></p>  </div> <div style="text-align: center;"> <p><Twist></p>  </div> </div> |

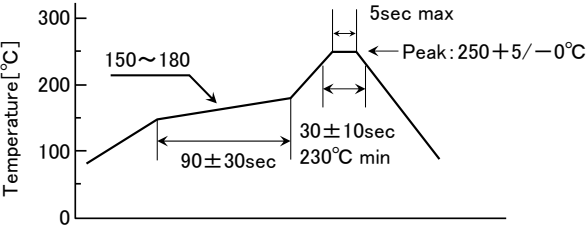
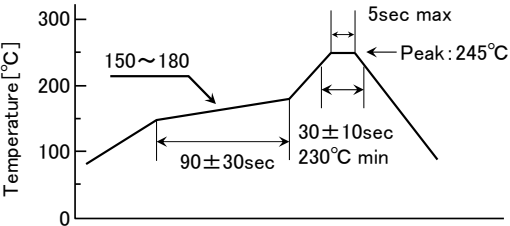
| 4. Soldering | |
|--------------------------|---|
| Precautions | <p>◆Reflow soldering</p> <ol style="list-style-type: none"> Please contact any of our offices for a reflow soldering, and refer to the recommended condition specified. The product shall be used reflow soldering only. Please do not add any stress to a product until it returns in normal temperature after reflow soldering. <p>◆Lead free soldering</p> <ol style="list-style-type: none"> When using products with lead free soldering, we request to use them after confirming adhesion, temperature of resistance to soldering heat, soldering etc sufficiently. <p>◆Recommended conditions for using a soldering iron</p> <ul style="list-style-type: none"> Put the soldering iron on the land-pattern. Soldering iron's temperature - Below 350°C Duration - 3 seconds or less The soldering iron should not directly touch the inductor. |
| Technical considerations | <p>◆Reflow soldering</p> <ol style="list-style-type: none"> If products are used beyond the range of the recommended conditions, heat stresses may deform the products, and consequently degrade the reliability of the products. <ul style="list-style-type: none"> NRV20/30, NRH24/30, NRS20/30/40/50/60/80, NRM60 Type, NS101/125 Type, EST0645/1040/1060 Type <p>Recommended reflow condition (Pb free solder)</p> <p><u>NR, NS Series</u></p>  <p><u>ES Series</u></p>  |

| 5. Cleaning | |
|--------------------------|--|
| Precautions | <p>◆Cleaning conditions</p> <ol style="list-style-type: none"> Washing by supersonic waves shall be avoided. |
| Technical considerations | <p>◆Cleaning conditions</p> <ol style="list-style-type: none"> If washed by supersonic waves, the products might be broken. |

6. Handling

▶ This catalog contains the typical specification only due to the limitation of space. When you consider the purchase of our products, please check our specification. For details of each product (characteristics graph, reliability information, precautions for use, and so on), see our Web site (<http://www.ty-top.com/>)

| | |
|--------------------------|--|
| Precautions | <ul style="list-style-type: none"> ◆ Handling <ol style="list-style-type: none"> 1. Keep the product away from all magnets and magnetic objects. ◆ Breakaway PC boards (splitting along perforations) <ol style="list-style-type: none"> 1. When splitting the PC board after mounting product, care should be taken not to give any stresses of deflection or twisting to the board. 2. Board separation should not be done manually, but by using the appropriate devices. ◆ Mechanical considerations <ol style="list-style-type: none"> 1. Please do not give the product any excessive mechanical shocks. 2. Please do not add any shock and power to a product in transportation. ◆ Pick-up pressure <ol style="list-style-type: none"> 1. Please do not push to add any pressure to a winding part. Please do not give any shock and push into a ferrite core exposure part. ◆ Packing <ol style="list-style-type: none"> 1. Please avoid accumulation of a packing box as much as possible. |
| Technical considerations | <ul style="list-style-type: none"> ◆ Handling <ol style="list-style-type: none"> 1. There is a case that a characteristic varies with magnetic influence. ◆ Breakaway PC boards (splitting along perforations) <ol style="list-style-type: none"> 1. The position of the product on PCBs shall be carefully considered to minimize the stress caused from splitting of the PCBs. ◆ Mechanical considerations <ol style="list-style-type: none"> 1. There is a case to be damaged by a mechanical shock. 2. There is a case to be broken by the handling in transportation. ◆ Pick-up pressure <ol style="list-style-type: none"> 1. Damage and a characteristic can vary with an excessive shock or stress. ◆ Packing <ol style="list-style-type: none"> 1. If packing boxes are accumulated, that could cause a deformation on packing tapes or a damage on the products. |

7. Storage conditions

| | |
|--------------------------|---|
| Precautions | <ul style="list-style-type: none"> ◆ Storage <ol style="list-style-type: none"> 1. To maintain the solderability of terminal electrodes and to keep the packing material in good condition, temperature and humidity in the storage area should be controlled. <ul style="list-style-type: none"> ▪ Recommended conditions <ul style="list-style-type: none"> Ambient temperature : $-5\sim 40^{\circ}\text{C}$ Humidity : Below 70% RH ▪ The ambient temperature must be kept below 30°C. Even under ideal storage conditions, solderability of products electrodes may decrease as time passes. <ul style="list-style-type: none"> For this reason, product should be used within 6 months from the time of delivery. In case of storage over 6 months, solderability shall be checked before actual usage. |
| Technical considerations | <ul style="list-style-type: none"> ◆ Storage <ol style="list-style-type: none"> 1. Under a high temperature and humidity environment, problems such as reduced solderability caused by oxidation of terminal electrodes and deterioration of taping/packaging materials may take place. |